

RoHS Compliant Product

SOT-363

FEATURE

- Epitaxial Die Construction
- Two internal isolated NPN/PNP transistors in one package
- Power Dissipation
 $P_{CM} : 0.2 \text{ W (Temp. = } 25^{\circ}\text{C)}$
- Collector Current
 $I_{CM} : 0.1\text{A}$
- Collector-base Voltage
 $V_{(BR)CBO} : 50/-50 \text{ V}$
- Operating & Storage Junction Temperature
 $T_J, T_{STG} : -55^{\circ}\text{C} \sim +150^{\circ}\text{C}$

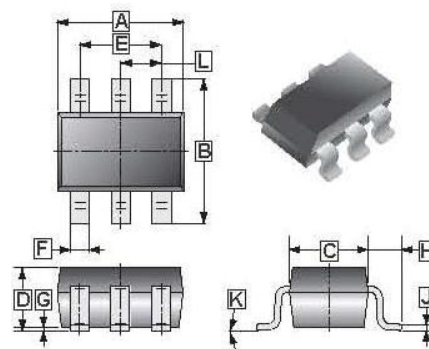

MARKING

7P

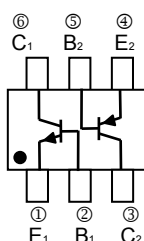

REF.	Millimeter		REF.	Millimeter	
	Min.	Max.		Min.	Max.
A	2.00	2.20	G	0.100	REF.
B	2.15	2.45	H	0.525	REF.
C	1.15	1.35	J	0.08	0.15
D	0.90	1.10	K	8°	
E	1.20	1.40	L	0.650 TYP.	
F	0.15	0.35			

ABSOLUTE MAXIMUM RATINGS OF TR1 at $T_a = 25^{\circ}\text{C}$

PARAMETER	SYMBOL	VALUE	UNITS
Collector to Base Voltage	V_{CBO}	50	V
Collector to Emitter Voltage	V_{CEO}	45	V
Emitter to Base Voltage	V_{EBO}	6	V
Collector Current – Continuous	I_C	100	mA
Collector Power Dissipation	P_C	200	mW
Junction Temperature	T_J	150	$^{\circ}\text{C}$
Storage Temperature	T_{STG}	-55 ~ +150	$^{\circ}\text{C}$

ELECTRICAL CHARACTERISTICS OF TR1 (NPN Transistor) at $T_a = 25^{\circ}\text{C}$

CHARACTERISTIC	TEST CONDITION	SYMBOL	MIN.	TYP.	MAX.	UNIT
Collector-Base Breakdown Voltage	$I_C=10\mu\text{A}, I_E=0$	$V_{(BR)CBO}$	50			V
Collector-Emitter Breakdown Voltage	$I_C = 10 \text{ mA}, I_B = 0$	$V_{(BR)CEO}$	45			V
Emitter-Base Breakdown Voltage	$I_E=1\mu\text{A}, I_C=0$	$V_{(BR)EBO}$	6			V
Collector Cutoff Current	$V_{CB}=30\text{V}, I_E=0$	I_{CBO}			15	nA
Emitter Cutoff Current	$V_{EB}=5\text{V}, I_C=0$	I_{EBO}			15	nA
DC Current Gain	$V_{CE}=5\text{V}, I_C=2\text{mA}$	h_{FE}	200		450	
Collector-emitter Saturation Voltage	$I_C=10\text{mA}, I_B=0.5\text{mA}$	$V_{CE(sat)}$			0.25	V
	$I_C=100\text{mA}, I_B=5\text{mA}$	$V_{CE(sat)}$			0.6	V
Base-Emitter Saturation Voltage	$I_C=10\text{mA}, I_B=0.5\text{mA}$	$V_{BE(sat)}$		0.7		V
	$I_C=100\text{mA}, I_B=5\text{mA}$	$V_{BE(sat)}$		0.9		V
Base-Emitter Voltage	$I_C=10\text{mA}, V_{CE}=5\text{V}$	$V_{BE(On)}$	0.58		0.7	V
	$I_C=10\text{mA}, V_{CE}=5\text{V}$	$V_{BE(On)}$			0.72	V
Collector Output Capacitance	$V_{CB}=10\text{V}, I_E=0, f=1\text{MHz}$	C_{ob}			6.0	pF
Transition Frequency	$V_{CE}=5\text{V}, I_C=10\text{mA}, f=100\text{MHz}$	f_T	100			MHz
Noise Figure	$V_{CE}=5\text{V}, I_C=0.2\text{mA}, f=1\text{kHz}$ $R_g=2\text{K}\Omega, \Delta f=200\text{Hz}$	NF			10	dB

ABSOLUTE MAXIMUM RATINGS OF TR2 at Ta = 25°C

PARAMETER	SYMBOL	VALUE	UNITS
Collector to Base Voltage	V_{CBO}	-50	V
Collector to Emitter Voltage	V_{CEO}	-45	V
Emitter to Base Voltage	V_{EBO}	-5	V
Collector Current – Continuous	I_C	-100	mA
Collector Power Dissipation	P_C	200	mW
Junction Temperature	$R_{\theta JA}$	150	°C
Storage Temperature	T_{STG}	-55 ~ -150	°C

ELECTRICAL CHARACTERISTICS OF TR2 (PNP Transister) at Ta = 25°C

CHARACTERISTIC	TEST CONDITION	SYMBOL	MIN.	TYP.	MAX.	UNIT
Collector-Base Breakdown Voltage	$I_C = -10\mu A, I_E = 0$	$V_{(BR)CBO}$	-50			V
Collector-Emitter Breakdown Voltage	$I_C = -10 mA, I_B = 0$	$V_{(BR)CEO}$	-45			V
Emitter-Base Breakdown Voltage	$I_E = -1\mu A, I_C = 0$	$V_{(BR)EBO}$	-5			V
Collector Cutoff Current	$V_{CB} = -30V, I_E = 0$	I_{CBO}			-15	nA
Emitter Cutoff Current	$V_{EB} = -5V, I_C = 0$	I_{EBO}			-15	nA
DC Current Gain	$V_{CE} = -5V, I_C = -2mA$	h_{FE}	220		475	
Collector-emitter Saturation Voltage	$I_C = -10mA, I_B = -0.5mA$	$V_{CE(sat)}$			-0.3	V
	$I_C = -100mA, I_B = -5mA$	$V_{CE(sat)}$			-0.65	V
Base-Emitter Saturation Voltage	$I_C = -10mA, I_B = -0.5mA$	$V_{BE(sat)}$		-0.7		V
	$I_C = -100mA, I_B = -5mA$	$V_{BE(sat)}$			-0.95	V
Base-Emitter Voltage	$I_C = -2mA, V_{CE} = -5V$	$V_{BE(On)}$	-0.6		-0.75	V
	$I_C = -10mA, V_{CE} = -5V$	$V_{BE(On)}$			-0.82	V
Collector Output Capacitance	$V_{CB} = -10V, I_E = 0, f = 1MHz$	C_{ob}			4.5	pF
Transition Frequency	$V_{CE} = -5V, I_C = -10mA, f = 100MHz$	f_T	100			MHz
Noise Figure	$V_{CE} = -5V, I_C = -0.2mA, f = 1kHz$ $R_g = 2K\Omega, \Delta f = 200Hz$	NF			10	dB

CHARACTERISTIC CURVES

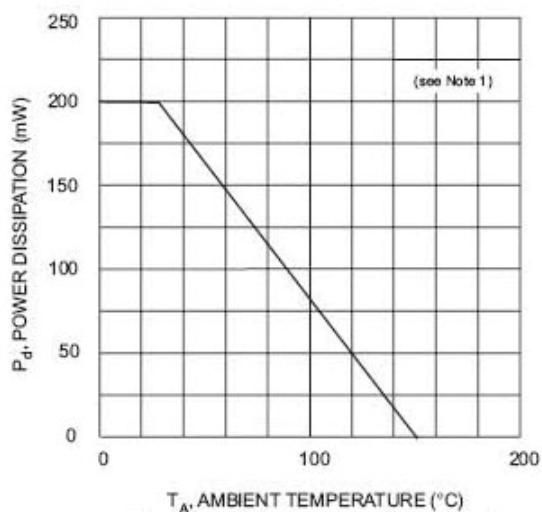

Fig. 1, Power Derating Curve (Total Device)

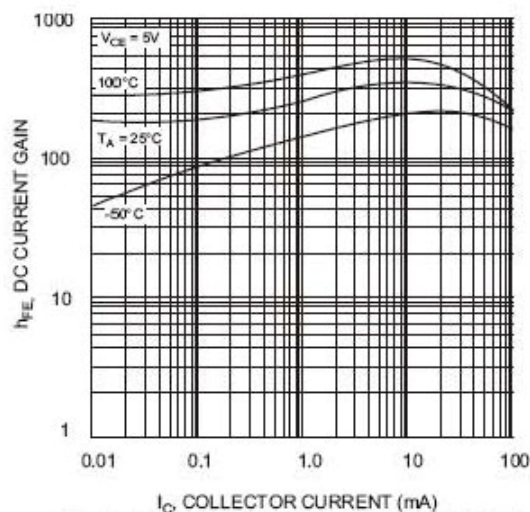

Fig. 2, DC Current Gain vs Collector Current (BC847B)

CHARACTERISTIC CURVES

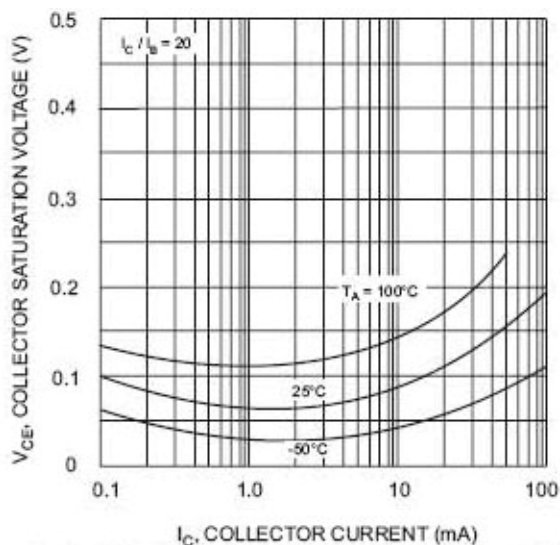

Fig. 3, Collector Saturation Voltage vs Collector Current (BC847B)

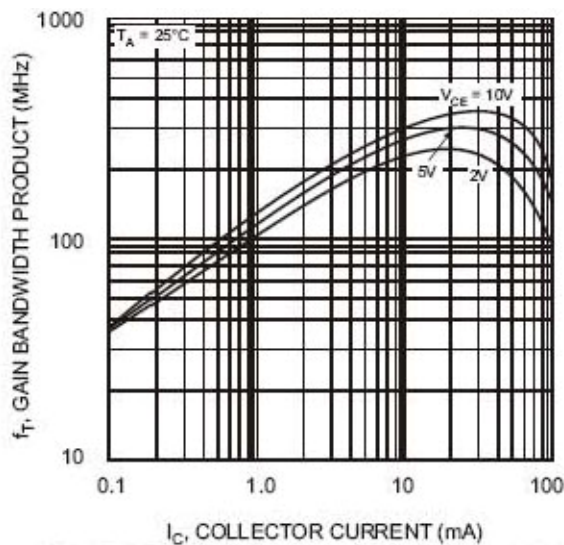

Fig. 4, Gain Bandwidth Product vs Collector Current (BC847B)

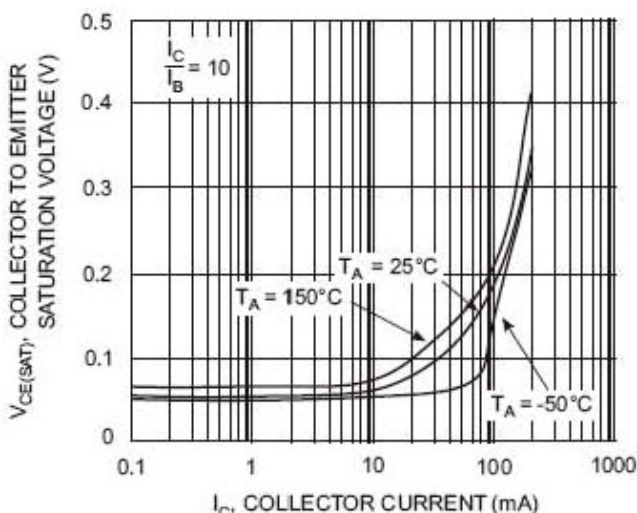

Fig. 5, Collector Emitter Saturation Voltage vs. Collector Current (BC857B)

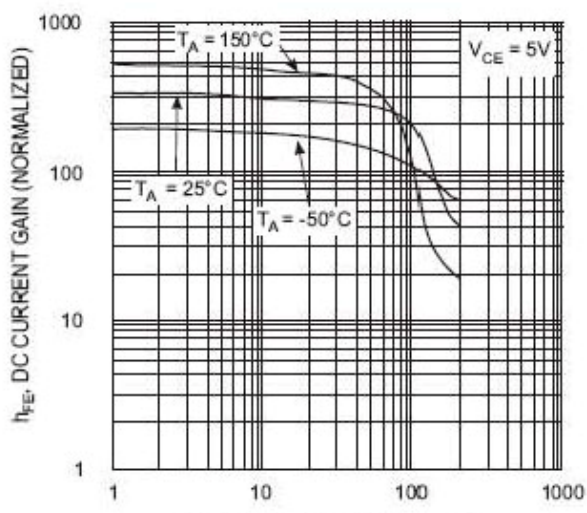

Fig. 6, DC Current Gain vs. Collector Current (BC857B)

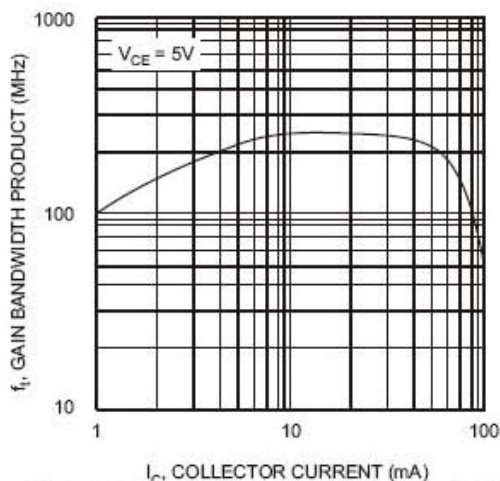

Fig. 7, Gain Bandwidth Product vs Collector Current (BC857B)