

# BCR12UM

MEDIUM POWER USE  
INSULATED TYPE, GLASS PASSIVATION TYPE

**BCR12UM**

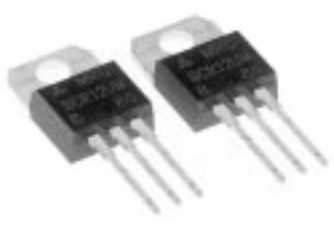

- IT (RMS) ..... 12A
- VDRM ..... 400V/600V
- IFGT I, IRGT I, IRGT III ..... 15mA
- V<sub>iso</sub> ..... 1500V

**OUTLINE DRAWING** Dimensions  
in mm

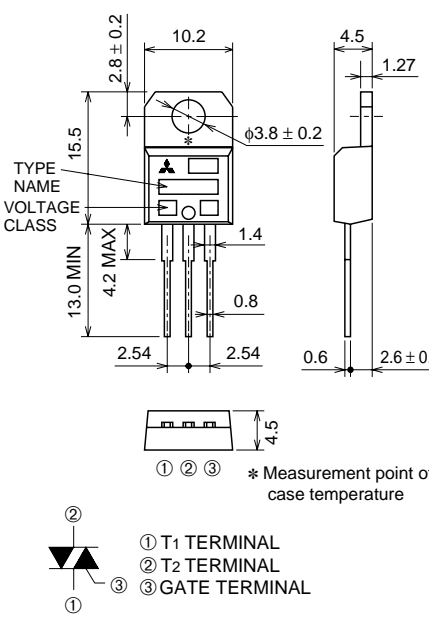

TYPE NAME  
VOLTAGE CLASS

① ② ③ \* Measurement point of case temperature

① T1 TERMINAL  
② T2 TERMINAL  
③ GATE TERMINAL

TO-220

## APPLICATION

Light dimmer

## MAXIMUM RATINGS

Symbol	Parameter	Voltage class		Unit
		8	12	
VDRM	Repetitive peak off-state voltage*1	400	600	V
VDSM	Non-repetitive peak off-state voltage*1	500	720	V

Symbol	Parameter	Conditions	Ratings	Unit
IT (RMS)	RMS on-state current	Commercial frequency, sine full wave 360° conduction, T <sub>c</sub> =84°C*3	12	A
ITSM	Surge on-state current	60Hz sinewave 1 full cycle, peak value, non-repetitive	120	A
I <sup>2</sup> <sub>t</sub>	I <sup>2</sup> <sub>t</sub> for fusing	Value corresponding to 1 cycle of half wave 60Hz, surge on-state current	60	A <sup>2</sup> s
PGM	Peak gate power dissipation		5	W
PG (AV)	Average gate power dissipation		0.5	W
VGM	Peak gate voltage		10	V
IGM	Peak gate current		2	A
T <sub>j</sub>	Junction temperature		-40 ~ +125	°C
T <sub>stg</sub>	Storage temperature		-40 ~ +125	°C
—	Weight	Typical value	2.3	g
V <sub>iso</sub>	Isolation voltage	T <sub>a</sub> =25°C, AC 1 minute, T1 · T2 · G terminal to case	1500	V

\*1. Gate open.

# BCR12UM

MEDIUM POWER USE  
INSULATED TYPE, GLASS PASSIVATION TYPE

## ELECTRICAL CHARACTERISTICS

Symbol	Parameter	Test conditions	Limits			Unit	
			Min.	Typ.	Max.		
IDRM	Repetitive peak off-state current	$T_j=125^{\circ}\text{C}$ , $V_{\text{DRM}}$ applied	—	—	2.0	mA	
VTM	On-state voltage	$T_c=25^{\circ}\text{C}$ , $I_{\text{TM}}=20\text{A}$ , Instantaneous measurement	—	—	1.6	V	
VFGT I	Gate trigger voltage *2	$T_j=25^{\circ}\text{C}$ , $V_D=6\text{V}$ , $R_L=6\Omega$ , $R_G=330\Omega$	I	—	—	1.5	V
VRGT I			II	—	—	1.5	V
VRGT III			III	—	—	1.5	V
IFGT I	Gate trigger current *2	$T_j=25^{\circ}\text{C}$ , $V_D=6\text{V}$ , $R_L=6\Omega$ , $R_G=330\Omega$	I	—	—	15	mA
IRGT I			II	—	—	15	mA
IRGT III			III	—	—	15	mA
VGD	Gate non-trigger voltage	$T_j=125^{\circ}\text{C}$ , $V_D=1/2V_{\text{DRM}}$	0.2	—	—	V	
$R_{\text{th}}(j-c)$	Thermal resistance	Junction to case *3 *4	—	—	2.7	$^{\circ}\text{C/W}$	

\*2. Measurement using the gate trigger characteristics measurement circuit.  
 \*3. Case temperature is measured at the T2 terminal 1.5mm away from the molded case.  
 \*4. The contact thermal resistance  $R_{\text{th}}(c-f)$  in case of greasing is  $1.0^{\circ}\text{C/W}$ .

## PERFORMANCE CURVES

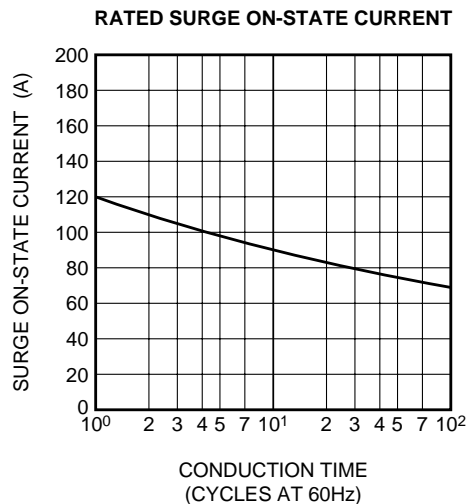
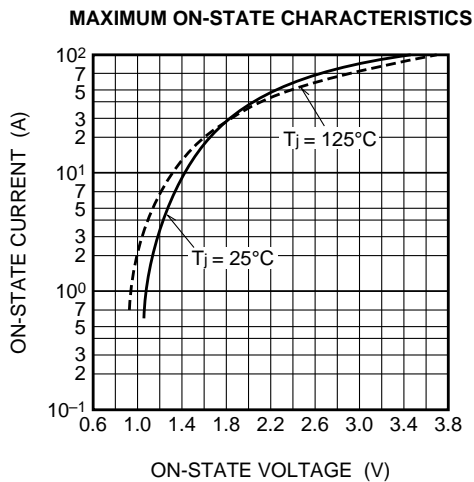

# BCR12UM

MEDIUM POWER USE  
INSULATED TYPE, GLASS PASSIVATION TYPE

**GATE CHARACTERISTICS**

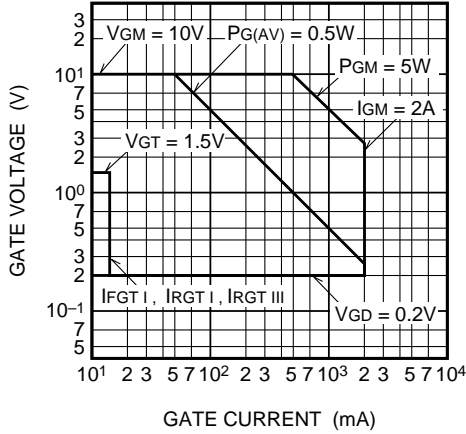

**GATE TRIGGER CURRENT VS. JUNCTION TEMPERATURE**

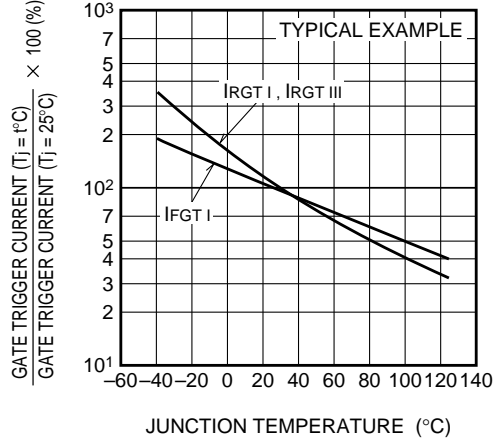

**GATE TRIGGER VOLTAGE VS. JUNCTION TEMPERATURE**

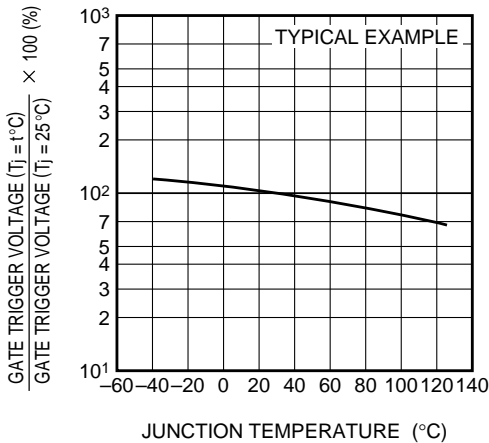

**MAXIMUM TRANSIENT THERMAL IMPEDANCE CHARACTERISTICS (JUNCTION TO CASE)**

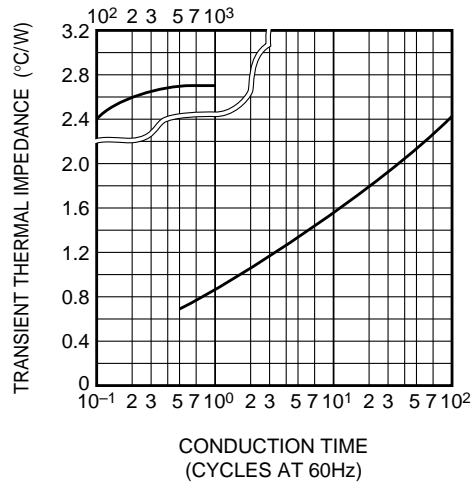

**MAXIMUM ON-STATE POWER DISSIPATION**

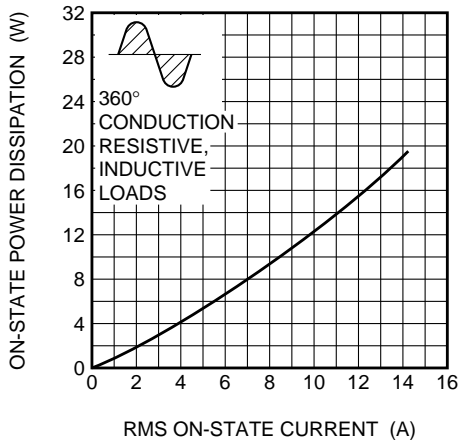

**ALLOWABLE CASE TEMPERATURE VS. RMS ON-STATE CURRENT**

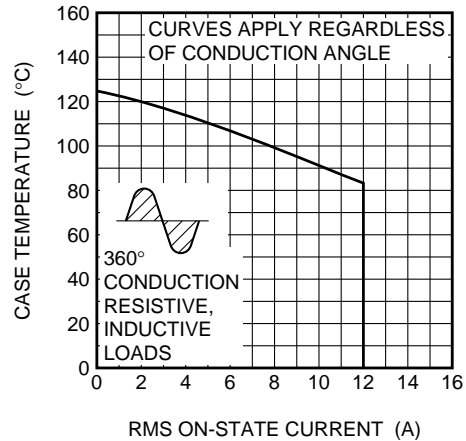

# BCR12UM

MEDIUM POWER USE  
INSULATED TYPE, GLASS PASSIVATION TYPE

**ALLOWABLE AMBIENT TEMPERATURE VS. RMS ON-STATE CURRENT**

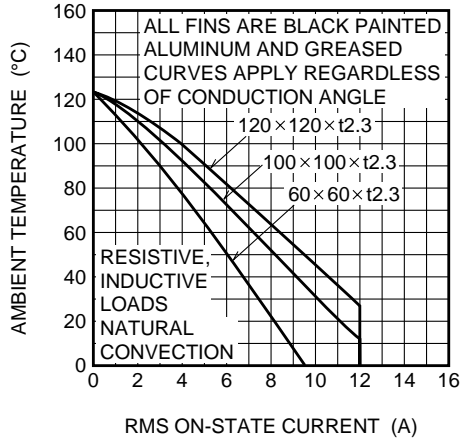

**ALLOWABLE AMBIENT TEMPERATURE VS. RMS ON-STATE CURRENT**

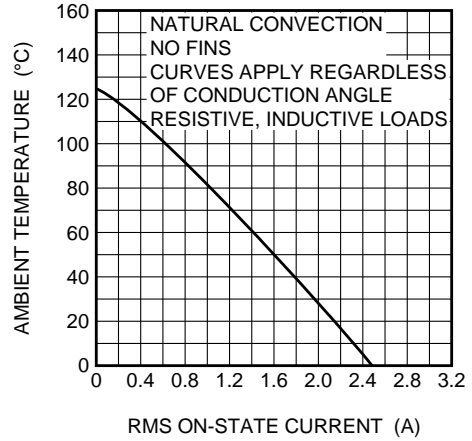

**REPETITIVE PEAK OFF-STATE CURRENT VS. JUNCTION TEMPERATURE**

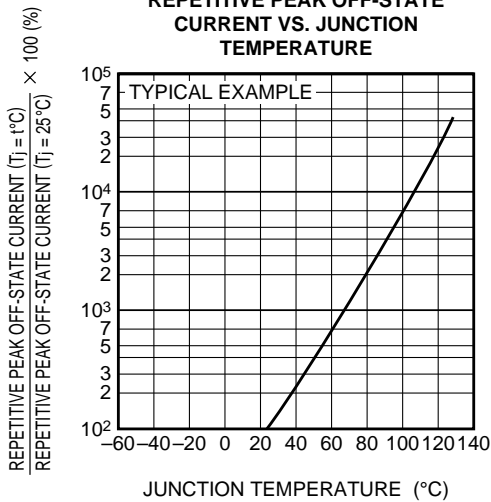

**HOLDING CURRENT VS. JUNCTION TEMPERATURE**

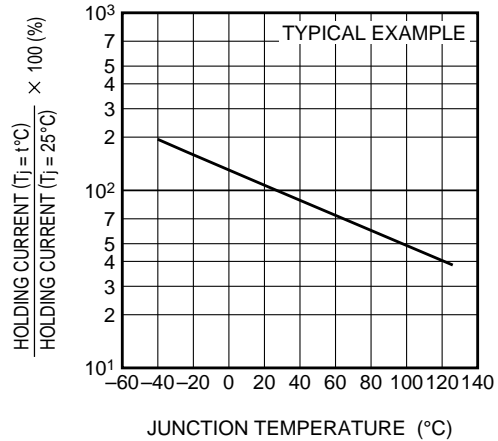

**LATCHING CURRENT VS. JUNCTION TEMPERATURE**

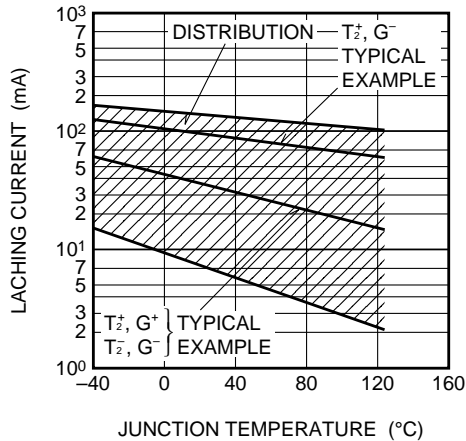

**BREAKOVER VOLTAGE VS. JUNCTION TEMPERATURE**

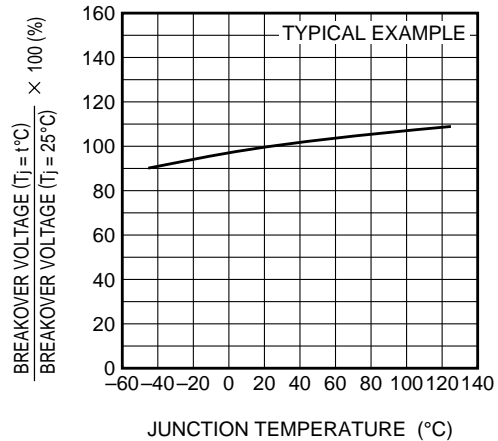

# BCR12UM

MEDIUM POWER USE  
INSULATED TYPE, GLASS PASSIVATION TYPE

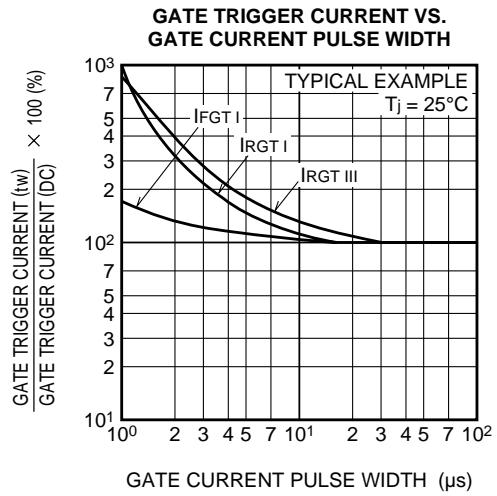
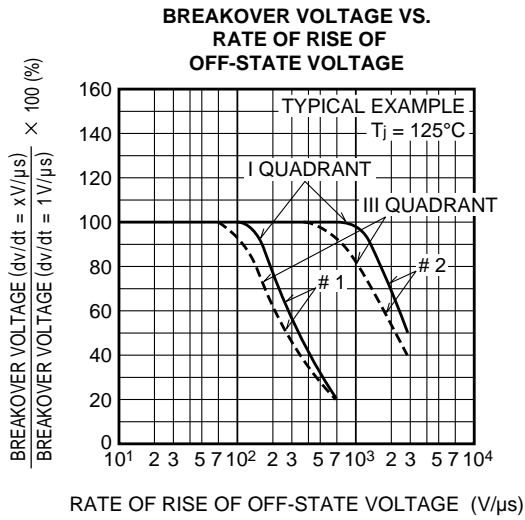

**GATE TRIGGER CHARACTERISTICS TEST CIRCUITS**

