

# BCR20AM

MEDIUM POWER USE  
NON-INSULATED TYPE, PLANAR PASSIVATION TYPE

**BCR20AM**



- $I_T$  (RMS) ..... 20A
- $V_{DRM}$  ..... 400V / 600V
- IFGT I, IRGT I, IRGT III ..... 30mA (20mA) \*5

**OUTLINE DRAWING** Dimensions in mm

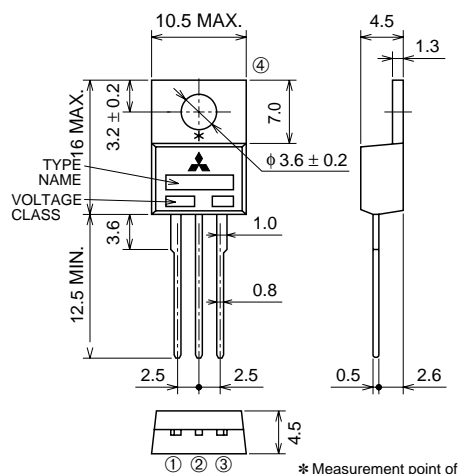

① T1 TERMINAL  
② T2 TERMINAL  
③ GATE TERMINAL  
④ T2 TERMINAL

**TO-220**

## APPLICATION

Vacuum cleaner, light dimmer, copying machine, other control of motor and heater

## MAXIMUM RATINGS

Symbol	Parameter	Voltage class		Unit
		8	12	
$V_{DRM}$	Repetitive peak off-state voltage*1	400	600	V
$V_{DSM}$	Non-repetitive peak off-state voltage*1	500	720	V

Symbol	Parameter	Conditions	Ratings	Unit
$I_T$ (RMS)	RMS on-state current	Commercial frequency, sine full wave, $T_c=105^\circ\text{C}$	20	A
$I_{TSM}$	Surge on-state current	60Hz sinewave 1 full cycle, peak value, non-repetitive	200	A
$I_t^2$	$I_t^2$ for fusing	Value corresponding to 1 cycle of half wave 60Hz, surge on-state current	167	$\text{A}^2\text{s}$
PGM	Peak gate power dissipation		5	W
$P_G$ (AV)	Average gate power dissipation		0.5	W
$V_{GM}$	Peak gate voltage		10	V
$I_{GM}$	Peak gate current		2	A
$T_j$	Junction temperature		-40 ~ +125	$^\circ\text{C}$
$T_{stg}$	Storage temperature		-40 ~ +125	$^\circ\text{C}$
—	Weight	Typical value	2.0	g

\*1. Gate open.

# BCR20AM

MEDIUM POWER USE

NON-INSULATED TYPE, PLANAR PASSIVATION TYPE

## ELECTRICAL CHARACTERISTICS

Symbol	Parameter	Test conditions	Limits			Unit	
			Min.	Typ.	Max.		
IDRM	Repetitive peak off-state current	T <sub>j</sub> =125°C, V <sub>DRM</sub> applied	—	—	2.0	mA	
VTM	On-state voltage	T <sub>c</sub> =25°C, I <sub>TM</sub> =30A, Instantaneous measurement	—	—	1.5	V	
VFGT I	Gate trigger voltage*2	T <sub>j</sub> =25°C, V <sub>D</sub> =6V, R <sub>L</sub> =6Ω, R <sub>G</sub> =330Ω *3	I	—	—	1.5	V
VRGT I			II	—	—	1.5	V
VRGT III			III	—	—	1.5	V
IFGT I	Gate trigger current*2	T <sub>j</sub> =25°C, V <sub>D</sub> =6V, R <sub>L</sub> =6Ω, R <sub>G</sub> =330Ω *3	I	—	—	30 *5	mA
IRGT I			II	—	—	30 *5	mA
IRGT III			III	—	—	30 *5	mA
VGD	Gate non-trigger voltage	T <sub>j</sub> =125°C, V <sub>D</sub> =1/2V <sub>DRM</sub>	0.2	—	—	V	
R <sub>th(j-c)</sub>	Thermal resistance	Junction to case *4	—	—	0.8	°C/W	
(dv/dt) <sub>c</sub>	Critical-rate of rise of off-state commutating voltage		*3	—	—	V/μs	

\*2. Measurement using the gate trigger characteristics measurement circuit.

\*3. The critical-rate of rise of the off-state commutating voltage is shown in the table below.

\*4. The contact thermal resistance R<sub>th(c-f)</sub> in case of greasing is 1°C/W.

\*5. High sensitivity (I<sub>GT</sub> ≤ 20mA) is also available. (I<sub>GT</sub> time ①)

Voltage class	V <sub>DRM</sub> (V)	(dv/dt) <sub>c</sub>			Test conditions	Commutating voltage and current waveforms (inductive load)
		Symbol	Min.	Unit		
8	400	R	—	V/μs	1. Junction temperature T <sub>j</sub> =125°C 2. Rate of decay of on-state commutating current (dv/dt) <sub>c</sub> =-10A/ms 3. Peak off-state voltage V <sub>D</sub> =400V	
		L	10			
12	600	R	—			
		L	10			

## PERFORMANCE CURVES

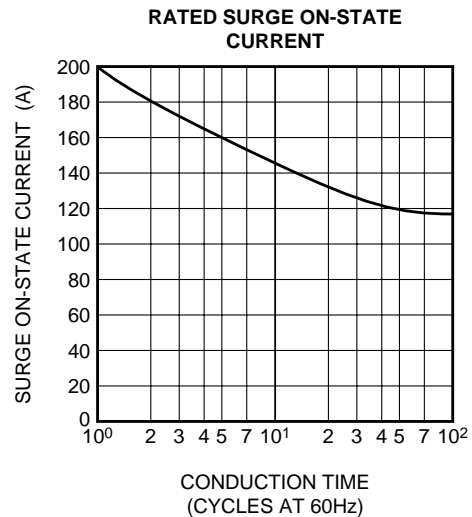
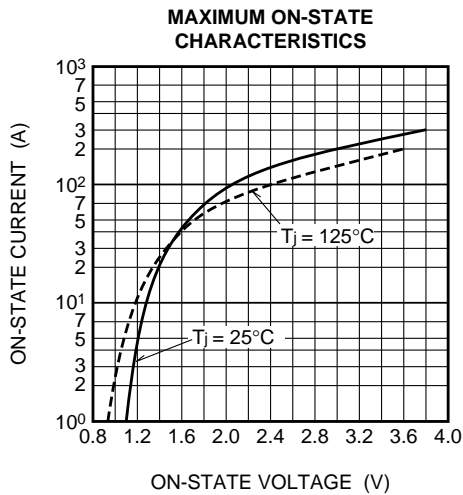

# BCR20AM

MEDIUM POWER USE  
NON-INSULATED TYPE, PLANAR PASSIVATION TYPE

**GATE CHARACTERISTICS  
(I, II AND III)**

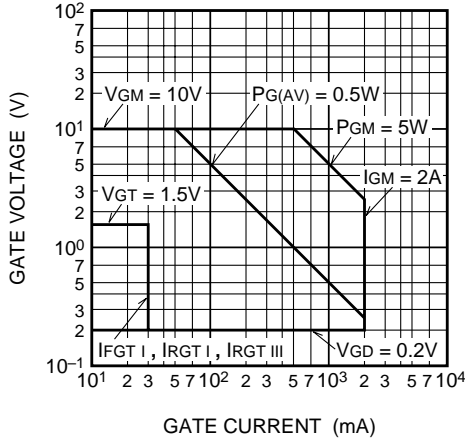

**GATE TRIGGER CURRENT VS.  
JUNCTION TEMPERATURE**

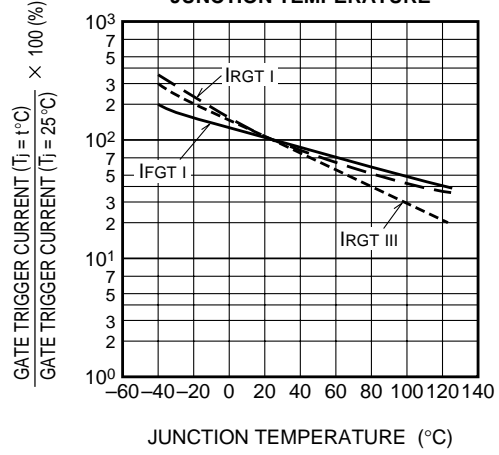

**GATE TRIGGER VOLTAGE VS.  
JUNCTION TEMPERATURE**

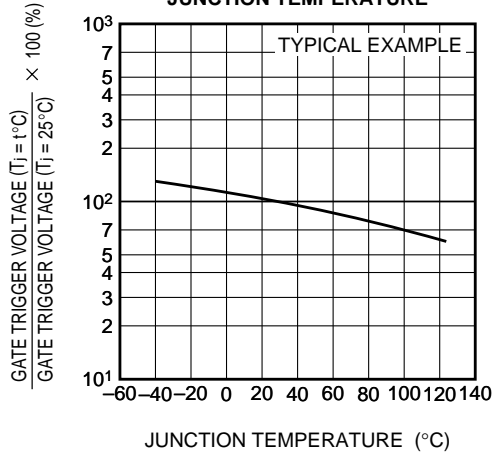

**MAXIMUM TRANSIENT THERMAL  
IMPEDANCE CHARACTERISTICS**

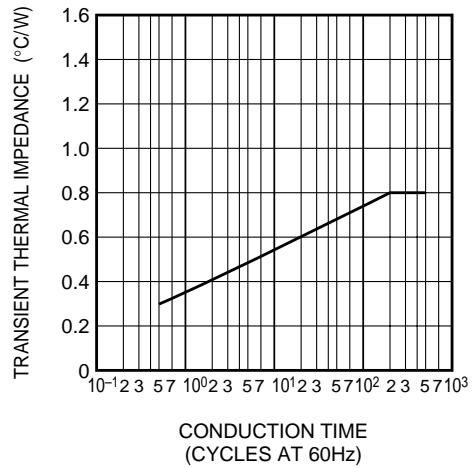

**MAXIMUM ON-STATE POWER  
DISSIPATION**

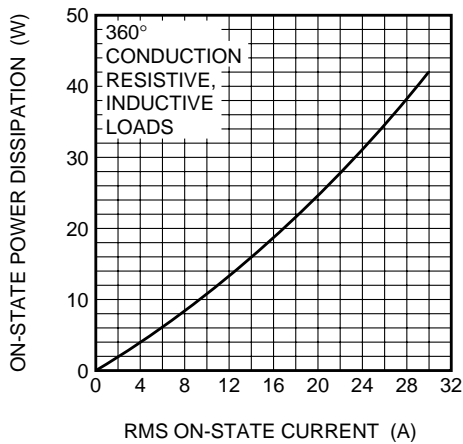

**ALLOWABLE CASE TEMPERATURE  
VS. RMS ON-STATE CURRENT**

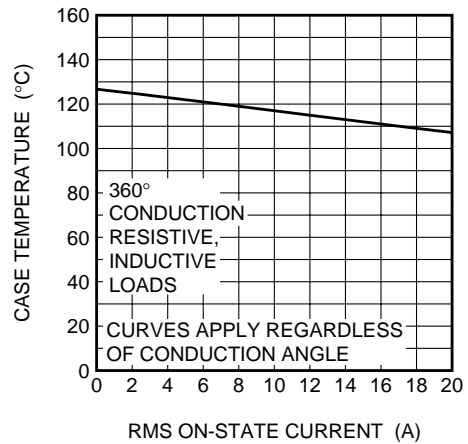

# BCR20AM

MEDIUM POWER USE  
NON-INSULATED TYPE, PLANAR PASSIVATION TYPE

**ALLOWABLE CASE TEMPERATURE VS. RMS ON-STATE CURRENT**

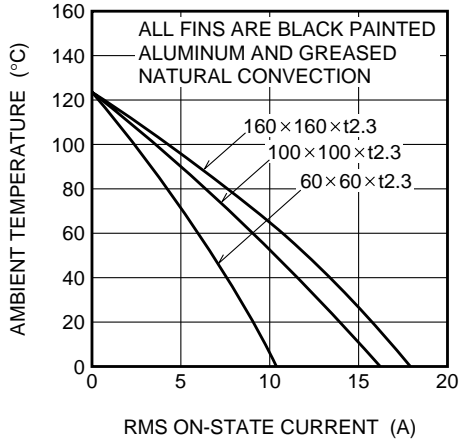

**ALLOWABLE CASE TEMPERATURE VS. RMS ON-STATE CURRENT**

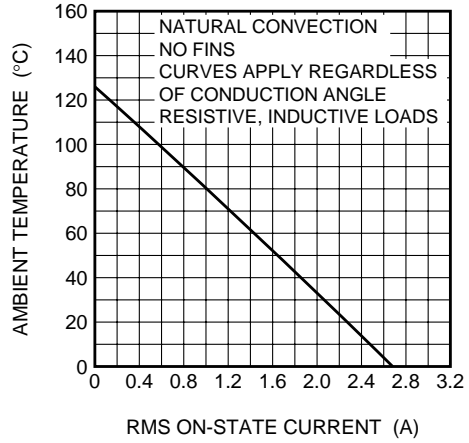

**REPETITIVE PEAK OFF-STATE CURRENT VS. JUNCTION TEMPERATURE**

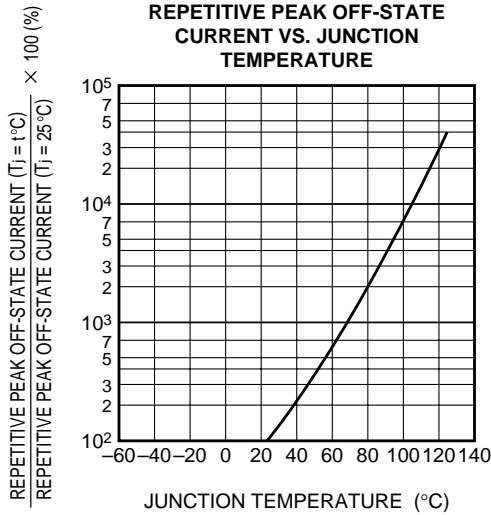

**HOLDING CURRENT VS. JUNCTION TEMPERATURE**

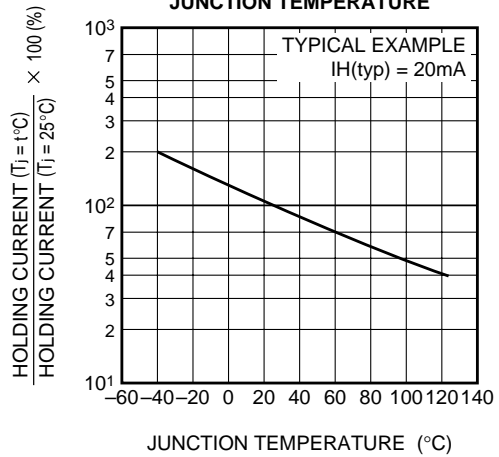

**LATCHING CURRENT VS. JUNCTION TEMPERATURE**

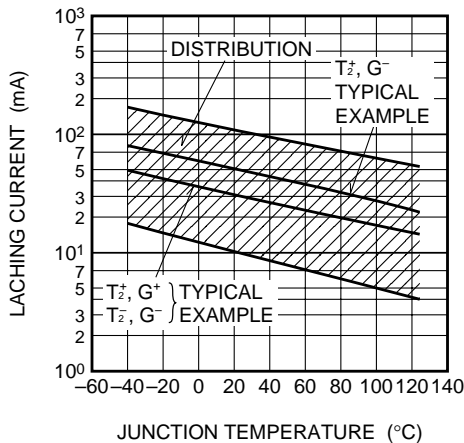

**BREAKOVER VOLTAGE VS. JUNCTION TEMPERATURE**

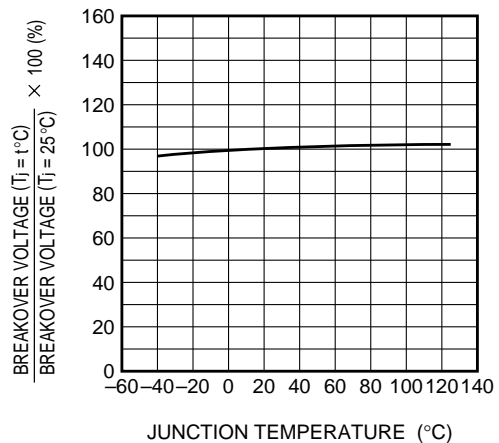

# BCR20AM

MEDIUM POWER USE

NON-INSULATED TYPE, PLANAR PASSIVATION TYPE

**BREAKOVER VOLTAGE VS. RATE OF RISE OF OFF-STATE VOLTAGE**

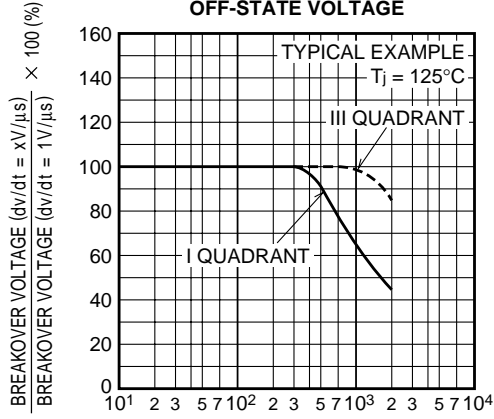

RATE OF RISE OF OFF-STATE VOLTAGE (V/μs)

**COMMUTATION CHARACTERISTICS**

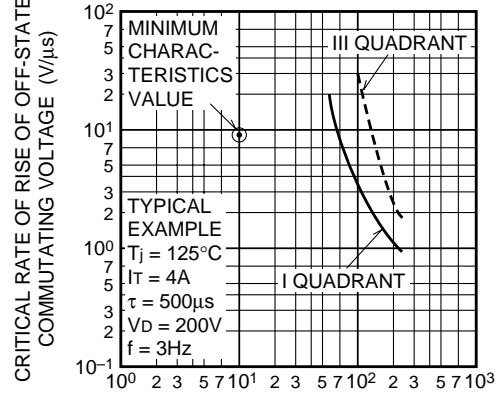

RATE OF DECAY OF ON-STATE COMMUTATING CURRENT (A/ms)

**GATE TRIGGER CURRENT VS. GATE CURRENT PULSE WIDTH**

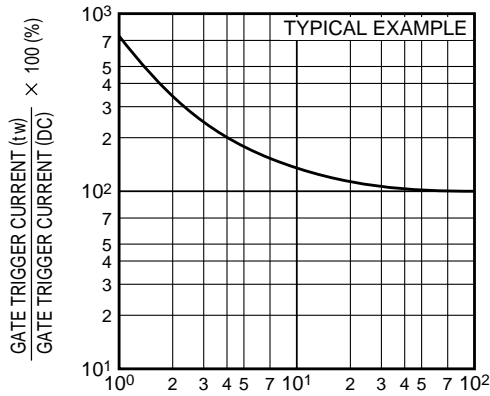

GATE TRIGGER PULSE WIDTH (μs)

**GATE TRIGGER CHARACTERISTICS TEST CIRCUITS**

