

PNP Silicon AF Switching Transistor

BCX 13

- For general AF applications
- High breakdown voltage
- Low collector-emitter saturation voltage
- Complementary type: BCX 12 (NPN)

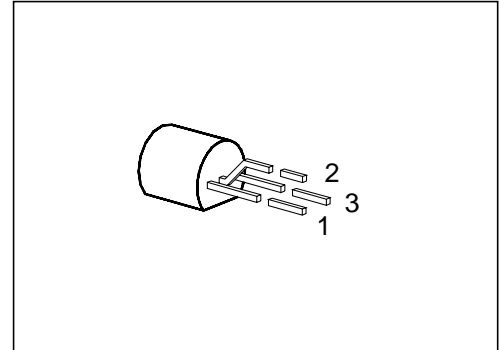

Type	Marking	Ordering Code	Pin Configuration			Package ¹⁾
			1	2	3	
BCX 13	BCX 13	Q62702-C26	C	B	E	TO-92

Maximum Ratings

Parameter	Symbol	Values	Unit
Collector-emitter voltage	V_{CE0}	125	V
Collector-base voltage	V_{CB0}	125	
Emitter-base voltage	V_{EB0}	5	
Collector current	I_C	800	mA
Peak collector current	I_{CM}	1	A
Base current	I_B	100	mA
Peak base current	I_{BM}	200	
Total power dissipation, $T_c = 66\text{ °C}$	P_{tot}	625	mW
Junction temperature	T_j	150	°C
Storage temperature range	T_{stg}	- 65 ... + 150	

Thermal Resistance

Junction - ambient	$R_{th\ JA}$	≤ 200	K/W
Junction - case ²⁾	$R_{th\ JC}$	≤ 135	

¹⁾ For detailed information see chapter Package Outlines.

²⁾ Mounted on Al heat sink 15 mm × 25 mm × 0.5 mm.

Electrical Characteristics

at $T_A = 25\text{ }^\circ\text{C}$, unless otherwise specified.

Parameter	Symbol	Values			Unit
		min.	typ.	max.	

DC characteristics for transistor T1

Collector-emitter breakdown voltage $I_C = 10\text{ mA}$, $I_B = 0$	$V_{(BR)CE0}$	125	–	–	V
Collector-base breakdown voltage $I_C = 100\text{ }\mu\text{A}$, $I_B = 0$	$V_{(BR)CB0}$	125	–	–	
Emitter-base breakdown voltage $I_E = 10\text{ }\mu\text{A}$, $I_C = 0$	$V_{(BR)EBS}$	5	–	–	
Collector-base cutoff current $V_{CB} = 100\text{ V}$, $I_E = 0$ $V_{CB} = 100\text{ V}$, $I_E = 0$, $T_A = 150\text{ }^\circ\text{C}$	I_{CB0}	–	–	100 10	nA μA
Emitter cutoff current $V_{EB} = 4\text{ V}$	I_{EB0}	–	–	100	nA
DC current gain ¹⁾ $I_C = 1\text{ mA}$, $V_{CE} = 1\text{ V}$ $I_C = 10\text{ mA}$, $V_{CE} = 1\text{ V}$ $I_C = 100\text{ mA}$, $V_{CE} = 1\text{ V}$ $I_C = 200\text{ mA}$, $V_{CE} = 1\text{ V}$	h_{FE}	25 50 63 40	– – – –	– – – –	–
Collector-emitter saturation voltage ¹⁾ $I_C = 500\text{ mA}$, $I_B = 50\text{ mA}$	V_{CEsat}	–	–	1.0	V
Base-emitter saturation voltage ¹⁾ $I_C = 500\text{ mA}$, $I_B = 50\text{ mA}$	V_{BEsat}	–	–	1.6	

AC characteristics

Transition frequency $I_C = 20\text{ mA}$, $V_{CE} = 5\text{ V}$, $f = 20\text{ MHz}$	f_T	–	120	–	MHz
Output capacitance $V_{CB} = 10\text{ V}$, $f = 1\text{ MHz}$	C_{obo}	–	12	–	pF

¹⁾ Pulse test: $t \leq 300\text{ }\mu\text{s}$, $D \leq 2\%$.

Total power dissipation $P_{tot} = f(T_A; T_C)$

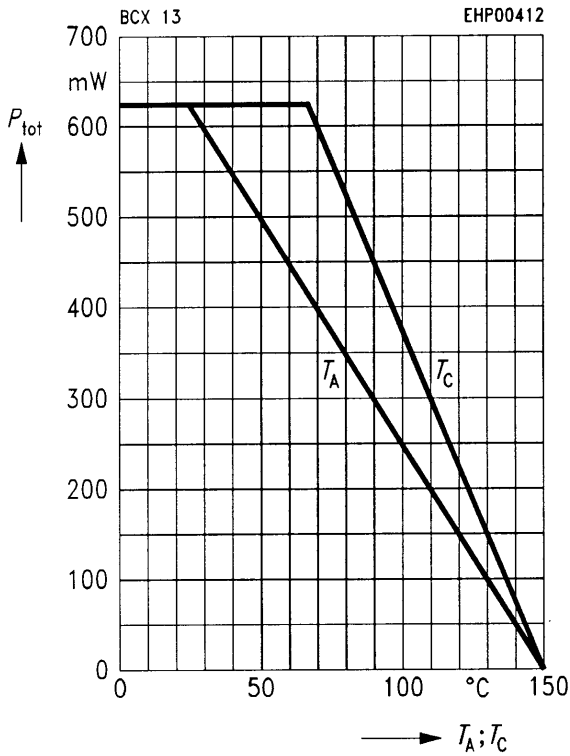

Permissible pulse load $R_{thJA} = f(t_p)$

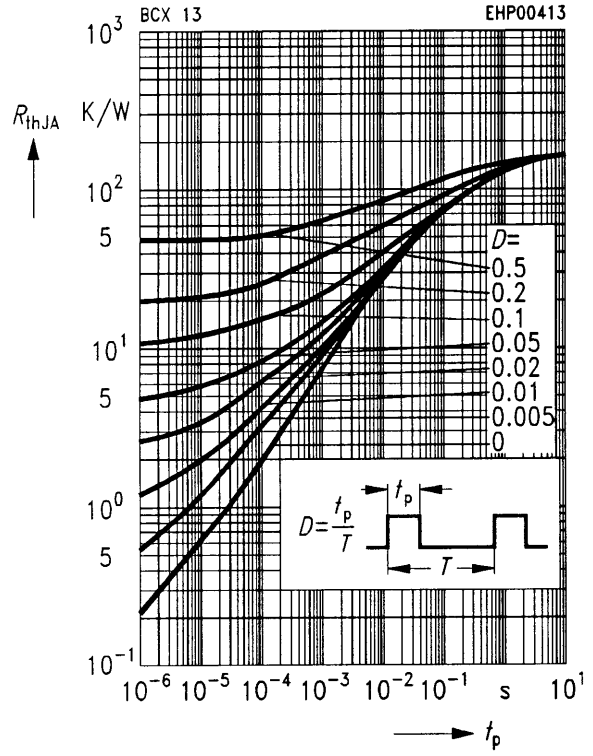

Collector current $I_C = f(V_{BE})$
 $V_{CE} = 1 \text{ V}$

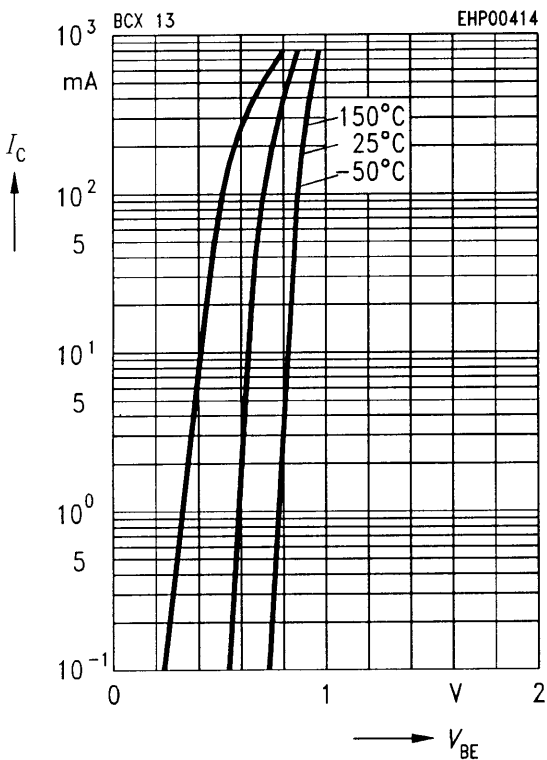

Collector cutoff current $I_{CB0} = f(T_A)$
 $V_{CB} = V_{CBmax}$

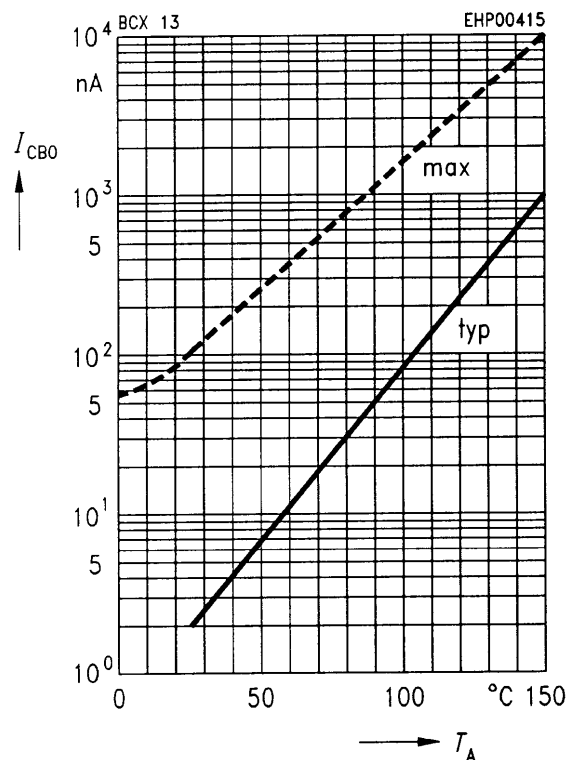

DC current gain $h_{FE} = f(I_C)$

$V_{CE} = 1 \text{ V}$

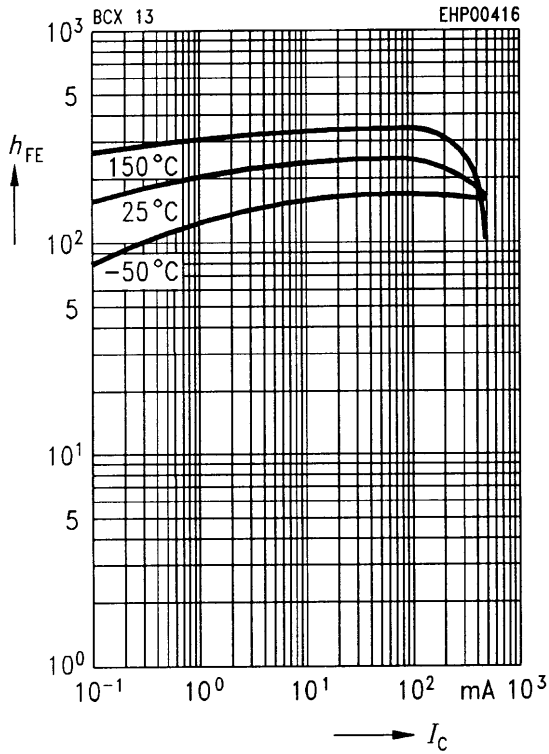

Transition frequency $f_T = f(I_C)$

$f = 20 \text{ MHz}, V_{CE} = 5 \text{ V}, T_A = 25^\circ\text{C}$

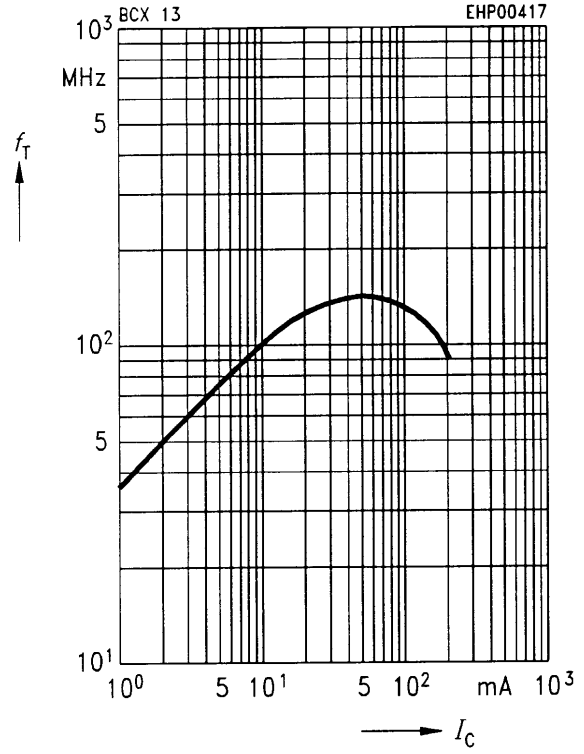

Collector-emitter saturation voltage

$I_C = f(V_{CEsat}), h_{FE} = 10$

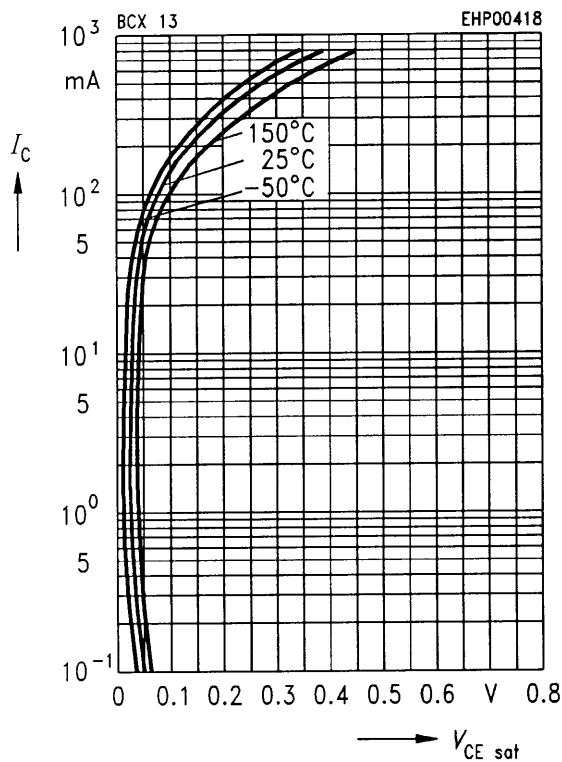

Base-emitter saturation voltage

$I_C = f(V_{BEsat}), h_{FE} = 10$

