

Xinger®

Ultra Low Profile 0805 Balun 50Ω to 200Ω Balanced

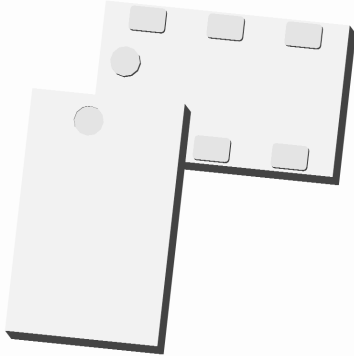

Description

The BD0810J50200AHF is a low profile sub-miniature balanced to unbalanced transformer designed for differential inputs and output locations on next generation wireless chipsets in an easy to use surface mount package covering the GSM frequency. The BD0810J50200AHF is ideal for high volume manufacturing and is higher performance than traditional ceramic and lumped element baluns. The BD0810J50200A00 has an unbalanced port impedance of 50Ω and a 200Ω balanced port impedance. This transformation enables single ended signals to be applied to differential ports on modern semiconductors. The output ports have equal amplitude (-3dB) with 180 degree phase differential. The BD0810J50200AHF is available on tape and reel for pick and place high volume manufacturing.

Detailed Electrical Specifications: Specifications subject to change without notice.

Features:	Parameter	ROOM (25°C)			Unit	
		Min.	Typ.	Max		
<ul style="list-style-type: none"> • 800 – 1000 MHz • 0.7mm Height Profile • 50 Ohm to 2 x 100 Ohm • GSM • Low Insertion Loss • Input to Output DC Isolation • Surface Mountable • Tape & Reel • Non-conductive Surface • RoHS Compliant • Halogen Free 	Frequency	800		1000	MHz	
	Unbalanced Port Impedance		50		Ω	
	Balanced Port Impedance		200		Ω	
	Return Loss	14.5	19		dB	
	Insertion Loss*		0.7	1.0	dB	
	Amplitude Balance		0.6	1.1	dB	
	Phase Balance		5.9	8.0	Degrees	
	CMRR		24.6		dB	
	Power Handling			2	Watts	
	Operating Temperature		-55		+85	°C

* Insertion Loss stated at room temperature (Insertion Loss is approximately 0.1 dB higher at +85 °C)

Outline Drawing

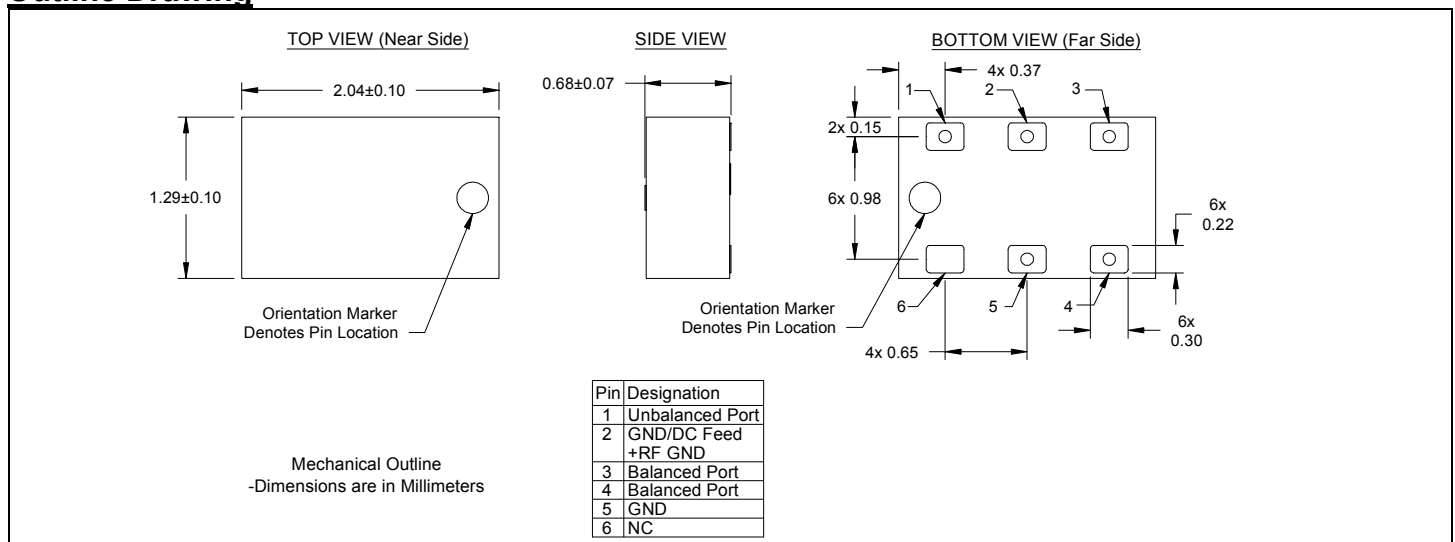

Typical Broadband Performance: 100 MHz. to 4.0 GHz.

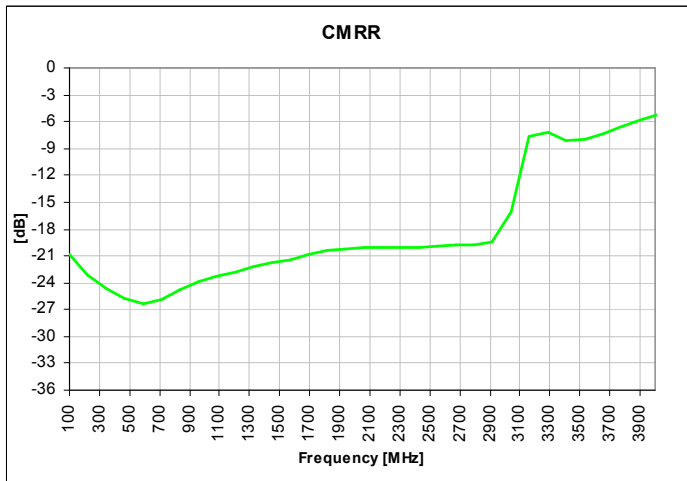
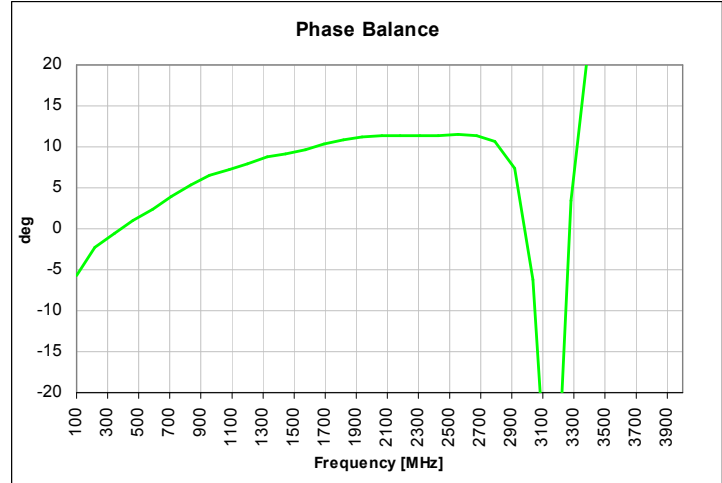
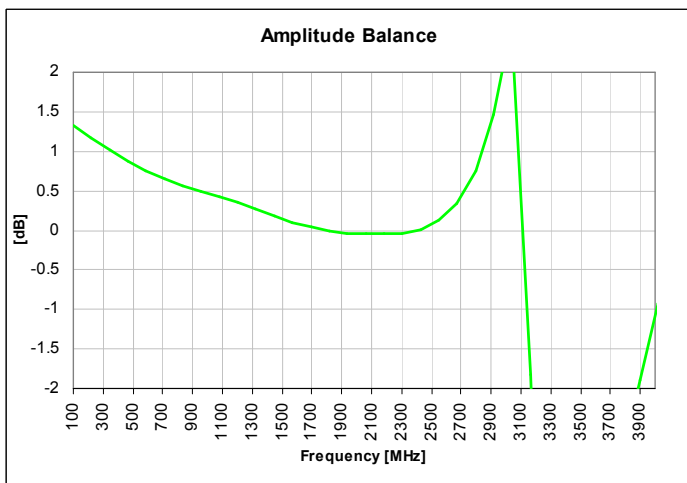
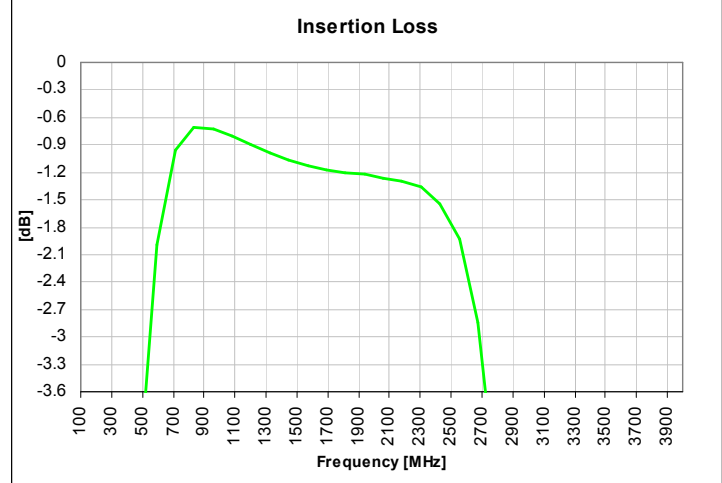
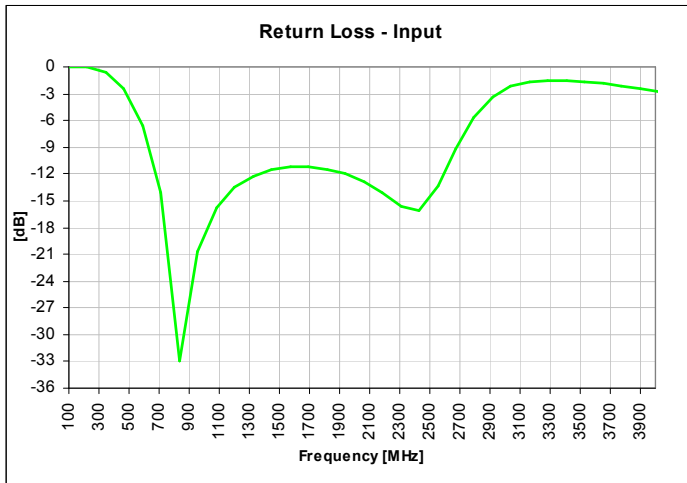

Typical Performance: 600 MHz. to 1200 MHz.

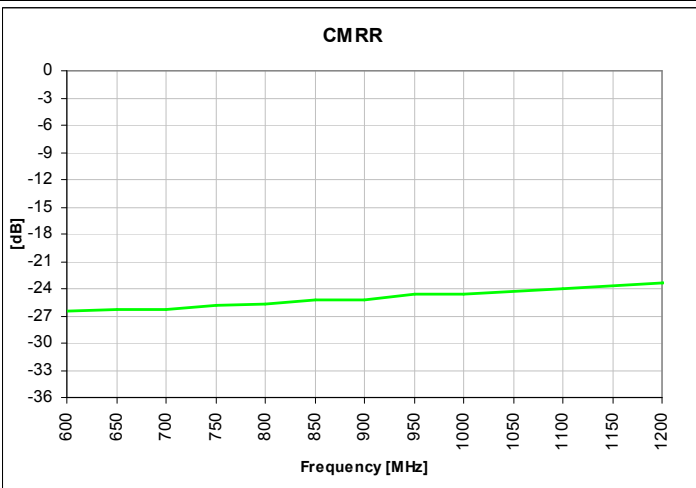
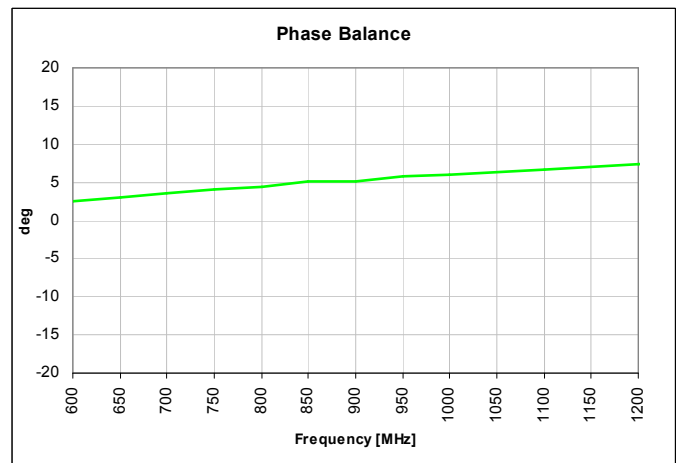
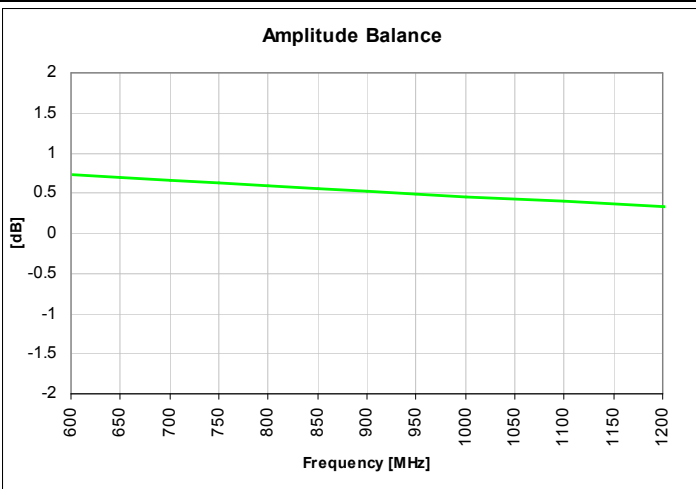
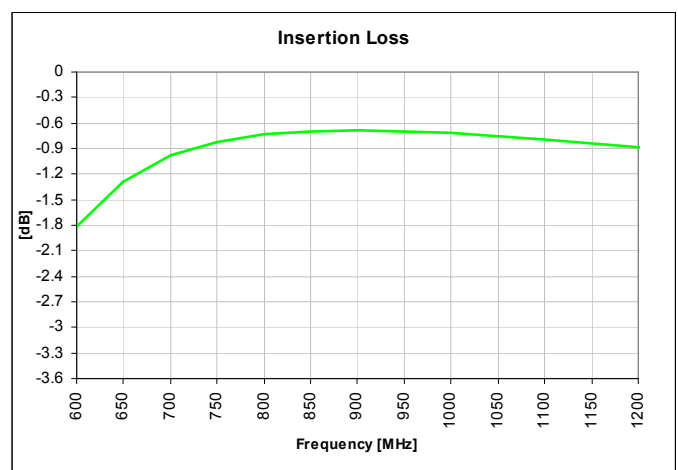
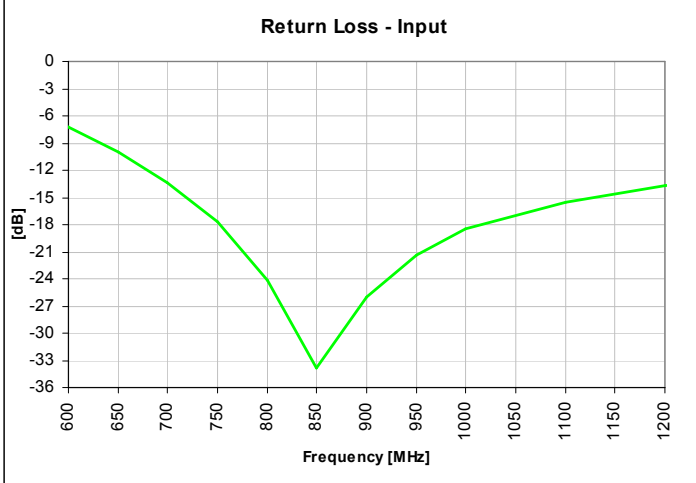

Mounting Configuration:

In order for Xinger surface mount components to work optimally, the proper impedance transmission lines must be used to connect to the RF ports. If this condition is not satisfied, insertion loss, Isolation and VSWR may not meet published specifications.

All of the Xinger components are constructed from organic PTFE based composites which possess excellent electrical and mechanical stability. Xinger components are compliant to a variety of ROHS and Green standards and ready for Pb-free soldering processes. Pads are Gold plated with a Nickel barrier.

An example of the PCB footprint used in the testing of these parts is shown below. An example of a DC-biased footprint is also shown below. In specific designs, the transmission line widths need to be adjusted to the unique dielectric coefficients and thicknesses as well as varying pick and place equipment tolerances.

No Bias Footprint

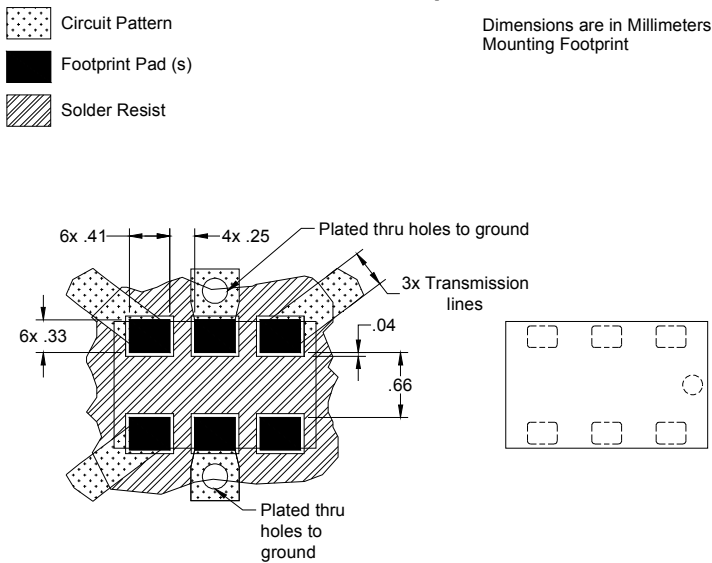

DC Bias Footprint

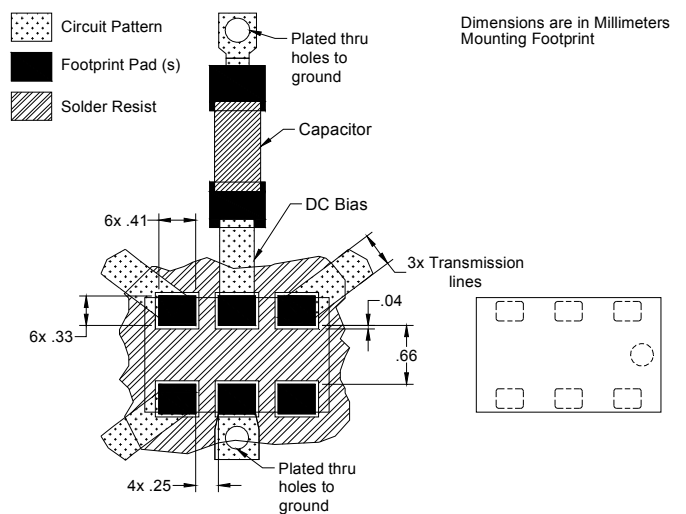

Packaging and Ordering Information

Parts are available in reel and are packaged per EIA 481-2. Parts are oriented in tape and reel as shown below. Minimum order quantities are 4000 per reel. See Model Numbers below for further ordering information.

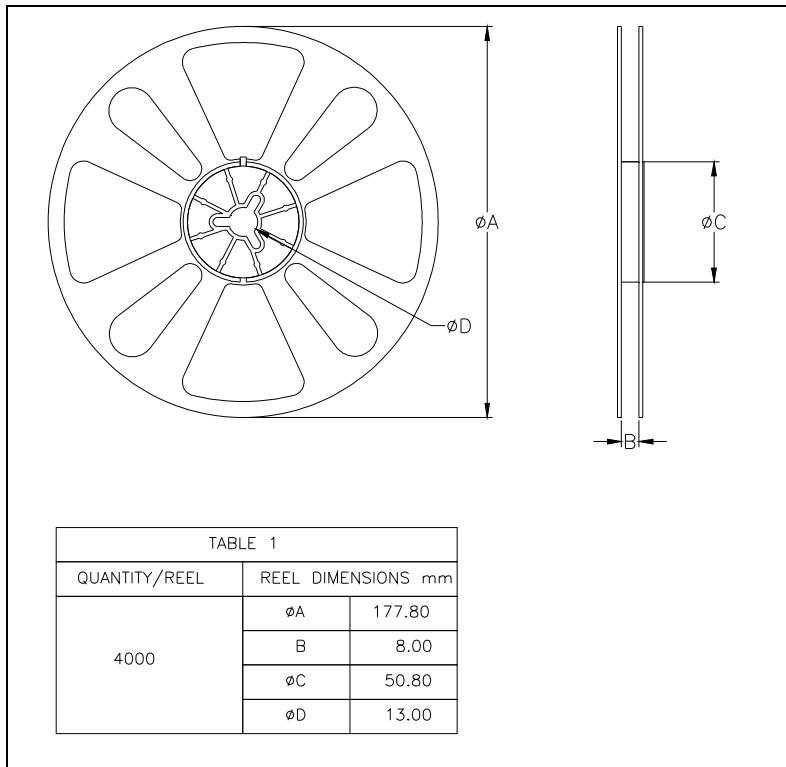
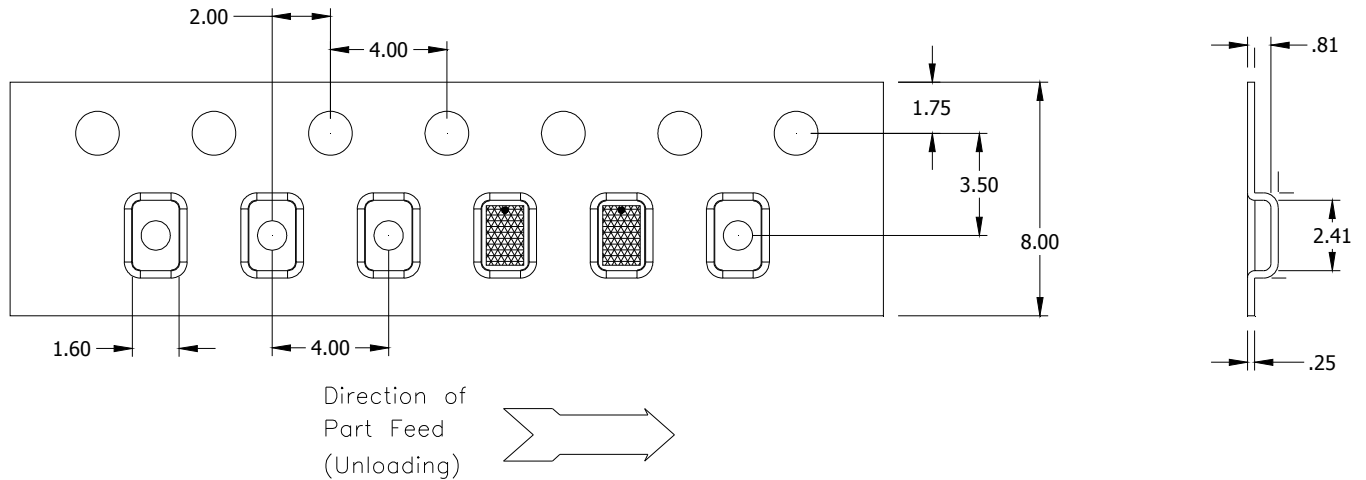

Mouser Electronics

Authorized Distributor

Click to View Pricing, Inventory, Delivery & Lifecycle Information:

[Anaren:](#)

[BD0810J50200AHF](#)