

High-performance Regulator IC Series for PCs

Ultra Low Dropout

Linear Regulators for PC Chipsets

BD3508EKN

- Description

The BD3508EKN ultra low-dropout linear chipset regulator operates from a very low input supply, and offers ideal performance in low input voltage to low output voltage applications. It incorporates a built-in N-MOSFET power transistor to minimize the input-to-output voltage differential to the ON resistance ($R_{ON}=65m\Omega$) level. By lowering the dropout voltage in this way, the regulator realizes high current output ($I_{omax}=3.0A$) with reduced conversion loss, and thereby obviates the switching regulator and its power transistor, choke coil, and rectifier diode. Thus, the BD3508EKN is designed to enable significant package profile downsizing and cost reduction. An external resistor allows the entire range of output voltage configurations between 0.65 and 2.7V, while the NRCS (soft start) function enables a controlled output voltage ramp-up, which can be programmed to whatever power supply sequence is required.

- Features

- 1) Internal high-precision reference voltage circuit($0.65V\pm 1\%$)
- 2) Built-in VCC under voltage lock out circuit ($VCC=3.80V$)
- 3) NRCS (soft start) function reduces the magnitude of in-rush current
- 4) Internal Nch MOSFET driver offers low ON resistance ($65m\Omega$ typ)
- 5) Built-in current limit circuit($3.0A$ min)
- 6) Built-in thermal shutdown (TSD) circuit
- 7) Variable output ($0.65\sim 2.7V$)
- 8) Incorporates high-power HQFN20V package: $4.2\times 4.2\times 0.9(mm)$

- Applications

Notebook computers, Desktop computers, LCD-TV, DVD, Digital appliances

- Model Lineup

●Absolute Maximum Ratings

◎BD3508EKN

○Absolute Maximum Ratings(Ta=100°C)

PARAMETER	SYMBOL	RATING	UNIT
Input Voltage 1	VCC	6.0 * ¹	V
Input Voltage 2	VIN	6.0 * ¹	V
Enable Input Voltage	Ven	6.0	V
Power Dissipation 1	Pd1	0.5 * ²	W
Power Dissipation 2	Pd2	0.75 * ³	W
Power Dissipation 3	Pd3	1.75 * ⁴	W
Power Dissipation 4	Pd4	2.0 * ⁵	W
Operating Temperature Range	Topr	-10~+100	°C
Storage Temperature Range	Tstg	-55~+125	°C
Maximum Junction Temperature	Tjmax	+150	°C

*¹ Should not exceed Pd.

*² Reduced by 4mW/°C for each increase in Ta ≥ 25°C (no heat sink)

*³ Reduced by 6mW/°C for each increase in Ta ≥ 25°C (when mounted on a 70mm×70mm×1.6mm glass-epoxy board, with no copper foil on the bottom surface)

*⁴ Reduced by 14mW/°C for each increase in Ta ≥ 25°C (when mounted on a 70mm×70mm×1.6mm glass-epoxy board, with 60mm X 60 mm copper foil on the bottom surface...1-layer)

*⁵ Reduced by 16mW/°C for each increase in Ta ≥ 25°C (when mounted on a 70mm×70mm×1.6mm glass-epoxy board, with 60mm X 60 mm copper foil on the bottom surface...2-layer)

●Operating Conditions

○Operating Voltage(Ta=25°C)

PARAMETER	SYMBOL	MIN.	MAX.	UNIT
Input Voltage 1	VCC	4.3	5.5	V
Input Voltage 2	VIN	0.75	VCC-1 * ⁶	V
Output Voltage Setting Range	Vo	VFB	2.7	V
Enable Input Voltage	Ven	-0.3	5.5	V
NRCS Capacity	CNRCS	0.001	1	uF

*⁶ VCC and VIN do not have to be implemented in the order listed.

★This product is not designed for use in radioactive environments.

●Electrical Characteristics (Unless otherwise specified, Ta=25°C VCC=5V Ven=3V VIN=1.8V R1=3.9KΩ R2=3.3KΩ)

Parameter	Symbol	Limit			Unit	Condition
		Min.	Typ.	Max.		
Bias Current	ICC	-	0.7	1.4	mA	
VCC Shutdown Mode Current	IST	-	0	10	uA	Ven=0V
Output Voltage	VOUT	-	1.200	-	V	
Maximum Output Current	Io	3.0	-	-	A	
Output Short Circuit Current	Iost	3.0	-	-	A	Vo=0V
Output Voltage Temperature Coefficient	Tcvo	-	0.01	-	%/°C	
Feedback Voltage 1	VFB1	0.643	0.650	0.657	V	
Feedback Voltage 2	VFB2	0.630	0.650	0.670	V	Io=0 to 3A Ta=-10 to 100°C *7
Line Regulation 1	Reg.I1	-	0.1	0.5	%/V	VCC=4.3V to 5.5V
Line Regulation 2	Reg.I2	-	0.1	0.5	%/V	VIN=1.2V to 3.3V
Load Regulation	Reg.L	-	0.5	10	mV	Io=0 to 3A
Minimum Input-Output Voltage Differential	dVo	-	65	100	mV	Io=1A, VIN=1.2V Ta=-10 to 100°C *7
Standby Discharge Current	I _{den}	1	-	-	mA	Ven=0V, Vo=1V
[ENABLE]						
Enable Pin Input Voltage High	Enhi	2	-	-	V	
Enable Pin Input Voltage Low	Enlow	-0.2	-	0.8	V	
Enable Input Bias Current	I _{en}	-	7	10	uA	Ven=3V
[FEEDBACK]						
Feedback Pin Bias Current	IFB	-100	0	100	nA	
[NRCS]						
NRCS Charge Current	I _{nrcs}	14	20	26	uA	V _{nrcs} =0.5V
NRCS Standby Voltage	VSTB	-	0	50	mV	Ven=0V
[UVLO]						
VCC Under voltage Lock out Threshold Voltage	V _{ccUVLO}	3.5	3.8	4.1	V	VCC:Sweep-up
VCC Under voltage Lock out Hysteresis Voltage	V _{ccHys}	100	160	220	mV	VCC:Sweep-down
[AMP]						
Gate Source Current	I _{GSO}	-	1.6	-	mA	V _{FB} =0, V _{GATE} =2.5V
Gate Sink Current	I _{GSI}	-	4.7	-	mA	V _{FB} =VCC, V _{GATE} =2.5V

*7 Design targets

• Reference Data

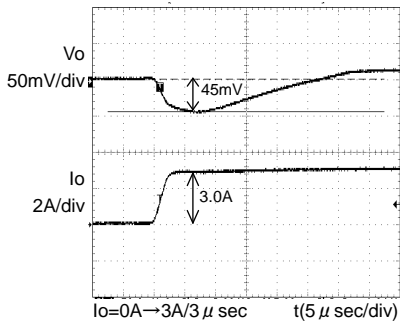

Fig.1 Transient response (0→3A)
Co=150 μ F × 2

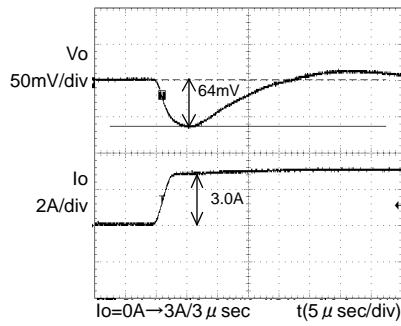

Fig.2 Transient response (0→3A)
Co=150 μ F

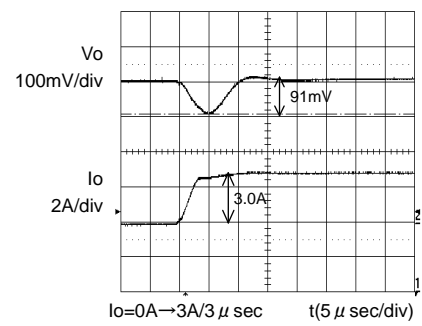

Fig.3 Transient response (0→3A)
Co=47 μ F

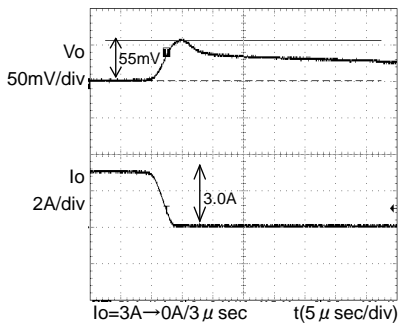

Fig.4 Transient response (3→0A)
Co=150 μ F × 2

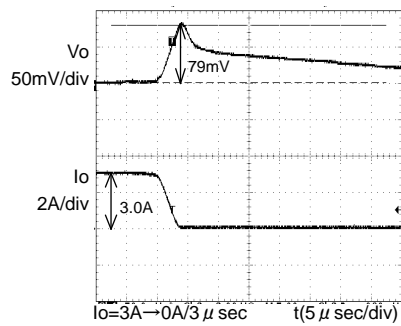

Fig.5 Transient response (3→0A)
Co=150 μ F

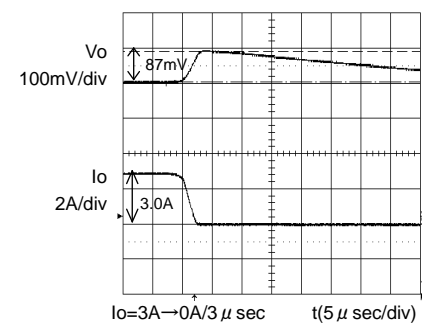

Fig.6 Transient response (3→0A)
Co=47 μ F

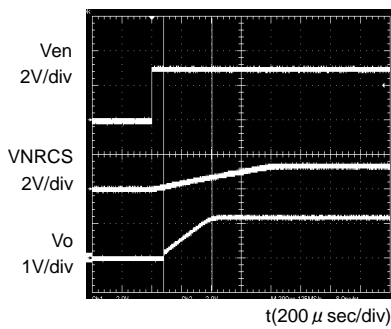

Fig.7 Waveform at output start

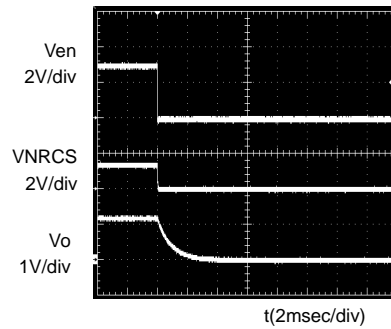

Fig.8 Waveform at output OFF

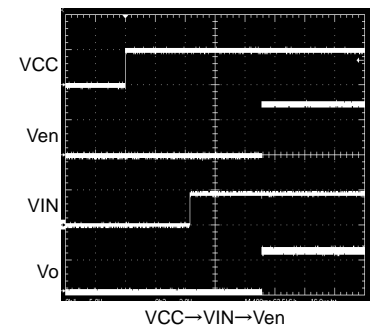

Fig.9 Input sequence

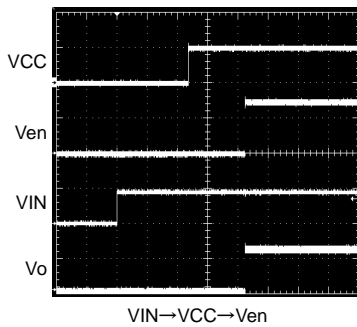

Fig.10 Input sequence

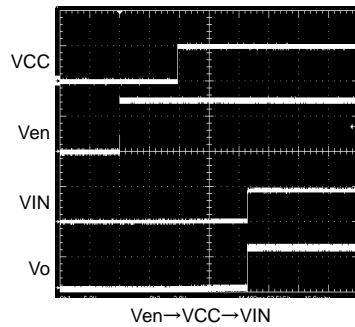

Fig.11 Input sequence

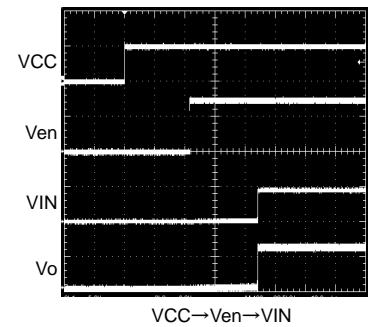

Fig.12 Input sequence

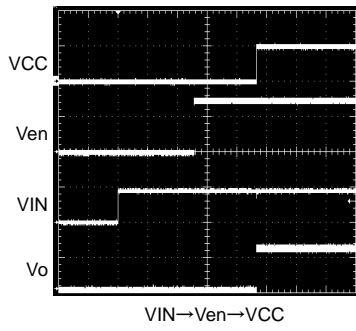

Fig.13 Input sequence

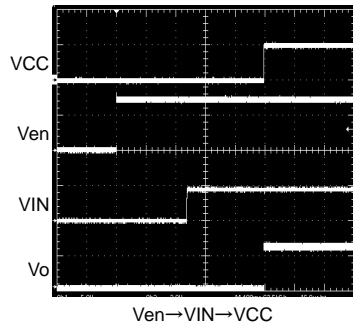

Fig.14 Input sequence

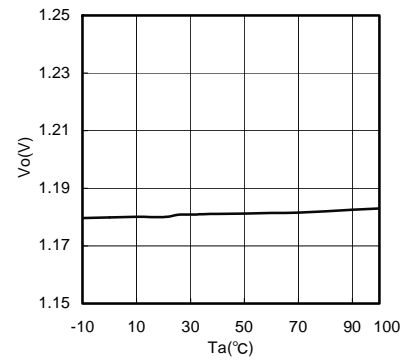

Fig.15 Ta-Vo (Io=0mA)

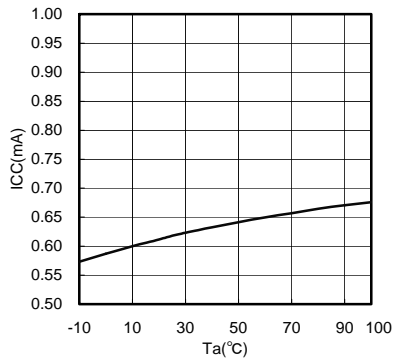

Fig.16 Ta-ICC

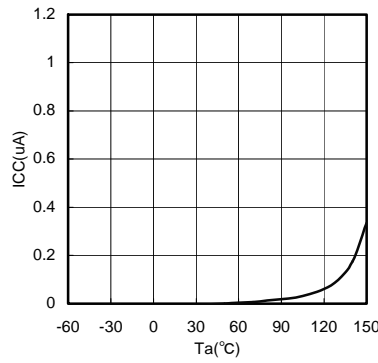

Fig.17 Ta-ISTB

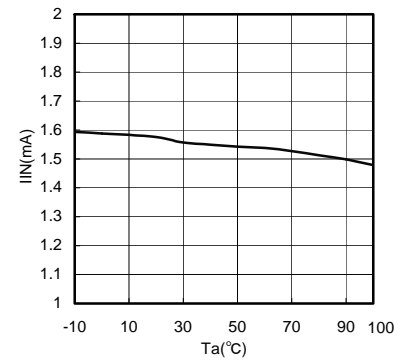

Fig.18 Ta-IIN

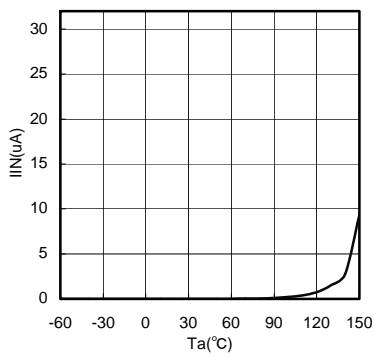

Fig.19 Ta-IINSTB

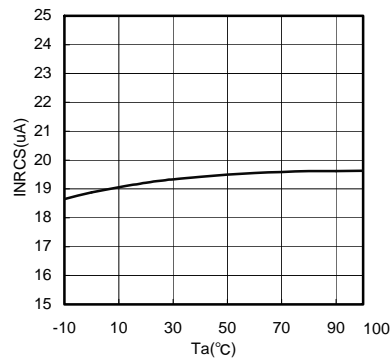

Fig.20 Ta-INRCS

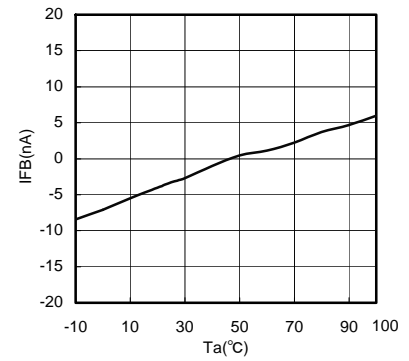

Fig.21 Ta-IFB

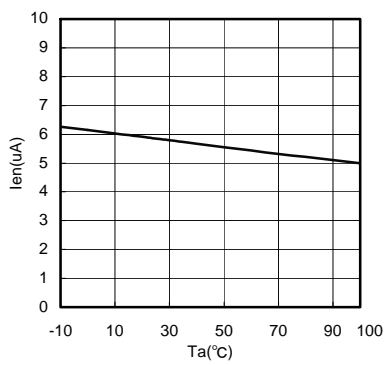

Fig.22 Ta-Ien

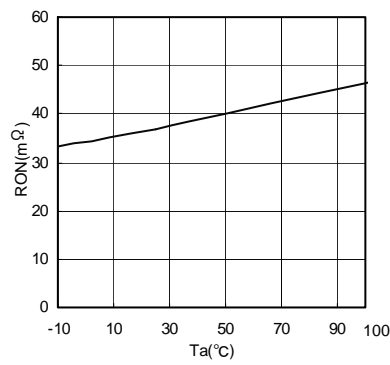

Fig.23 Ta-RON
(VCC=5V/Vo=1.2V)

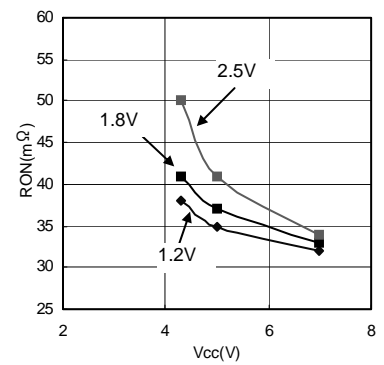

Fig.24 VCC-RON

- Operation of Each Block

- AMP

This is an error amp that functions by comparing the reference voltage (0.65V) with V_o to drive the output Nch FET ($R_{on}=65m\Omega$). Frequency optimization helps to realize rapid transit response, and to support the use of functional polymer output capacitors. AMP input voltage ranges from GND to 2.7V, while the AMP output ranges from GND to VCC. When EN is OFF, or when UVLO is active, output goes LOW and the output NchFET switches OFF.

- EN

The EN block controls the regulator ON/OFF pin by means of the logic input pin. In OFF position, circuit voltage is maintained at $0\mu A$, thus minimizing current consumption at standby. The FET is switched ON to enable discharge of the NRCS pin V_o , thereby draining the excess charge and preventing the load IC from malfunctioning. Since no electrical connection is required (such as between the VCC pin and the ESD prevention Di), module operation is independent of the input sequence.

- UVLO

To prevent malfunctions that can occur when there is a momentary decrease in VCC supply voltage, the UVLO circuit switches output OFF, and, like the EN block, discharges the NRCS V_o . Once the UVLO threshold voltage (TYP3.80V) is exceeded, the power-on reset is triggered and output begins.

- CURRENT LIMIT

With output ON, the current limit function monitors internal IC output current against the parameter value (3.0A). When current exceeds this level, the current limit module lowers the output current to protect the load IC. When the overcurrent state is eliminated, output voltage is restored at the parameter value.

- NRCS

The soft start function is realized by connecting an NRCS pin external capacitor to the target ground. Output ramp-up can be set for any period up to the time the NRCS pin reaches VFB (0.65V). During startup, the NRCS pin serves as the $20\mu A$ (TYP) constant current source and charges the externally connected capacitor.

- TSD (Thermal Shut Down)

The shutdown (TSD) circuit automatically switches output OFF when the chip temperature gets too high, thus serving to protect the IC against "thermal runaway" and heat damage. Because the TSD circuit is provided to shut down the IC in the presence of extreme heat, in order to avoid potential problems with the TSD, it is crucial that the T_j (max) parameter not be exceeded in the thermal design.

- VIN

The VIN line is the major current supply line, and is connected to the output NchFET drain. Since no electrical connection (such as between the VCC pin and an ESD protective Di) is necessary, VIN operates independent of the input sequence. However, since there is an output NchFET body Di between VIN and V_o , a VIN- V_o electric (Di) connection is present. Note, therefore, that when output is switched ON or OFF, reverse current may flow to the VIN from V_o .

●Timing Chart
EN ON/OFF

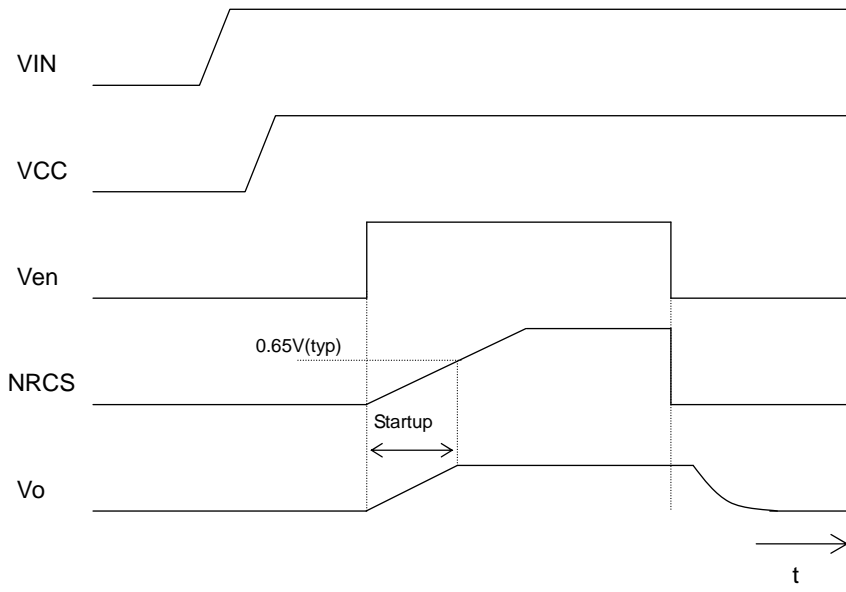

VCC ON/OFF

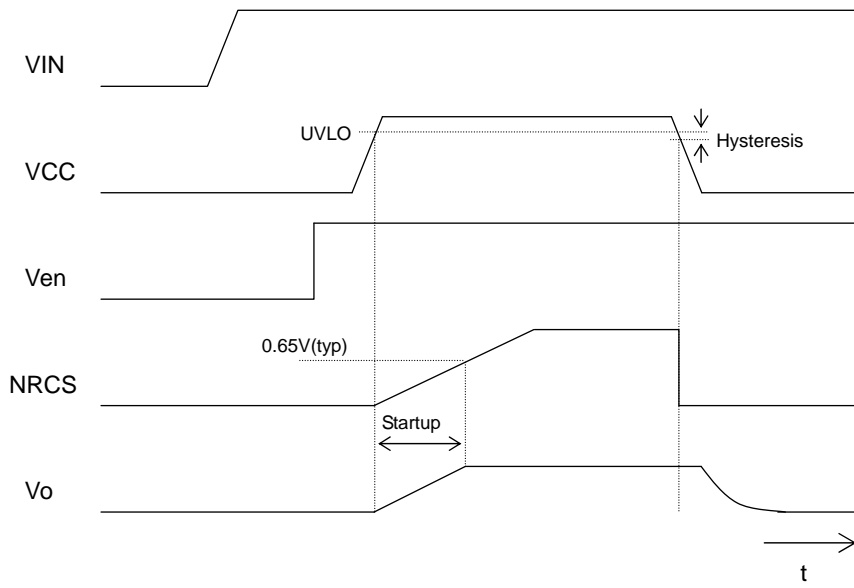

● Evaluation Board

■ BD3508EKN Evaluation Board Schematic

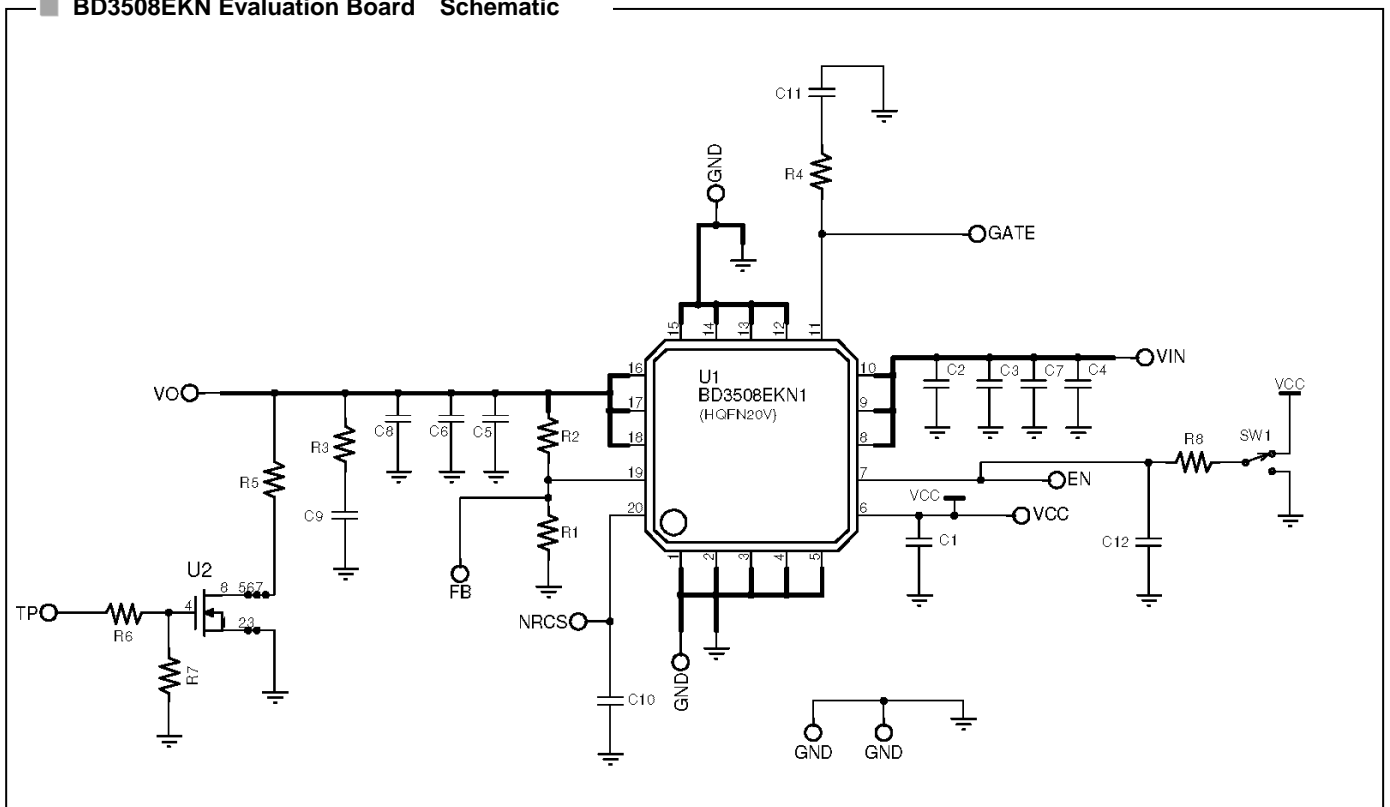

■ BD3508EKN Evaluation Board Standard Component List

Component	Rating	Manufacturer	Product Name
U1	-	ROHM	BD3508EKN
C1	1uF	ROHM	MCH184CN105K
C10	0.01uF	ROHM	MCH185CN103K
R8	0Ω	-	Jumper

Component	Rating	Manufacturer	Product Name
C5	47uF	ROHM	MCH318CN476K
C4	10uF	ROHM	MCH218CN106K
R1	3.9k	ROHM	MCR03EZPF3301
R2	3.3k	ROHM	MCR03EZPF3901

■ BD3508EKN Evaluation Board Layout

Silkscreen

TOP Layer

Bottom Layer

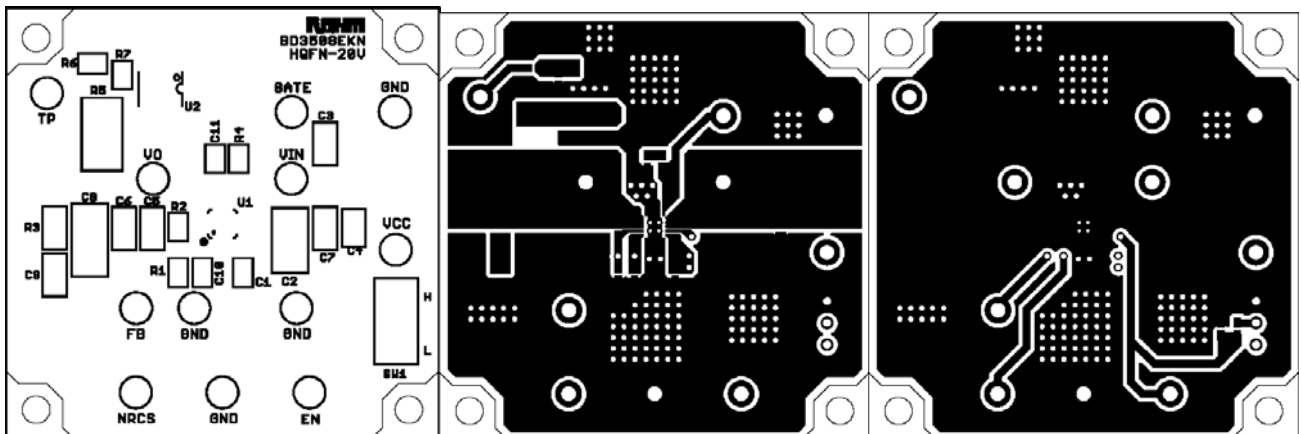

• Recommended Circuit Example

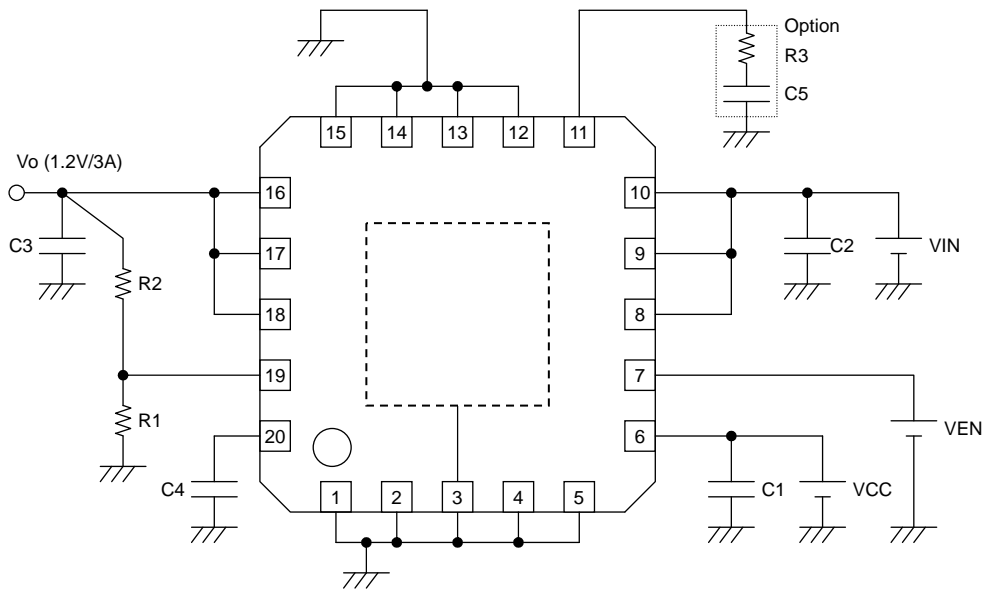

Component	Recommended Value	Programming Notes and Precautions
R1/R2	3.9k/3.3k	IC output voltage can be set with a configuration formula using the values for the internal reference output voltage (V_{FB}) and the output voltage resistors (R1, R2). Select resistance values that will avoid the impact of the V_{FB} current ($\pm 100nA$). The recommended total resistance value is 10K Ω .
C3	47 μF	To assure output voltage stability, please be certain the Vo1, Vo2, and Vo3 pins and the GND pins are connected. Output capacitors play a role in loop gain phase compensation and in mitigating output fluctuation during rapid changes in load level. Insufficient capacitance may cause oscillation, while high equivalent series resistance (ESR) will exacerbate output voltage fluctuation under rapid load change conditions. While a 47 μF ceramic capacitor is recommended, actual stability is highly dependent on temperature and load conditions. Also, note that connecting different types of capacitors in series may result in insufficient total phase compensation, thus causing oscillation. In light of this information, please confirm operation across a variety of temperature and load conditions.
C1	1 μF	Input capacitors reduce the output impedance of the voltage supply source connected to the (VCC) input pins. If the impedance of this power supply were to increase, input voltage (VCC) could become unstable, leading to oscillation or lowered ripple rejection function. While a low-ESR 1 μF capacitor with minimal susceptibility to temperature is recommended, stability is highly dependent on the input power supply characteristics and the substrate wiring pattern. In light of this information, please confirm operation across a variety of temperature and load conditions.
C2	10 μF	Input capacitors reduce the output impedance of the voltage supply source connected to the (VCC) input pins. If the impedance of this power supply were to increase, input voltage (VCC) could become unstable, leading to oscillation or lowered ripple rejection function. While a low-ESR 10 μF capacitor with minimal susceptibility to temperature is recommended, stability is highly dependent on the input power supply characteristics and the substrate wiring pattern. In light of this information, please confirm operation across a variety of temperature and load conditions.
C4	0.01 μF	The Non Rush Current on Startup (NRCS) function is built into the IC to prevent rush current from going through the load (VIN to Vo) and impacting output capacitors at power supply start-up. Constant current comes from the NRCS pin when EN is HIGH or the UVLO function is deactivated. The temporary reference voltage is proportionate to time, due to the current charge of the NRCS pin capacitor, and output voltage start-up is proportionate to this reference voltage. Capacitors with low susceptibility to temperature are recommended, in order to assure a stable soft-start time.
R3/C5	-	This component is employed when the C3 capacitor causes, or may cause, oscillation. It provides more precise internal phase correction.

• Heat Loss

Thermal design should allow operation within the following conditions. Note that the temperatures listed are the allowed temperature limits, and thermal design should allow sufficient margin from the limits.

1. Ambient temperature T_a can be no higher than 100 °C.
2. Chip junction temperature (T_j) can be no higher than 150°C.

Chip junction temperature can be determined as follows:

- ① Calculation based on ambient temperature (T_a)

$$T_j = T_a + \theta_{j-a} \times W$$

<Reference values>

- θ_{j-a} :HQFN20V 250.0°C/W Bare (unmounted) IC
 166.7°C/W 1-layer substrate (top layer copper foil less than 3%)
 71.4°C/W 1-layer substrate (bottom layer surface copper foil area 60×60mm²)
 62.5°C/W 2-layer substrate (top layer copper foil area 60×60mm²)
 Substrate size: 70×70×1.6mm³ (substrate with thermal via)

It is recommended to layout the VIA for heat radiation in the GND pattern of reverse (of IC) when there is the GND pattern in the inner layer (in using multilayer substrate). This package is so small (size: 4.2mm×4.2mm) that it is not available to layout the VIA in the bottom of IC. Spreading the pattern and being increased the number of VIA like the figure below). enable to get the superior heat radiation characteristic. (This figure is the image. It is recommended that the VIA size and the number is designed suitable for the actual situation.).

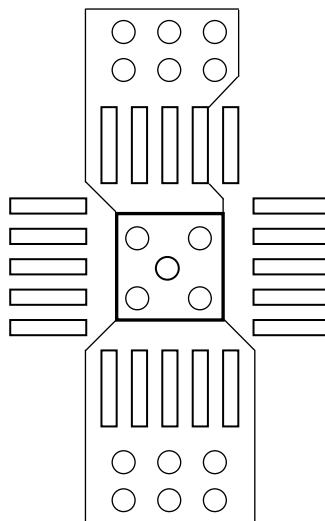

Most of the heat loss that occurs in the BD3508EKN is generated from the output Nch FET. Power loss is determined by the total V_{IN} - V_o voltage and output current. Be sure to confirm the system input and output voltage and the output current conditions in relation to the heat dissipation characteristics of the V_{IN} and V_o in the design. Bearing in mind that heat dissipation may vary substantially depending on the substrate employed (due to the power package incorporated in the BD3508EKN) make certain to factor conditions such as substrate size into the thermal design.

$$\text{Power consumption (W)} = \{ \text{Input voltage (} V_{IN} \text{)- output voltage (} V_o \text{)} \} \times I_o \text{ (Ave)}$$

Example) $V_{IN}=1.5V$, $V_o=1.2V$, $I_o(Ave) = 3A$

$$\text{Power consumption (W)} = \{ 1.5(V)-1.2(V) \} \times 3.0(A)$$

$$= 0.9(W)$$

• Input-Output Equivalent Circuit Diagram

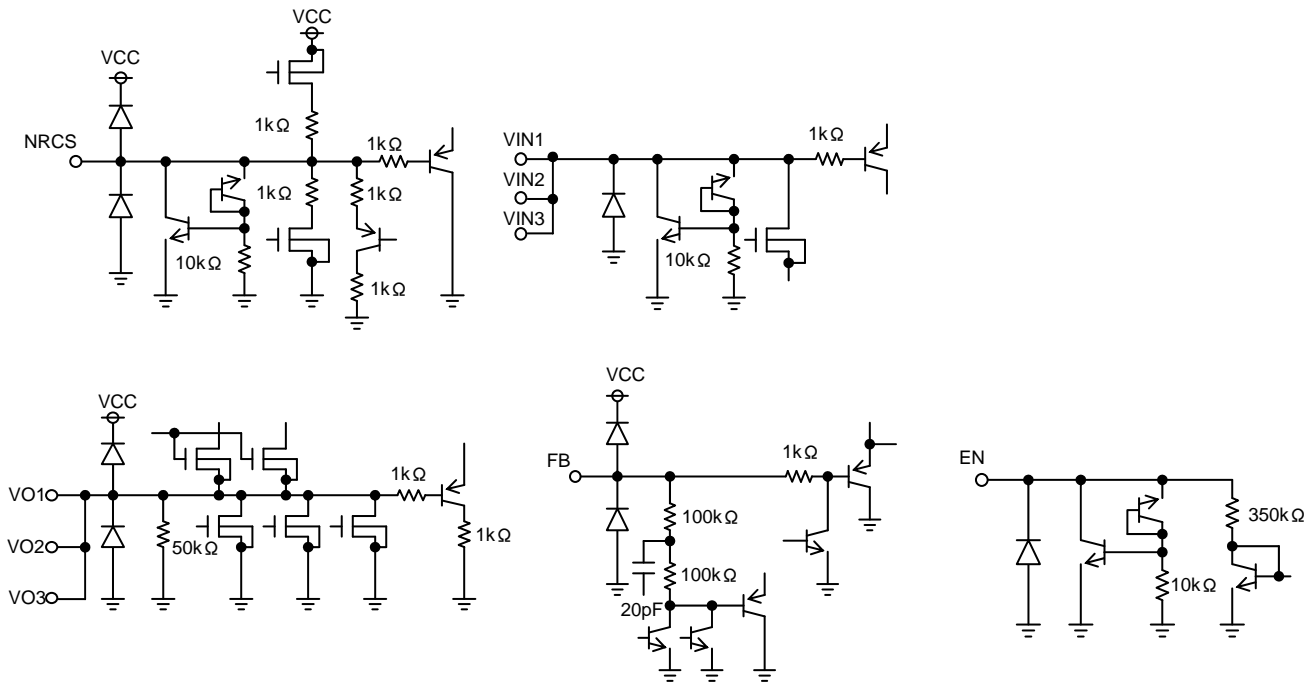

• Reference landing pattern

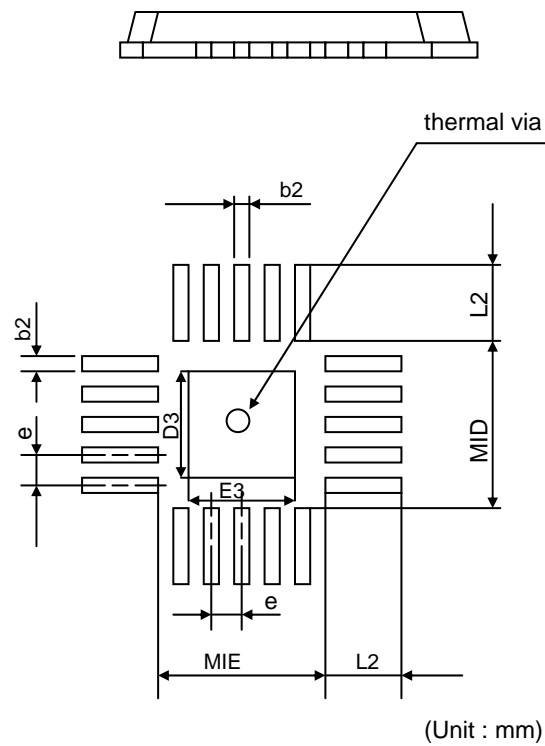

Lead pitch	landing pitch	landing length	landing pitch
e	MIE	≥ 12	$b2$
0.50	2.60	1.10	0.25
central pad length	central pad pitch	thermal via	
$D3$	$E3$	Diameter	
1.60	1.60	$\Phi 0.30$	

*It is recommended to design suitable for the actual application.

●Operation Notes

1. Absolute maximum ratings

An excess in the absolute maximum ratings, such as supply voltage, temperature range of operating conditions, etc., can break down the devices, thus making impossible to identify breaking mode, such as a short circuit or an open circuit. If any over rated values will expect to exceed the absolute maximum ratings, consider adding circuit protection devices, such as fuses.

2. Connecting the power supply connector backward

Connecting of the power supply in reverse polarity can damage IC. Take precautions when connecting the power supply lines. An external direction diode can be added.

3. Output pin

In the event that load containing a large inductance component is connected to the output terminal, and generation of back-EMF at the start-up and when output is turned OFF is assumed, it is requested to insert a protection diode.

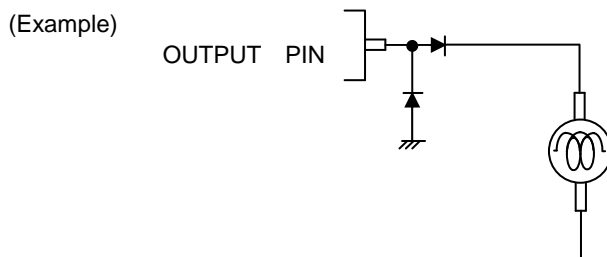

4. GND voltage

The potential of GND pin must be minimum potential in all operating conditions.

5. Thermal design

Use a thermal design that allows for a sufficient margin in light of the power dissipation (Pd) in actual operating conditions.

6. Inter-pin shorts and mounting errors

Use caution when positioning the IC for mounting on printed circuit boards. The IC may be damaged if there is any connection error or if pins are shorted together.

7. Actions in strong electromagnetic field

Use caution when using the IC in the presence of a strong electromagnetic field as doing so may cause the IC to malfunction.

8. ASO

When using the IC, set the output transistor so that it does not exceed absolute maximum ratings or ASO.

9. Thermal shutdown circuit

The IC incorporates a built-in thermal shutdown circuit (TSD circuit). The thermal shutdown circuit (TSD circuit) is designed only to shut the IC off to prevent thermal runaway. It is not designed to protect the IC or guarantee its operation. Do not continue to use the IC after operating this circuit or use the IC in an environment where the operation of this circuit is assumed.

	TSD on temperature [°C] (typ.)	Hysteresis temperature [°C] (typ.)
BD3508EKN	175	15

10. Testing on application boards

When testing the IC on an application board, connecting a capacitor to a pin with low impedance subjects the IC to stress. Always discharge capacitors after each process or step. Always turn the IC's power supply off before connecting it to or removing it from a jig or fixture during the inspection process. Ground the IC during assembly steps as an antistatic measure. Use similar precaution when transporting or storing the IC.

11. Regarding input pin of the IC

This monolithic IC contains P+ isolation and P substrate layers between adjacent elements in order to keep them isolated. P-N junctions are formed at the intersection of these P layers with the N layers of other elements, creating a parasitic diode or transistor. For example, the relation between each potential is as follows:

When $GND > Pin A$ and $GND > Pin B$, the P-N junction operates as a parasitic diode.

When $GND > Pin B$, the P-N junction operates as a parasitic transistor.

Parasitic diodes can occur inevitable in the structure of the IC. The operation of parasitic diodes can result in mutual interference among circuits, operational faults, or physical damage. Accordingly, methods by which parasitic diodes operate, such as applying a voltage that is lower than the GND (P substrate) voltage to an input pin, should not be used.

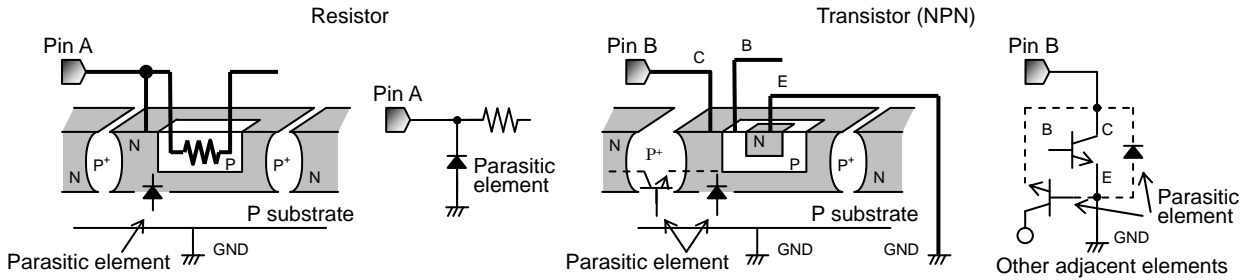

12. Ground Wiring Pattern

When using both small signal and large current GND patterns, it is recommended to isolate the two ground patterns, placing a single ground point at the ground potential of application so that the pattern wiring resistance and voltage variations caused by large currents do not cause variations in the small signal ground voltage. Be careful not to change the GND wiring pattern of any external components, either.

• Heat Dissipation Characteristics

©HQFN20V

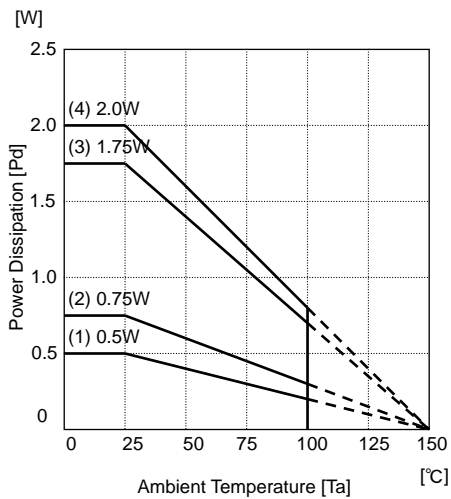

- (1) IC unit
 $\theta_{j-a}=250^{\circ}\text{C}/\text{W}$
- (2) Substrate (Bottom surface copper foil area: none)
 $\theta_{j-a}=166.7^{\circ}\text{C}/\text{W}$
- (3) Substrate (Bottom surface copper foil area: 60mm×60mm...1 layer)
 $\theta_{j-a}=71.4^{\circ}\text{C}/\text{W}$
- (4) Substrate (Bottom surface copper foil area: 60mm×60mm...2 layers)
 $\theta_{j-a}=62.5^{\circ}\text{C}/\text{W}$

Notice

Precaution on using ROHM Products

- Our Products are designed and manufactured for application in ordinary electronic equipments (such as AV equipment, OA equipment, telecommunication equipment, home electronic appliances, amusement equipment, etc.). If you intend to use our Products in devices requiring extremely high reliability (such as medical equipment ^(Note 1), transport equipment, traffic equipment, aircraft/spacecraft, nuclear power controllers, fuel controllers, car equipment including car accessories, safety devices, etc.) and whose malfunction or failure may cause loss of human life, bodily injury or serious damage to property ("Specific Applications"), please consult with the ROHM sales representative in advance. Unless otherwise agreed in writing by ROHM in advance, ROHM shall not be in any way responsible or liable for any damages, expenses or losses incurred by you or third parties arising from the use of any ROHM's Products for Specific Applications.

(Note1) Medical Equipment Classification of the Specific Applications

JAPAN	USA	EU	CHINA
CLASS III	CLASS III	CLASS II b	CLASS III
CLASS IV		CLASS III	

- ROHM designs and manufactures its Products subject to strict quality control system. However, semiconductor products can fail or malfunction at a certain rate. Please be sure to implement, at your own responsibilities, adequate safety measures including but not limited to fail-safe design against the physical injury, damage to any property, which a failure or malfunction of our Products may cause. The following are examples of safety measures:
 - Installation of protection circuits or other protective devices to improve system safety
 - Installation of redundant circuits to reduce the impact of single or multiple circuit failure
- Our Products are designed and manufactured for use under standard conditions and not under any special or extraordinary environments or conditions, as exemplified below. Accordingly, ROHM shall not be in any way responsible or liable for any damages, expenses or losses arising from the use of any ROHM's Products under any special or extraordinary environments or conditions. If you intend to use our Products under any special or extraordinary environments or conditions (as exemplified below), your independent verification and confirmation of product performance, reliability, etc. prior to use, must be necessary:
 - Use of our Products in any types of liquid, including water, oils, chemicals, and organic solvents
 - Use of our Products outdoors or in places where the Products are exposed to direct sunlight or dust
 - Use of our Products in places where the Products are exposed to sea wind or corrosive gases, including Cl₂, H₂S, NH₃, SO₂, and NO₂
 - Use of our Products in places where the Products are exposed to static electricity or electromagnetic waves
 - Use of our Products in proximity to heat-producing components, plastic cords, or other flammable items
 - Sealing or coating our Products with resin or other coating materials
 - Use of our Products without cleaning residue of flux (even if you use no-clean type fluxes, cleaning residue of flux is recommended); or Washing our Products by using water or water-soluble cleaning agents for cleaning residue after soldering
 - Use of the Products in places subject to dew condensation
- The Products are not subject to radiation-proof design.
- Please verify and confirm characteristics of the final or mounted products in using the Products.
- In particular, if a transient load (a large amount of load applied in a short period of time, such as pulse. is applied, confirmation of performance characteristics after on-board mounting is strongly recommended. Avoid applying power exceeding normal rated power; exceeding the power rating under steady-state loading condition may negatively affect product performance and reliability.
- De-rate Power Dissipation (Pd) depending on Ambient temperature (Ta). When used in sealed area, confirm the actual ambient temperature.
- Confirm that operation temperature is within the specified range described in the product specification.
- ROHM shall not be in any way responsible or liable for failure induced under deviant condition from what is defined in this document.

Precaution for Mounting / Circuit board design

- When a highly active halogenous (chlorine, bromine, etc.) flux is used, the residue of flux may negatively affect product performance and reliability.
- In principle, the reflow soldering method must be used; if flow soldering method is preferred, please consult with the ROHM representative in advance.

For details, please refer to ROHM Mounting specification

Precautions Regarding Application Examples and External Circuits

1. If change is made to the constant of an external circuit, please allow a sufficient margin considering variations of the characteristics of the Products and external components, including transient characteristics, as well as static characteristics.
2. You agree that application notes, reference designs, and associated data and information contained in this document are presented only as guidance for Products use. Therefore, in case you use such information, you are solely responsible for it and you must exercise your own independent verification and judgment in the use of such information contained in this document. ROHM shall not be in any way responsible or liable for any damages, expenses or losses incurred by you or third parties arising from the use of such information.

Precaution for Electrostatic

This Product is electrostatic sensitive product, which may be damaged due to electrostatic discharge. Please take proper caution in your manufacturing process and storage so that voltage exceeding the Products maximum rating will not be applied to Products. Please take special care under dry condition (e.g. Grounding of human body / equipment / solder iron, isolation from charged objects, setting of ionizer, friction prevention and temperature / humidity control).

Precaution for Storage / Transportation

1. Product performance and soldered connections may deteriorate if the Products are stored in the places where:
 - [a] the Products are exposed to sea winds or corrosive gases, including Cl₂, H₂S, NH₃, SO₂, and NO₂
 - [b] the temperature or humidity exceeds those recommended by ROHM
 - [c] the Products are exposed to direct sunshine or condensation
 - [d] the Products are exposed to high Electrostatic
2. Even under ROHM recommended storage condition, solderability of products out of recommended storage time period may be degraded. It is strongly recommended to confirm solderability before using Products of which storage time is exceeding the recommended storage time period.
3. Store / transport cartons in the correct direction, which is indicated on a carton with a symbol. Otherwise bent leads may occur due to excessive stress applied when dropping of a carton.
4. Use Products within the specified time after opening a humidity barrier bag. Baking is required before using Products of which storage time is exceeding the recommended storage time period.

Precaution for Product Label

QR code printed on ROHM Products label is for ROHM's internal use only.

Precaution for Disposition

When disposing Products please dispose them properly using an authorized industry waste company.

Precaution for Foreign Exchange and Foreign Trade act

Since our Products might fall under controlled goods prescribed by the applicable foreign exchange and foreign trade act, please consult with ROHM representative in case of export.

Precaution Regarding Intellectual Property Rights

1. All information and data including but not limited to application example contained in this document is for reference only. ROHM does not warrant that foregoing information or data will not infringe any intellectual property rights or any other rights of any third party regarding such information or data. ROHM shall not be in any way responsible or liable for infringement of any intellectual property rights or other damages arising from use of such information or data.:
2. No license, expressly or implied, is granted hereby under any intellectual property rights or other rights of ROHM or any third parties with respect to the information contained in this document.

Other Precaution

1. This document may not be reprinted or reproduced, in whole or in part, without prior written consent of ROHM.
2. The Products may not be disassembled, converted, modified, reproduced or otherwise changed without prior written consent of ROHM.
3. In no event shall you use in any way whatsoever the Products and the related technical information contained in the Products or this document for any military purposes, including but not limited to, the development of mass-destruction weapons.
4. The proper names of companies or products described in this document are trademarks or registered trademarks of ROHM, its affiliated companies or third parties.

General Precaution

1. Before you use our Products, you are requested to carefully read this document and fully understand its contents. ROHM shall not be in any way responsible or liable for failure, malfunction or accident arising from the use of any ROHM's Products against warning, caution or note contained in this document.
2. All information contained in this document is current as of the issuing date and subject to change without any prior notice. Before purchasing or using ROHM's Products, please confirm the latest information with a ROHM sales representative.
3. The information contained in this document is provided on an "as is" basis and ROHM does not warrant that all information contained in this document is accurate and/or error-free. ROHM shall not be in any way responsible or liable for any damages, expenses or losses incurred by you or third parties resulting from inaccuracy or errors of or concerning such information.