

Pin Configuration

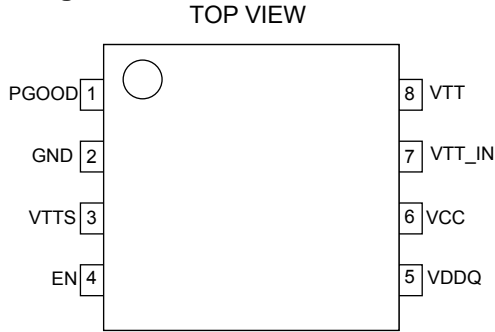

Pin Descriptions

Pin No.	Pin Name	Pin Function
1	PGOOD	PGOOD output pin
2	GND	GND
3	VTTS	Detector pin for termination voltage
4	EN	ENABLE input pin
5	VDDQ	Reference voltage input pin
6	VCC	VCC pin
7	VTT_IN	Termination power supply pin
8	VTT	Termination output pin

Description of Blocks

1. VCC

The VCC pin is for the independent power supply input that operates the internal circuit of the IC. It is the voltage at this pin that drives the IC's amplifier circuits. The VCC input ranges from 2.7V to 5V and maximum current consumption is 4mA. A bypass capacitor of 1 μ F or so should be connected to this pin when using the IC in an application circuit.

2. VDDQ

This is the power supply input pin for an internal voltage divider network. The voltage at VDDQ is halved by two 50k Ω internal voltage-divider resistors and the resulting voltage serves as reference for the VTT output. Since $V_{TT} = 1/2V_{DDQ}$, the JEDEC requirement for DDR1/2/3-SDRAM can be satisfied by supplying the correct voltage to VDDQ. Noise input should be avoided at the VDDQ pin as it is also included by the voltage-divider at the output. An RC filter consisting of a resistor and a capacitor (220 Ω and 2.2 μ F, for instance,) may be used to reduce the noise input but make sure that it will not significantly affect the voltage-divider's output.

3. VTT_IN

VTT_IN is the power supply input pin for the VTT output. Input voltage may range from 1.0V to 5.5V, but consideration must be given to the current limit dictated by the ON-Resistance of the IC and to the change in allowable loss due to input/output voltage difference.

Generally, the following voltages are supplied:

- DDR1 VTT_IN = 2.5V
- DDR2 VTT_IN = 1.8V
- DDR3 VTT_IN = 1.5V

Take note that a high-impedance voltage input at VTT_IN may result in oscillation or degradation in ripple rejection, so connecting a 10 μ F capacitor with minimal change in capacitance to VTT_IN terminal is recommended. However, this impedance may depend on the characteristics of the power supply input and the impedance of the PC board wiring, which must be carefully checked before use.

4. PGOOD

PGOOD is the power good output pin. This is an open-drain pin so it should be connected to a power supply via a pull-up resistor. If VTT voltage becomes over $1/2V_{DDQ}+30\text{mV}$, or under $1/2V_{DDQ}-30\text{mV}$, it outputs a "High" voltage.

5. VTTS

VTTS is a sense pin for the load regulation of the VTT output voltage. In case the wire connecting VTT pin and the load is too long, connecting VTTS pin to the part of the wire nearer to the load may improve load regulation.

VTTS terminal is High impedance terminal. Therefore it is easy to be affected by the noise. The stable operation of the IC is possible by inserting RC filter (e.g., R=200 Ω , C=1000pF) near VTTS terminal.

6. VTT

This is the output pin for the DDR memory termination voltage and it has a sink/source current capability of $\pm 1.0\text{A}$. VTT voltage tracks the voltage at VDDQ pin divided in half. The output is turned OFF when EN pin is "Low" or when either the VCC UVLO or the thermal shutdown protection function is activated.

Always connect a capacitor to VTT pin for loop gain and phase compensation and for reduction in output voltage variation in the event of sudden load change. Be careful in choosing the capacitor as insufficient capacitance may cause oscillation and high ESR (Equivalent Series Resistance) may result in increased output voltage variation during a sudden change in load. A 10 μ F or so ceramic capacitor is recommended, though ambient temperature and other conditions should also be considered.

7. EN

A "High" input of 2.3V or higher to EN turns ON the VTT output. A "Low" input of 0.8V or less, on the other hand, turns VTT to a Hi-Z state. When EN terminal repeats ON/OFF, an inrush current may flow in VTT_IN terminal. Please be careful about voltage Drop of the VTT_IN line.

Absolute Maximum Ratings

Parameter	Symbol	Rating	Unit
Input Voltage	V _{CC}	7 (Note 1) (Note 2)	V
Enable Input Voltage	V _{EN}	7 (Note 1) (Note 2)	V
Termination Input Voltage	V _{TT_IN}	7 (Note 1) (Note 2)	V
VDDQ Reference Voltage	V _{DDQ}	7 (Note 1) (Note 2)	V
Output Current	I _{TT1}	1 (Note 1)	A
Output Current (When Pulse is Active) (Note 3)	I _{TT2}	3 (Note 1)	A
Power Dissipation1	Pd1	0.56 (Note 4)	W
Power Dissipation2	Pd2	0.67 (Note 5)	W
Operating Temperature Range	Topr	-30 to +100	°C
Storage Temperature Range	Tstg	-55 to +150	°C
Maximum Junction Temperature	Tjmax	+150	°C

(Note 1) Should not exceed Pd.

(Note 2) Instantaneous surge voltage, back electromotive force and voltage under less than 10% duty cycle.

(Note 3) Voltage under less than 10u sec.

(Note 4) Reduce by 4.50mW/°C for Ta over 25°C (when not mounted on a heat radiation board)

(Note 5) Reduce by 5.40mW/°C for Ta over 25°C (when mounted on a 70mmx70mmx1.6mm glass epoxy board)

Caution: Operating the IC over the absolute maximum ratings may damage the IC. In addition, it is impossible to predict all destructive situations such as short-circuit modes, open circuit modes, etc. Therefore, it is important to consider circuit protection measures, like adding a fuse, in case the IC is operated in a special mode exceeding the absolute maximum ratings

Recommended Operating Conditions (Ta=25°C)

Parameter	Symbol	Rating		Unit
		Min	Max	
Input Voltage	V _{CC}	2.7	5.5	V
Termination Input Voltage	V _{TT_IN}	1.0	5.5	V
VDDQ Reference Voltage	V _{DDQ}	1.0	2.75	V
Enable Input Voltage	V _{EN}	-0.3	+5.5	V

Electrical Characteristics

(Unless otherwise noted, Ta=25°C, V_{CC}=3.3V, V_{EN}=3V, V_{DDQ}=1.8V, V_{TT_IN}=1.8V)

Parameter	Symbol	Limit			Unit	Conditions
		Min	Typ	Max		
Standby Current	I _{STBY}	-	0.5	1.0	mA	V _{EN} =0V
Circuit Current	I _{CC}	-	2	4	mA	V _{EN} =3V
[Enable]						
High Level Enable Input Voltage	V _{ENHIGH}	2.3	-	5.5	V	
Low Level Enable Input Voltage	V _{ENLOW}	-0.3	-	+0.8	V	
Enable Pin Input Current	I _{EN}	-	7	10	μA	V _{EN} =3V
[Termination]						
Termination Output Voltage (DDR2)	V _{TT2}	1/2xV _{DDQ} -30m	1/2xV _{DDQ}	1/2xV _{DDQ} +30m	V	I _{TT} =-1.0A to +1.0A Ta=0°C to 100°C
Termination Output Voltage (DDR1)	V _{TT1}	1/2xV _{DDQ} -30m	1/2xV _{DDQ}	1/2xV _{DDQ} +30m	V	V _{CC} = 5.0V, V _{DDQ} = 2.5V V _{TT_IN} = 2.5V I _{TT} =-1.0A to +1.0A Ta=0°C to 100°C
Termination Output Voltage (DDR3)	V _{TT3}	1/2xV _{DDQ} -15m	1/2xV _{DDQ}	1/2xV _{DDQ} +15m	V	V _{CC} = 3.3V, V _{DDQ} = 1.5V V _{TT_IN} = 1.5V I _{TT} =-1.0A to +1.0A Ta=0°C to 100°C
Source Current	I _{TT+}	1.0	-	-	A	
Sink Current	I _{TT-}	-	-	-1.0	A	
Load Regulation	ΔV _{TT}	-	-	50	mV	I _{TT} =-1.0A to +1.0A
Upper Side ON-Resistance	R _{ON_H}	-	0.35	0.65	Ω	
Lower Side ON-Resistance	R _{ON_L}	-	0.35	0.65	Ω	
[VREF]						
Input Impedance	Z _{VDDQ}	140	200	260	kΩ	
[PGOOD]						
VTT PGOOD Low Threshold Voltage	V _{PGDLow}	-	1/2xV _{DDQ} -30m	-	V	
VTT PGOOD High Threshold Voltage	V _{PGDHigh}	-	1/2xV _{DDQ} +30m	-	V	
PGOOD Output ON Resistor	R _{PGD}	-	10	20	Ω	
PGOOD Output Leakage Current	I _{PGD}	-	-	1	μA	V _{PGOOD} =6V
PGOOD Delay Time	t _{PGD}	1	2	4	ms	
[UVLO]						
Threshold Voltage	V _{UVLO}	2.35	2.50	2.65	V	V _{CC} : sweep up
Hysteresis Voltage	ΔV _{UVLO}	120	180	240	mV	V _{CC} : sweep down

Typical Performance Curves

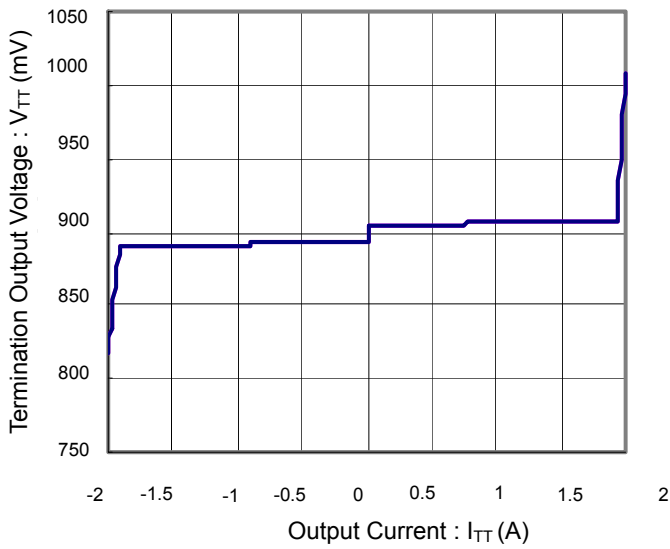

Figure 1. Termination Output Voltage vs Output Current (DDR2)

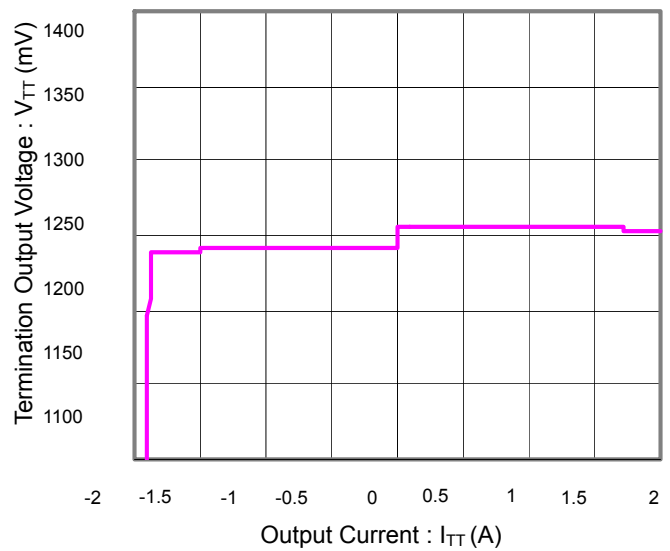

Figure 2. Termination Output Voltage vs Output Current (DDR1)

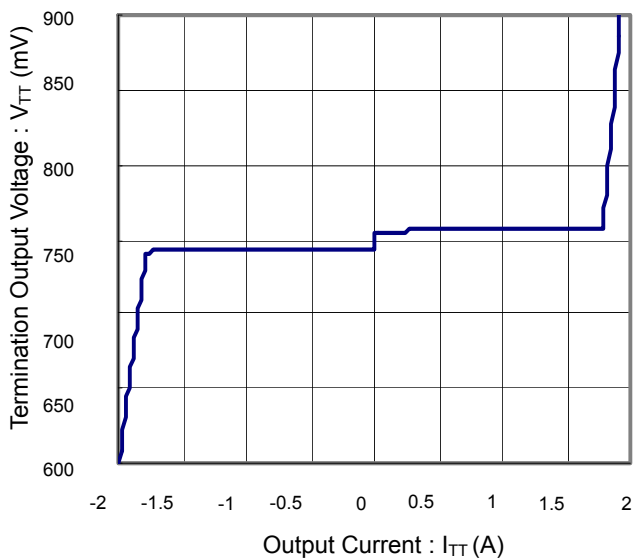

Figure 3. Termination Output Voltage vs Output Current (DDR3)

Typical Waveforms

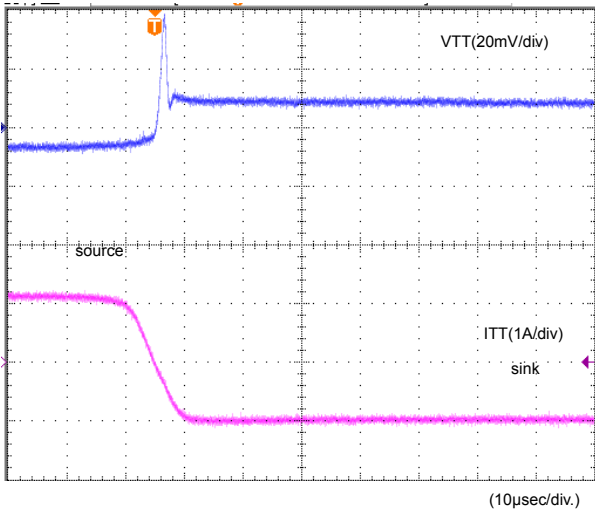

Figure 4. DDR3 (+1A to -1A)

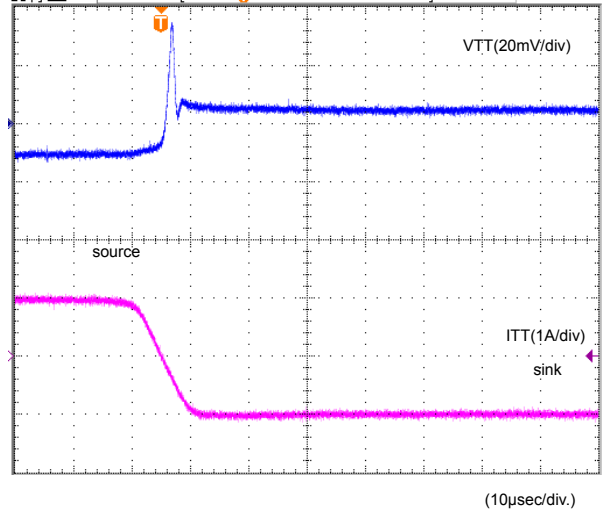

Figure 5. DDR2 (+1A to -1A)

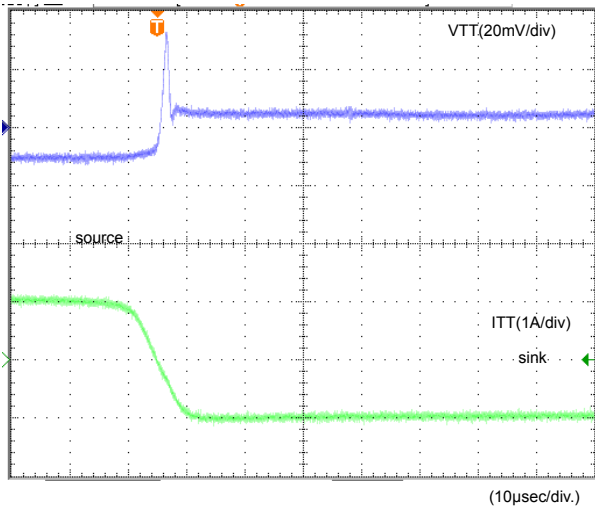

Figure 6. DDR1 (+1A to -1A)

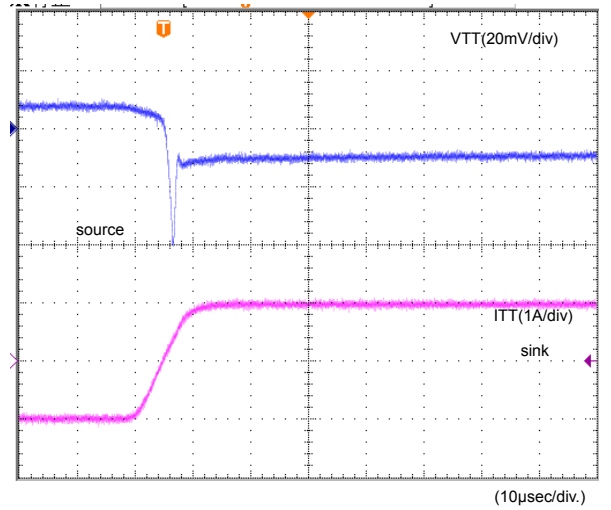

Figure 7. DDR3 (-1A to +1A)

Typical Waveforms – continued

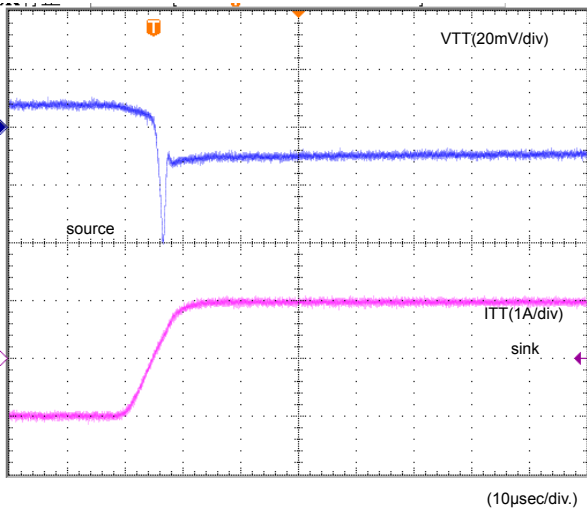

Figure 8. DDR2 (-1A to +1A)

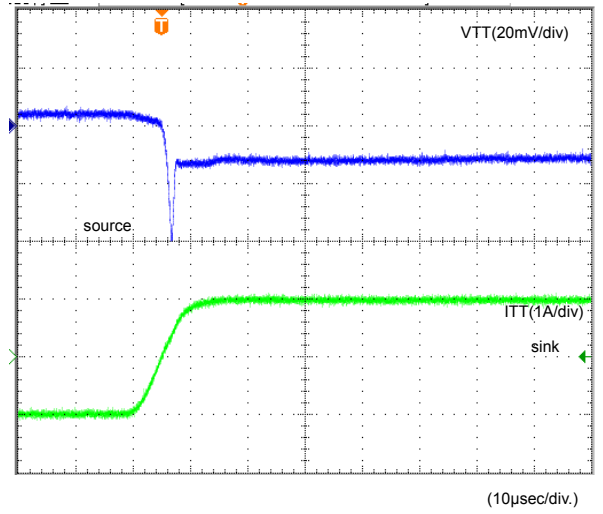

Figure 9. DDR1 (-1A to +1A)

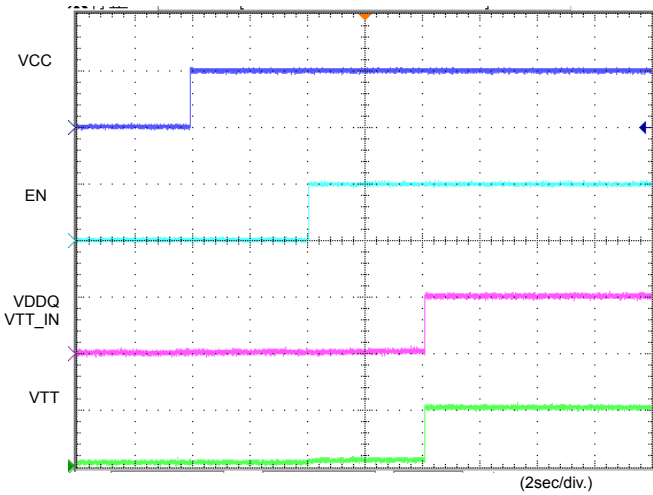

Figure 10. Input Sequence1

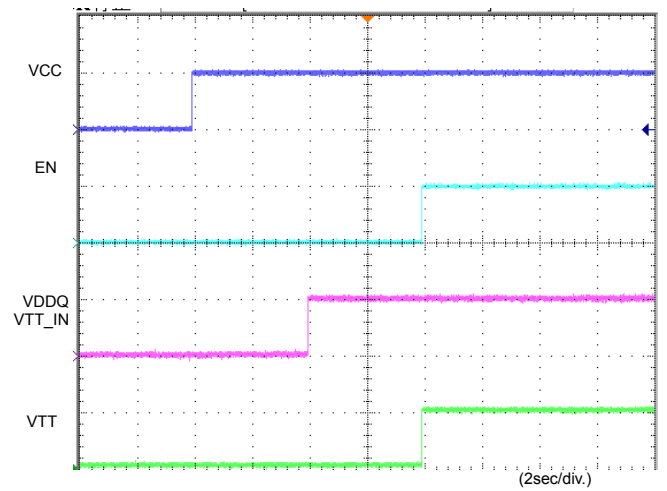

Figure 11. Input Sequence2

Typical Waveforms – continued

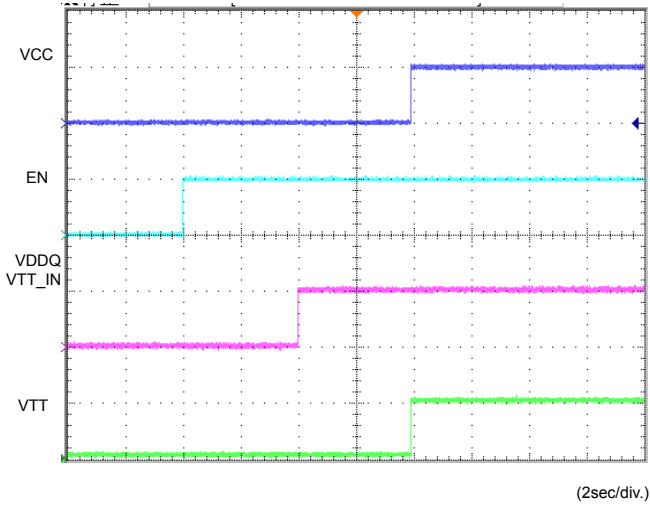

Figure 12. Input Sequence3

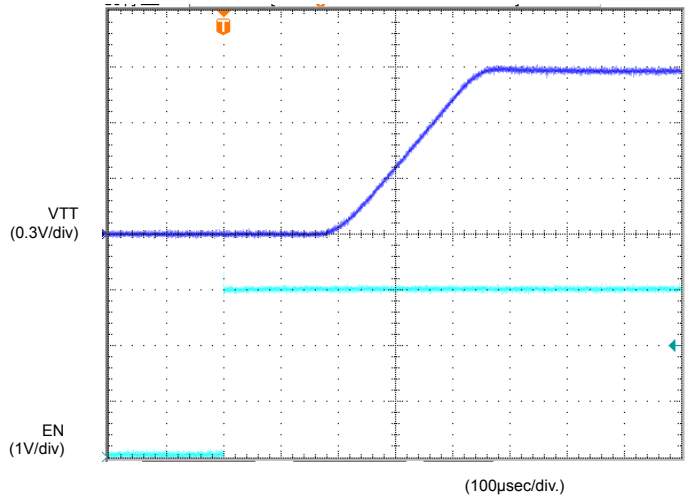

Figure 13. EN Soft Start (DDR2)

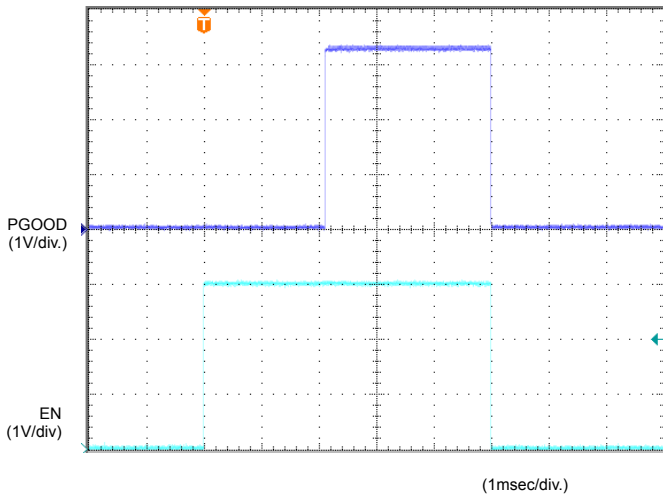

Figure 14. PGOOD Delay (Start up-Shut down)

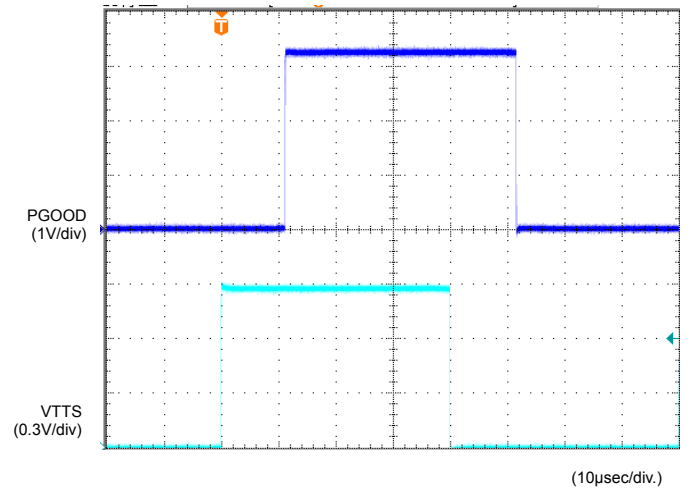
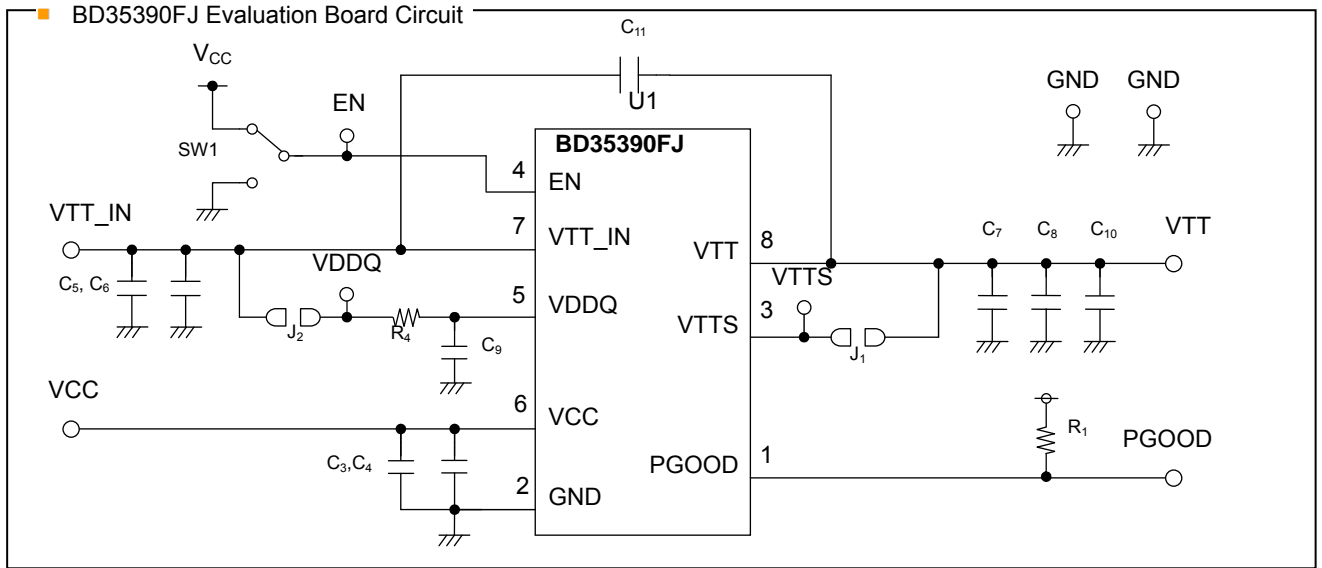

Figure 15. PGOOD Delay (TSD OFF-TSD ON)

Application Information

1. Evaluation Board



■ BD35390FJ Evaluation Board Application Components

Designation	Value	Company	Part No.
U1	-	ROHM	BD35390FJ
R1	10kΩ	ROHM	MCR031002
R4	220Ω	ROHM	MCR032200
J1	0Ω	-	-
J2	0Ω	-	-
C3	1μF	KYOCERA	CM105B105K06A
C4	-	-	-

Designation	Value	Company	Part No.
C5	10μF	KYOCERA	CM21B106M06A
C6	-	-	-
C7	10μF	KYOCERA	CM21B106M06A
C8	-	-	-
C9	2.2μF	KYOCERA	CM105B225K06A
C10	-	-	-
C11	-	-	-

2. Power Dissipation

In thermal design, consider the temperature range wherein the IC is guaranteed to operate and apply appropriate margins. The temperature conditions that need to be considered are listed below:

- (1) Ambient temperature Ta: 100°C or lower
- (2) Chip junction temperature Tj: 150°C or lower

The chip junction temperature Tj can be considered as follows:

Most heat loss in BD35390FJ occurs at the output N-channel FET. The lost power is determined by multiplying the voltage between IN and OUT by the output current. Since this IC is packaged for high-power applications, its thermal derating characteristics significantly depend on the PC board. So when designing, the size of the PC board to be used should be carefully considered.

$$\text{Power consumption (W)} = \text{Input voltage (V}_{TT_IN}) - \text{Output Voltage (V}_{TT} \approx 1/2V_{DDQ}) \times I_{OUT} \text{ (Ave)}$$

Example) Where $V_{TT_IN} = 1.8V$, $V_{DDQ} = 1.8V$, $I_{OUT} \text{ (Ave)} = 0.5A$

$$\begin{aligned} \text{Power consumption (W)} &= \{1.8(V) - 0.9(V)\} \times 0.5(A) \\ &= 0.45(W) \end{aligned}$$

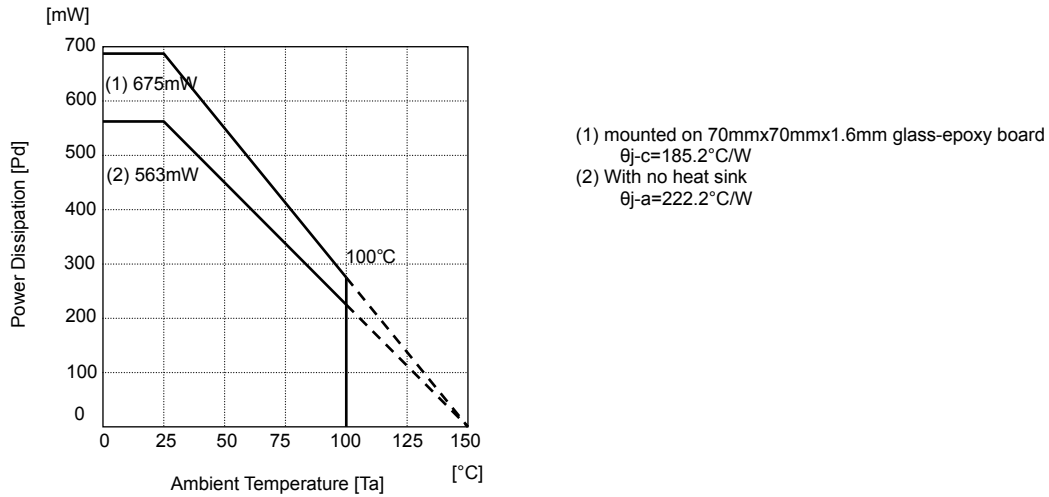

Operational Notes

- 1. Reverse Connection of Power Supply**

Connecting the power supply in reverse polarity can damage the IC. Take precautions against reverse polarity when connecting the power supply, such as mounting an external diode between the power supply and the IC's power supply terminals.
- 2. Power Supply Lines**

Design the PCB layout pattern to provide low impedance supply lines. Separate the ground and supply lines of the digital and analog blocks to prevent noise in the ground and supply lines of the digital block from affecting the analog block. Furthermore, connect a capacitor to ground at all power supply pins. Consider the effect of temperature and aging on the capacitance value when using electrolytic capacitors.
- 3. Ground Voltage**

Ensure that no pins are at a voltage below that of the ground pin at any time, even during transient condition.
- 4. Ground Wiring Pattern**

When using both small-signal and large-current ground traces, the two ground traces should be routed separately but connected to a single ground at the reference point of the application board to avoid fluctuations in the small-signal ground caused by large currents. Also ensure that the ground traces of external components do not cause variations on the ground voltage. The ground lines must be as short and thick as possible to reduce line impedance.
- 5. Thermal Consideration**

Should by any chance the power dissipation rating be exceeded, the rise in temperature of the chip may result in deterioration of the properties of the chip. The absolute maximum rating of the Pd stated in this specification is when the IC is mounted on a 70mm x 70mm x 1.6mm glass epoxy board. In case of exceeding this absolute maximum rating, increase the board size and copper area to prevent exceeding the Pd rating.
- 6. Recommended Operating Conditions**

These conditions represent a range within which the expected characteristics of the IC can be approximately obtained. The electrical characteristics are guaranteed under the conditions of each parameter.
- 7. Inrush Current**

When power is first supplied to the IC, it is possible that the internal logic may be unstable and inrush current may flow instantaneously due to the internal powering sequence and delays, especially if the IC has more than one power supply. Therefore, give special consideration to power coupling capacitance, power wiring, width of ground wiring, and routing of connections.
- 8. Operation Under Strong Electromagnetic Field**

Operating the IC in the presence of a strong electromagnetic field may cause the IC to malfunction.
- 9. Testing on Application Boards**

When testing the IC on an application board, connecting a capacitor directly to a low-impedance output pin may subject the IC to stress. Always discharge capacitors completely after each process or step. The IC's power supply should always be turned OFF completely before connecting or removing it from the test setup during the inspection process. To prevent damage from static discharge, ground the IC during assembly and use similar precautions during transport and storage.
- 10. Inter-pin Short and Mounting Errors**

Ensure that the direction and position are correct when mounting the IC on the PCB. Incorrect mounting may result in damaging the IC. Avoid nearby pins being shorted to each other especially to ground, power supply and output pin. Inter-pin shorts could be due to many reasons such as metal particles, water droplets (in very humid environment) and unintentional solder bridge deposited in between pins during assembly to name a few.
- 11. Unused Input Terminals**

Input terminals of an IC are often connected to the gate of a MOS transistor. The gate has extremely high impedance and extremely low capacitance. If left unconnected, the electric field from the outside can easily charge it. The small charge acquired in this way is enough to produce a significant effect on the conduction through the transistor and cause unexpected operation of the IC. So unless otherwise specified, unused input terminals should be connected to the power supply or ground line.

Operational Notes – continued

12. Regarding Input Pins of the IC

This monolithic IC contains P+ isolation and P substrate layers between adjacent elements in order to keep them isolated. P-N junctions are formed at the intersection of the P layers with the N layers of other elements, creating a parasitic diode or transistor. For example (refer to figure below):

When $GND > Pin\ A$ and $GND > Pin\ B$, the P-N junction operates as a parasitic diode.

When $GND > Pin\ B$, the P-N junction operates as a parasitic transistor.

Parasitic diodes inevitably occur in the structure of the IC. The operation of parasitic diodes can result in mutual interference among circuits, operational faults, or physical damage. Therefore, conditions that cause these diodes to operate, such as applying a voltage lower than the GND voltage to an input pin (and thus to the P substrate) should be avoided.

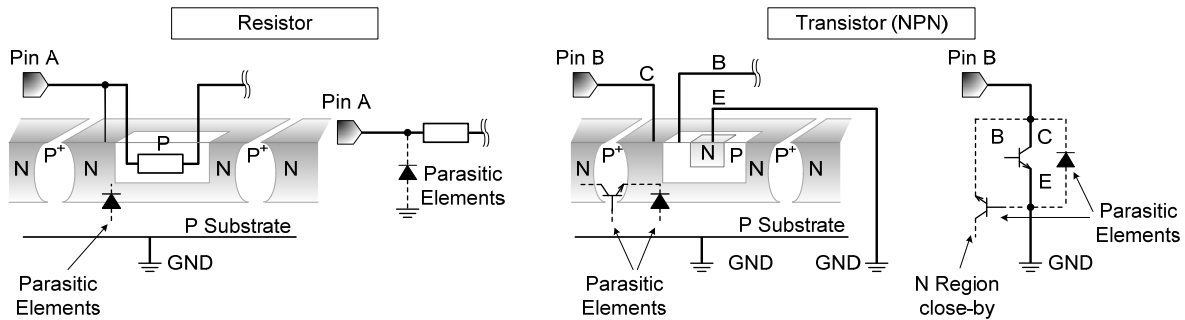

Figure 16. Example of Monolithic IC Structure

13. Thermal Shutdown Circuit(TSD)

This IC has a built-in thermal shutdown circuit that prevents heat damage to the IC. Normal operation should always be within the IC's power dissipation rating. If however the rating is exceeded for a continued period, the junction temperature (T_j) will rise which will activate the TSD circuit that will turn OFF all output pins. When the T_j falls below the TSD threshold, the circuits are automatically restored to normal operation.

Note that the TSD circuit operates in a situation that exceeds the absolute maximum ratings and therefore, under no circumstances, should the TSD circuit be used in a set design or for any purpose other than protecting the IC from heat damage.

The present IC incorporates a thermal shutdown protection circuit (TSD circuit). The working temperature is 175°C (standard value) and has a -15°C (standard value) hysteresis width.

14. Capacitor Across Output and Ground

In a large capacitor is connected between the output pin and ground pin, current from the charged capacitor can flow into the output pin and may destroy the IC when the VCC or VTT_IN pin is shorted to ground or pulled down to 0V. Use a capacitor smaller than $1000\mu\text{F}$ between output and ground.

15. Output Capacitor (C_7)

Do not fail to connect a capacitor to VTT output pin for stabilization of output voltage. This output capacitor works as a loop gain phase compensator and an output voltage variation reducer in the event of sudden change in load. Insufficient capacitance may cause oscillation. And if the equivalent series resistance (ESR) of this capacitor is high, the variation in output voltage increases in the event of sudden change in load. It is recommended to use a $10\mu\text{F}$ or so ceramic capacitor, though it depends on ambient temperature and load conditions. It is therefore requested to carefully check under the actual temperature and load conditions to be applied.

16. Input Capacitors Setting (C_3 and C_5)

These input capacitors are used to reduce the output impedance of power supply to be connected to the input terminals (VCC and VTT_IN). Increase in the power supply output impedance may result in oscillation or degradation in ripple rejecting characteristics. It is recommended to use a low temperature coefficient $1\mu\text{F}$ (for VCC) and $10\mu\text{F}$ (for VTT_IN) capacitor, but it depends on the characteristics of the power supply input, and the capacitance and impedance of the pc board wiring pattern. It is therefore requested to carefully check under the actual temperature and load conditions to be applied.

Operational Notes – continued

17. Input Terminals (VCC, VDDQ, VTT_IN and EN)

VCC, VDDQ, VTT_IN and EN terminals of this IC are made up independent one another. To VCC terminal, the UVLO function is provided for malfunction protection. Irrespective of the input order of the inputs terminals, VTT output is activated to provide the output voltage when UXLO and EN voltages reach the threshold voltage while VREF output is activated when UXLO voltage reaches the threshold. If VDDQ and VTT_IN terminals have equal potential and common impedance, any change in current at VTT_IN terminal may result in variation of VTT_IN voltage, which affects VDDQ terminal and may cause variation in the output voltage. It is therefore required to perform wiring in such manner that VDDQ and VTT_IN terminals may not have common impedance. If impossible, take appropriate corrective measures including suitable CR filter to be inserted between VDDQ and VTT_IN terminals.

18. VTTTS Terminal

This terminal is used to improve load regulation of VTT output. The connection with VTT terminal must be done so that it would not have a common impedance with high current line for better load regulation of VTT output.

19. Operating Range

Within the operating range, the operation and function of the circuits are generally guaranteed at an ambient temperature within the range specified. The values specified for electrical characteristics may not be guaranteed, but drastic change may not occur to such characteristics within the operating range.

20. Allowable Loss Pd

For the allowable loss, the thermal derating characteristics are shown in the Exhibit, which should be used as a guide. Any uses that exceed the allowable loss may result in degradation in the functions inherent to IC including a decrease in current capability due to chip temperature increase. Use within the allowable loss.

21. Thermal Shutdown Circuits

This IC incorporates a built-in-thermal shutdown circuit, to prevent the IC from thermal breaking down. In thermal shut down circuit operation, VTT output turns to be OFF. The thermal shut down circuit is originally designed to protect the incorporated IC, so that thermal design needs to be designed below the temperature, which enables to run the thermal shut down circuits.

22. The use of the IC in a strong electromagnetic field may sometimes cause malfunction, to which care must be taken. In the event that a load containing a large inductance component is connected to the output terminal, and generation of back-EMF at the start-up and when output is turned OFF is assumed, it is requested to insert a protection diode.

23. In the event that a load containing a large inductance component is connected to the output terminal, and generation of back-EMF at the start-up and when output is turned OFF is assumed, it is requested to insert a protection diode.

(Example)

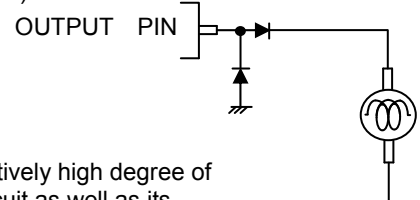

24. Application Circuit

Although we can recommend the application circuits contained herein with a relatively high degree of confidence, we ask that you verify all characteristics and specifications of the circuit as well as its performance under actual conditions. Please note that we cannot be held responsible for problems that may arise due to patent infringements or noncompliance with any and all applicable laws and regulations.

Ordering Information

B D 3 5 3 9 0 F J

E2

Part Number

Package
FJ : SOP-J8

Packaging and forming specification
E2: Embossed tape and reel

Marking Diagram

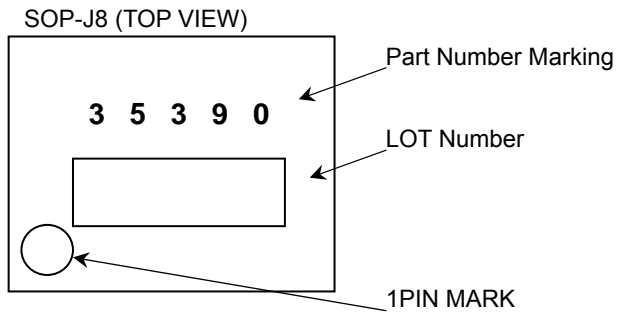

Part Number Marking	Package	Orderable Part Number
35390	SOP-J8	BD35390FJ-E2

Physical Dimension, Tape and Reel Information

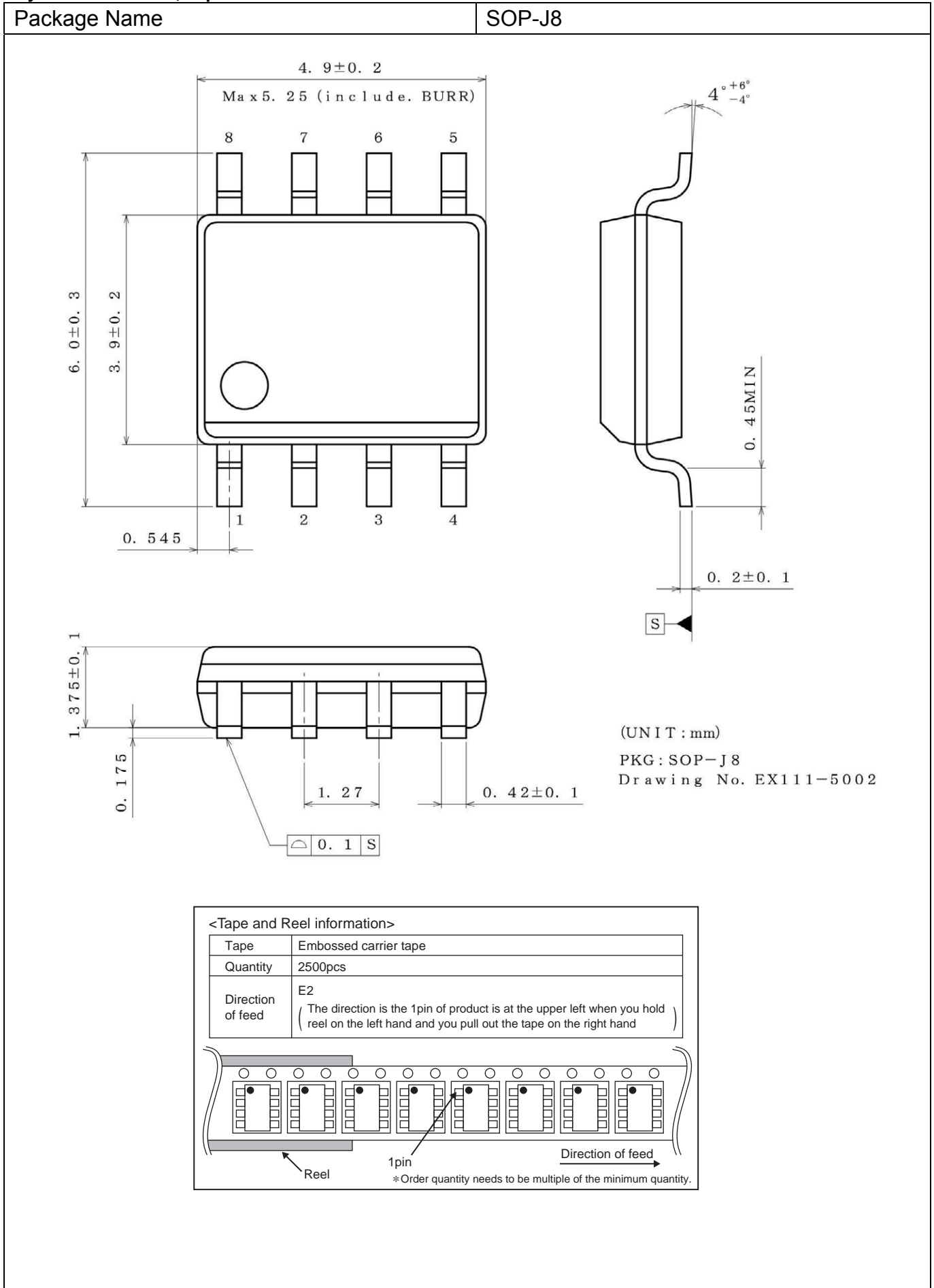

Revision History

Date	Revision	Changes
07.Mar.2014	001	New Release
22.Jul.2015	002	Revised Applications

Notice

Precaution on using ROHM Products

- Our Products are designed and manufactured for application in ordinary electronic equipments (such as AV equipment, OA equipment, telecommunication equipment, home electronic appliances, amusement equipment, etc.). If you intend to use our Products in devices requiring extremely high reliability (such as medical equipment ^(Note 1), transport equipment, traffic equipment, aircraft/spacecraft, nuclear power controllers, fuel controllers, car equipment including car accessories, safety devices, etc.) and whose malfunction or failure may cause loss of human life, bodily injury or serious damage to property ("Specific Applications"), please consult with the ROHM sales representative in advance. Unless otherwise agreed in writing by ROHM in advance, ROHM shall not be in any way responsible or liable for any damages, expenses or losses incurred by you or third parties arising from the use of any ROHM's Products for Specific Applications.

(Note1) Medical Equipment Classification of the Specific Applications

JAPAN	USA	EU	CHINA
CLASS III	CLASS III	CLASS II b	CLASS III
CLASS IV		CLASS III	

- ROHM designs and manufactures its Products subject to strict quality control system. However, semiconductor products can fail or malfunction at a certain rate. Please be sure to implement, at your own responsibilities, adequate safety measures including but not limited to fail-safe design against the physical injury, damage to any property, which a failure or malfunction of our Products may cause. The following are examples of safety measures:
 - Installation of protection circuits or other protective devices to improve system safety
 - Installation of redundant circuits to reduce the impact of single or multiple circuit failure
- Our Products are designed and manufactured for use under standard conditions and not under any special or extraordinary environments or conditions, as exemplified below. Accordingly, ROHM shall not be in any way responsible or liable for any damages, expenses or losses arising from the use of any ROHM's Products under any special or extraordinary environments or conditions. If you intend to use our Products under any special or extraordinary environments or conditions (as exemplified below), your independent verification and confirmation of product performance, reliability, etc. prior to use, must be necessary:
 - Use of our Products in any types of liquid, including water, oils, chemicals, and organic solvents
 - Use of our Products outdoors or in places where the Products are exposed to direct sunlight or dust
 - Use of our Products in places where the Products are exposed to sea wind or corrosive gases, including Cl₂, H₂S, NH₃, SO₂, and NO₂
 - Use of our Products in places where the Products are exposed to static electricity or electromagnetic waves
 - Use of our Products in proximity to heat-producing components, plastic cords, or other flammable items
 - Sealing or coating our Products with resin or other coating materials
 - Use of our Products without cleaning residue of flux (even if you use no-clean type fluxes, cleaning residue of flux is recommended); or Washing our Products by using water or water-soluble cleaning agents for cleaning residue after soldering
 - Use of the Products in places subject to dew condensation
- The Products are not subject to radiation-proof design.
- Please verify and confirm characteristics of the final or mounted products in using the Products.
- In particular, if a transient load (a large amount of load applied in a short period of time, such as pulse. is applied, confirmation of performance characteristics after on-board mounting is strongly recommended. Avoid applying power exceeding normal rated power; exceeding the power rating under steady-state loading condition may negatively affect product performance and reliability.
- De-rate Power Dissipation (Pd) depending on Ambient temperature (Ta). When used in sealed area, confirm the actual ambient temperature.
- Confirm that operation temperature is within the specified range described in the product specification.
- ROHM shall not be in any way responsible or liable for failure induced under deviant condition from what is defined in this document.

Precaution for Mounting / Circuit board design

- When a highly active halogenous (chlorine, bromine, etc.) flux is used, the residue of flux may negatively affect product performance and reliability.
- In principle, the reflow soldering method must be used on a surface-mount products, the flow soldering method must be used on a through hole mount products. If the flow soldering method is preferred on a surface-mount products, please consult with the ROHM representative in advance.

For details, please refer to ROHM Mounting specification

Precautions Regarding Application Examples and External Circuits

1. If change is made to the constant of an external circuit, please allow a sufficient margin considering variations of the characteristics of the Products and external components, including transient characteristics, as well as static characteristics.
2. You agree that application notes, reference designs, and associated data and information contained in this document are presented only as guidance for Products use. Therefore, in case you use such information, you are solely responsible for it and you must exercise your own independent verification and judgment in the use of such information contained in this document. ROHM shall not be in any way responsible or liable for any damages, expenses or losses incurred by you or third parties arising from the use of such information.

Precaution for Electrostatic

This Product is electrostatic sensitive product, which may be damaged due to electrostatic discharge. Please take proper caution in your manufacturing process and storage so that voltage exceeding the Products maximum rating will not be applied to Products. Please take special care under dry condition (e.g. Grounding of human body / equipment / solder iron, isolation from charged objects, setting of Ionizer, friction prevention and temperature / humidity control).

Precaution for Storage / Transportation

1. Product performance and soldered connections may deteriorate if the Products are stored in the places where:
 - [a] the Products are exposed to sea winds or corrosive gases, including Cl₂, H₂S, NH₃, SO₂, and NO₂
 - [b] the temperature or humidity exceeds those recommended by ROHM
 - [c] the Products are exposed to direct sunshine or condensation
 - [d] the Products are exposed to high Electrostatic
2. Even under ROHM recommended storage condition, solderability of products out of recommended storage time period may be degraded. It is strongly recommended to confirm solderability before using Products of which storage time is exceeding the recommended storage time period.
3. Store / transport cartons in the correct direction, which is indicated on a carton with a symbol. Otherwise bent leads may occur due to excessive stress applied when dropping of a carton.
4. Use Products within the specified time after opening a humidity barrier bag. Baking is required before using Products of which storage time is exceeding the recommended storage time period.

Precaution for Product Label

QR code printed on ROHM Products label is for ROHM's internal use only.

Precaution for Disposition

When disposing Products please dispose them properly using an authorized industry waste company.

Precaution for Foreign Exchange and Foreign Trade act

Since concerned goods might be fallen under listed items of export control prescribed by Foreign exchange and Foreign trade act, please consult with ROHM in case of export.

Precaution Regarding Intellectual Property Rights

1. All information and data including but not limited to application example contained in this document is for reference only. ROHM does not warrant that foregoing information or data will not infringe any intellectual property rights or any other rights of any third party regarding such information or data.
2. ROHM shall not have any obligations where the claims, actions or demands arising from the combination of the Products with other articles such as components, circuits, systems or external equipment (including software).
3. No license, expressly or implied, is granted hereby under any intellectual property rights or other rights of ROHM or any third parties with respect to the Products or the information contained in this document. Provided, however, that ROHM will not assert its intellectual property rights or other rights against you or your customers to the extent necessary to manufacture or sell products containing the Products, subject to the terms and conditions herein.

Other Precaution

1. This document may not be reprinted or reproduced, in whole or in part, without prior written consent of ROHM.
2. The Products may not be disassembled, converted, modified, reproduced or otherwise changed without prior written consent of ROHM.
3. In no event shall you use in any way whatsoever the Products and the related technical information contained in the Products or this document for any military purposes, including but not limited to, the development of mass-destruction weapons.
4. The proper names of companies or products described in this document are trademarks or registered trademarks of ROHM, its affiliated companies or third parties.