

BD436, BD438, BD440, BD442

Plastic Medium Power Silicon PNP Transistor

This series of plastic, medium-power silicon PNP transistors can be used for amplifier and switching applications. Complementary types are BD437 and BD441.

Features

- Pb-Free Packages are Available*

MAXIMUM RATINGS

Rating	Symbol	Value	Unit	
Collector-Emitter Voltage	BD436 BD438 BD440 BD442	V_{CE0}	32 45 60 80	Vdc
Collector-Base Voltage	BD436 BD438 BD440 BD442	V_{CBO}	32 45 60 80	Vdc
Emitter-Base Voltage		V_{EBO}	5.0	Vdc
Collector Current		I_C	4.0	Adc
Base Current		I_B	1.0	Adc
Total Device Dissipation @ $T_C = 25^\circ\text{C}$ Derate above 25°C		P_D	36 288	W W/ $^\circ\text{C}$
Operating and Storage Junction Temperature Range		T_J, T_{stg}	-55 to +150	$^\circ\text{C}$

THERMAL CHARACTERISTICS

Characteristic	Symbol	Max	Unit
Thermal Resistance, Junction-to-Case	θ_{JC}	3.5	$^\circ\text{C}/\text{W}$

Maximum ratings are those values beyond which device damage can occur. Maximum ratings applied to the device are individual stress limit values (not normal operating conditions) and are not valid simultaneously. If these limits are exceeded, device functional operation is not implied, damage may occur and reliability may be affected.

*For additional information on our Pb-Free strategy and soldering details, please download the ON Semiconductor Soldering and Mounting Techniques Reference Manual, SOLDERRM/D.



ON Semiconductor®

<http://onsemi.com>

4.0 AMP POWER TRANSISTORS PNP SILICON

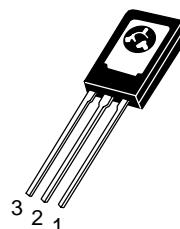

TO-225AA
CASE 77
STYLE 1

MARKING DIAGRAM

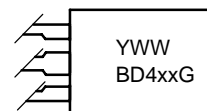

BD4xx = Device Code
 xx = 36, 36T, 38, 40, 42
Y = Year
WW = Work Week
G = Pb-Free Package

ORDERING INFORMATION

Device	Package	Shipping
BD436	TO-225AA	500 Units/Box
BD436G	TO-225AA (Pb-Free)	500 Units/Box
BD436T	TO-225AA	50 Units/Rail
BD436TG	TO-225AA (Pb-Free)	50 Units/Rail
BD438	TO-225AA	500 Units/Box
BD438G	TO-225AA (Pb-Free)	500 Units/Box
BD440	TO-225AA	500 Units/Box
BD440G	TO-225AA (Pb-Free)	500 Units/Box
BD442	TO-225AA	500 Units/Box
BD442G	TO-225AA (Pb-Free)	500 Units/Box

BD436, BD438, BD440, BD442

ELECTRICAL CHARACTERISTICS ($T_C = 25^\circ\text{C}$ unless otherwise noted)

Characteristic		Symbol	Min	Typ	Max	Unit
Collector–Emitter Breakdown Voltage ($I_C = 100\text{ mA}$, $I_B = 0$)	BD436 BD438 BD440 BD442	$V_{(BR)CEO}$	32 45 60 80	– – – –	– – – –	Vdc
Collector–Base Breakdown Voltage ($I_C = 100\ \mu\text{A}$, $I_B = 0$)	BD436 BD438 BD440 BD442	$V_{(BR)CBO}$	32 45 60 80	– – – –	– – – –	Vdc
Emitter–Base Breakdown Voltage ($I_E = 100\ \mu\text{A}$, $I_C = 0$)		$V_{(BR)EBO}$	5.0	–	–	Vdc
Collector Cutoff Current ($V_{CB} = 32\text{ V}$, $I_E = 0$) ($V_{CB} = 45\text{ V}$, $I_E = 0$) ($V_{CB} = 60\text{ V}$, $I_E = 0$) ($V_{CB} = 80\text{ V}$, $I_E = 0$)	BD436 BD438 BD440 BD442	I_{CBO}	– – – –	– – – –	0.1 0.1 0.1 0.1	mAdc
Emitter Cutoff Current ($V_{EB} = 5.0\text{ V}$)		I_{EBO}	–	–	1.0	mAdc
DC Current Gain ($I_C = 10\text{ mA}$, $V_{CE} = 5.0\text{ V}$)	BD436 BD438 BD440 BD442	h_{FE}	40 30 20 15	– – – –	– – – –	
DC Current Gain ($I_C = 500\text{ mA}$, $V_{CE} = 1.0\text{ V}$)	BD436 BD438 BD440 BD442	h_{FE}	85 85 40 40	– – – –	475 475 475 475	
DC Current Gain ($I_C = 2.0\text{ A}$, $V_{CE} = 1.0\text{ V}$)	BD436 BD438 BD440 BD442	h_{FE}	50 40 25 15	– – – –	– – – –	
Collector Saturation Voltage ($I_C = 2.0\text{ A}$, $I_B = 0.2\text{ A}$) ($I_C = 3.0\text{ A}$, $I_B = 0.3\text{ A}$)	BD436 BD438 BD440 BD442	$V_{CE(sat)}$	– – – –	– – – –	0.5 0.7 0.8 0.8	Vdc
Base–Emitter On Voltage ($I_C = 2.0\text{ A}$, $V_{CE} = 1.0\text{ V}$)	BD436/BD438 BD440/BD442	$V_{BE(ON)}$	– –	– –	1.1 1.5	Vdc
Current–Gain – Bandwidth Product ($V_{CE} = 1.0\text{ V}$, $I_C = 250\text{ mA}$, $f = 1.0\text{ MHz}$)		f_T	3.0	–	–	MHz

BD436, BD438, BD440, BD442

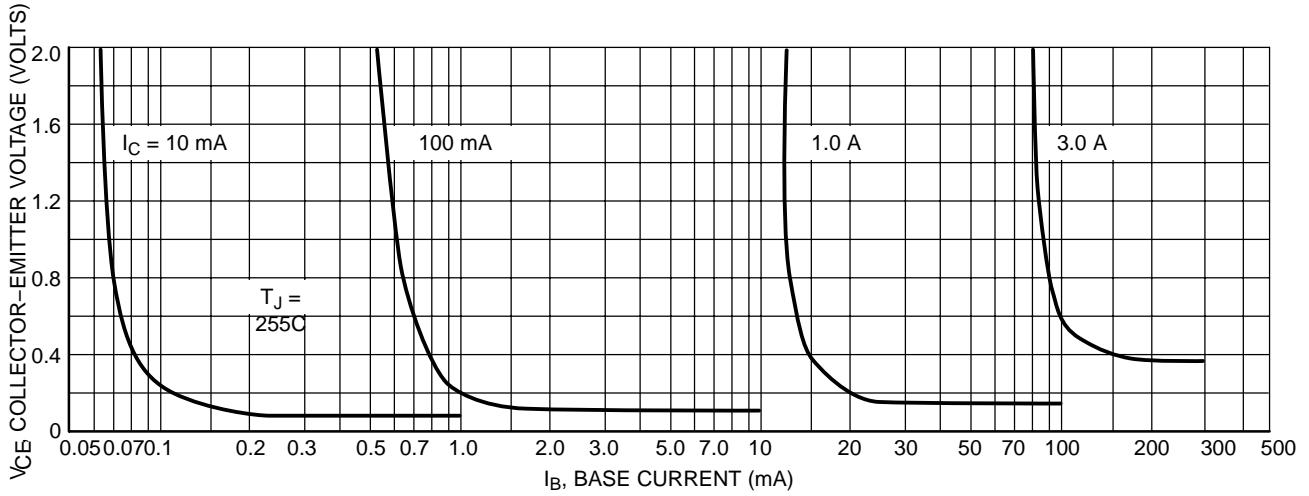

Figure 1. Collector Saturation Region

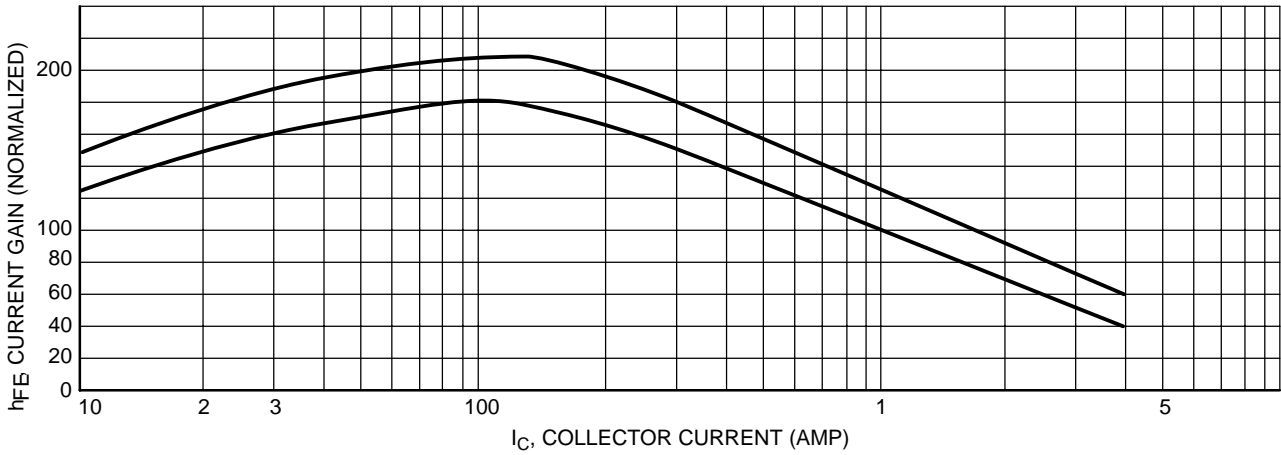

Figure 2. Current Gain

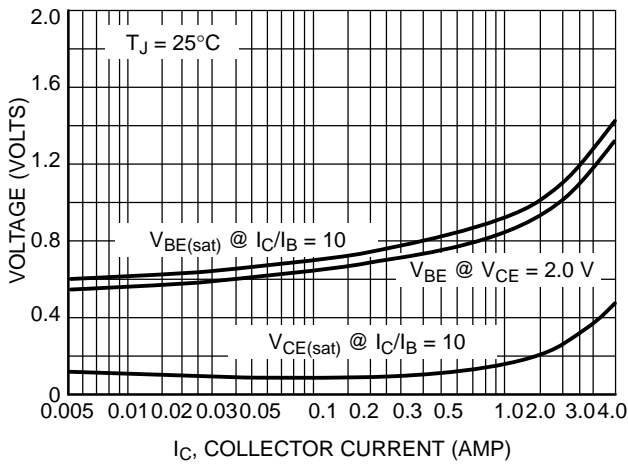

Figure 3. "On" Voltage

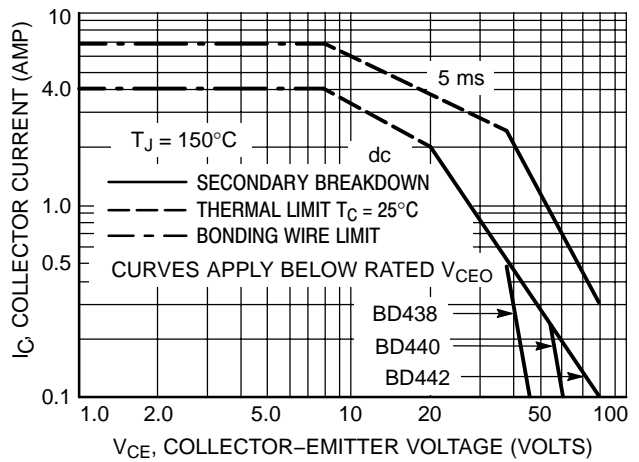
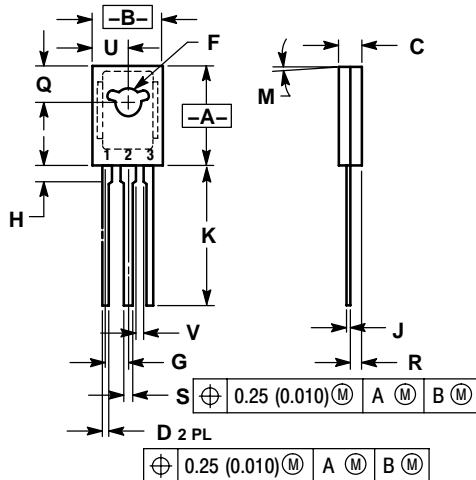

Figure 4. Active Region Safe Operating Area

BD436, BD438, BD440, BD442

PACKAGE DIMENSIONS

TO-225AA
CASE 77-09
ISSUE Z



NOTES:

1. DIMENSIONING AND TOLERANCING PER ANSI Y14.5M, 1982.
2. CONTROLLING DIMENSION: INCH.
3. 077-01 THRU -08 OBSOLETE, NEW STANDARD 077-09.

DIM	INCHES		MILLIMETERS	
	MIN	MAX	MIN	MAX
A	0.425	0.435	10.80	11.04
B	0.295	0.305	7.50	7.74
C	0.095	0.105	2.42	2.66
D	0.020	0.026	0.51	0.66
F	0.115	0.130	2.93	3.30
G	0.094 BSC		2.39 BSC	
H	0.050	0.095	1.27	2.41
J	0.015	0.025	0.39	0.63
K	0.575	0.655	14.61	16.63
M	5° TYP		5° TYP	
Q	0.148	0.158	3.76	4.01
R	0.045	0.065	1.15	1.65
S	0.025	0.035	0.64	0.88
U	0.145	0.155	3.69	3.93
V	0.040	---	1.02	---

STYLE 1:

1. EMITTER
2. COLLECTOR
3. BASE

ON Semiconductor and are registered trademarks of Semiconductor Components Industries, LLC (SCILLC). SCILLC reserves the right to make changes without further notice to any products herein. SCILLC makes no warranty, representation or guarantee regarding the suitability of its products for any particular purpose, nor does SCILLC assume any liability arising out of the application or use of any product or circuit, and specifically disclaims any and all liability, including without limitation special, consequential or incidental damages. "Typical" parameters which may be provided in SCILLC data sheets and/or specifications can and do vary in different applications and actual performance may vary over time. All operating parameters, including "Typicals" must be validated for each customer application by customer's technical experts. SCILLC does not convey any license under its patent rights nor the rights of others. SCILLC products are not designed, intended, or authorized for use as components in systems intended for surgical implant into the body, or other applications intended to support or sustain life, or for any other application in which the failure of the SCILLC product could create a situation where personal injury or death may occur. Should Buyer purchase or use SCILLC products for any such unintended or unauthorized application, Buyer shall indemnify and hold SCILLC and its officers, employees, subsidiaries, affiliates, and distributors harmless against all claims, costs, damages, and expenses, and reasonable attorney fees arising out of, directly or indirectly, any claim of personal injury or death associated with such unintended or unauthorized use, even if such claim alleges that SCILLC was negligent regarding the design or manufacture of the part. SCILLC is an Equal Opportunity/Affirmative Action Employer. This literature is subject to all applicable copyright laws and is not for resale in any manner.

PUBLICATION ORDERING INFORMATION

LITERATURE FULFILLMENT:

Literature Distribution Center for ON Semiconductor
P.O. Box 61312, Phoenix, Arizona 85082-1312 USA
Phone: 480-829-7710 or 800-344-3860 Toll Free USA/Canada
Fax: 480-829-7709 or 800-344-3867 Toll Free USA/Canada
Email: orderlit@onsemi.com

N. American Technical Support: 800-282-9855 Toll Free
USA/Canada

Japan: ON Semiconductor, Japan Customer Focus Center
2-9-1 Kamimeguro, Meguro-ku, Tokyo, Japan 153-0051
Phone: 81-3-5773-3850

ON Semiconductor Website: <http://onsemi.com>

Order Literature: <http://www.onsemi.com/litorder>

For additional information, please contact your local Sales Representative.