

High-accuracy detection voltage
 Low current consumption
VOLTAGE DETECTOR IC
 with adjustable delay time
BD52XXG/FVE series
BD53XXG/FVE series

●Description

BD52XXG/FVE, BD53XXG/FVE are series of high-accuracy detection voltage and low current consumption VOLTAGE DETECTOR ICs adopting CMOS process. New lineup of 152 types with delay time circuit have developed in addition to well-reputed 152 types of VOLTAGE DETECTOR ICs. Any delay time can be established by using small capacitor due to high-resistance process technology. Total 152 types of VOLTAGE DETECTOR ICs including BD52XXG/FVE series (Nch open drain output) and BD53XXG/FVE series (CMOS output), each of which has 38 kinds in every 0.1V step (2.3~6.0V) have developed.

●Features

- 1) Detection voltage: 0.1V step line-up 2.3~6.0V (Typ.)
- 2) High-accuracy detection voltage: $\pm 1.5\%$ (Max.)
- 3) Ultra low current consumption: $0.95\mu\text{A}$ (Typ.)
- 4) Nch open drain output (BD52XXG/FVE series), CMOS output (BD53XXG/FVE series)
- 5) Small VSO5(EMP5), SSOP5(SMP5C2) package

●Applications

Every kind of appliances with microcontroller and logic circuit

●Application Circuit

BD52XXG/FVE

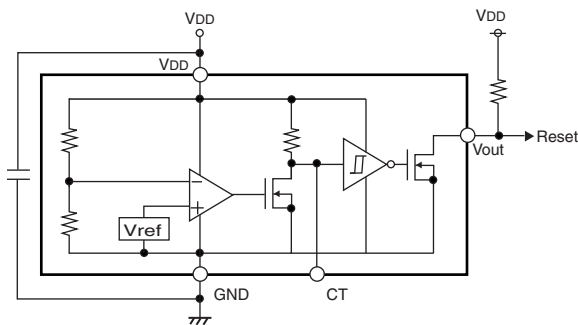

BD53XXG/FVE

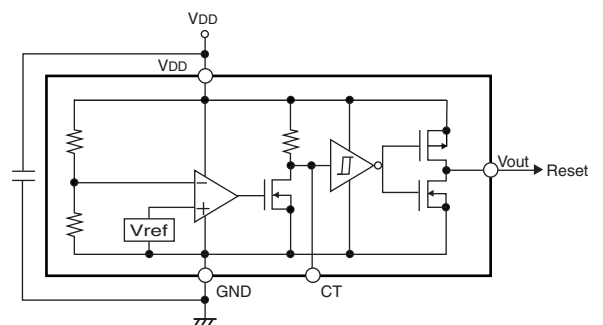

| Pin No. | 1 | 2 | 3 | 4 | 5 |
|---------------|------|-----------------|-----|-----|-----------------|
| SSOP5(SMP5C2) | Vout | V _{DD} | GND | NC. | CT |
| VSO5(EMP5) | Vout | SUB | CT | GND | V _{DD} |

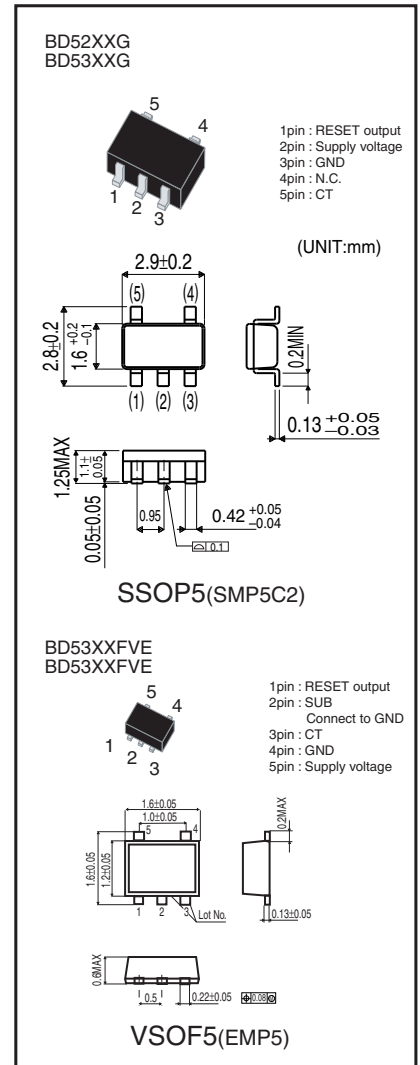

● Absolute Maximum Ratings (Ta=25°C)

| Parameter | Symbol | Limits | Unit |
|------------------------------------|-----------|---|------|
| Power supply voltage | VDD – GND | - 0.3 ~ + 10 | V |
| Output voltage | VOUT | Nch open drain output GND – 0.3 ~ + 10 | V |
| | | CMOS output GND – 0.3 ~ VDD + 0.3 | |
| Input voltage of CT | VCT | GND – 0.3 ~ VDD + 0.3 | V |
| Power dissipation:SSOP5(SMP5C2) *1 | Pd | 540 | mW |
| Power dissipation:VSOF5(EMP5) *2 | Pd | 210 | mW |
| Operating temperature range | Topr | - 40 ~ + 85 | °C |
| Storage temperature range | Tstg | - 55 ~ + 125 | °C |

*1 Derating: 5.4mW/°C for operation above Ta=25°C.(Mounted on a 70.0mmX70.0mmX16mm glass epoxy PCB.)

*2 Derating: 2.1mW/°C for operation above Ta=25°C.(Mounted on a 70.0mmX70.0mmX16mm glass epoxy PCB.)

● Electrical characteristics (Unless otherwise noted; Ta=-25~85°C)

| Parameter | Symbol | Min. | Typ. | Max. | Unit | Conditions | |
|--|---------|----------|----------|---------|--------|----------------------------------|---------------|
| Detection voltage temperature coefficient *1 | VDET/ΔT | — | ±100 | ±360 | ppm/°C | | |
| Hysteresis voltage | ΔVDET | VsX0.03 | VsX0.05 | VsX0.08 | % | RL=470kΩ, VDD=L→H→L | |
| Circuit current when ON | Icc1 | — | 0.80 | 2.40 | μA | VDD=VDET-0.2V | |
| | | — | 0.85 | 2.55 | | | VDET=2.3~3.1V |
| | | — | 0.90 | 2.70 | | | VDET=3.2~4.2V |
| | | — | 0.95 | 2.85 | | | VDET=4.3~5.2V |
| Circuit current when OFF | Icc2 | — | 0.75 | 2.25 | μA | VDD=VDET+2V | |
| | | — | 0.80 | 2.40 | | | VDET=2.3~3.1V |
| | | — | 0.85 | 2.55 | | | VDET=3.2~4.2V |
| | | — | 0.90 | 2.70 | | | VDET=4.3~5.2V |
| Min. operating voltage | VOPL | 0.95 | — | — | V | RL=470kΩ, VOL ≥ 0.4V | |
| "L" output current | IOL | 0.4 | 1.2 | — | mA | VDS=0.5V, VDD=1.2V | |
| | | 2.0 | 5.0 | — | | VDS=0.5V, VDD=2.4V (VDET ≥ 2.7V) | |
| "H" output current | IOH | 0.7 | 1.4 | — | mA | VDS=0.5V, VDD=4.8V VDET=2.3~4.2V | |
| | | 0.9 | 1.8 | — | | VDS=0.5V, VDD=6.0V VDET=4.3~5.2V | |
| | | 1.1 | 2.2 | — | | VDS=0.5V, VDD=8.0V VDET=5.3~6.0V | |
| Output leak current *1 | Ileak | — | — | 0.1 | μA | VDD=VDS=10V | |
| CT pin Threshold voltage | VCTH | VDDX0.3 | VDDX0.4 | VDDX0.6 | V | VDD=VDET X 1.1 | |
| | | VDDX0.3 | VDDX0.45 | VDDX0.6 | | | VDET=2.3~2.6V |
| | | VDDX0.35 | VDDX0.5 | VDDX0.6 | | | VDET=2.7~4.2V |
| | | VDDX0.4 | VDDX0.5 | VDDX0.6 | | | VDET=4.3~5.2V |
| Output delay resistance *1 | RCT | 5.5 | 9 | 12.5 | MΩ | VDD=VDET X 1.1 | |
| CT pin output current *1 | ICT | 15 | 40 | — | μA | VCT=0.1V, VDD=0.95V | |
| | | 150 | 240 | — | | VCT=0.5V, VDD=1.5V | |

*1 This value is guaranteed at Ta=25°C.

*2 TPLH : VDD=(VDET typ.-0.5V) → (VDET typ.+0.5V).

Note) RL is not necessary for CMOS output type.

Note) Please refer to the detection voltage of Line-up table.

● Characteristic diagram and Measurement circuit

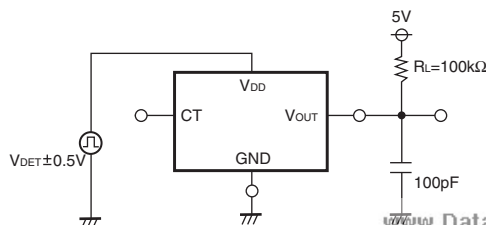
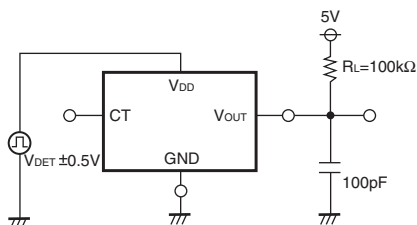
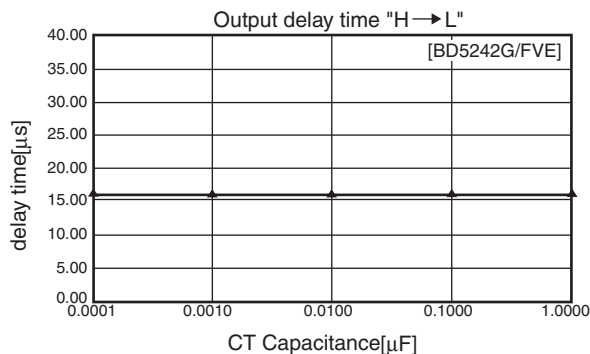
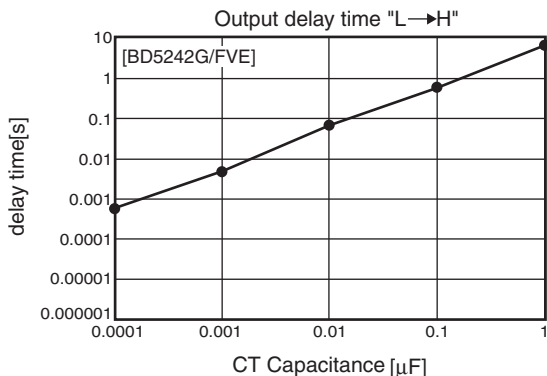

Circuit current

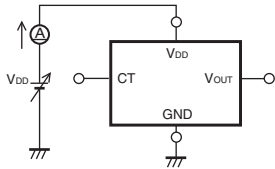
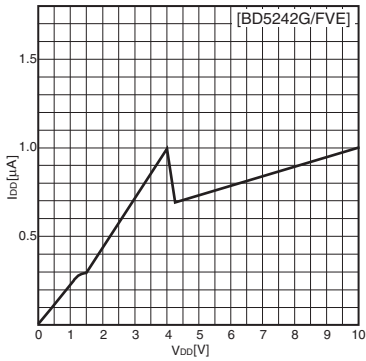

"L" output current

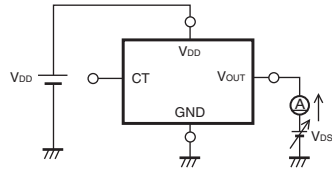
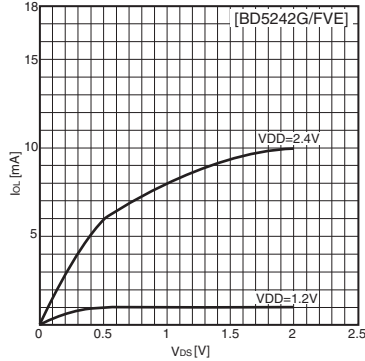

"H" output current

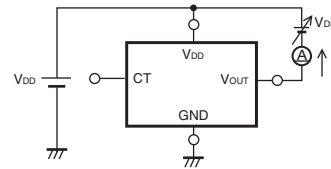
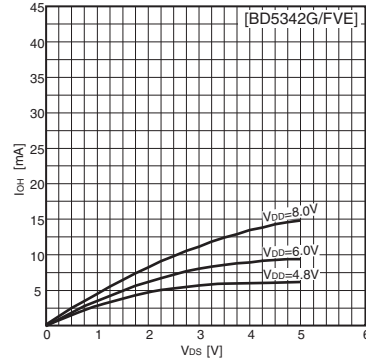

I/O characteristic

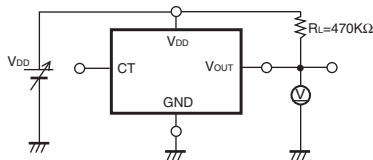
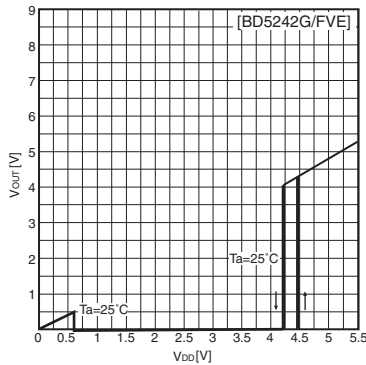

Detection voltage

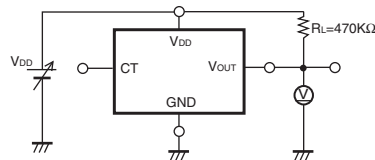
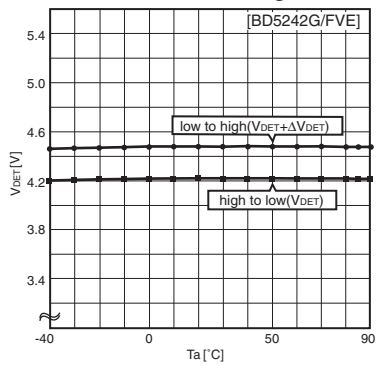

Timing waveform

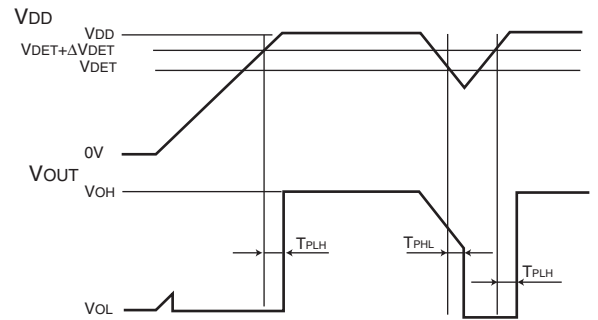

Part number and Marking of samples

| Marking | Voltage | Part No. | Marking | Voltage | Part No. | Marking | Voltage | Part No. | Marking | Voltage | Part No. |
|---------|---------|----------|---------|---------|----------|---------|---------|----------|---------|---------|----------|
| PW | 6.0V | BD5260 | PB | 4.1V | BD5241 | RW | 6.0V | BD5360 | RB | 4.1V | BD5341 |
| PV | 5.9V | BD5259 | PA | 4.0V | BD5240 | RV | 5.9V | BD5359 | RA | 4.0V | BD5340 |
| PU | 5.8V | BD5258 | MV | 3.9V | BD5239 | RU | 5.8V | BD5358 | QV | 3.9V | BD5339 |
| PT | 5.7V | BD5257 | MU | 3.8V | BD5238 | RT | 5.7V | BD5357 | QU | 3.8V | BD5338 |
| PS | 5.6V | BD5256 | MT | 3.7V | BD5237 | RS | 5.6V | BD5356 | QT | 3.7V | BD5337 |
| PR | 5.5V | BD5255 | MS | 3.6V | BD5236 | RR | 5.5V | BD5355 | QS | 3.6V | BD5336 |
| PQ | 5.4V | BD5254 | MR | 3.5V | BD5235 | RQ | 5.4V | BD5354 | QR | 3.5V | BD5335 |
| PP | 5.3V | BD5253 | MQ | 3.4V | BD5234 | RP | 5.3V | BD5353 | QQ | 3.4V | BD5334 |
| PN | 5.2V | BD5252 | MP | 3.3V | BD5233 | RN | 5.2V | BD5352 | QP | 3.3V | BD5333 |
| PM | 5.1V | BD5251 | MN | 3.2V | BD5232 | RM | 5.1V | BD5351 | QN | 3.2V | BD5332 |
| PL | 5.0V | BD5250 | MM | 3.1V | BD5231 | RL | 5.0V | BD5350 | QM | 3.1V | BD5331 |
| PK | 4.9V | BD5249 | ML | 3.0V | BD5230 | RK | 4.9V | BD5349 | QL | 3.0V | BD5330 |
| PJ | 4.8V | BD5248 | MK | 2.9V | BD5229 | RJ | 4.8V | BD5348 | QK | 2.9V | BD5329 |
| PH | 4.7V | BD5247 | MJ | 2.8V | BD5228 | RH | 4.7V | BD5347 | QJ | 2.8V | BD5328 |
| PG | 4.6V | BD5246 | MH | 2.7V | BD5227 | RG | 4.6V | BD5346 | QH | 2.7V | BD5327 |
| PF | 4.5V | BD5245 | MG | 2.6V | BD5226 | RF | 4.5V | BD5345 | QG | 2.6V | BD5326 |
| PE | 4.4V | BD5244 | MF | 2.5V | BD5225 | RE | 4.4V | BD5344 | QF | 2.5V | BD5325 |
| PD | 4.3V | BD5243 | ME | 2.4V | BD5224 | RD | 4.3V | BD5343 | QE | 2.4V | BD5324 |
| PC | 4.2V | BD5242 | MD | 2.3V | BD5223 | RC | 4.2V | BD5342 | QD | 2.3V | BD5323 |

BD52XXG/BD53XXG : SSOP5 (SMP5C2)

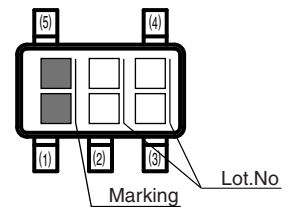

BD52XXFVE/BD53XXFVE : VSOF5 (EMP5)

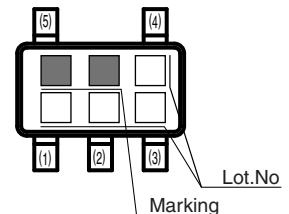

| Detection voltage V _{DET} | Nch open drain output (BD52XXG/FVE) | CMOS output (BD53XXG/FVE) | Detection voltage V _{DET} (V) _{Ta=25° C} | | | Hysteresis voltage (V, Typ.) | Package |
|---------------------------------------|--|--------------------------------|--|-------|-------|--------------------------------------|---------------------------|
| | | | Min. | Typ. | Max. | | |
| 6.0V | BD5260G/FVE | BD5360G/FVE | 5.910 | 6.000 | 6.090 | V _{DET} X 0.05 | SSOP5(SMP5C2)/VSOF5(EMP5) |
| 5.9V | BD5259G/FVE | BD5359G/FVE | 5.812 | 5.900 | 5.989 | | SSOP5(SMP5C2)/VSOF5(EMP5) |
| 5.8V | BD5258G/FVE | BD5358G/FVE | 5.713 | 5.800 | 5.887 | | SSOP5(SMP5C2)/VSOF5(EMP5) |
| 5.7V | BD5257G/FVE | BD5357G/FVE | 5.615 | 5.700 | 5.786 | | SSOP5(SMP5C2)/VSOF5(EMP5) |
| 5.6V | BD5256G/FVE | BD5356G/FVE | 5.516 | 5.600 | 5.684 | | SSOP5(SMP5C2)/VSOF5(EMP5) |
| 5.5V | BD5255G/FVE | BD5355G/FVE | 5.418 | 5.500 | 5.583 | | SSOP5(SMP5C2)/VSOF5(EMP5) |
| 5.4V | BD5254G/FVE | BD5354G/FVE | 5.319 | 5.400 | 5.481 | | SSOP5(SMP5C2)/VSOF5(EMP5) |
| 5.3V | BD5253G/FVE | BD5353G/FVE | 5.221 | 5.300 | 5.380 | | SSOP5(SMP5C2)/VSOF5(EMP5) |
| 5.2V | BD5252G/FVE | BD5352G/FVE | 5.122 | 5.200 | 5.278 | | SSOP5(SMP5C2)/VSOF5(EMP5) |
| 5.1V | BD5251G/FVE | BD5351G/FVE | 5.024 | 5.100 | 5.177 | | SSOP5(SMP5C2)/VSOF5(EMP5) |
| 5.0V | BD5250G/FVE | BD5350G/FVE | 4.925 | 5.000 | 5.075 | | SSOP5(SMP5C2)/VSOF5(EMP5) |
| 4.9V | BD5249G/FVE | BD5349G/FVE | 4.827 | 4.900 | 4.974 | | SSOP5(SMP5C2)/VSOF5(EMP5) |
| 4.8V | BD5248G/FVE | BD5348G/FVE | 4.728 | 4.800 | 4.872 | | SSOP5(SMP5C2)/VSOF5(EMP5) |
| 4.7V | BD5247G/FVE | BD5347G/FVE | 4.630 | 4.700 | 4.771 | | SSOP5(SMP5C2)/VSOF5(EMP5) |
| 4.6V | BD5246G/FVE | BD5346G/FVE | 4.531 | 4.600 | 4.669 | | SSOP5(SMP5C2)/VSOF5(EMP5) |
| 4.5V | BD5245G/FVE | BD5345G/FVE | 4.433 | 4.500 | 4.568 | | SSOP5(SMP5C2)/VSOF5(EMP5) |
| 4.4V | BD5244G/FVE | BD5344G/FVE | 4.334 | 4.400 | 4.466 | | SSOP5(SMP5C2)/VSOF5(EMP5) |
| 4.3V | BD5243G/FVE | BD5343G/FVE | 4.236 | 4.300 | 4.365 | | SSOP5(SMP5C2)/VSOF5(EMP5) |
| 4.2V | BD5242G/FVE | BD5342G/FVE | 4.137 | 4.200 | 4.263 | | SSOP5(SMP5C2)/VSOF5(EMP5) |
| 4.1V | BD5241G/FVE | BD5341G/FVE | 4.039 | 4.100 | 4.162 | | SSOP5(SMP5C2)/VSOF5(EMP5) |
| 4.0V | BD5240G/FVE | BD5340G/FVE | 3.940 | 4.000 | 4.060 | | SSOP5(SMP5C2)/VSOF5(EMP5) |
| 3.9V | BD5239G/FVE | BD5339G/FVE | 3.842 | 3.900 | 3.959 | | SSOP5(SMP5C2)/VSOF5(EMP5) |
| 3.8V | BD5238G/FVE | BD5338G/FVE | 3.743 | 3.800 | 3.857 | | SSOP5(SMP5C2)/VSOF5(EMP5) |
| 3.7V | BD5237G/FVE | BD5337G/FVE | 3.645 | 3.700 | 3.756 | | SSOP5(SMP5C2)/VSOF5(EMP5) |
| 3.6V | BD5236G/FVE | BD5336G/FVE | 3.546 | 3.600 | 3.654 | | SSOP5(SMP5C2)/VSOF5(EMP5) |
| 3.5V | BD5235G/FVE | BD5335G/FVE | 3.448 | 3.500 | 3.553 | | SSOP5(SMP5C2)/VSOF5(EMP5) |
| 3.4V | BD5234G/FVE | BD5334G/FVE | 3.349 | 3.400 | 3.451 | | SSOP5(SMP5C2)/VSOF5(EMP5) |
| 3.3V | BD5233G/FVE | BD5333G/FVE | 3.251 | 3.300 | 3.350 | | SSOP5(SMP5C2)/VSOF5(EMP5) |
| 3.2V | BD5232G/FVE | BD5332G/FVE | 3.152 | 3.200 | 3.248 | | SSOP5(SMP5C2)/VSOF5(EMP5) |
| 3.1V | BD5231G/FVE | BD5331G/FVE | 3.054 | 3.100 | 3.147 | | SSOP5(SMP5C2)/VSOF5(EMP5) |
| 3.0V | BD5230G/FVE | BD5330G/FVE | 2.955 | 3.000 | 3.045 | SSOP5(SMP5C2)/VSOF5(EMP5) | |
| 2.9V | BD5229G/FVE | BD5329G/FVE | 2.857 | 2.900 | 2.944 | SSOP5(SMP5C2)/VSOF5(EMP5) | |
| 2.8V | BD5228G/FVE | BD5328G/FVE | 2.758 | 2.800 | 2.842 | SSOP5(SMP5C2)/VSOF5(EMP5) | |
| 2.7V | BD5227G/FVE | BD5327G/FVE | 2.660 | 2.700 | 2.741 | SSOP5(SMP5C2)/VSOF5(EMP5) | |
| 2.6V | BD5226G/FVE | BD5326G/FVE | 2.561 | 2.600 | 2.639 | SSOP5(SMP5C2)/VSOF5(EMP5) | |
| 2.5V | BD5225G/FVE | BD5325G/FVE | 2.463 | 2.500 | 2.538 | SSOP5(SMP5C2)/VSOF5(EMP5) | |
| 2.4V | BD5224G/FVE | BD5324G/FVE | 2.364 | 2.400 | 2.436 | SSOP5(SMP5C2)/VSOF5(EMP5) | |
| 2.3V | BD5223G/FVE | BD5323G/FVE | 2.266 | 2.300 | 2.335 | SSOP5(SMP5C2)/VSOF5(EMP5) | |