

High-accuracy detection voltage
 Low current consumption
VOLTAGE DETECTOR IC
 with adjustable delay time
BD52XXG/FVE series
BD53XXG/FVE series

● Description

BD52XXG/FVE, BD53XXG/FVE are series of high-accuracy detection voltage and low current consumption VOLTAGE DETECTOR ICs adopting CMOS process. New lineup of 152 types with delay time circuit have developed in addition to well-reputed 152 types of VOLTAGE DETECTOR ICs. Any delay time can be established by using small capacitor due to high-resistance process technology. Total 152 types of VOLTAGE DETECTOR ICs including BD52XXG/FVE series (Nch open drain output) and BD53XXG/FVE series (CMOS output), each of which has 38 kinds in every 0.1V step (2.3~6.0V) have developed.

● Features

- 1) Detection voltage: 0.1V step line-up 2.3~6.0V (Typ.)
- 2) High-accuracy detection voltage: $\pm 1.5\%$ (Max.)
- 3) Ultra low current consumption: $0.95\mu\text{A}$ (Typ.)
- 4) Nch open drain output (BD52XXG/FVE series), CMOS output (BD53XXG/FVE series)
- 5) Small VSO5(EMP5), SSOP5(SMP5C2) package

● Applications

Every kind of appliances with microcontroller and logic circuit

● Application Circuit

BD52XXG/FVE

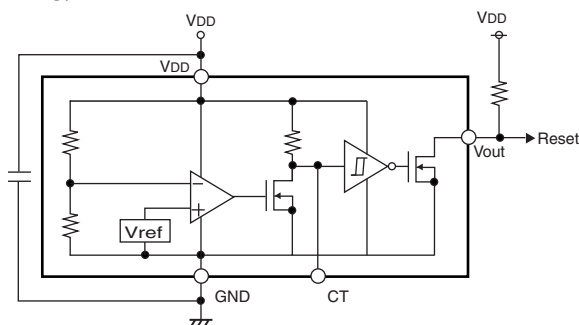

BD53XXG/FVE

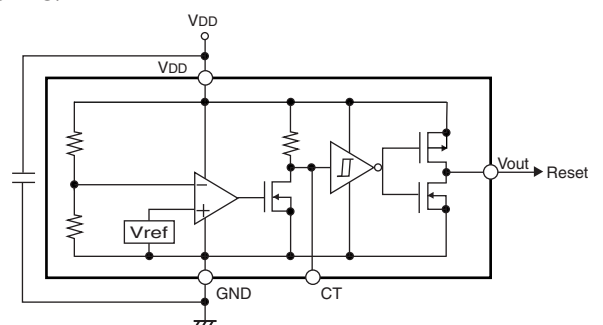

Pin No.	1	2	3	4	5
SSOP5(SMP5C2)	Vout	V _{DD}	GND	NC.	CT
VSO5(EMP5)	Vout	SUB	CT	GND	V _{DD}

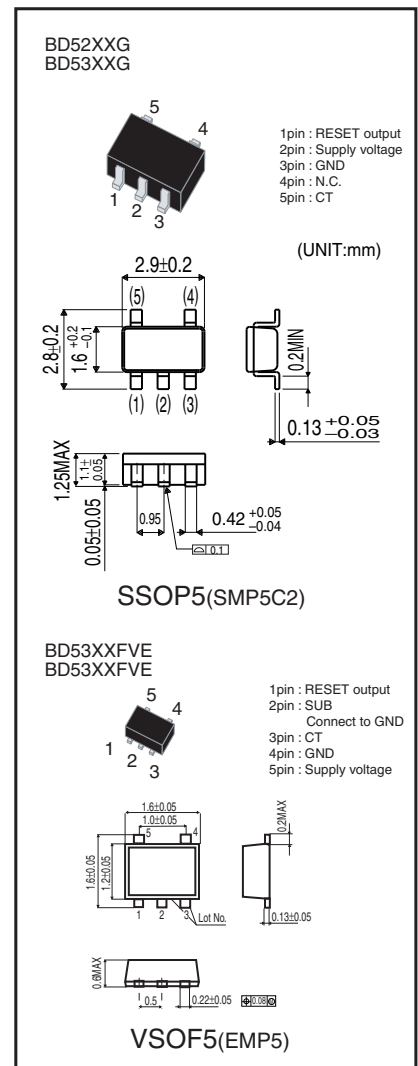

● Absolute Maximum Ratings (Ta=25°C)

Parameter	Symbol	Limits	Unit
Power supply voltage	VDD – GND	- 0.3 ~ + 10	V
Output voltage	VOUT	GND – 0.3 ~ + 10	V
		GND – 0.3 ~ VDD + 0.3	
Input voltage of CT	VCT	GND – 0.3 ~ VDD + 0.3	V
Power dissipation:SSOP5(SMP5C2) *1	Pd	540	mW
Power dissipation:VSOF5(EMP5) *2	Pd	210	mW
Operating temperature range	Topr	- 40 ~ + 85	°C
Storage temperature range	Tstg	- 55 ~ + 125	°C

*1 Derating: 5.4mW/°C for operation above Ta=25°C.(Mounted on a 70.0mmX70.0mmX16mm glass epoxy PCB.)

*2 Derating: 2.1mW/°C for operation above Ta=25°C.(Mounted on a 70.0mmX70.0mmX16mm glass epoxy PCB.)

● Electrical characteristics (Unless otherwise noted; Ta=-25~85°C)

Parameter	Symbol	Min.	Typ.	Max.	Unit	Conditions
Detection voltage temperature coefficient *1	VDET/ΔT	—	±100	±360	ppm/°C	
Hysteresis voltage	ΔVDET	VsX0.03	VsX0.05	VsX0.08	%	RL=470kΩ, VDD=L→H→L
Circuit current when ON	Icc1	—	0.80	2.40	μA	VDD=VDET-0.2V
		—	0.85	2.55		
		—	0.90	2.70		
		—	0.95	2.85		
Circuit current when OFF	Icc2	—	0.75	2.25	μA	VDD=VDET+2V
		—	0.80	2.40		
		—	0.85	2.55		
		—	0.90	2.70		
Min. operating voltage	VOPL	0.95	—	—	V	RL=470kΩ, VOL ≥ 0.4V
"L" output current	IOL	0.4	1.2	—	mA	VDS=0.5V, VDD=1.2V
		2.0	5.0	—		VDS=0.5V, VDD=2.4V (VDET ≥ 2.7V)
"H" output current	IOH	0.7	1.4	—	mA	VDS=0.5V, VDD=4.8V VDET=2.3~4.2V
		0.9	1.8	—		VDS=0.5V, VDD=6.0V VDET=4.3~5.2V
		1.1	2.2	—		VDS=0.5V, VDD=8.0V VDET=5.3~6.0V
Output leak current *1	Ileak	—	—	0.1	μA	VDD=VDS=10V
CT pin Threshold voltage	VCTH	VDDX0.3	VDDX0.4	VDDX0.6	V	VDD=VDET X 1.1
		VDDX0.3	VDDX0.45	VDDX0.6		
		VDDX0.35	VDDX0.5	VDDX0.6		
		VDDX0.4	VDDX0.5	VDDX0.6		
Output delay resistance *1	RCT	5.5	9	12.5	MΩ	VDD=VDET X 1.1
CT pin output current *1	ICT	15	40	—	μA	VCT=0.1V, VDD=0.95V
		150	240	—		VCT=0.5V, VDD=1.5V

*1 This value is guaranteed at Ta=25°C.

*2 TPLH : VDD=(VDET typ.-0.5V) → (VDET typ.+0.5V).

Note) RL is not necessary for CMOS output type.

Note) Please refer to the detection voltage of Line-up table.

● Characteristic diagram and Measurement circuit

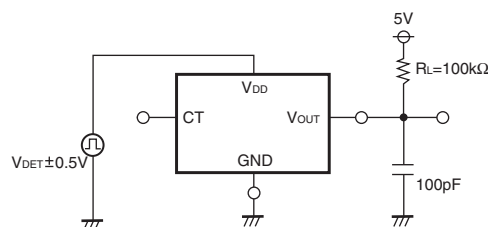
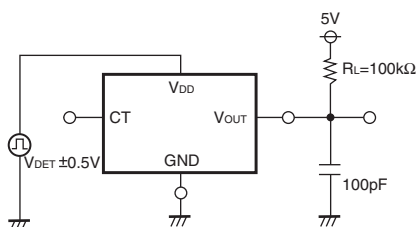
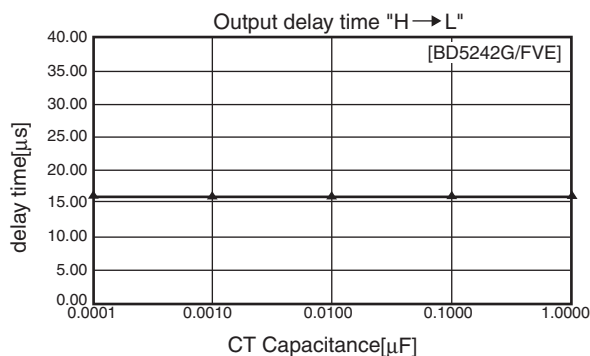
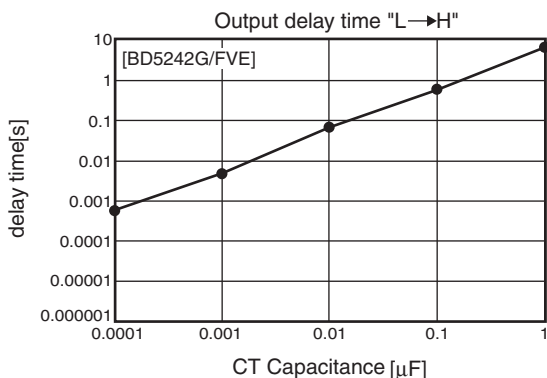

Circuit current

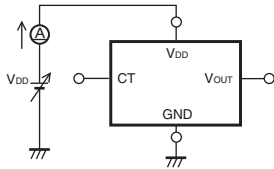
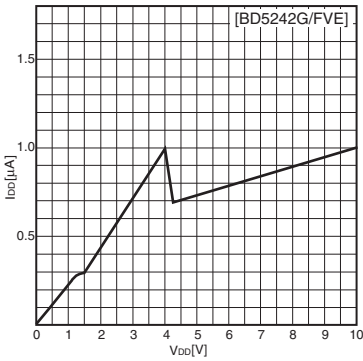

"L" output current

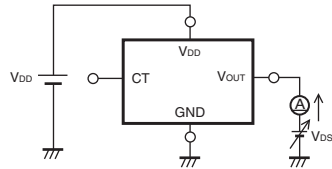
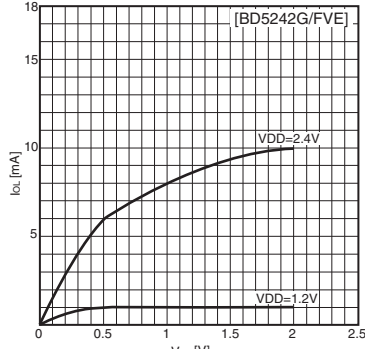

"H" output current

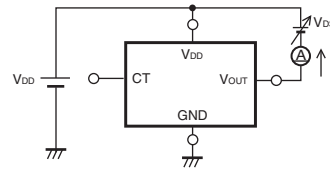
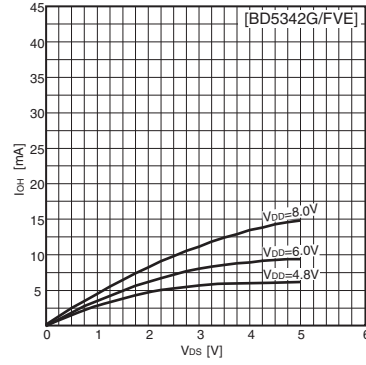

I/O characteristic

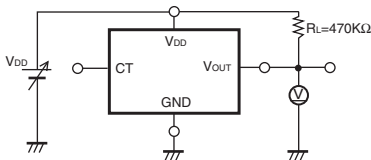
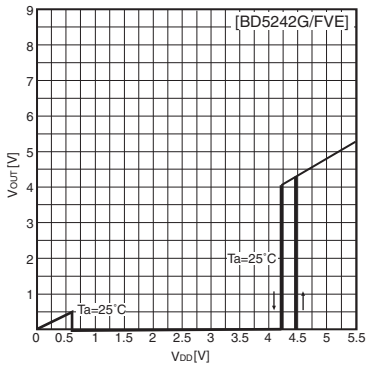

Detection voltage

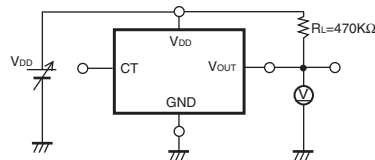
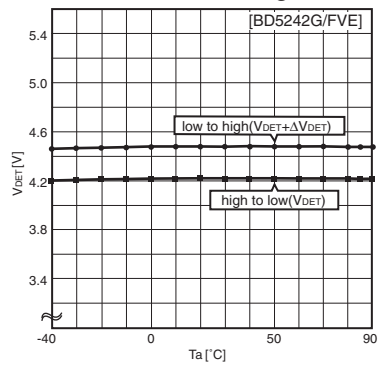

● Timing waveform

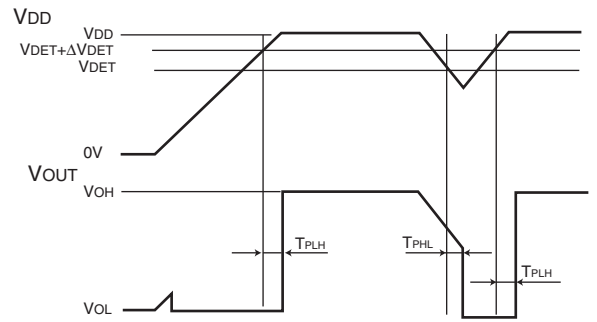

● Part number and Marking of samples

Marking	Voltage	Part No.	Marking	Voltage	Part No.	Marking	Voltage	Part No.	Marking	Voltage	Part No.
PW	6.0V	BD5260	PB	4.1V	BD5241	RW	6.0V	BD5360	RB	4.1V	BD5341
PV	5.9V	BD5259	PA	4.0V	BD5240	RV	5.9V	BD5359	RA	4.0V	BD5340
PU	5.8V	BD5258	MV	3.9V	BD5239	RU	5.8V	BD5358	QV	3.9V	BD5339
PT	5.7V	BD5257	MU	3.8V	BD5238	RT	5.7V	BD5357	QU	3.8V	BD5338
PS	5.6V	BD5256	MT	3.7V	BD5237	RS	5.6V	BD5356	QT	3.7V	BD5337
PR	5.5V	BD5255	MS	3.6V	BD5236	RR	5.5V	BD5355	QS	3.6V	BD5336
PQ	5.4V	BD5254	MR	3.5V	BD5235	RQ	5.4V	BD5354	QR	3.5V	BD5335
PP	5.3V	BD5253	MQ	3.4V	BD5234	RP	5.3V	BD5353	QQ	3.4V	BD5334
PN	5.2V	BD5252	MP	3.3V	BD5233	RN	5.2V	BD5352	QP	3.3V	BD5333
PM	5.1V	BD5251	MN	3.2V	BD5232	RM	5.1V	BD5351	QN	3.2V	BD5332
PL	5.0V	BD5250	MM	3.1V	BD5231	RL	5.0V	BD5350	QM	3.1V	BD5331
PK	4.9V	BD5249	ML	3.0V	BD5230	RK	4.9V	BD5349	QL	3.0V	BD5330
PJ	4.8V	BD5248	MK	2.9V	BD5229	RJ	4.8V	BD5348	QK	2.9V	BD5329
PH	4.7V	BD5247	MJ	2.8V	BD5228	RH	4.7V	BD5347	QJ	2.8V	BD5328
PG	4.6V	BD5246	MH	2.7V	BD5227	RG	4.6V	BD5346	QH	2.7V	BD5327
PF	4.5V	BD5245	MG	2.6V	BD5226	RF	4.5V	BD5345	QG	2.6V	BD5326
PE	4.4V	BD5244	MF	2.5V	BD5225	RE	4.4V	BD5344	QF	2.5V	BD5325
PD	4.3V	BD5243	ME	2.4V	BD5224	RD	4.3V	BD5343	QE	2.4V	BD5324
PC	4.2V	BD5242	MD	2.3V	BD5223	RC	4.2V	BD5342	QD	2.3V	BD5323

BD52XXG/BD53XXG : SSOP5 (SMP5C2)

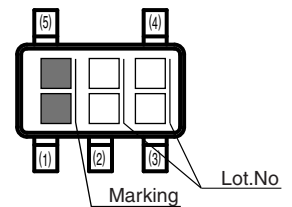

BD52XXFVE/BD53XXFVE : VSOF5 (EMP5)

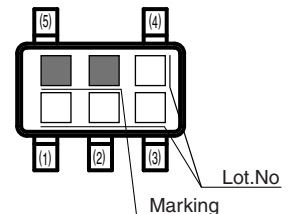

●Line-up

Detection voltage V _{DET}	Nch open drain output (BD52XXG/FVE)	CMOS output (BD53XXG/FVE)	Detection voltage V _{DET} (V)Ta=25° C			Hysteresis voltage (V, Typ.)	Package
			Min.	Typ.	Max.		
6.0V	BD5260G/FVE	BD5360G/FVE	5.910	6.000	6.090	V _{DET} X 0.05	SSOP5(SMP5C2)/VSOF5(EMP5)
5.9V	BD5259G/FVE	BD5359G/FVE	5.812	5.900	5.989		SSOP5(SMP5C2)/VSOF5(EMP5)
5.8V	BD5258G/FVE	BD5358G/FVE	5.713	5.800	5.887		SSOP5(SMP5C2)/VSOF5(EMP5)
5.7V	BD5257G/FVE	BD5357G/FVE	5.615	5.700	5.786		SSOP5(SMP5C2)/VSOF5(EMP5)
5.6V	BD5256G/FVE	BD5356G/FVE	5.516	5.600	5.684		SSOP5(SMP5C2)/VSOF5(EMP5)
5.5V	BD5255G/FVE	BD5355G/FVE	5.418	5.500	5.583		SSOP5(SMP5C2)/VSOF5(EMP5)
5.4V	BD5254G/FVE	BD5354G/FVE	5.319	5.400	5.481		SSOP5(SMP5C2)/VSOF5(EMP5)
5.3V	BD5253G/FVE	BD5353G/FVE	5.221	5.300	5.380		SSOP5(SMP5C2)/VSOF5(EMP5)
5.2V	BD5252G/FVE	BD5352G/FVE	5.122	5.200	5.278		SSOP5(SMP5C2)/VSOF5(EMP5)
5.1V	BD5251G/FVE	BD5351G/FVE	5.024	5.100	5.177		SSOP5(SMP5C2)/VSOF5(EMP5)
5.0V	BD5250G/FVE	BD5350G/FVE	4.925	5.000	5.075		SSOP5(SMP5C2)/VSOF5(EMP5)
4.9V	BD5249G/FVE	BD5349G/FVE	4.827	4.900	4.974		SSOP5(SMP5C2)/VSOF5(EMP5)
4.8V	BD5248G/FVE	BD5348G/FVE	4.728	4.800	4.872		SSOP5(SMP5C2)/VSOF5(EMP5)
4.7V	BD5247G/FVE	BD5347G/FVE	4.630	4.700	4.771		SSOP5(SMP5C2)/VSOF5(EMP5)
4.6V	BD5246G/FVE	BD5346G/FVE	4.531	4.600	4.669		SSOP5(SMP5C2)/VSOF5(EMP5)
4.5V	BD5245G/FVE	BD5345G/FVE	4.433	4.500	4.568		SSOP5(SMP5C2)/VSOF5(EMP5)
4.4V	BD5244G/FVE	BD5344G/FVE	4.334	4.400	4.466		SSOP5(SMP5C2)/VSOF5(EMP5)
4.3V	BD5243G/FVE	BD5343G/FVE	4.236	4.300	4.365		SSOP5(SMP5C2)/VSOF5(EMP5)
4.2V	BD5242G/FVE	BD5342G/FVE	4.137	4.200	4.263		SSOP5(SMP5C2)/VSOF5(EMP5)
4.1V	BD5241G/FVE	BD5341G/FVE	4.039	4.100	4.162		SSOP5(SMP5C2)/VSOF5(EMP5)
4.0V	BD5240G/FVE	BD5340G/FVE	3.940	4.000	4.060		SSOP5(SMP5C2)/VSOF5(EMP5)
3.9V	BD5239G/FVE	BD5339G/FVE	3.842	3.900	3.959		SSOP5(SMP5C2)/VSOF5(EMP5)
3.8V	BD5238G/FVE	BD5338G/FVE	3.743	3.800	3.857		SSOP5(SMP5C2)/VSOF5(EMP5)
3.7V	BD5237G/FVE	BD5337G/FVE	3.645	3.700	3.756		SSOP5(SMP5C2)/VSOF5(EMP5)
3.6V	BD5236G/FVE	BD5336G/FVE	3.546	3.600	3.654		SSOP5(SMP5C2)/VSOF5(EMP5)
3.5V	BD5235G/FVE	BD5335G/FVE	3.448	3.500	3.553		SSOP5(SMP5C2)/VSOF5(EMP5)
3.4V	BD5234G/FVE	BD5334G/FVE	3.349	3.400	3.451		SSOP5(SMP5C2)/VSOF5(EMP5)
3.3V	BD5233G/FVE	BD5333G/FVE	3.251	3.300	3.350		SSOP5(SMP5C2)/VSOF5(EMP5)
3.2V	BD5232G/FVE	BD5332G/FVE	3.152	3.200	3.248		SSOP5(SMP5C2)/VSOF5(EMP5)
3.1V	BD5231G/FVE	BD5331G/FVE	3.054	3.100	3.147		SSOP5(SMP5C2)/VSOF5(EMP5)
3.0V	BD5230G/FVE	BD5330G/FVE	2.955	3.000	3.045	SSOP5(SMP5C2)/VSOF5(EMP5)	
2.9V	BD5229G/FVE	BD5329G/FVE	2.857	2.900	2.944	SSOP5(SMP5C2)/VSOF5(EMP5)	
2.8V	BD5228G/FVE	BD5328G/FVE	2.758	2.800	2.842	SSOP5(SMP5C2)/VSOF5(EMP5)	
2.7V	BD5227G/FVE	BD5327G/FVE	2.660	2.700	2.741	SSOP5(SMP5C2)/VSOF5(EMP5)	
2.6V	BD5226G/FVE	BD5326G/FVE	2.561	2.600	2.639	SSOP5(SMP5C2)/VSOF5(EMP5)	
2.5V	BD5225G/FVE	BD5325G/FVE	2.463	2.500	2.538	SSOP5(SMP5C2)/VSOF5(EMP5)	
2.4V	BD5224G/FVE	BD5324G/FVE	2.364	2.400	2.436	SSOP5(SMP5C2)/VSOF5(EMP5)	
2.3V	BD5223G/FVE	BD5323G/FVE	2.266	2.300	2.335	SSOP5(SMP5C2)/VSOF5(EMP5)	