

0221555

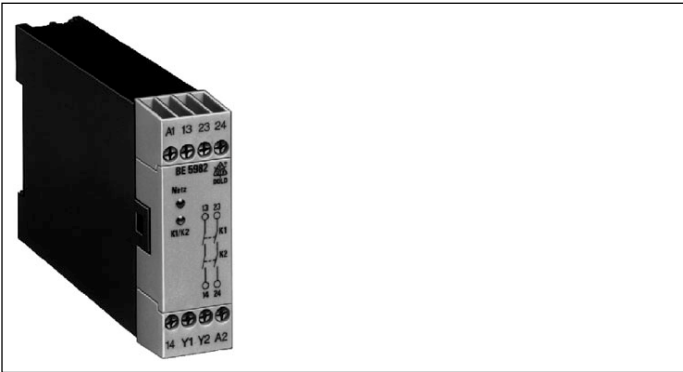

- According to EU Directive for machines 98/37/EG
- According to EN 60 204-1, DIN VDE 0113 part 1 (11.98)
- Safety category 4 according to DIN EN 954-1
- Output: 2 NO contacts for AC 250 V
- Single-channel emergency stop circuit
- LED indication for channels 1 / 2 and operating state
- Short circuit protection
- Wire connection: also 2 x 1,5 mm² stranded ferruled (isolated), DIN 46 228-4 or 2 x 2,5 mm² stranded ferruled DIN 46 228-1/-2/-3
- Width 22,5 mm

Function diagram

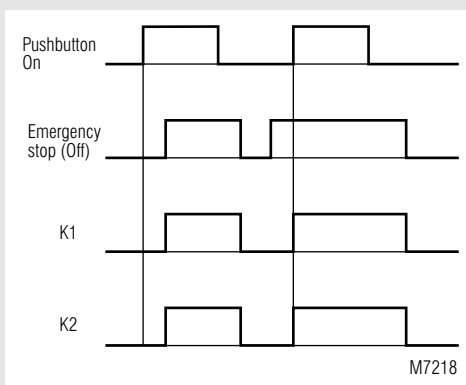

Block diagram

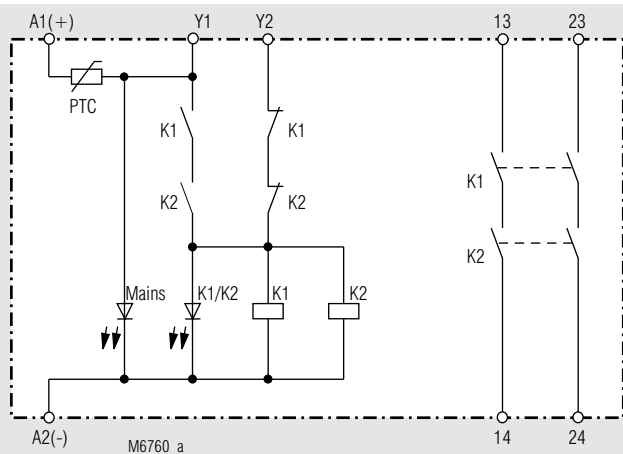

Circuit diagram

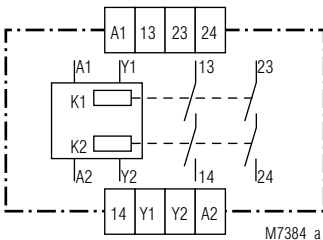

Approvals and marking



Application

- Protection of persons and machines
- Emergency stop circuits on machines

Indication

LED power supply: on when operating voltage present
LED K1/K2: on when output relays K1, K2 are energized

Notes

When using the E-stop module with "automatic start" mode, the automatic restart (according to EN 60 204-1 part 9.2.5.4.2 and 10.8.3) has to be inhibited by the machine control.

Technical data

Input

Nominal voltage U_N : DC 24 V
Voltage range
 at 10 % residual ripple: DC 0,9 ... 1,1 U_N
 at 48 % residual ripple: DC 0,8 ... 1,1 U_N
Nominal consumption: approx. 1,6 W
Control voltage Y1: DC 24 V
Control current: typ. DC 45 mA
Recovery time: 0,5 s

Output

Contacts

BE 5982.02: 2 NO contacts
Response time: max. 100 ms
Release time: max. 35 ms
Contact type: Relay, positively driven
Output rated voltage: AC 250 V
Thermal current I_{th} : see continuous limit curve (max. 6 A in one contact path)

Switching capacity

to AC 15: 5 A / AC 230 V EN 60 947-5-1
 for NO contact
 2 A / AC 230 V EN 60 947-5-1
 for NC contact

Electrical life

to AC 15 at 2 A, AC 230 V: 10⁵ switching cycles EN 60 947-5-1

Permissible switching frequency:

600 switching cycles / h

Short circuit strength

max. fuse rating: 4 A gL EN 60 947-5-1

Mechanical life:

10 x 10⁶ switching cycles

Technical data

General data

Operating mode:	Continuous operation	
Temperature range:	- 15 ... + 55 °C	
Clearance and creepage distances		
overvoltage category / contamination level:	4 kV / 2	IEC 60 664-1
EMC		
Electrostatic discharge:	8 kV (air)	EN 61 000-4-2
HF irradiation:	10 V / m	EN 61 000-4-3
Fast transients:	4 kV	EN 61 000-4-4
Surge voltages between wires for power supply:	1 kV	EN 61 000-4-5
between wire and ground:	2 kV	EN 61 000-4-5
Interference suppression:	Limit value class B	EN 55 011
Degree of protection:	Housing: IP 40	EN 60 529
	Terminals: IP 20	EN 60 529
Housing:	Thermoplastic with V0 behaviour according to UL subject 94	
Vibration resistance:	Amplitude 0,35 mm frequency 10 ... 55 Hz, EN 60 068-2-6	
Climate resistance:	15 / 055 / 04 EN 60 068-1	
Terminal designation:	EN 50 005	
Wire connection:	1 x 4 mm ² solid or 1 x 2,5 mm ² stranded ferruled (isolated) or 2 x 1,5 mm ² stranded ferruled (isolated) DIN 46 228-1/-2/-3/-4 or 2 x 2,5 mm ² stranded ferruled DIN 46 228-1/-2/-3	
Wire fixing:	Plus-minus terminal screws M3.5, box terminal with wire protection	
Mounting:	DIN rail	EN 50 022
Weight:	170 g	

Dimensions

Width x height x depth: 22,5 x 74 x 121 mm

Standard type

BE 5982.02 DC 24 V		
Article number:	0044292	stock item
• Output:	2 NO contacts	
• Nominal voltage U_N :	DC 24 V	
• Width:	22,5 mm	

Characteristics

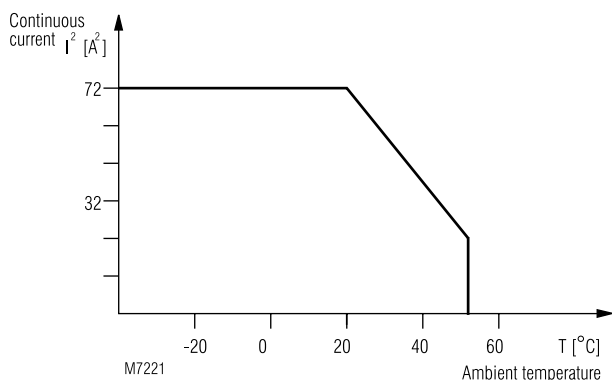

Continuous current limit curve

Application examples

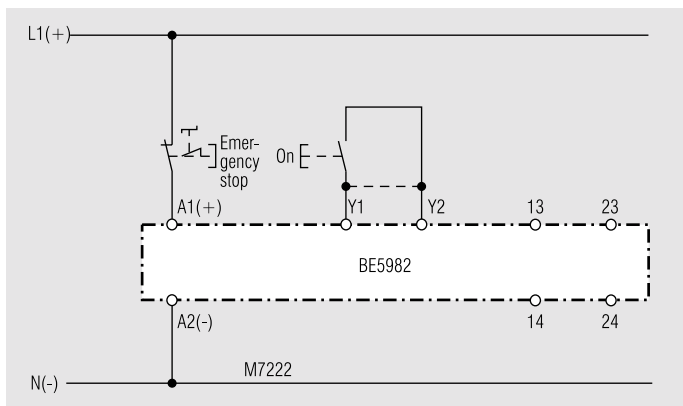

Single-channel emergency stop circuit, optionally with or without automatic On function. Set jumper Y1 - Y2 for automatic On function. The On button is omitted.

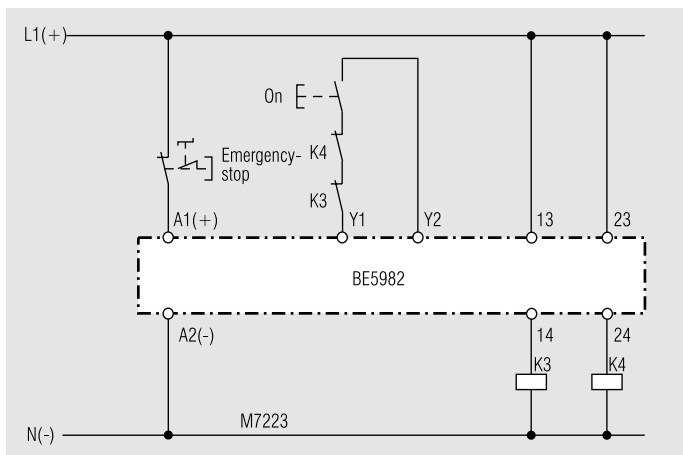

Contact reinforcement by external contactors. With switching currents > 5 A, the output contacts can be reinforced by external contactors with positively-driven contacts. The function of the external contactors is monitored by looping the NC contacts into the switch-on circuit (terminals Y1 - Y2).

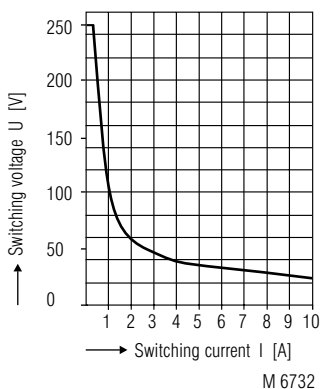

Limit curve for arc-free operation for a resistive load