

# BF1208D

## Dual N-channel dual gate MOSFET

Rev. 01 — 16 May 2007

Product data sheet

## 1. Product profile

### 1.1 General description

The BF1208D is a combination of two dual gate MOSFET amplifiers with shared source and gate2 leads and an integrated switch. The integrated switch is operated by the gate1 bias of amplifier B.

The source and substrate are interconnected. Internal bias circuits enable DC stabilization and a very good cross modulation performance during Automatic Gain Control (AGC). Integrated diodes between the gates and source protect against excessive input voltage surges. The transistor has a SOT666 micro-miniature plastic package.

#### CAUTION



This device is sensitive to ElectroStatic Discharge (ESD). Therefore care should be taken during transport and handling.

### 1.2 Features

- Two low noise gain controlled amplifiers in a single package. One with a fully integrated bias and one with a partly integrated bias
- Internal switch to save external components
- Superior cross modulation performance during AGC
- High forward transfer admittance
- High forward transfer admittance to input capacitance ratio

### 1.3 Applications

- Gain controlled low noise amplifiers for VHF and UHF applications with 5 V supply voltage
  - ◆ digital and analog television tuners
  - ◆ professional communication equipment

## 1.4 Quick reference data

**Table 1. Quick reference data**

Per MOSFET unless otherwise specified.

Symbol	Parameter	Conditions	Min	Typ	Max	Unit
$V_{DS}$	drain-source voltage	DC	-	-	6	V
$I_D$	drain current	DC	-	-	30	mA
$P_{tot}$	total power dissipation	$T_{sp} \leq 109\text{ }^\circ\text{C}$	[1]	-	180	mW
$ Y_{fs} $	forward transfer admittance	$f = 100\text{ MHz}; T_j = 25\text{ }^\circ\text{C}$				
		amplifier A; $I_D = 19\text{ mA}$	26	31	41	mS
		amplifier B; $I_D = 15\text{ mA}$	25	30	40	mS
$C_{iss(G1)}$	input capacitance at gate1	$f = 100\text{ MHz}$				
		amplifier A	[2]	-	2.1	2.6 pF
		amplifier B	[2]	-	2.1	2.6 pF
$C_{rss}$	reverse transfer capacitance	$f = 100\text{ MHz}$	[2]	-	30	fF
NF	noise figure	$Y_S = Y_{S(opt)}$				
		amplifier A; $f = 400\text{ MHz}$	-	0.9	1.5	dB
		amplifier B; $f = 800\text{ MHz}$	-	1.4	2.0	dB
Xmod	cross modulation	input level for $k = 1\%$ ; $f_w = 50\text{ MHz}$ ; $f_{unw} = 60\text{ MHz}$ at 40 dB AGC				
		amplifier A	[3]	102	105	- dB $\mu$ V
		amplifier B	[4]	102	105	- dB $\mu$ V
$T_j$	junction temperature		-	-	150	$^\circ\text{C}$

 [1]  $T_{sp}$  is the temperature at the soldering point of the source lead.

[2] Calculated from S-parameters.

 [3] Measured in [Figure 33](#) test circuit.

 [4] Measured in [Figure 34](#) test circuit.

## 2. Pinning information

**Table 2. Discrete pinning**

Pin	Description	Simplified outline	Symbol
1	gate1 (AMP A)		
2	gate2		
3	gate1 (AMP B)		
4	drain (AMP B)		
5	source		
6	drain (AMP A)		

### 3. Ordering information

Table 3. Ordering information

Type number	Package		
	Name	Description	Version
BF1208D	-	plastic surface-mounted package; 6 leads	SOT666

### 4. Marking

Table 4. Marking codes

Type number	Marking code
BF1208D	4A

### 5. Limiting values

Table 5. Limiting values

In accordance with the Absolute Maximum Rating System (IEC 60134).

Symbol	Parameter	Conditions	Min	Max	Unit
<b>Per MOSFET</b>					
$V_{DS}$	drain-source voltage	DC	-	6	V
$I_D$	drain current	DC	-	30	mA
$I_{G1}$	gate1 current		-	±10	mA
$I_{G2}$	gate2 current		-	±10	mA
$P_{tot}$	total power dissipation	$T_{sp} \leq 109\text{ °C}$ [1]	-	180	mW
$T_{stg}$	storage temperature		-65	+150	°C
$T_j$	junction temperature		-	150	°C

[1]  $T_{sp}$  is the temperature at the soldering point of the source lead.

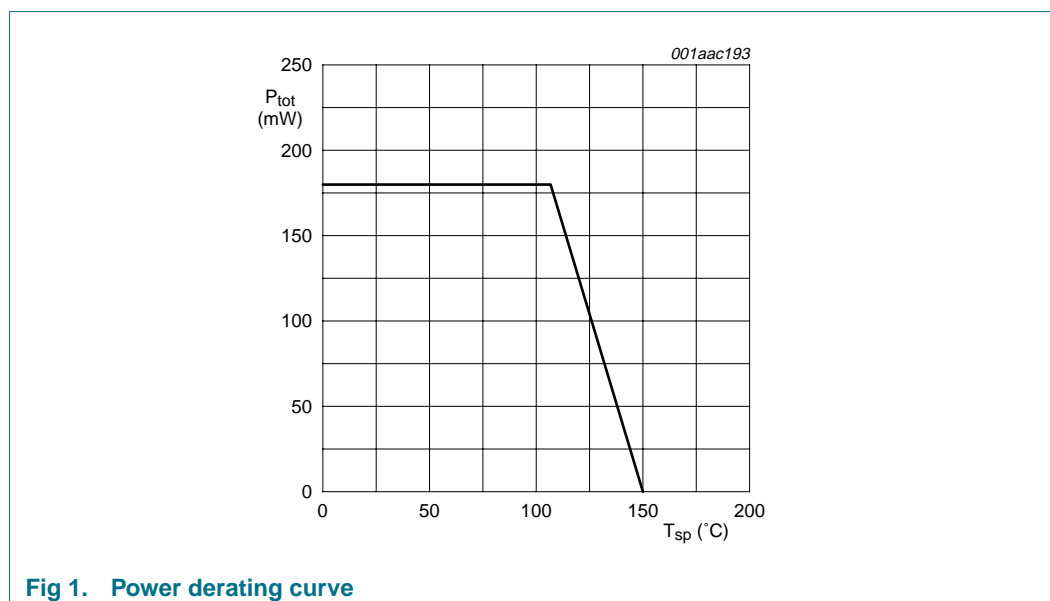

Fig 1. Power derating curve

## 6. Thermal characteristics

**Table 6. Thermal characteristics**

Symbol	Parameter	Conditions	Typ	Unit
$R_{th(j-sp)}$	thermal resistance from junction to solder point		225	K/W

## 7. Static characteristics

**Table 7. Static characteristics**

$T_j = 25\text{ }^\circ\text{C}$ ; unless otherwise specified.

Symbol	Parameter	Conditions	Min	Typ	Max	Unit	
<b>Per MOSFET; unless otherwise specified</b>							
$V_{(BR)DSS}$	drain-source breakdown voltage	$V_{G1-S} = V_{G2-S} = 0\text{ V}$ ; $I_D = 10\text{ }\mu\text{A}$					
		amplifier A	6	-	-	V	
		amplifier B	6	-	-	V	
$V_{(BR)G1-SS}$	gate1-source breakdown voltage	$V_{G2-S} = V_{DS} = 0\text{ V}$ ; $I_{G1-S} = 10\text{ mA}$	6	-	10	V	
$V_{(BR)G2-SS}$	gate2-source breakdown voltage	$V_{G1-S} = V_{DS} = 0\text{ V}$ ; $I_{G2-S} = 10\text{ mA}$	6	-	10	V	
$V_{F(S-G1)}$	forward source-gate1 voltage	$V_{G2-S} = V_{DS} = 0\text{ V}$ ; $I_{S-G1} = 10\text{ mA}$	0.5	-	1.5	V	
$V_{F(S-G2)}$	forward source-gate2 voltage	$V_{G1-S} = V_{DS} = 0\text{ V}$ ; $I_{S-G2} = 10\text{ mA}$	0.5	-	1.5	V	
$V_{G1-S(th)}$	gate1-source threshold voltage	$V_{DS} = 5\text{ V}$ ; $V_{G2-S} = 4\text{ V}$ ; $I_D = 100\text{ }\mu\text{A}$	0.3	-	1.0	V	
$V_{G2-S(th)}$	gate2-source threshold voltage	$V_{DS} = 5\text{ V}$ ; $V_{G1-S} = 5\text{ V}$ ; $I_D = 100\text{ }\mu\text{A}$	0.4	-	1.0	V	
$I_{DS}$	drain-source current	$V_{G2-S} = 4\text{ V}$ ; $V_{DS(B)} = 5\text{ V}$ ; $R_{G1} = 86\text{ k}\Omega$					
		amplifier A; $V_{DS(A)} = 5\text{ V}$	[1]	14	-	24	mA
		amplifier B	[2]	10	-	20	mA
$I_{G1-S}$	gate1 cut-off current	$V_{G2-S} = V_{DS(A)} = 0\text{ V}$					
		amplifier A; $V_{G1-S(A)} = 5\text{ V}$ ; $I_{D(B)} = 0\text{ A}$	-	-	50	nA	
		amplifier B; $V_{G1-S(B)} = 5\text{ V}$ ; $V_{DS(B)} = 0\text{ V}$	-	-	50	nA	
$I_{G2-S}$	gate2 cut-off current	$V_{G2-S} = 4\text{ V}$ ; $V_{G1-S(B)} = 0\text{ V}$ ; $V_{G1-S(A)} = V_{DS(A)} = V_{DS(B)} = 0\text{ V}$	-	-	20	nA	

[1]  $R_{G1}$  connects gate1 (B) to  $V_{GG} = 0\text{ V}$  (see [Figure 3](#)).

[2]  $R_{G1}$  connects gate1 (B) to  $V_{GG} = 5\text{ V}$  (see [Figure 3](#)).

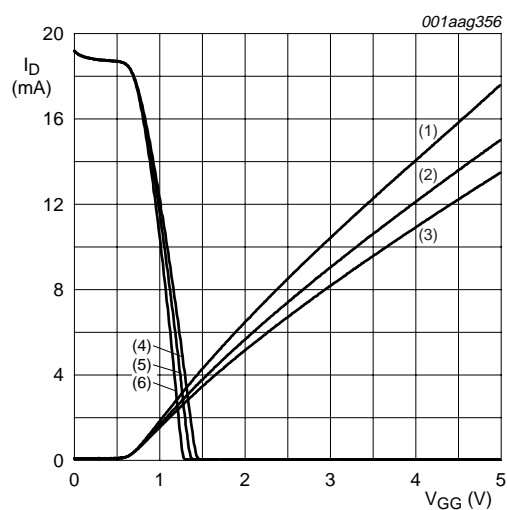

- (1)  $I_{D(B)}$ ;  $R_{G1} = 68 \text{ k}\Omega$ .  
 (2)  $I_{D(B)}$ ;  $R_{G1} = 86 \text{ k}\Omega$ .  
 (3)  $I_{D(B)}$ ;  $R_{G1} = 100 \text{ k}\Omega$ .  
 (4)  $I_{D(A)}$ ;  $R_{G1} = 100 \text{ k}\Omega$ .  
 (5)  $I_{D(A)}$ ;  $R_{G1} = 86 \text{ k}\Omega$ .  
 (6)  $I_{D(A)}$ ;  $R_{G1} = 68 \text{ k}\Omega$ .

Fig 2. Drain currents of MOSFET A and B as a function of  $V_{GG}$

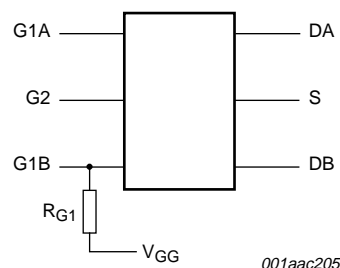

$V_{GG} = 5 \text{ V}$ : amplifier A is off; amplifier B is on.  
 $V_{GG} = 0 \text{ V}$ : amplifier A is on; amplifier B is off.

Fig 3. Functional diagram

## 8. Dynamic characteristics

### 8.1 Dynamic characteristics for amplifier A

Table 8. Dynamic characteristics for amplifier A<sup>[1]</sup>

Common source;  $T_{amb} = 25 \text{ }^\circ\text{C}$ ;  $V_{G2-S} = 4 \text{ V}$ ;  $V_{DS} = 5 \text{ V}$ ;  $I_D = 19 \text{ mA}$ ; unless otherwise specified.

Symbol	Parameter	Conditions	Min	Typ	Max	Unit
$ y_{fs} $	forward transfer admittance	$f = 100 \text{ MHz}$ ; $T_j = 25 \text{ }^\circ\text{C}$	26	31	41	mS
$C_{iss(G1)}$	input capacitance at gate1	$f = 100 \text{ MHz}$	[2]	-	2.1	2.6 pF
$C_{iss(G2)}$	input capacitance at gate2	$f = 100 \text{ MHz}$	[2]	-	3.4	pF
$C_{oss}$	output capacitance	$f = 100 \text{ MHz}$	[2]	-	0.8	pF
$C_{rss}$	reverse transfer capacitance	$f = 100 \text{ MHz}$	[2]	-	30	fF
$G_{tr}$	transducer power gain	$B_S = B_{S(opt)}$ ; $B_L = B_{L(opt)}$				
		$f = 200 \text{ MHz}$ ; $G_S = 2 \text{ mS}$ ; $G_L = 0.5 \text{ mS}$	32	36	40	dB
		$f = 400 \text{ MHz}$ ; $G_S = 2 \text{ mS}$ ; $G_L = 1 \text{ mS}$	28	32	36	dB
		$f = 800 \text{ MHz}$ ; $G_S = 3.3 \text{ mS}$ ; $G_L = 1 \text{ mS}$	24	28	33	dB
NF	noise figure	$f = 11 \text{ MHz}$ ; $G_S = 20 \text{ mS}$ ; $B_S = 0 \text{ S}$	-	3.0	-	dB
		$f = 400 \text{ MHz}$ ; $Y_S = Y_{S(opt)}$	-	0.9	1.5	dB
		$f = 800 \text{ MHz}$ ; $Y_S = Y_{S(opt)}$	-	1.1	1.7	dB

**Table 8. Dynamic characteristics for amplifier A<sup>[1]</sup> ...continued**Common source;  $T_{amb} = 25\text{ }^{\circ}\text{C}$ ;  $V_{G2-S} = 4\text{ V}$ ;  $V_{DS} = 5\text{ V}$ ;  $I_D = 19\text{ mA}$ ; unless otherwise specified.

Symbol	Parameter	Conditions	Min	Typ	Max	Unit
Xmod	cross modulation	input level for $k = 1\%$ ; $f_w = 50\text{ MHz}$ ; $f_{unw} = 60\text{ MHz}$	[3]			
		at 0 dB AGC	90	-	-	dB $\mu$ V
		at 10 dB AGC	-	90	-	dB $\mu$ V
		at 20 dB AGC	-	99	-	dB $\mu$ V
		at 40 dB AGC	102	105	-	dB $\mu$ V

[1] For the MOSFET not in use:  $V_{G1-S(B)} = 0\text{ V}$ ;  $V_{DS(B)} = 0\text{ V}$ .

[2] Calculated from S-parameters.

[3] Measured in [Figure 33](#) test circuit.

### 8.1.1 Graphics for amplifier A

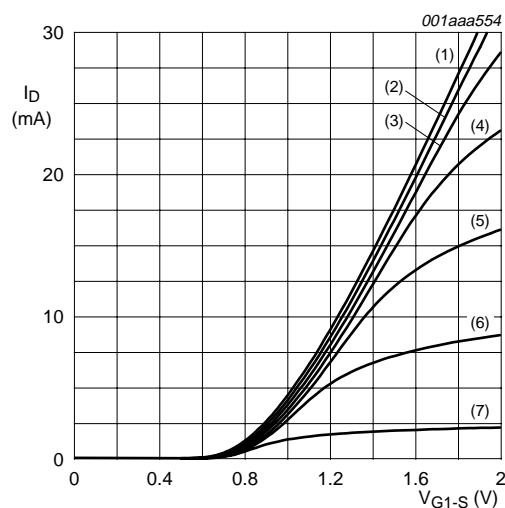

- (1)  $V_{G2-S} = 4\text{ V}$ .  
 (2)  $V_{G2-S} = 3.5\text{ V}$ .  
 (3)  $V_{G2-S} = 3\text{ V}$ .  
 (4)  $V_{G2-S} = 2.5\text{ V}$ .  
 (5)  $V_{G2-S} = 2\text{ V}$ .  
 (6)  $V_{G2-S} = 1.5\text{ V}$ .  
 (7)  $V_{G2-S} = 1\text{ V}$ .  
 $V_{DS(A)} = 5\text{ V}$ ;  $V_{G1-S(B)} = V_{DS(B)} = 0\text{ V}$ ;  $T_j = 25\text{ }^{\circ}\text{C}$ .

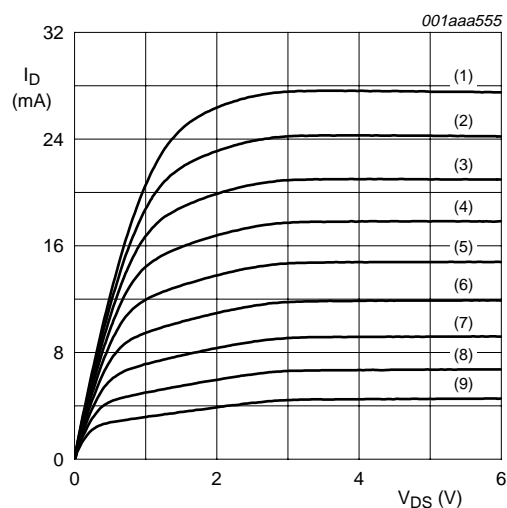
**Fig 4. Amplifier A: transfer characteristics; typical values**

- (1)  $V_{G1-S(A)} = 1.8\text{ V}$ .  
 (2)  $V_{G1-S(A)} = 1.7\text{ V}$ .  
 (3)  $V_{G1-S(A)} = 1.6\text{ V}$ .  
 (4)  $V_{G1-S(A)} = 1.5\text{ V}$ .  
 (5)  $V_{G1-S(A)} = 1.4\text{ V}$ .  
 (6)  $V_{G1-S(A)} = 1.3\text{ V}$ .  
 (7)  $V_{G1-S(A)} = 1.2\text{ V}$ .  
 (8)  $V_{G1-S(A)} = 1.1\text{ V}$ .  
 (9)  $V_{G1-S(A)} = 1\text{ V}$ .  
 $V_{G2-S} = 4\text{ V}$ ;  $V_{G1-S(B)} = V_{DS(B)} = 0\text{ V}$ ;  $T_j = 25\text{ }^{\circ}\text{C}$ .

**Fig 5. Amplifier A: output characteristics; typical values**

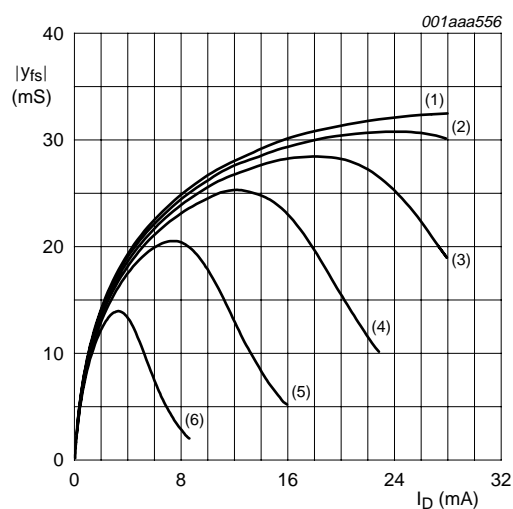

- (1)  $V_{G2-S} = 4 \text{ V}$ .  
 (2)  $V_{G2-S} = 3.5 \text{ V}$ .  
 (3)  $V_{G2-S} = 3 \text{ V}$ .  
 (4)  $V_{G2-S} = 2.5 \text{ V}$ .  
 (5)  $V_{G2-S} = 2 \text{ V}$ .  
 (6)  $V_{G2-S} = 1.5 \text{ V}$ .  
 $V_{DS(A)} = 5 \text{ V}$ ;  $V_{G1-S(B)} = V_{DS(B)} = 0 \text{ V}$ ;  $T_j = 25 \text{ }^\circ\text{C}$ .

**Fig 6. Amplifier A: forward transfer admittance as a function of drain current; typical values**

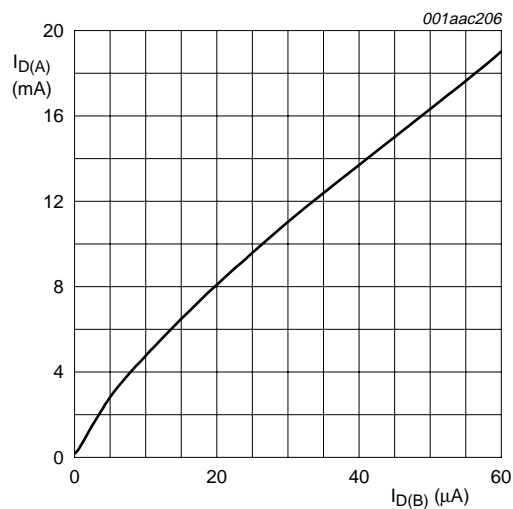

- $V_{DS(A)} = 5 \text{ V}$ ;  $V_{G2-S} = 4 \text{ V}$ ;  $V_{DS(B)} = 5 \text{ V}$ ;  
 $V_{G1-S(B)} = 0 \text{ V}$ ;  $T_j = 25 \text{ }^\circ\text{C}$ .  
 $I_{D(B)}$  = internal gate1 current = current in pin drain (AMP B) if MOSFET (B) is switched off.

**Fig 7. Amplifier A: drain current as a function of internal gate1 current; typical values**

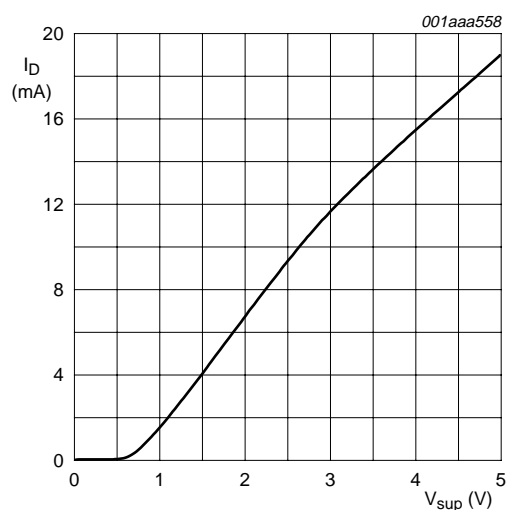

$V_{DS(A)} = V_{DS(B)} = V_{sup}$ ;  $V_{G2-S} = 4$  V;  $T_j = 25$  °C;  
 $R_{G1} = 86$  k $\Omega$  (connected to ground); see [Figure 3](#).

**Fig 8. Amplifier A: drain current of amplifier A as a function of supply voltage of A and B amplifier; typical values**

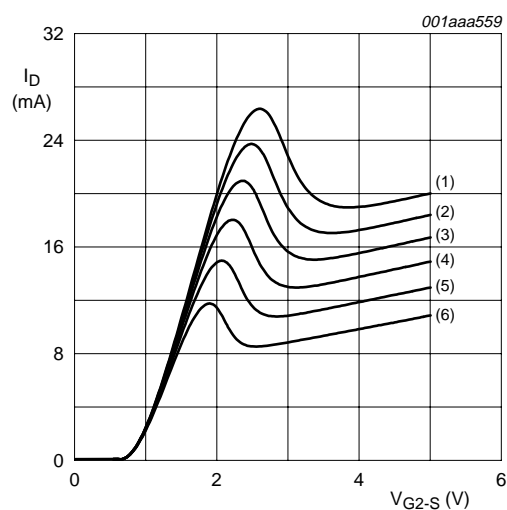

(1)  $V_{DS(B)} = 5$  V.  
 (2)  $V_{DS(B)} = 4.5$  V.  
 (3)  $V_{DS(B)} = 4$  V.  
 (4)  $V_{DS(B)} = 3.5$  V.  
 (5)  $V_{DS(B)} = 3$  V.  
 (6)  $V_{DS(B)} = 2.5$  V.  
 $V_{DS(A)} = 5$  V;  $V_{G1-S(B)} = 0$  V; gate1 (AMP A) is open;  
 $T_j = 25$  °C.

**Fig 9. Amplifier A: drain current as a function of gate2 voltage; typical values**

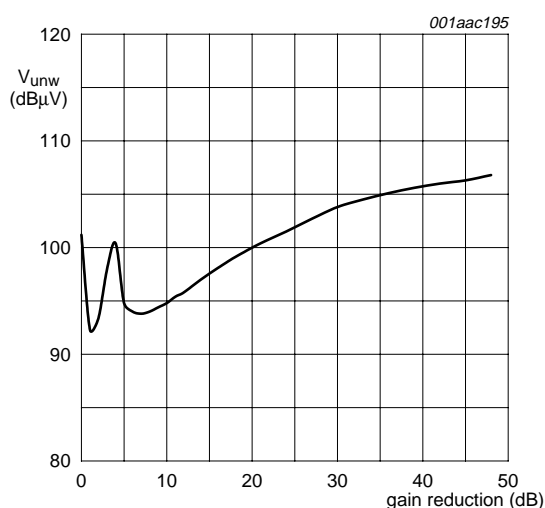

$V_{DS(A)} = V_{DS(B)} = 5$  V;  $V_{G1-S(B)} = 0$  V;  $f_w = 50$  MHz;  
 $f_{unw} = 60$  MHz;  $T_{amb} = 25$  °C; see [Figure 33](#).

**Fig 10. Amplifier A: unwanted voltage for 1 % cross modulation as a function of gain reduction; typical values**

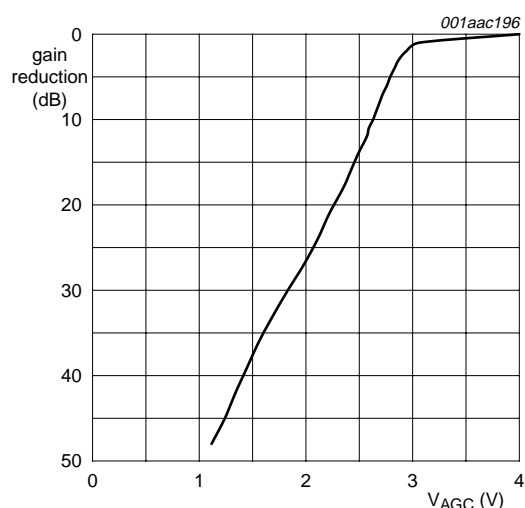

$V_{DS(A)} = V_{DS(B)} = 5$  V;  $V_{G1-S(B)} = 0$  V;  $f = 50$  MHz;  
 see [Figure 33](#).

**Fig 11. Amplifier A: gain reduction as a function of AGC voltage; typical values**



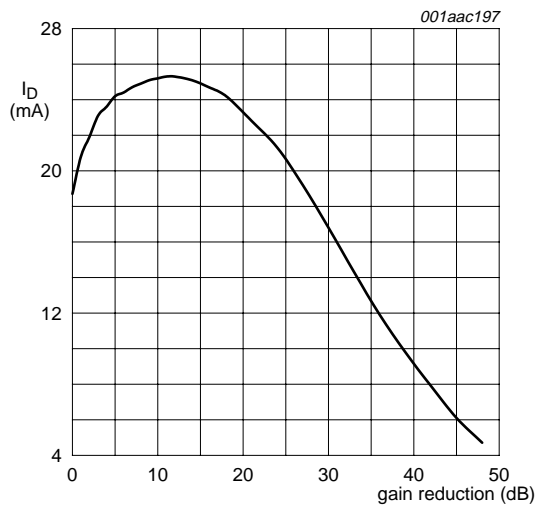

$V_{DS(A)} = V_{DS(B)} = 5\text{ V}$ ;  $V_{G1-S(B)} = 0\text{ V}$ ;  $f = 50\text{ MHz}$ ;  
 $T_{amb} = 25\text{ °C}$ ; see [Figure 33](#).

**Fig 12. Amplifier A: drain current as a function of gain reduction; typical values**

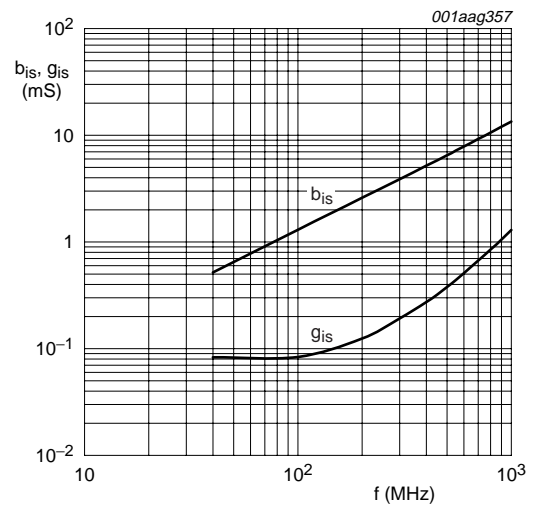

$V_{DS(A)} = 5\text{ V}$ ;  $V_{G2-S} = 4\text{ V}$ ;  $V_{DS(B)} = V_{G1-S(B)} = 0\text{ V}$ ;  
 $I_{D(A)} = 19\text{ mA}$

**Fig 13. Amplifier A: input admittance as a function of frequency; typical values**

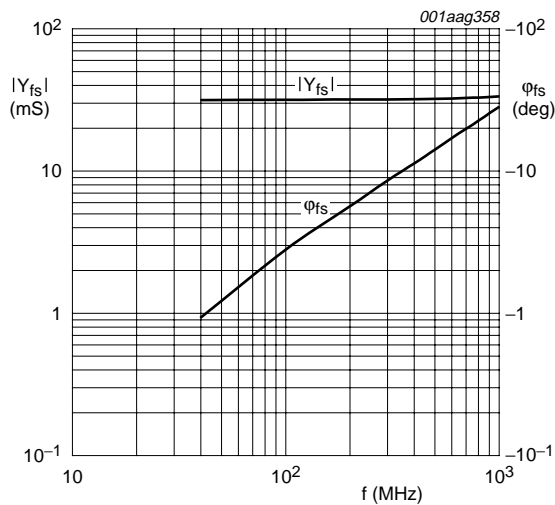

$V_{DS(A)} = 5\text{ V}$ ;  $V_{G2-S} = 4\text{ V}$ ;  $V_{DS(B)} = V_{G1-S(B)} = 0\text{ V}$ ;  
 $I_{D(A)} = 19\text{ mA}$

**Fig 14. Amplifier A: forward transfer admittance and phase as a function of frequency; typical values**

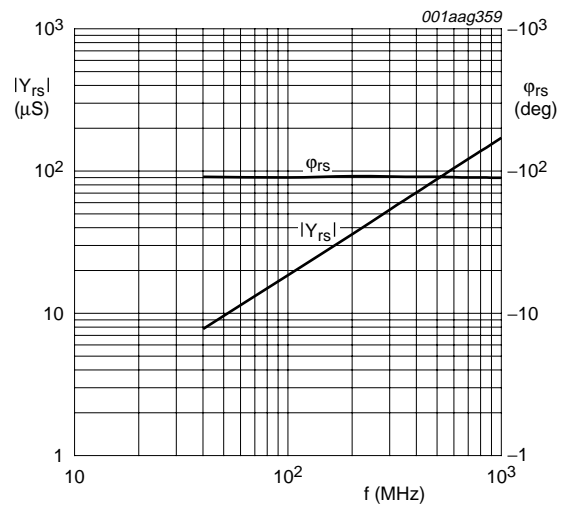

$V_{DS(A)} = 5\text{ V}$ ;  $V_{G2-S} = 4\text{ V}$ ;  $V_{DS(B)} = V_{G1-S(B)} = 0\text{ V}$ ;  
 $I_{D(A)} = 19\text{ mA}$

**Fig 15. Amplifier A: reverse transfer admittance and phase as a function of frequency; typical values**

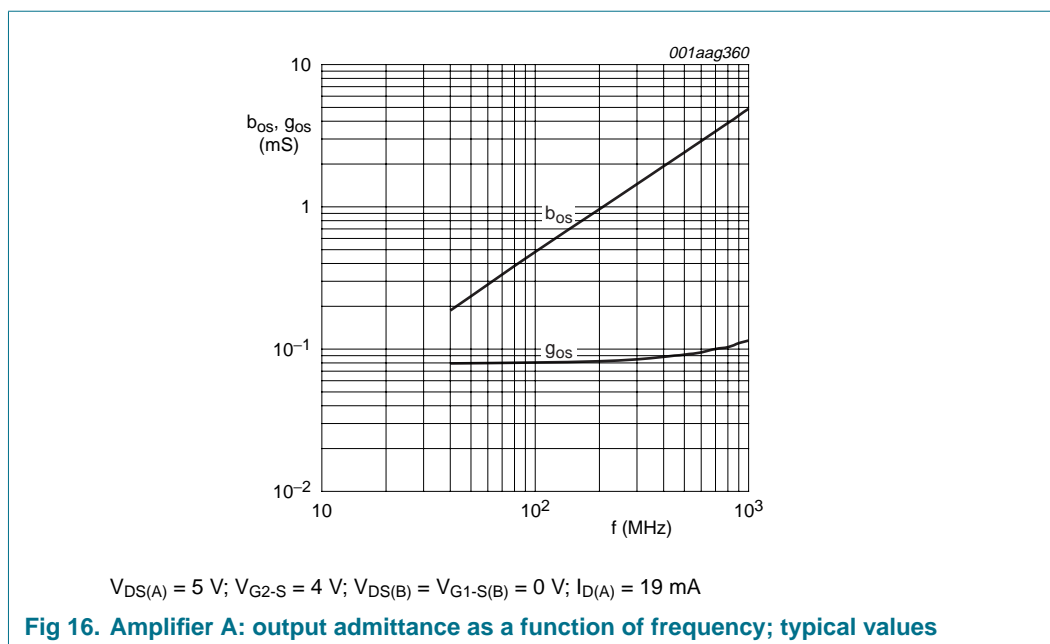

### 8.1.2 Scattering parameters for amplifier A

**Table 9. Scattering parameters for amplifier A**

$V_{DS(A)} = 5\text{ V}; V_{G2-S} = 4\text{ V}; I_{D(A)} = 19\text{ mA}; V_{DS(B)} = 0\text{ V}; V_{G1-S(B)} = 0\text{ V}; T_{amb} = 25\text{ }^{\circ}\text{C};$  typical values.

f (MHz)	S <sub>11</sub>		S <sub>21</sub>		S <sub>12</sub>		S <sub>22</sub>	
	Magnitude (ratio)	Angle (deg)	Magnitude (ratio)	Angle (deg)	Magnitude (ratio)	Angle (deg)	Magnitude (ratio)	Angle (deg)
40	0.992	-3.037	3.21	177.04	0.00763	87.34	0.992	-1.139
100	0.99152	-7.62	3.13270	172.06	0.00182	85.21	0.99168	-2.93
200	0.98685	-15.12	3.11006	164.12	0.00350	78.32	0.99047	-5.83
300	0.97979	-22.49	3.06743	156.24	0.00511	73.45	0.98876	-8.72
400	0.97176	-29.74	3.01634	148.56	0.00664	69.12	0.98662	-11.57
500	0.96209	-36.76	2.95125	141.00	0.00805	64.73	0.98424	-14.39
600	0.95108	-43.63	2.87828	133.56	0.00931	60.38	0.98168	-17.21
700	0.93915	-50.35	2.79946	126.28	0.01042	56.16	0.97884	-19.97
800	0.92742	-56.82	2.71508	119.20	0.01141	52.16	0.97630	-22.68
900	0.91573	-62.95	2.62937	112.29	0.01224	48.31	0.97350	-25.42
1000	0.90429	-68.83	2.54239	105.56	0.01297	44.63	0.97115	-28.14

### 8.1.3 Noise data for amplifier A

**Table 10. Noise data for amplifier A**

$V_{DS(A)} = 5\text{ V}; V_{G2-S} = 4\text{ V}; I_{D(A)} = 19\text{ mA}; V_{DS(B)} = 0\text{ V}; V_{G1-S(B)} = 0\text{ V}; T_{amb} = 25\text{ }^{\circ}\text{C};$  typical values; unless otherwise specified.

f (MHz)	NF <sub>min</sub> (dB)	Γ <sub>opt</sub>		r <sub>n</sub> (ratio)
		(ratio)	(deg)	
400	0.9	0.77	22.7	0.65
800	1.1	0.73	45.75	0.62

## 8.2 Dynamic characteristics for amplifier B

**Table 11. Dynamic characteristics for amplifier B<sup>[1]</sup>**

Common source;  $T_{amb} = 25\text{ °C}$ ;  $V_{G2-S} = 4\text{ V}$ ;  $V_{DS} = 5\text{ V}$ ;  $I_D = 15\text{ mA}$ ; unless otherwise specified.

Symbol	Parameter	Conditions	Min	Typ	Max	Unit
$ y_{fs} $	forward transfer admittance	$f = 100\text{ MHz}$ ; $T_j = 25\text{ °C}$	25	30	40	mS
$C_{iss(G1)}$	input capacitance at gate1	$f = 100\text{ MHz}$	[2]	-	2.1	2.6 pF
$C_{iss(G2)}$	input capacitance at gate2	$f = 100\text{ MHz}$	[2]	-	3.4	pF
$C_{oss}$	output capacitance	$f = 100\text{ MHz}$	[2]	-	0.85	pF
$C_{rss}$	reverse transfer capacitance	$f = 100\text{ MHz}$	[2]	-	30	fF
$G_{tr}$	transducer power gain	$B_S = B_{S(opt)}$ ; $B_L = B_{L(opt)}$				
		$f = 200\text{ MHz}$ ; $G_S = 2\text{ mS}$ ; $G_L = 0.5\text{ mS}$	31	35	39	dB
		$f = 400\text{ MHz}$ ; $G_S = 2\text{ mS}$ ; $G_L = 1\text{ mS}$	28	32	36	dB
		$f = 800\text{ MHz}$ ; $G_S = 3.3\text{ mS}$ ; $G_L = 1\text{ mS}$	26	30	34	dB
NF	noise figure	$f = 11\text{ MHz}$ ; $G_S = 20\text{ mS}$ ; $B_S = 0\text{ S}$	-	3	-	dB
		$f = 400\text{ MHz}$ ; $Y_S = Y_{S(opt)}$	-	1.1	1.7	dB
		$f = 800\text{ MHz}$ ; $Y_S = Y_{S(opt)}$	-	1.4	2.0	dB
Xmod	cross modulation	input level for $k = 1\%$ ; $f_w = 50\text{ MHz}$ ; $f_{unw} = 60\text{ MHz}$ [3]				
		at 0 dB AGC	90	-	-	dB $\mu$ V
		at 10 dB AGC	-	90	-	dB $\mu$ V
		at 20 dB AGC	-	98	-	dB $\mu$ V
		at 40 dB AGC	102	105	-	dB $\mu$ V

[1] For the MOSFET not in use:  $V_{G1-S(A)} = 0\text{ V}$ ;  $V_{DS(A)} = 0\text{ V}$ .

[2] Calculated from S-parameters.

[3] Measured in [Figure 34](#) test circuit.

## 8.2.1 Graphics for amplifier B

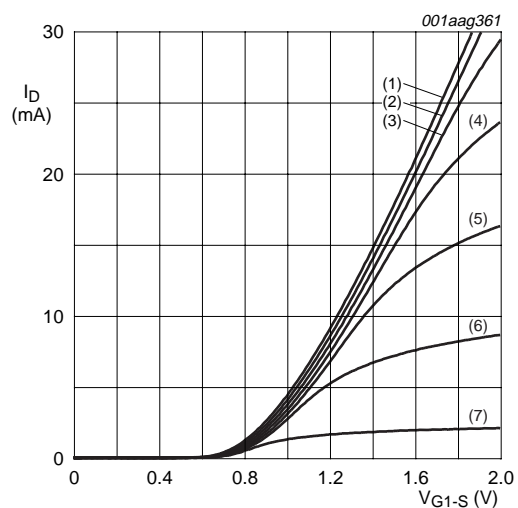

- (1)  $V_{G2-S} = 4 \text{ V}$ .
- (2)  $V_{G2-S} = 3.5 \text{ V}$ .
- (3)  $V_{G2-S} = 3 \text{ V}$ .
- (4)  $V_{G2-S} = 2.5 \text{ V}$ .
- (5)  $V_{G2-S} = 2 \text{ V}$ .
- (6)  $V_{G2-S} = 1.5 \text{ V}$ .
- (7)  $V_{G2-S} = 1 \text{ V}$ .

$V_{DS(B)} = 5 \text{ V}$ ;  $V_{DS(A)} = V_{G1-S(A)} = 0 \text{ V}$ ;  $T_j = 25 \text{ }^\circ\text{C}$ .

**Fig 17. Amplifier B: transfer characteristics; typical values**

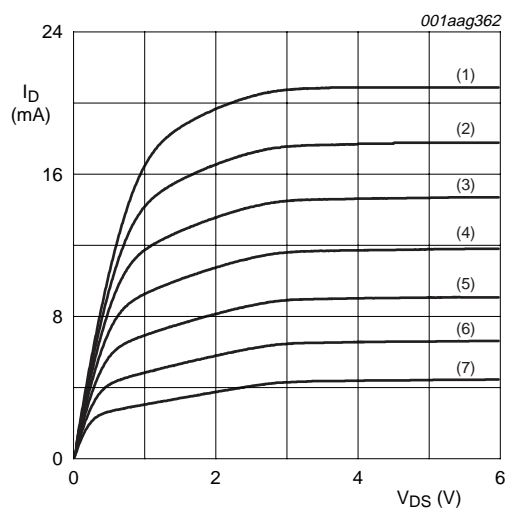

- (1)  $V_{G1-S(B)} = 1.6 \text{ V}$ .
- (2)  $V_{G1-S(B)} = 1.5 \text{ V}$ .
- (3)  $V_{G1-S(B)} = 1.4 \text{ V}$ .
- (4)  $V_{G1-S(B)} = 1.3 \text{ V}$ .
- (5)  $V_{G1-S(B)} = 1.2 \text{ V}$ .
- (6)  $V_{G1-S(B)} = 1.1 \text{ V}$ .
- (7)  $V_{G1-S(B)} = 1 \text{ V}$ .

$V_{G2-S} = 4 \text{ V}$ ;  $V_{DS(A)} = V_{G1-S(A)} = 0 \text{ V}$ ;  $T_j = 25 \text{ }^\circ\text{C}$ .

**Fig 18. Amplifier B: output characteristics; typical values**

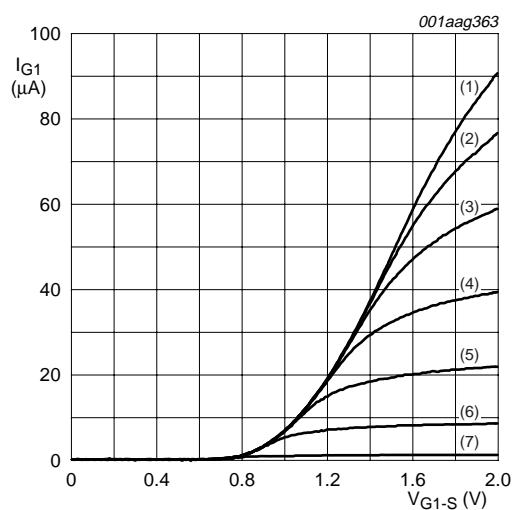

- (1)  $V_{G2-S} = 4 \text{ V}$ .  
 (2)  $V_{G2-S} = 3.5 \text{ V}$ .  
 (3)  $V_{G2-S} = 3 \text{ V}$ .  
 (4)  $V_{G2-S} = 2.5 \text{ V}$ .  
 (5)  $V_{G2-S} = 2 \text{ V}$ .  
 (6)  $V_{G2-S} = 1.5 \text{ V}$ .  
 (7)  $V_{G2-S} = 1 \text{ V}$ .  
 $V_{DS(B)} = 5 \text{ V}$ ;  $V_{DS(A)} = V_{G1-S(A)} = 0 \text{ V}$ ;  $T_j = 25 \text{ }^\circ\text{C}$ .

**Fig 19. Amplifier B: gate1 current as a function of gate1 voltage; typical values**

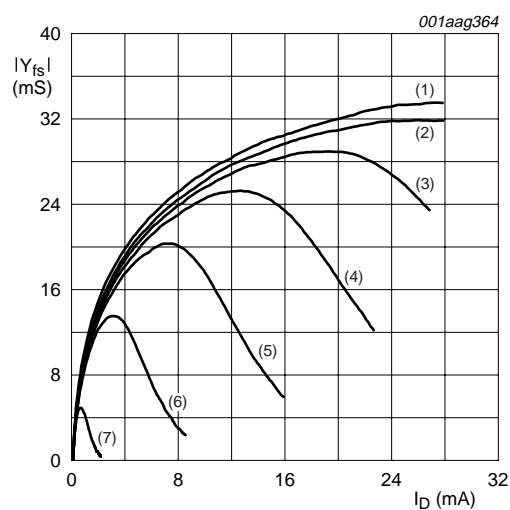

- (1)  $V_{G2-S} = 4 \text{ V}$ .  
 (2)  $V_{G2-S} = 3.5 \text{ V}$ .  
 (3)  $V_{G2-S} = 3 \text{ V}$ .  
 (4)  $V_{G2-S} = 2.5 \text{ V}$ .  
 (5)  $V_{G2-S} = 2 \text{ V}$ .  
 (6)  $V_{G2-S} = 1.5 \text{ V}$ .  
 (7)  $V_{G2-S} = 1 \text{ V}$ .  
 $V_{DS(B)} = 5 \text{ V}$ ;  $V_{DS(A)} = V_{G1-S(A)} = 0 \text{ V}$ ;  $T_j = 25 \text{ }^\circ\text{C}$ .

**Fig 20. Amplifier B: forward transfer admittance as a function of drain current; typical values**

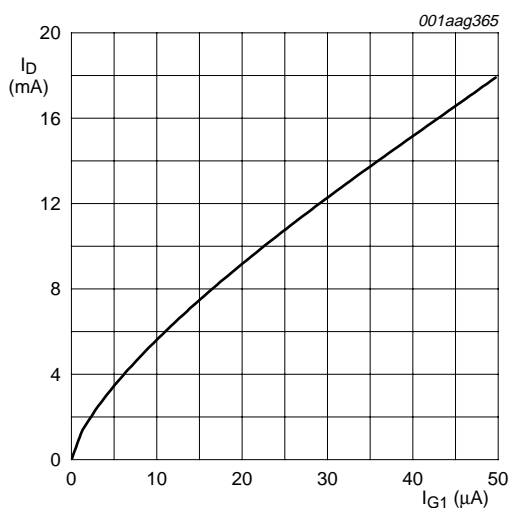

$V_{DS(B)} = 5 \text{ V}$ ;  $V_{G2-S} = 4 \text{ V}$ ;  $V_{DS(A)} = V_{G1-S(A)} = 0 \text{ V}$ ;  
 $T_j = 25 \text{ }^\circ\text{C}$ .

**Fig 21. Amplifier B: drain current as a function of gate1 current; typical values**

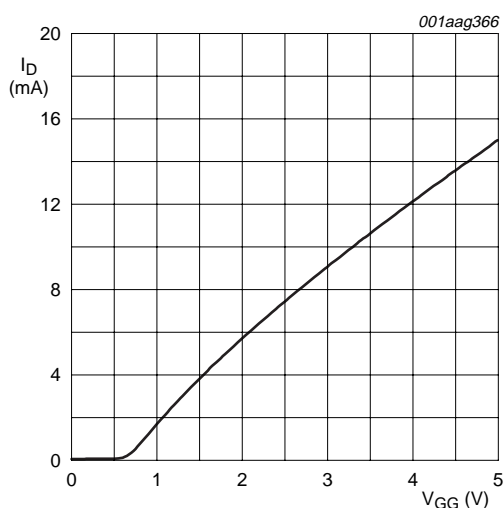

$V_{DS(B)} = 5 \text{ V}$ ;  $V_{G2-S} = 4 \text{ V}$ ;  $V_{DS(A)} = V_{G1-S(A)} = 0 \text{ V}$ ;  
 $T_j = 25 \text{ }^\circ\text{C}$ ;  $R_{G1} = 86 \text{ k}\Omega$  (connected to  $V_{GG}$ ); see  
[Figure 3](#).

**Fig 22. Amplifier B: drain current as a function of gate1 supply voltage; typical values**

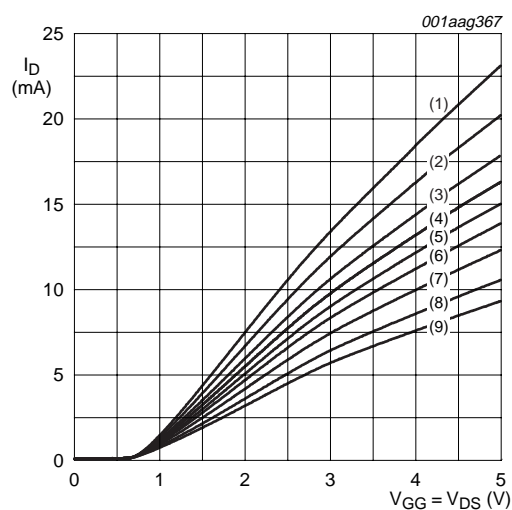

- (1)  $R_{G1} = 47 \text{ k}\Omega$ .
- (2)  $R_{G1} = 56 \text{ k}\Omega$ .
- (3)  $R_{G1} = 68 \text{ k}\Omega$ .
- (4)  $R_{G1} = 82 \text{ k}\Omega$ .
- (5)  $R_{G1} = 86 \text{ k}\Omega$ .
- (6)  $R_{G1} = 100 \text{ k}\Omega$ .
- (7)  $R_{G1} = 120 \text{ k}\Omega$ .
- (8)  $R_{G1} = 150 \text{ k}\Omega$ .
- (9)  $R_{G1} = 180 \text{ k}\Omega$ .

$V_{G2-S} = 4 \text{ V}$ ;  $V_{DS(A)} = V_{G1-S(A)} = 0 \text{ V}$ ;  $T_j = 25 \text{ }^\circ\text{C}$ ;  
 $R_{G1}$  is connected to  $V_{GG}$ ; see [Figure 3](#).

**Fig 23. Amplifier B: drain current as a function of gate1 supply voltage and drain supply voltage; typical values**

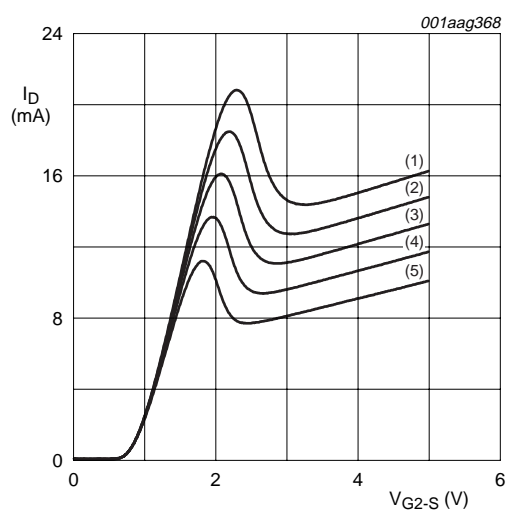

- (1)  $V_{GG} = 5.0 \text{ V}$ .
- (2)  $V_{GG} = 4.5 \text{ V}$ .
- (3)  $V_{GG} = 4.0 \text{ V}$ .
- (4)  $V_{GG} = 3.5 \text{ V}$ .
- (5)  $V_{GG} = 3.0 \text{ V}$ .

$V_{DS(B)} = 5 \text{ V}$ ;  $V_{DS(A)} = V_{G1-S(A)} = 0 \text{ V}$ ;  $T_j = 25 \text{ }^\circ\text{C}$ ;  
 $R_{G1} = 86 \text{ k}\Omega$  (connected to  $V_{GG}$ ); see [Figure 3](#).

**Fig 24. Amplifier B: drain current as a function of gate2 voltage; typical values**

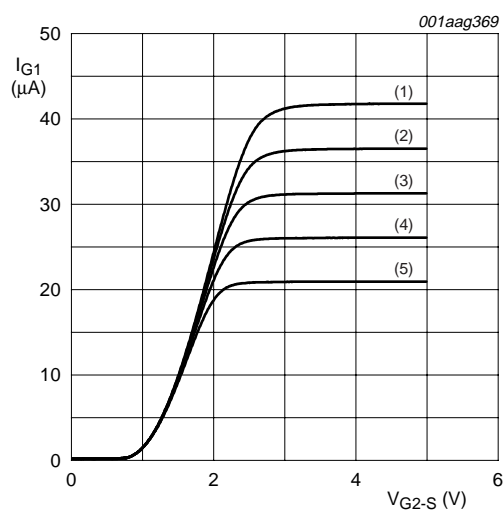

- (1)  $V_{GG} = 5.0$  V.
- (2)  $V_{GG} = 4.5$  V.
- (3)  $V_{GG} = 4.0$  V.
- (4)  $V_{GG} = 3.5$  V.
- (5)  $V_{GG} = 3.0$  V.

$V_{DS(B)} = 5$  V;  $V_{DS(A)} = V_{G1-S(A)} = 0$  V;  $T_j = 25$  °C;  
 $R_{G1} = 86$  k $\Omega$  (connected to  $V_{GG}$ ); see [Figure 3](#).

**Fig 25. Amplifier B: gate1 current as a function of gate2 voltage; typical values**

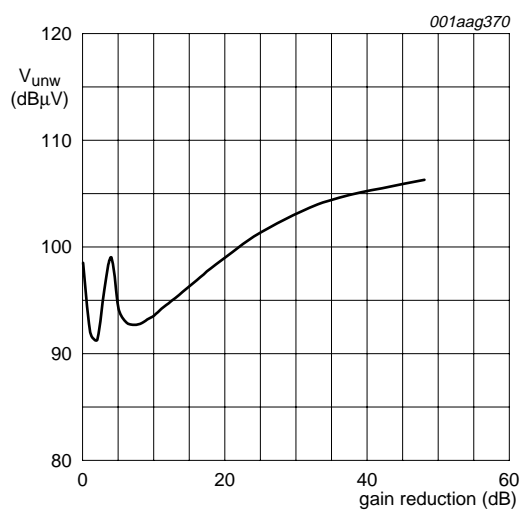

$V_{DS(B)} = 5$  V;  $V_{GG} = 5$  V;  $V_{DS(A)} = V_{G1-S(A)} = 0$  V;  
 $R_{G1} = 86$  k $\Omega$  (connected to  $V_{GG}$ );  $f_w = 50$  MHz;  
 $f_{unw} = 60$  MHz;  $T_{amb} = 25$  °C; see [Figure 34](#).

**Fig 26. Amplifier B: unwanted voltage for 1% cross modulation as a function of gain reduction; typical values**

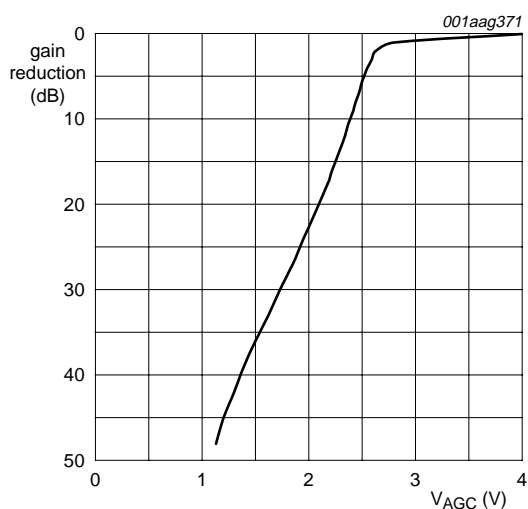

$V_{DS(B)} = 5$  V;  $V_{GG} = 5$  V;  $V_{DS(A)} = V_{G1-S(A)} = 0$  V;  
 $R_{G1} = 86$  k $\Omega$  (connected to  $V_{GG}$ );  $f = 50$  MHz;  
 $T_{amb} = 25$  °C; see [Figure 34](#).

**Fig 27. Amplifier B: gain reduction as a function of AGC voltage; typical values**

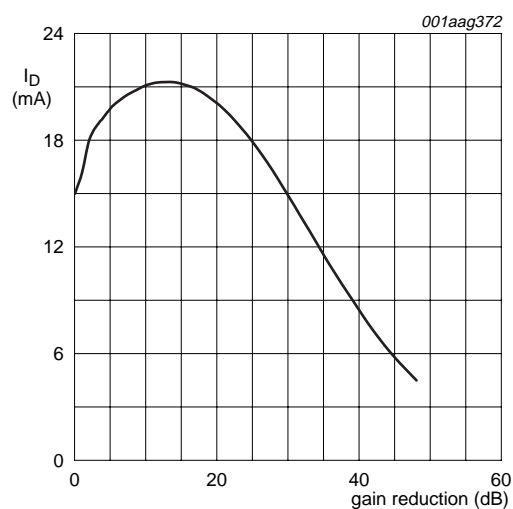

$V_{DS(B)} = 5$  V;  $V_{GG} = 5$  V;  $V_{DS(A)} = V_{G1-S(A)} = 0$  V;  
 $R_{G1} = 86$  k $\Omega$  (connected to  $V_{GG}$ );  $f = 50$  MHz;  
 $T_{amb} = 25$  °C; see [Figure 34](#).

**Fig 28. Amplifier B: drain current as a function of gain reduction; typical values**

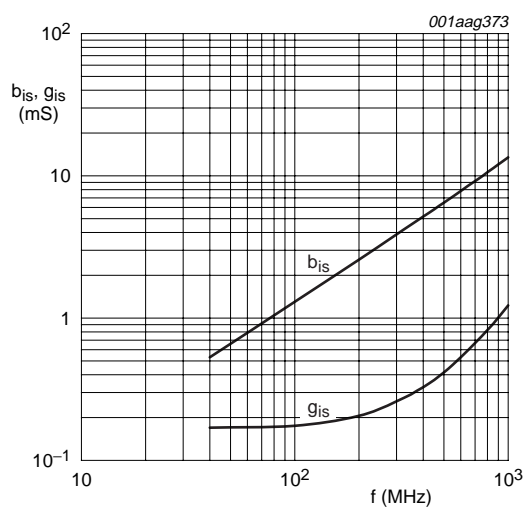

$V_{DS(B)} = 5$  V;  $V_{G2-S} = 4$  V;  $V_{DS(A)} = V_{G1-S(A)} = 0$  V;  
 $I_{D(B)} = 15$  mA

Fig 29. Amplifier B: input admittance as a function of frequency; typical values

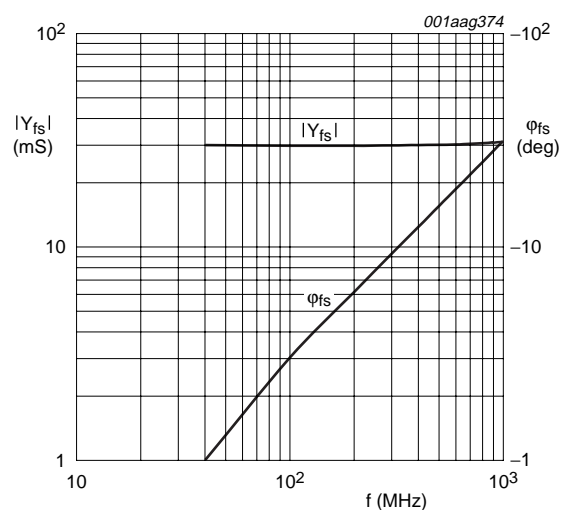

$V_{DS(B)} = 5$  V;  $V_{G2-S} = 4$  V;  $V_{DS(A)} = V_{G1-S(A)} = 0$  V;  
 $I_{D(B)} = 15$  mA

Fig 30. Amplifier B: forward transfer admittance and phase as a function of frequency; typical values

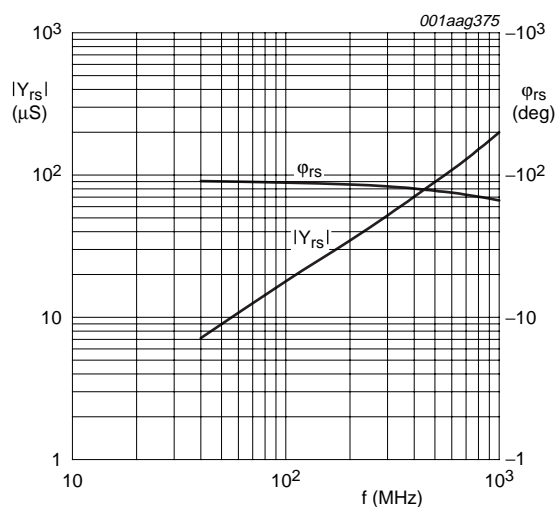

$V_{DS(B)} = 5$  V;  $V_{G2-S} = 4$  V;  $V_{DS(A)} = V_{G1-S(A)} = 0$  V;  
 $I_{D(B)} = 15$  mA

Fig 31. Amplifier B: reverse transfer admittance and phase as a function of frequency; typical values

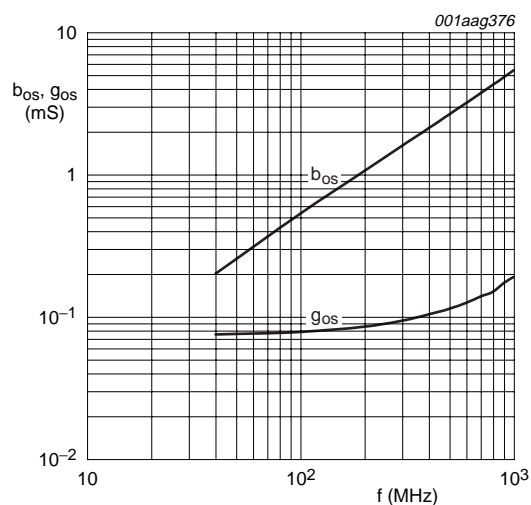

$V_{DS(B)} = 5$  V;  $V_{G2-S} = 4$  V;  $V_{DS(A)} = V_{G1-S(A)} = 0$  V;  
 $I_{D(B)} = 15$  mA

Fig 32. Amplifier B: output admittance as a function of frequency; typical values



## 8.2.2 Scattering parameters for amplifier B

**Table 12. Scattering parameters for amplifier B**

$V_{DS(B)} = 5\text{ V}$ ;  $V_{G2-S} = 4\text{ V}$ ;  $I_{D(B)} = 15\text{ mA}$ ;  $V_{DS(A)} = 0\text{ V}$ ;  $V_{G1-S(A)} = 0\text{ V}$ ;  $T_{amb} = 25\text{ °C}$ ; typical values.

f (MHz)	S <sub>11</sub>		S <sub>21</sub>		S <sub>12</sub>		S <sub>22</sub>	
	Magnitude (ratio)	Angle (deg)	Magnitude (ratio)	Angle (deg)	Magnitude (ratio)	Angle (deg)	Magnitude (ratio)	Angle (deg)
40	0.9830	-3.09	2.96410	176.88	0.00070	87.02	0.9920	-1.22
100	0.98257	-7.62	2.92951	171.69	0.00176	86.41	0.99190	-3.22
200	0.97956	-15.00	2.90869	163.43	0.00339	83.66	0.99064	-6.42
300	0.97446	-22.33	2.86877	155.20	0.00501	81.33	0.98894	-9.59
400	0.96849	-29.56	2.82073	147.13	0.00663	79.12	0.98688	-12.74
500	0.96112	-36.62	2.75891	139.15	0.00820	76.85	0.98454	-15.88
600	0.95238	-43.55	2.68790	131.26	0.00967	74.48	0.98181	-19.02
700	0.94282	-50.37	2.61038	123.50	0.01110	72.29	0.97880	-22.13
800	0.93319	-56.94	2.52719	115.92	0.01250	70.11	0.97585	-25.20
900	0.92326	-63.22	2.44054	108.46	0.01379	67.93	0.97175	-28.30
1000	0.91325	-69.31	2.35036	101.13	0.01506	65.65	0.96801	-31.40

## 8.2.3 Noise data for amplifier B

**Table 13. Noise data for amplifier B**

$V_{DS(B)} = 5\text{ V}$ ;  $V_{G2-S} = 4\text{ V}$ ;  $I_{D(B)} = 15\text{ mA}$ ;  $V_{DS(A)} = 0\text{ V}$ ;  $V_{G1-S(A)} = 0\text{ V}$ ;  $T_{amb} = 25\text{ °C}$ ; typical values; unless otherwise specified.

f (MHz)	NF <sub>min</sub> (dB)	Γ <sub>opt</sub>		r <sub>n</sub> (Ω)
		(ratio)	(deg)	
400	1.1	0.72	22.83	0.66
800	1.4	0.68	46.42	0.64

## 9. Test information

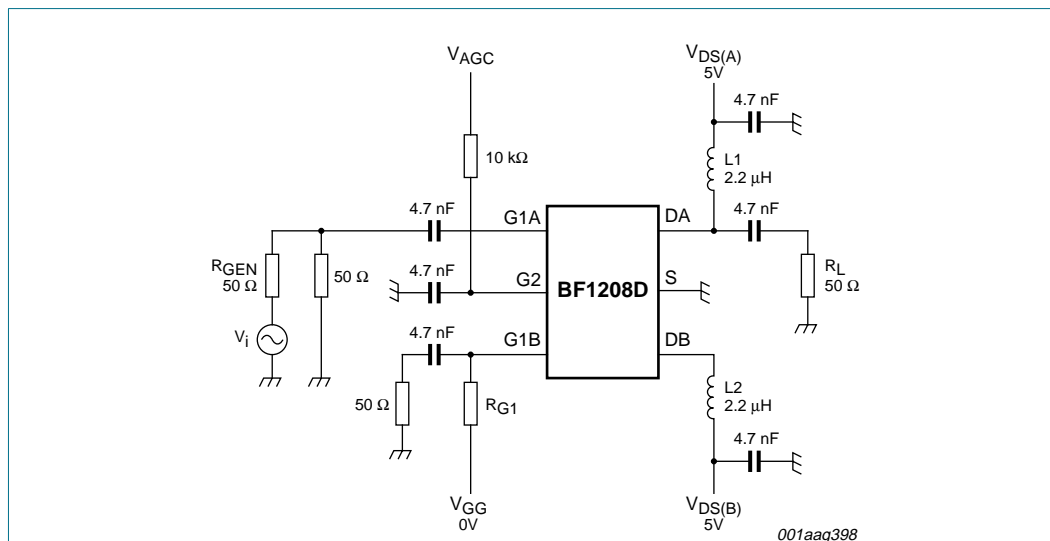

Fig 33. Cross modulation test set-up for amplifier A

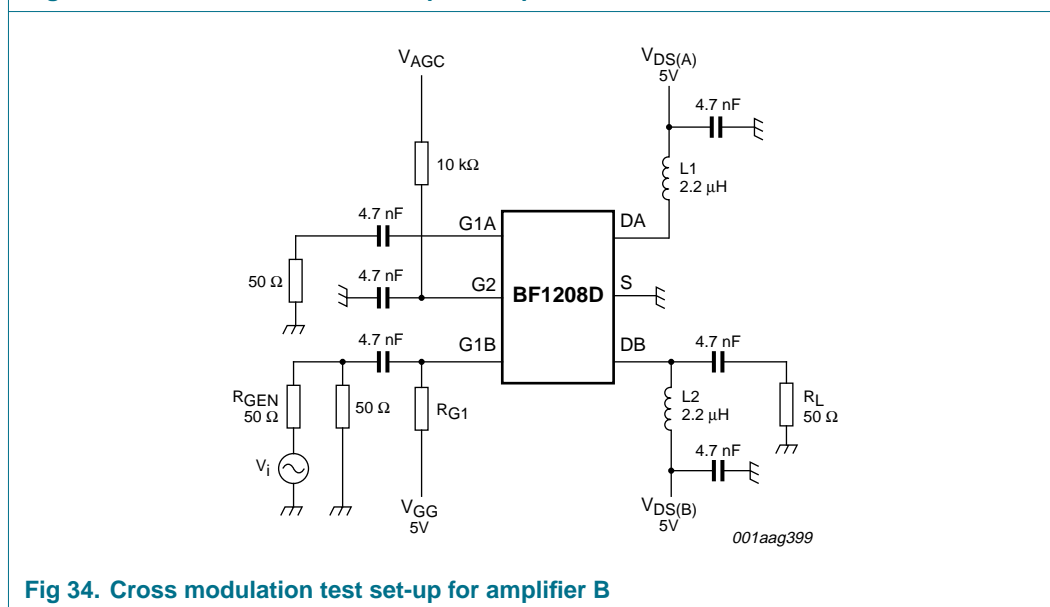

Fig 34. Cross modulation test set-up for amplifier B

**10. Package outline**

Plastic surface-mounted package; 6 leads

SOT666

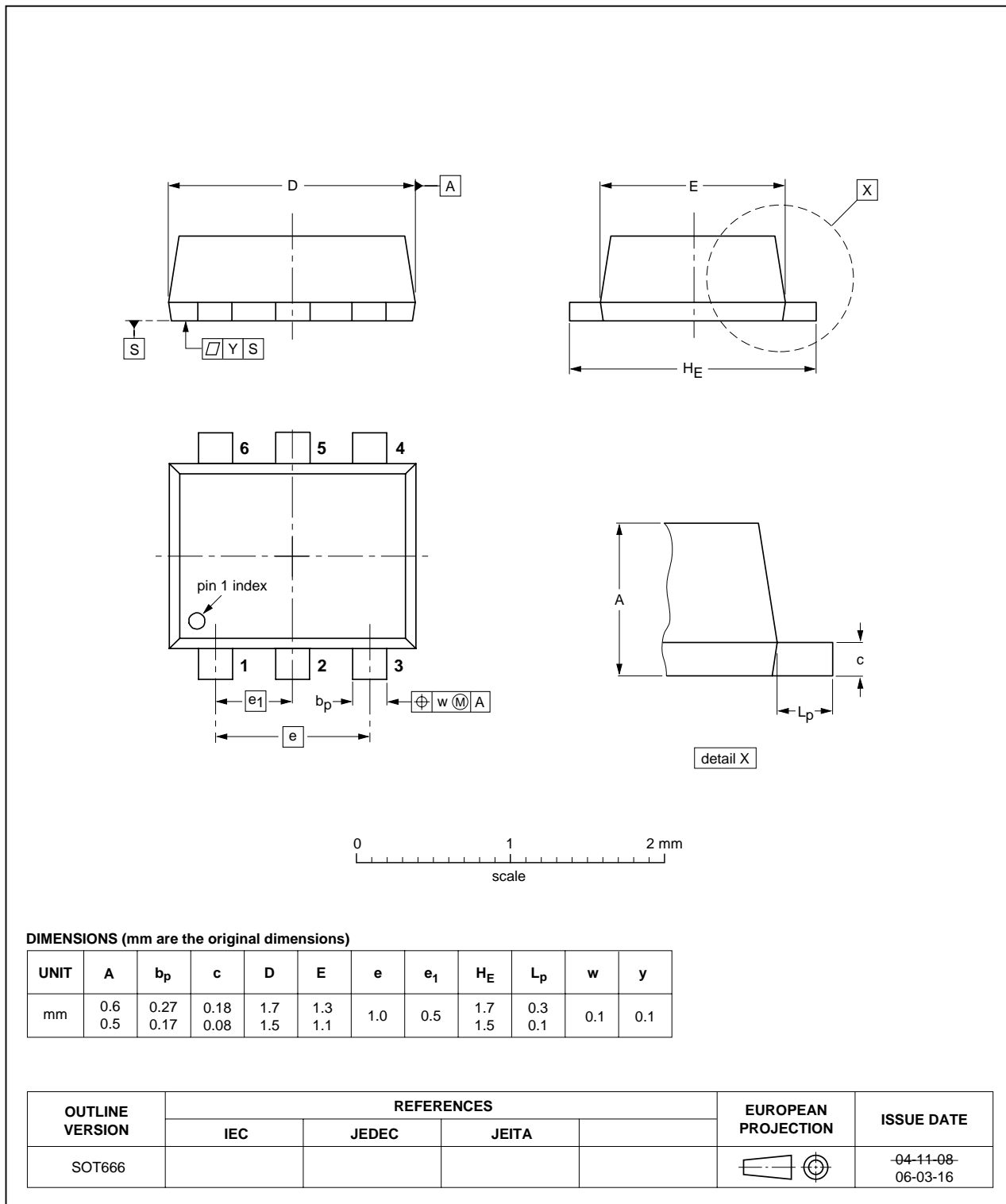

Fig 35. Package outline SOT666

## 11. Abbreviations

**Table 14. Abbreviations**

Acronym	Description
AGC	Automatic Gain Control
DC	Direct Current
MOSFET	Metal-Oxide Semiconductor Field-Effect Transistor
UHF	Ultra High Frequency
VHF	Very High Frequency

## 12. Revision history

**Table 15. Revision history**

Document ID	Release date	Data sheet status	Change notice	Supersedes
BF1208D_1	20070516	Product data sheet	-	-

## 13. Legal information

### 13.1 Data sheet status

Document status <sup>[1][2]</sup>	Product status <sup>[3]</sup>	Definition
Objective [short] data sheet	Development	This document contains data from the objective specification for product development.
Preliminary [short] data sheet	Qualification	This document contains data from the preliminary specification.
Product [short] data sheet	Production	This document contains the product specification.

[1] Please consult the most recently issued document before initiating or completing a design.

[2] The term 'short data sheet' is explained in section "Definitions".

[3] The product status of device(s) described in this document may have changed since this document was published and may differ in case of multiple devices. The latest product status information is available on the Internet at URL <http://www.nxp.com>.

### 13.2 Definitions

**Draft** — The document is a draft version only. The content is still under internal review and subject to formal approval, which may result in modifications or additions. NXP Semiconductors does not give any representations or warranties as to the accuracy or completeness of information included herein and shall have no liability for the consequences of use of such information.

**Short data sheet** — A short data sheet is an extract from a full data sheet with the same product type number(s) and title. A short data sheet is intended for quick reference only and should not be relied upon to contain detailed and full information. For detailed and full information see the relevant full data sheet, which is available on request via the local NXP Semiconductors sales office. In case of any inconsistency or conflict with the short data sheet, the full data sheet shall prevail.

### 13.3 Disclaimers

**General** — Information in this document is believed to be accurate and reliable. However, NXP Semiconductors does not give any representations or warranties, expressed or implied, as to the accuracy or completeness of such information and shall have no liability for the consequences of use of such information.

**Right to make changes** — NXP Semiconductors reserves the right to make changes to information published in this document, including without limitation specifications and product descriptions, at any time and without notice. This document supersedes and replaces all information supplied prior to the publication hereof.

**Suitability for use** — NXP Semiconductors products are not designed, authorized or warranted to be suitable for use in medical, military, aircraft, space or life support equipment, nor in applications where failure or

malfunction of a NXP Semiconductors product can reasonably be expected to result in personal injury, death or severe property or environmental damage. NXP Semiconductors accepts no liability for inclusion and/or use of NXP Semiconductors products in such equipment or applications and therefore such inclusion and/or use is at the customer's own risk.

**Applications** — Applications that are described herein for any of these products are for illustrative purposes only. NXP Semiconductors makes no representation or warranty that such applications will be suitable for the specified use without further testing or modification.

**Limiting values** — Stress above one or more limiting values (as defined in the Absolute Maximum Ratings System of IEC 60134) may cause permanent damage to the device. Limiting values are stress ratings only and operation of the device at these or any other conditions above those given in the Characteristics sections of this document is not implied. Exposure to limiting values for extended periods may affect device reliability.

**Terms and conditions of sale** — NXP Semiconductors products are sold subject to the general terms and conditions of commercial sale, as published at <http://www.nxp.com/profile/terms>, including those pertaining to warranty, intellectual property rights infringement and limitation of liability, unless explicitly otherwise agreed to in writing by NXP Semiconductors. In case of any inconsistency or conflict between information in this document and such terms and conditions, the latter will prevail.

**No offer to sell or license** — Nothing in this document may be interpreted or construed as an offer to sell products that is open for acceptance or the grant, conveyance or implication of any license under any copyrights, patents or other industrial or intellectual property rights.

### 13.4 Trademarks

Notice: All referenced brands, product names, service names and trademarks are the property of their respective owners.

## 14. Contact information

For additional information, please visit: <http://www.nxp.com>

For sales office addresses, send an email to: [salesaddresses@nxp.com](mailto:salesaddresses@nxp.com)

## 15. Contents

<b>1</b>	<b>Product profile</b> . . . . .	<b>1</b>
1.1	General description . . . . .	1
1.2	Features . . . . .	1
1.3	Applications . . . . .	1
1.4	Quick reference data . . . . .	2
<b>2</b>	<b>Pinning information</b> . . . . .	<b>2</b>
<b>3</b>	<b>Ordering information</b> . . . . .	<b>3</b>
<b>4</b>	<b>Marking</b> . . . . .	<b>3</b>
<b>5</b>	<b>Limiting values</b> . . . . .	<b>3</b>
<b>6</b>	<b>Thermal characteristics</b> . . . . .	<b>4</b>
<b>7</b>	<b>Static characteristics</b> . . . . .	<b>4</b>
<b>8</b>	<b>Dynamic characteristics</b> . . . . .	<b>5</b>
8.1	Dynamic characteristics for amplifier A . . . . .	5
8.1.1	Graphics for amplifier A . . . . .	6
8.1.2	Scattering parameters for amplifier A . . . . .	10
8.1.3	Noise data for amplifier A . . . . .	10
8.2	Dynamic characteristics for amplifier B . . . . .	11
8.2.1	Graphics for amplifier B . . . . .	12
8.2.2	Scattering parameters for amplifier B . . . . .	17
8.2.3	Noise data for amplifier B . . . . .	17
<b>9</b>	<b>Test information</b> . . . . .	<b>18</b>
<b>10</b>	<b>Package outline</b> . . . . .	<b>19</b>
<b>11</b>	<b>Abbreviations</b> . . . . .	<b>20</b>
<b>12</b>	<b>Revision history</b> . . . . .	<b>20</b>
<b>13</b>	<b>Legal information</b> . . . . .	<b>21</b>
13.1	Data sheet status . . . . .	21
13.2	Definitions . . . . .	21
13.3	Disclaimers . . . . .	21
13.4	Trademarks . . . . .	21
<b>14</b>	<b>Contact information</b> . . . . .	<b>21</b>
<b>15</b>	<b>Contents</b> . . . . .	<b>22</b>

Please be aware that important notices concerning this document and the product(s) described herein, have been included in section 'Legal information'.

founded by

**PHILIPS**

© NXP B.V. 2007.

All rights reserved.

For more information, please visit: <http://www.nxp.com>

For sales office addresses, please send an email to: [salesaddresses@nxp.com](mailto:salesaddresses@nxp.com)

Date of release: 16 May 2007

Document identifier: BF1208D\_1