



BYD Microelectronics Co., Ltd.

BF960NF06

60V N-Channel MOSFET

General Description

This Power MOSFET device has specifically been designed to minimize input capacitance and gate charge. It is therefore suitable as primary switch in advanced high-efficiency, high-frequency isolated DC-DC converters for Telecom and Computer applications. It is also intended for any application with low gate drive requirement.

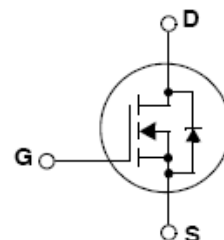

Features

- $V_{DS} = 60\text{ V}$
- $I_D = 60\text{ A}$
- Typical $R_{DS(ON)} = 10\text{ m}\Omega$ ($V_{GS} = 10\text{ V}, I_D = 30\text{ A}$)
- Fast switching
- 100% avalanche tested
- Improved dv/dt capability

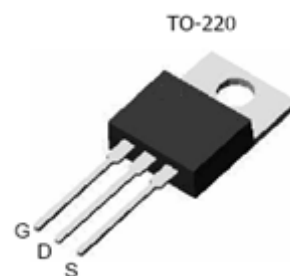

Absolute Maximum Ratings

Symbol	Parameter	Value	Unit
V_{DS}	Drain-Source Voltage	60	V
I_D	Drain Current(continuous)at $T_c = 25^\circ\text{C}$	60	A
I_{DM}	Drain Current (pulsed) (Note1)	240	A
V_{GS}	Gate-Source Voltage	± 20	V
E_{AS}	Single Pulse Avalanche Energy (Note2)	215	mJ
I_{AR}	Avalanche Current (Note1)	38	A
P_D	Power Dissipation ($T_c = 25^\circ\text{C}$)	138	W
T_J, T_{stg}	Operating junction and Storage Temperature Range	-55 to +150	$^\circ\text{C}$
T_L	Maximum Lead Temperature for Soldering Purpose	300	$^\circ\text{C}$



Ordering Information

Part Number	Package	Packaging
BF960NF06	TO-220	Tape & reel

Thermal Data

Symbol	Parameter	Max.	Unit
Rthj-Case	Thermal Resistance Junction-Case	0.9	°C/W
Rthj-Amb	Thermal Resistance Junction-Ambient	62	°C/W

Electrical Characteristics(T_c = 25°C)

Symbol	Parameter	Test Conditions	Min.	Typ.	Max.	Unit
V _{(BR)DSS}	Drain-Source Breakdown Voltage	I _D =250uA, V _{GS} =0V	60			V
I _{DSS}	Zero Gate Voltage Drain Current	V _{DS} =60V, V _{GS} =0V, T _c =25°C			1	uA
		V _{DS} =60V, V _{GS} =0V, T _c =125°C			10	uA
I _{GSS}	Gate-Body Leakage Current	V _{GS} =±20V, V _{DS} =0V			±100	nA
V _{GS(th)}	Gate Threshold Voltage	V _{DS} =V _{GS} , I _D =250uA	1.2		2.5	V
R _{DS(on)}	Static Drain-Source On Resistance	V _{GS} =10V, I _D =30A		10	12	mΩ
C _{iss}	Input Capacitance	V _{DS} =25V, f=1MHz, V _{GS} =0V		4283		pF
C _{OSS}	Output Capacitance			159		pF
C _{rSS}	Reverse Transfer Capacitance			7		pF
t _{d(on)}	Turn-On Delay Time	V _{DD} =30V, I _D =30A V _{GS} =10V, R _G =4.7Ω (Note3, 4)		23		ns
t _r	Rise Time			15		ns
t _{d(off)}	Turn-Off Delay Time			95		ns
t _f	Fall Time			11		ns
Q _g	Total Gate Charge	V _{DS} =48V, I _D =12A V _{GS} =4.5V (Note3, 4)		24		nC
Q _{gs}	Gate-Source Charge			7		nC
Q _{gd}	Gate-Drain Charge			10		nC
V _{SD} (*)	Forward On Voltage	I _{SD} =25A, V _{GS} =0V			1.2	V
T _{rr}	Reverse Recovery Time	V _{DD} =40V, I _F =70A, di/dt=100A/us (Note3)		70		ns

Notes:

1. Repetitive Rating : Pulse width limited by maximum junction temperature
 2. V_{DD} = 30V, L = 2mH, Starting T_J = 25°C
 3. Pulse Test : Pulse width ≤ 300μs, duty cycle ≤ 2%
 4. Essentially independent of operating temperature
- (*)Pulsed:Pulse duration



Typical characteristics (25°C unless noted)

Figure 1 Output Characteristics

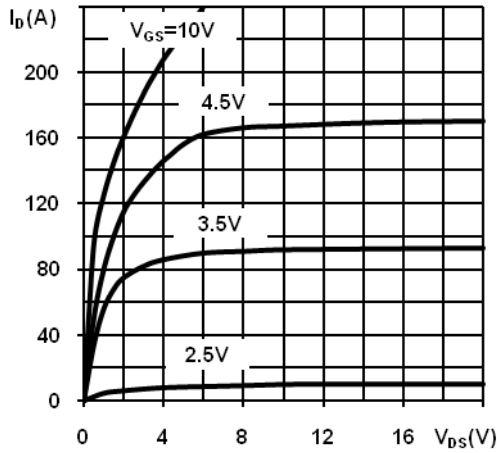

Figure 2 Transfer Characteristics

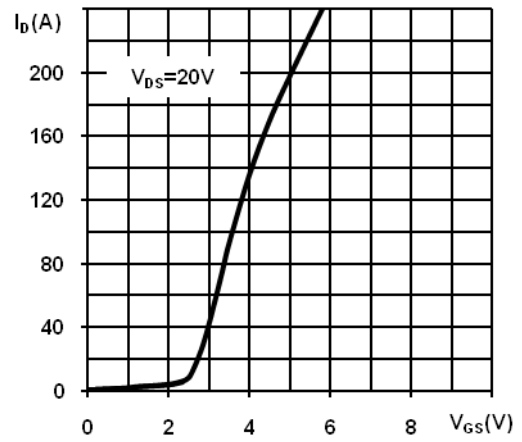

Figure 3 Normalized Threshold Voltage Vs. Temperature

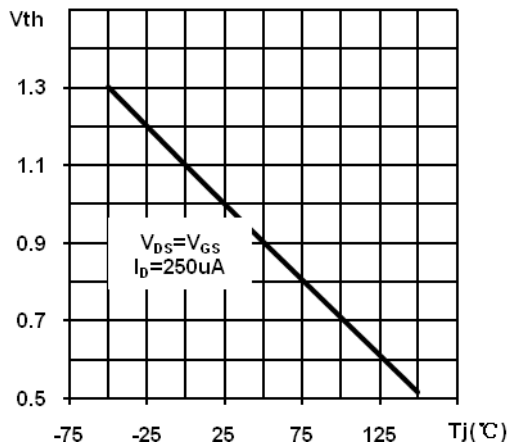

Figure 4 Normalized BV_{DSS} Vs. Temperature

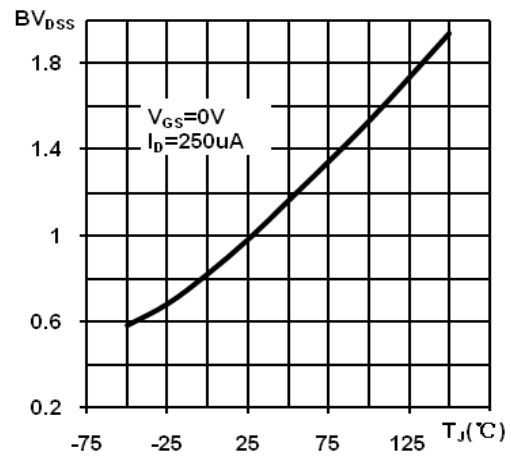

Figure 5 Normalized on Resistance Vs. Temperature

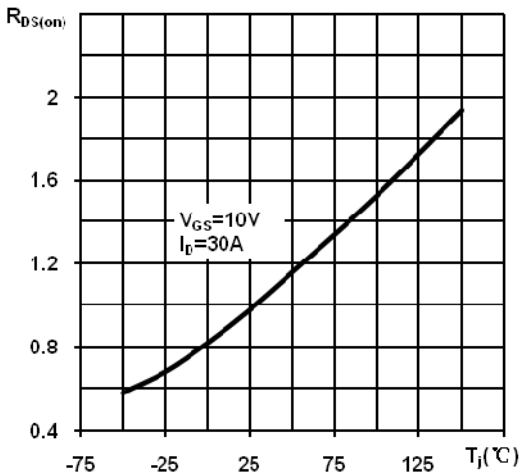

Figure 6 Source-Drain Diode Forward Characteristics

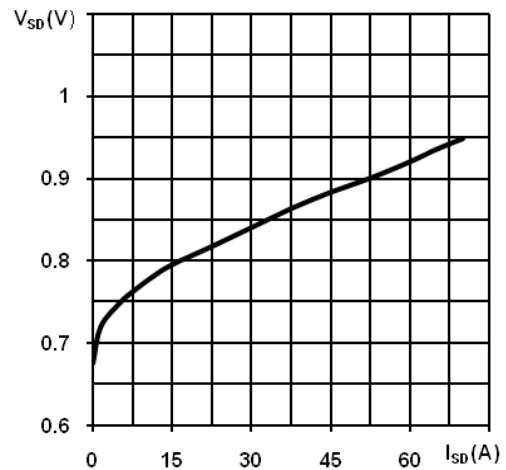

Figure 7 Capacitance

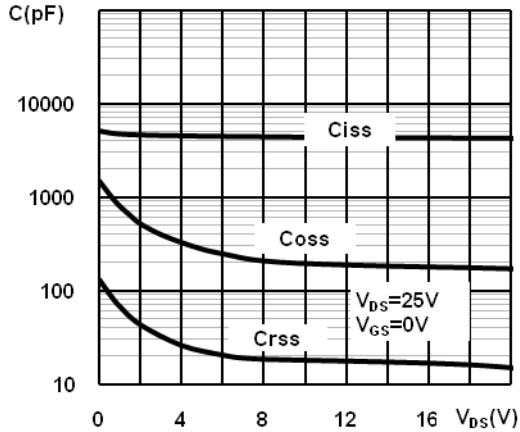

Figure 8 Gate Charge

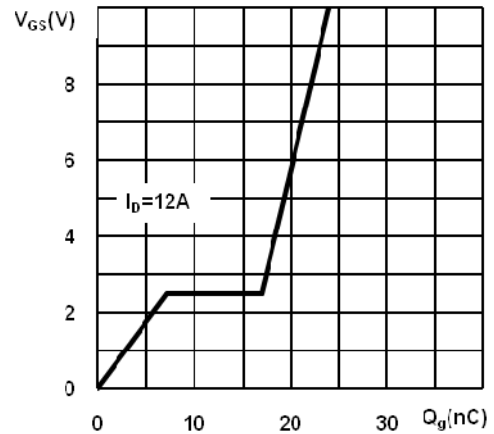

Figure 9 Safe Operating Area

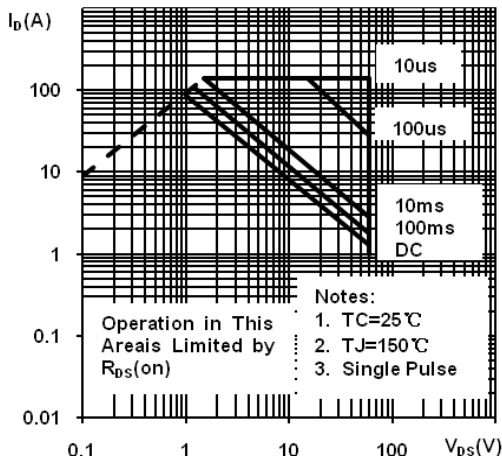

Figure 10 Maximum Drain Current Vs. Case Temperature

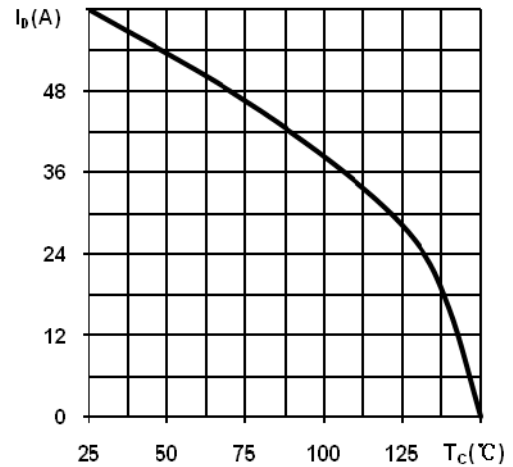
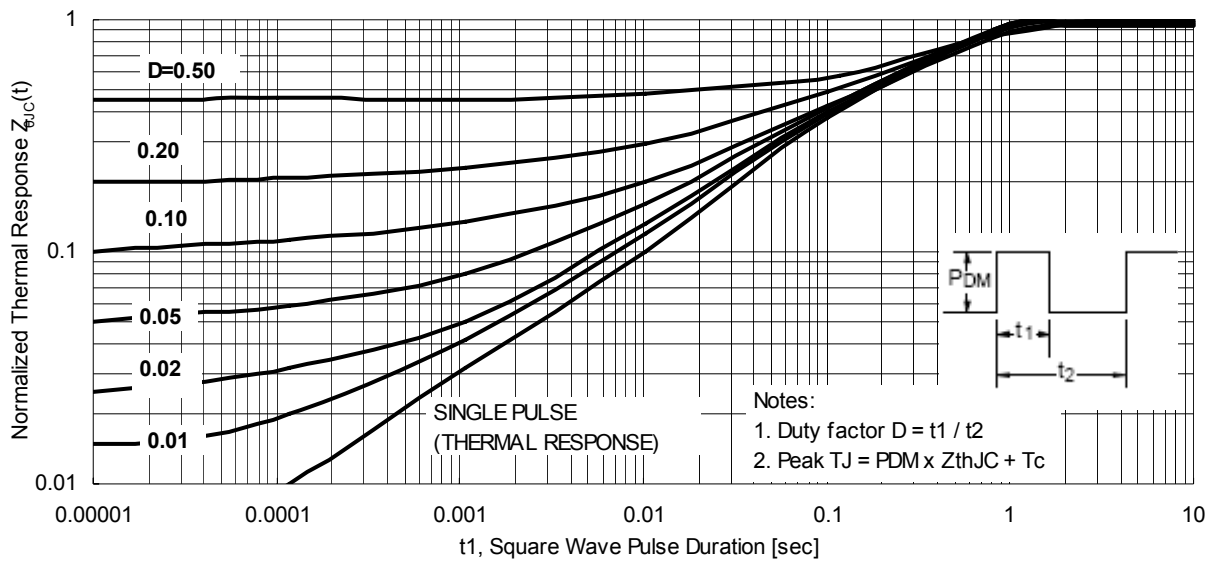
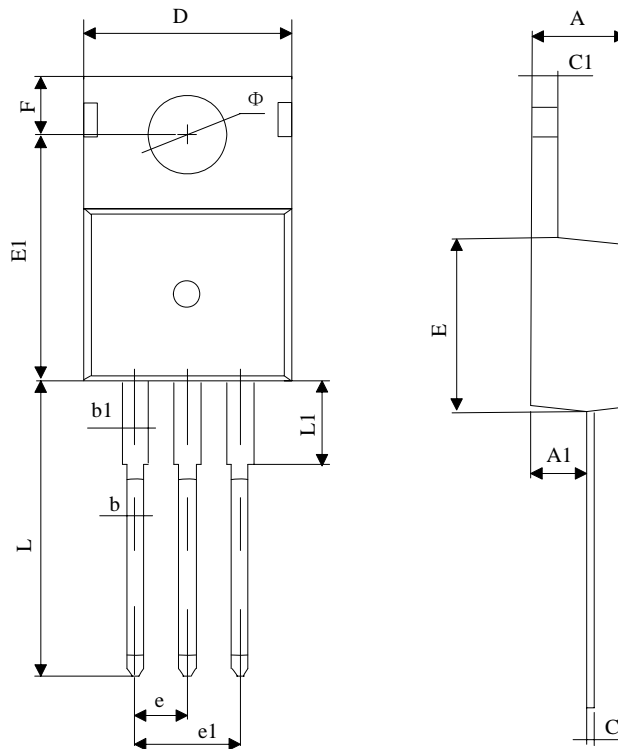

Figure 11 Normalized Maximum Transient Thermal Impedance



Package Drawing



Symbol	Dimensions In Millimeters		Dimensions In Inches	
	Min	Max	Min	Max
A	4.45	4.55	0.175	0.179
A1	2.38	2.42	0.093	0.095
b	0.70	0.90	0.028	0.035
b1	1.42	1.62	0.056	0.064
c	0.45	0.55	0.018	0.022
c1	1.25	1.35	0.049	0.053
D	9.85	9.95	0.388	0.392
E	9.11	9.29	0.359	0.366
E1	12.85	12.95	0.506	0.510
e	2.540TYP		0.100TYP	
e1	5.04	5.12	0.198	0.202
F	2.77	2.83	0.109	0.111
L	12.98	13.18	0.511	0.519
L1	2.97	3.03	0.117	0.119
Φ	3.58	3.62	0.141	0.143



RESTRICTIONS ON PRODUCT USE

- The information contained herein is subject to change without notice.
- BYD Microelectronics Co., Ltd. (short for BME) exerts the greatest possible effort to ensure high quality and reliability. Nevertheless, semiconductor devices in general can malfunction or fail due to their inherent electrical sensitivity and vulnerability to physical stress. It is the responsibility of the buyer, when utilizing BME products, to comply with the standards of safety in making a safe design for the entire system, including redundancy, fire-prevention measures, and malfunction prevention, to prevent any accidents, fires, or community damage that may ensue. In developing your designs, please ensure that BME products are used within specified operating ranges as set forth in the most recent BME products specifications.
- The BME products listed in this document are intended for usage in general electronics applications (personal equipment, office equipment, domestic appliances, etc.). These BME products are neither intended nor warranted for usage in equipment that requires extraordinarily high quality and/or reliability or a malfunction or failure of which may cause loss of human life or bodily injury (“Unintended Usage”). Unintended Usage include atomic energy control instruments, airplane or spaceship instruments, transportation instruments, traffic signal instruments, combustion control instruments, medical instruments, all types of safety devices, etc.. Unintended Usage of BME products listed in this document shall be made at the customer’s own risk.
- BME is not responsible for any problems caused by circuits or diagrams described herein whose related industrial properties, patents, or other rights belong to third parties. The application circuit examples explain typical applications of the products, and do not guarantee the success of any specific mass-production design.