

NPN Silicon RF Transistor

- For low-power amplifiers in mobile communication systems (pager) at collector currents from 0.2mA to 2.5mA
- $f_T = 7\text{GHz}$
F = 2.1dB at 900MHz

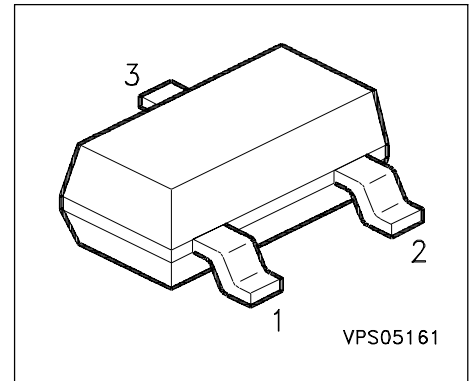

ESD: Electrostatic discharge sensitive device, observe handling precaution!

Type	Marking	Ordering Code	Pin Configuration			Package
BFR 180	RDs	Q62702-F1296	1 = B	2 = E	3 = C	SOT-23

Maximum Ratings

Parameter	Symbol	Values	Unit
Collector-emitter voltage	V_{CEO}	8	V
Collector-emitter voltage	V_{CES}	10	
Collector-base voltage	V_{CBO}	10	
Emitter-base voltage	V_{EBO}	2	
Collector current	I_C	4	mA
Base current	I_B	0.5	
Total power dissipation $T_S \leq 127\text{ °C}$	P_{tot}	30	mW
Junction temperature	T_j	150	
Ambient temperature	T_A	- 65 ... + 150	
Storage temperature	T_{stg}	- 65 ... + 150	

Thermal Resistance

Junction - soldering point ¹⁾	R_{thJS}	≤ 780	K/W
--	------------	------------	-----

1) T_S is measured on the collector lead at the soldering point to the pcb.

Electrical Characteristics at $T_A = 25^\circ\text{C}$, unless otherwise specified.

Parameter	Symbol	Values			Unit
		min.	typ.	max.	
DC Characteristics					
Collector-emitter breakdown voltage $I_C = 1 \text{ mA}, I_B = 0$	$V_{(BR)CEO}$	8	-	-	V
Collector-emitter cutoff current $V_{CE} = 10 \text{ V}, V_{BE} = 0$	I_{CES}	-	-	100	μA
Collector-base cutoff current $V_{CB} = 8 \text{ V}, I_E = 0$	I_{CBO}	-	-	100	nA
Emitter-base cutoff current $V_{EB} = 1 \text{ V}, I_C = 0$	I_{EBO}	-	-	1	μA
DC current gain $I_C = 1 \text{ mA}, V_{CE} = 5 \text{ V}$	h_{FE}	30	100	200	-

Electrical Characteristics at $T_A = 25^\circ\text{C}$, unless otherwise specified.

Parameter	Symbol	Values			Unit
		min.	typ.	max.	
AC Characteristics					
Transition frequency $I_C = 3 \text{ mA}, V_{CE} = 5 \text{ V}, f = 500 \text{ MHz}$	f_T	5	7	-	GHz
Collector-base capacitance $V_{CB} = 5 \text{ V}, f = 1 \text{ MHz}$	C_{cb}	-	0.25	0.4	pF
Collector-emitter capacitance $V_{CE} = 5 \text{ V}, f = 1 \text{ MHz}$	C_{ce}	-	0.18	-	
Emitter-base capacitance $V_{EB} = 0.5 \text{ V}, f = 1 \text{ MHz}$	C_{eb}	-	0.1	-	
Noise figure $I_C = 1 \text{ mA}, V_{CE} = 5 \text{ V}, Z_S = Z_{Sopt}$ $f = 900 \text{ MHz}$ $f = 1.8 \text{ GHz}$	F	-	2.1 2.25	-	dB
Power gain ¹⁾ $I_C = 1 \text{ mA}, V_{CE} = 5 \text{ V}, Z_S = Z_{Sopt}$ $Z_L = Z_{Lopt}$ $f = 900 \text{ MHz}$ $f = 1.8 \text{ GHz}$	G_{ms}	-	13.5 10.5	-	
Transducer gain $I_C = 1 \text{ mA}, V_{CE} = 5 \text{ V}, Z_S = Z_L = 50 \Omega$ $f = 900 \text{ MHz}$ $f = 1.8 \text{ GHz}$	$ S_{21e} ^2$	-	8 5.5	-	

1) $G_{ms} = |S_{21}/S_{12}|$

SPICE Parameters (Gummel-Poon Model, Berkeley-SPICE 2G.6 Syntax) :

Transistor Chip Data

IS =	0.18519	fA	BF =	94.687	-	NF =	1.0236	-
VAF =	26.867	V	IKF =	0.025252	A	ISE =	130.93	fA
NE =	1.9818	-	BR =	20.325	-	NR =	0.93013	-
VAR =	3.2134	V	IKR =	0.012138	A	ISC =	6.1852	fA
NC =	1.6195	-	RB =	1.4255	Ω	IRB =	0.01	mA
RBM =	60	Ω	RE =	3.7045	Ω	RC =	0.56	Ω
CJE =	3.2473	fF	VJE =	1.1812	V	MJE =	0.41827	-
TF =	14.866	ps	XTF =	0.3062	-	VTF =	0.22023	V
ITF =	1.0202	mA	PTF =	0	deg	CJC =	183.69	fF
VJC =	1.1812	V	MJC =	0.30423	-	XCJC =	0.08334	-
TR =	2.2648	ns	CJS =	0	fF	VJS =	0.75	V
MJS =	0	-	XTB =	0	-	EG =	1.11	eV
XTI =	3	-	FC =	0.87906	-	TNOM	300	K

All parameters are ready to use, no scaling is necessary.

Extracted on behalf of SIEMENS Small Signal Semiconductors by:

Institut für Mobil-und Satellitenfunktechnik (IMST)

© 1996 SIEMENS AG

Package Equivalent Circuit:

LBI =	0.85	nH
LBO =	0.51	nH
LEI =	0.69	nH
LEO =	0.61	nH
LCI =	0	nH
LCO =	0.49	nH
CBE =	73	fF
CCB =	84	fF
CCE =	165	fF

EHA07222

Valid up to 6 GHz

For examples and ready to use parameters please contact your local Siemens distributor or sales office to obtain a Siemens CD-ROM or see Internet: <http://www.siemens.de/Semiconductor/products/35/35.htm>

Total power dissipation $P_{tot} = f(T_A^*, T_S)$

* Package mounted on epoxy

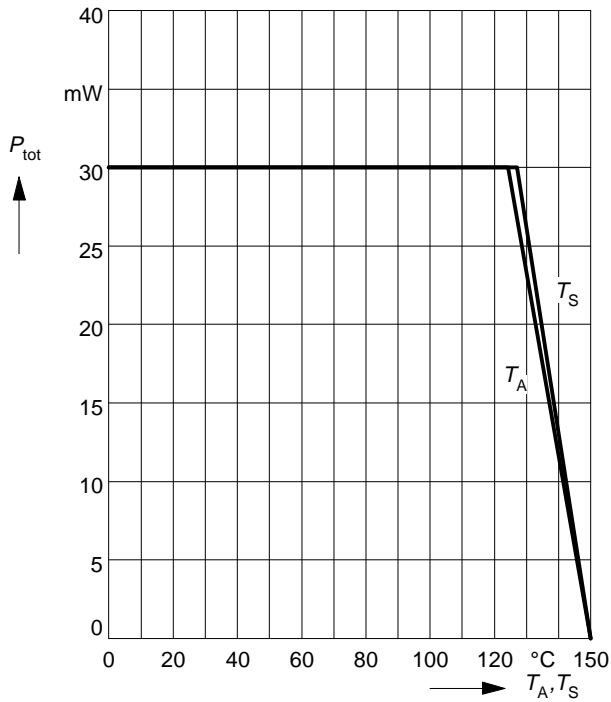

Permissible Pulse Load $R_{thJS} = f(t_p)$

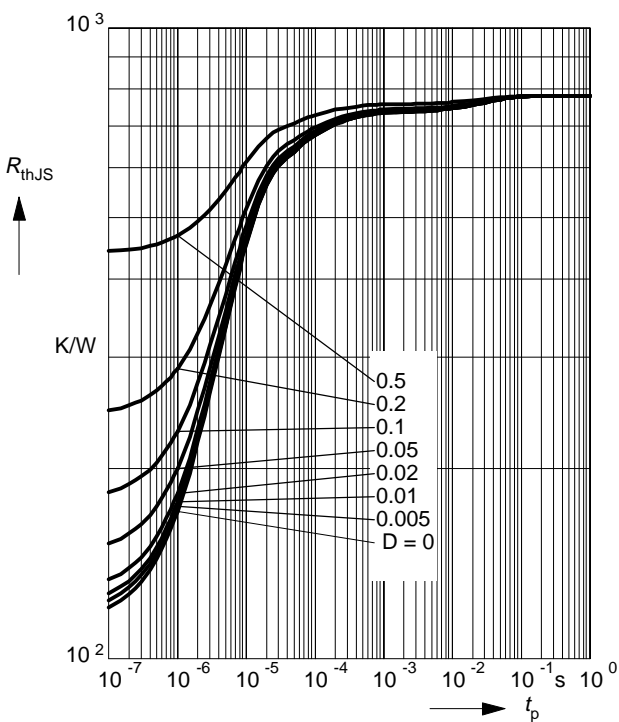

Permissible Pulse Load $P_{totmax}/P_{totDC} = f(t_p)$

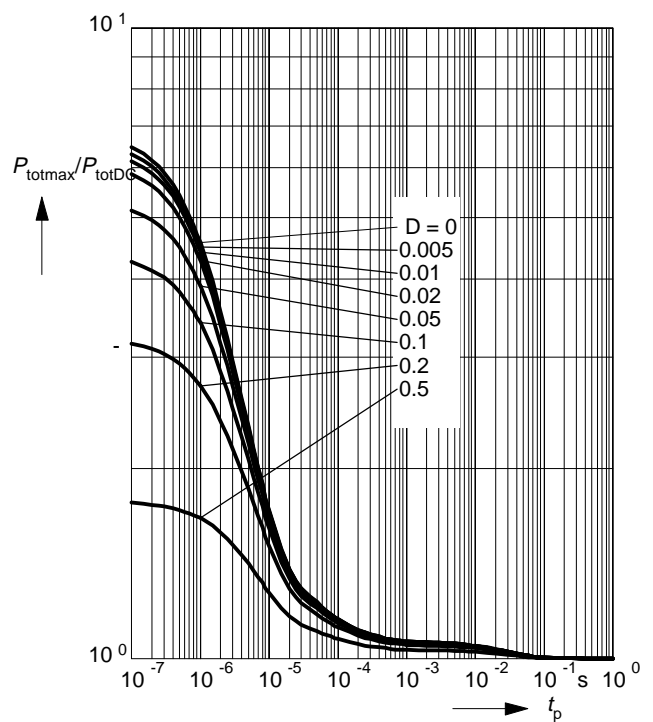

Collector-base capacitance $C_{cb} = f(V_{CB})$

$V_{BE} = v_{be} = 0, f = 1\text{MHz}$

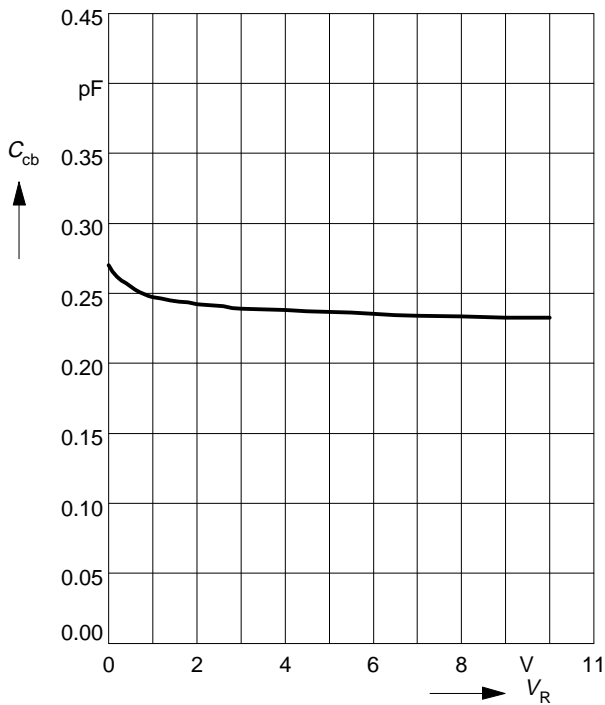

Transition frequency $f_T = f(I_C)$

$V_{CE} = \text{Parameter}$

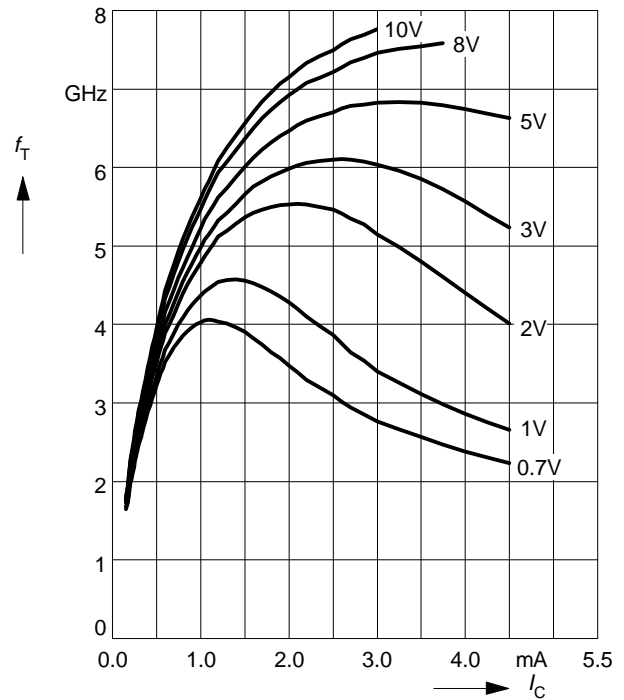

Power Gain $G_{ma}, G_{ms} = f(I_C)$

$f = 0.9\text{GHz}$

$V_{CE} = \text{Parameter}$

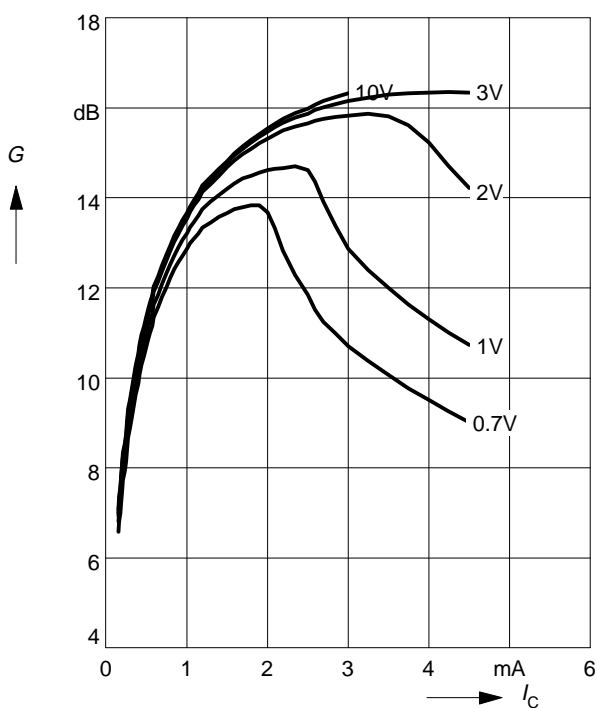

Power Gain $G_{ma}, G_{ms} = f(I_C)$

$f = 1.8\text{GHz}$

$V_{CE} = \text{Parameter}$

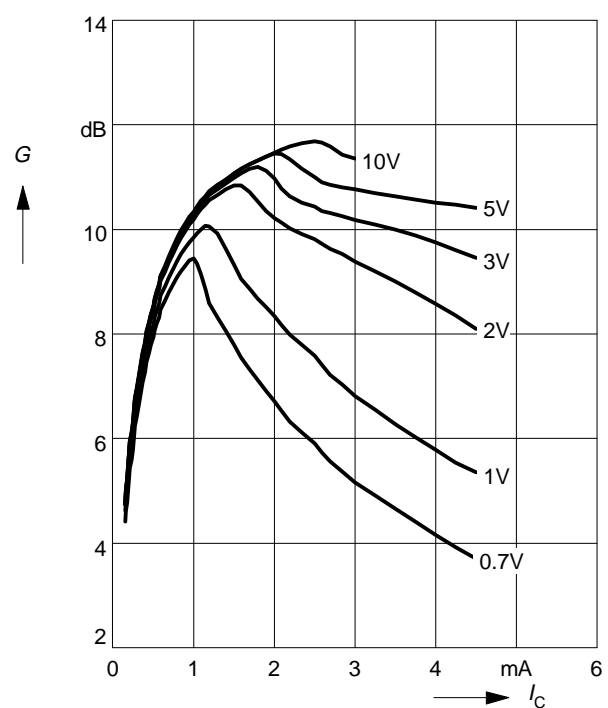

Power Gain $G_{ma}, G_{ms} = f(V_{CE})$: _____
 $|S_{21}|^2 = f(V_{CE})$: - - - - -

f = Parameter

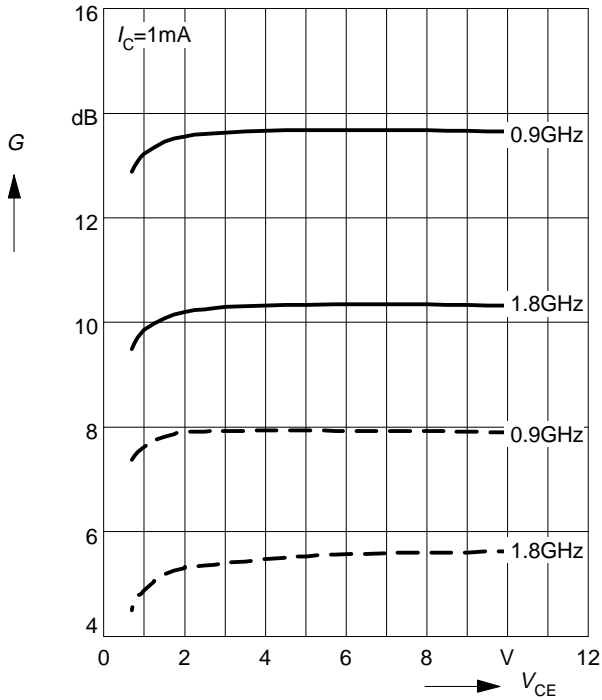

Intermodulation Intercept Point $IP_3 = f(I_C)$
 (3rd order, Output, $Z_S = Z_L = 50\Omega$)

V_{CE} = Parameter, $f = 900\text{MHz}$

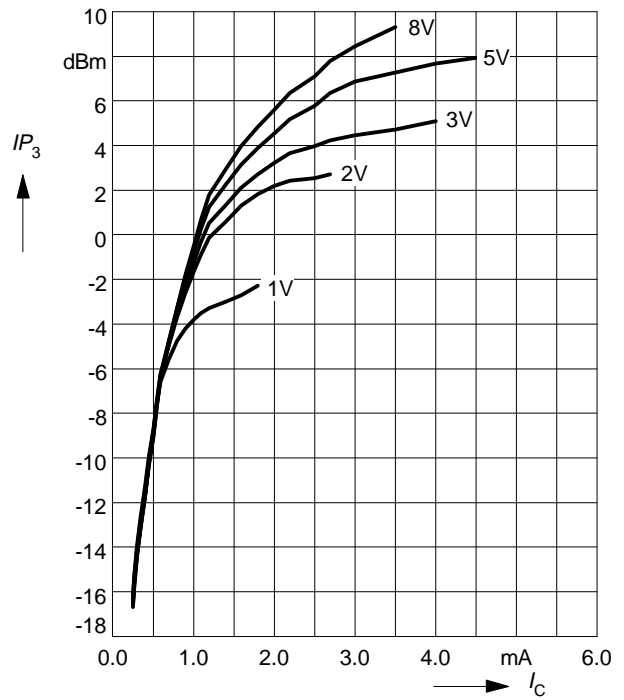

Power Gain $G_{ma}, G_{ms} = f(f)$

V_{CE} = Parameter

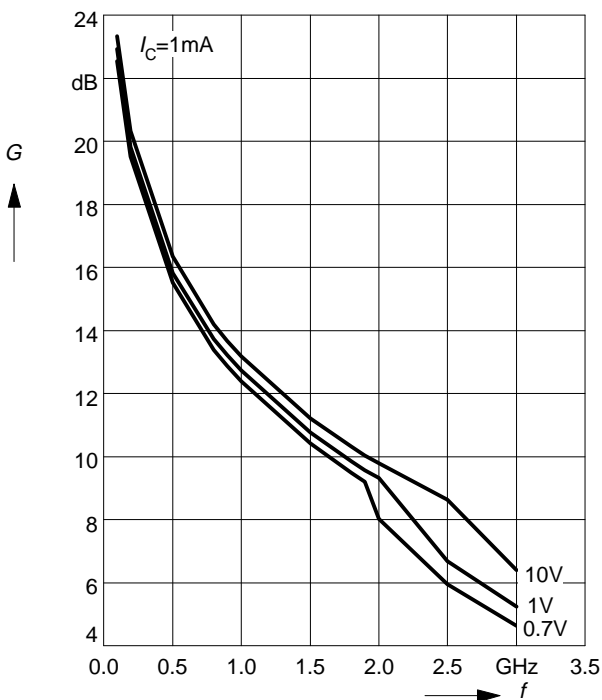

Power Gain $|S_{21}|^2 = f(f)$

V_{CE} = Parameter

