

## NPN Silicon RF Transistor

**BFR 93P**

- For low-distortion broadband amplifiers up to 1 GHz at collector currents from 2 mA to 30 mA.
- CECC-type available: CECC 50002/256.

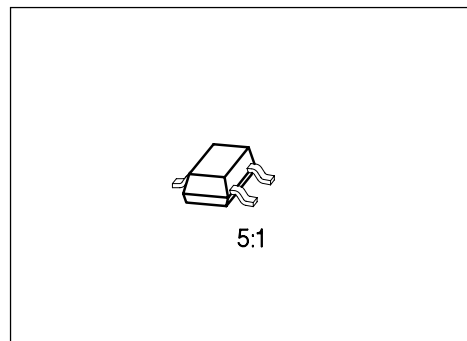

**ESD: Electrostatic discharge sensitive device, observe handling precautions!**

Type	Marking	Ordering Code (tape and reel)	Pin Configuration			Package <sup>1)</sup>
			1	2	3	
BFR 93P	GG	Q62702-F1051	B	E	C	SOT-23

### Maximum Ratings

Parameter	Symbol	Values	Unit
Collector-emitter voltage	$V_{CE0}$	15	V
Collector-base voltage	$V_{CB0}$	20	
Emitter-base voltage	$V_{EB0}$	2.5	
Collector current	$I_C$	50	mA
Base current	$I_B$	10	
Total power dissipation, $T_s \leq 65 \text{ }^\circ\text{C}^3)$	$P_{tot}$	280	mW
Junction temperature	$T_j$	150	$^\circ\text{C}$
Ambient temperature range	$T_A$	- 65 ... + 150	
Storage temperature range	$T_{stg}$	- 65 ... + 150	

### Thermal Resistance

Junction - ambient <sup>2)</sup>	$R_{th JA}$	$\leq 385$	K/W
Junction - soldering point <sup>3)</sup>	$R_{th JS}$	$\leq 305$	

1) For detailed information see chapter Package Outlines.

2) Package mounted on alumina 15 mm × 16.7 mm × 0.7 mm.

3)  $T_s$  is measured on the collector lead at the soldering point to the pcb.

## Electrical Characteristics

at  $T_A = 25\text{ }^\circ\text{C}$ , unless otherwise specified.

Parameter	Symbol	Values			Unit
		min.	typ.	max.	

## DC Characteristics

Collector-emitter breakdown voltage $I_C = 1\text{ mA}, I_B = 0$	$V_{(BR)CE0}$	15	–	–	V
Collector-base cutoff current $V_{CB} = 10\text{ V}, I_E = 0$ $V_{CB} = 20\text{ V}, I_E = 0$	$I_{CB0}$	– –	– –	0.05 10	$\mu\text{A}$
Emitter-base cutoff current $V_{EB} = 2.5\text{ V}, I_C = 0$	$I_{EB0}$	–	–	100	
DC current gain $I_C = 25\text{ mA}, V_{CE} = 5\text{ V}$	$h_{FE}$	30	100	–	–
Collector-emitter saturation voltage $I_C = 50\text{ mA}, I_B = 5\text{ mA}$	$V_{CEsat}$	–	0.2	0.5	V

## Electrical Characteristics

at  $T_A = 25\text{ }^\circ\text{C}$ , unless otherwise specified.

Parameter	Symbol	Values			Unit
		min.	typ.	max.	

## AC Characteristics

Transition frequency $I_C = 30\text{ mA}$ , $V_{CE} = 5\text{ V}$ , $f = 200\text{ MHz}$ $I_C = 50\text{ mA}$ , $V_{CE} = 5\text{ V}$ , $f = 200\text{ MHz}$	$f_t$	–	5 4.7	–	GHz
Collector-base capacitance $V_{CB} = 10\text{ V}$ , $V_{BE} = v_{be} = 0$ , $f = 1\text{ MHz}$	$C_{cb}$	–	0.6	0.75	pF
Collector-emitter capacitance $V_{CE} = 10\text{ V}$ , $V_{BE} = v_{be} = 0$ , $f = 1\text{ MHz}$	$C_{ce}$	–	0.28	–	
Input capacitance $V_{EB} = 0.5\text{ V}$ , $I_C = i_c = 0$ , $f = 1\text{ MHz}$	$C_{ibo}$	–	2.1	–	
Output capacitance $V_{CE} = 10\text{ V}$ , $V_{BE} = v_{be} = 0$ , $f = 1\text{ MHz}$	$C_{obs}$	–	0.9	–	
Noise figure $I_C = 10\text{ mA}$ , $V_{CE} = 8\text{ V}$ , $f = 10\text{ MHz}$ , $Z_S = 75\text{ }\Omega$ $I_C = 5\text{ mA}$ , $V_{CE} = 8\text{ V}$ , $f = 500\text{ MHz}$ , $Z_S = Z_{Sopt}$ $I_C = 10\text{ mA}$ , $V_{CE} = 8\text{ V}$ , $f = 800\text{ MHz}$ , $Z_S = 50\text{ }\Omega$	$F$	–	1.7 1.9 2.4	–	dB
Power gain $I_C = 25\text{ mA}$ , $V_{CE} = 8\text{ V}$ , $f = 800\text{ MHz}$ , $Z_S = Z_{Sopt}$ , $Z_L = Z_{Lopt}$	$G_{pe}$	–	13	–	
Transducer gain $I_C = 25\text{ mA}$ , $V_{CE} = 8\text{ V}$ , $f = 500\text{ MHz}$ , $Z_0 = 50\text{ }\Omega$	$ S_{21e} ^2$	–	15.8	–	
Linear output voltage two-tone intermodulation test $I_C = 25\text{ mA}$ , $V_{CE} = 8\text{ V}$ , $d_{IM} = 60\text{ dB}$ , $f_1 = 806\text{ MHz}$ , $f_2 = 810\text{ MHz}$ , $Z_S = Z_L = 50\text{ }\Omega$	$V_{o1} = V_{o2}$	–	240	–	mV
Third order intercept point $I_C = 25\text{ mA}$ , $V_{CE} = 8\text{ V}$ , $f = 800\text{ MHz}$	$IP_3$	–	30.5	–	dBm

### Total power dissipation $P_{tot} = f(T_A^*; T_S)$

\* Package mounted on alumina

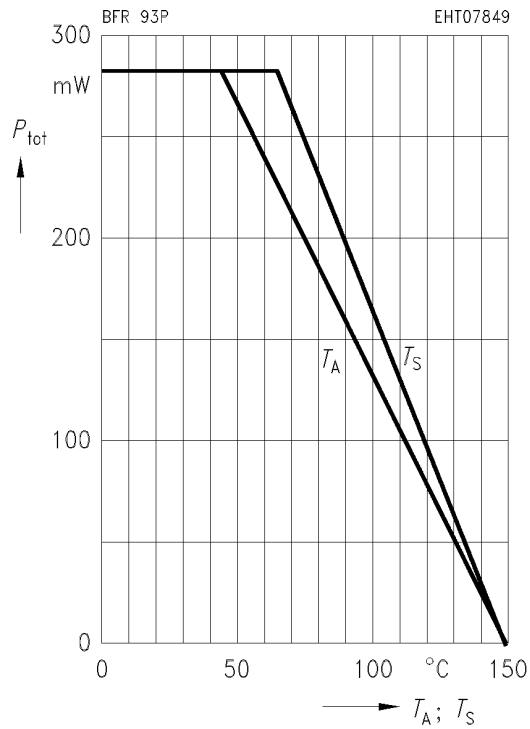

### Transition frequency $f_T = f(I_C)$

$V_{CE} = 5 \text{ V}, f = 200 \text{ MHz}$

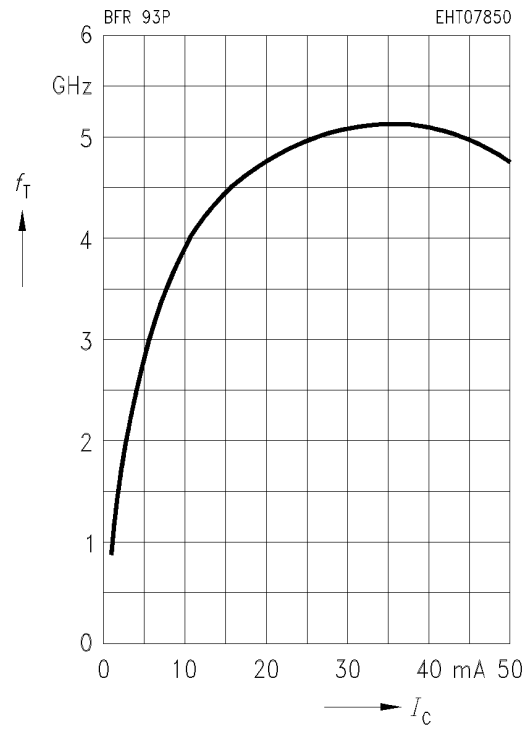

### Collector-base capacitance $C_{cb} = f(V_{CB})$

$V_{BE} = v_{be} = 0, f = 1 \text{ MHz}$

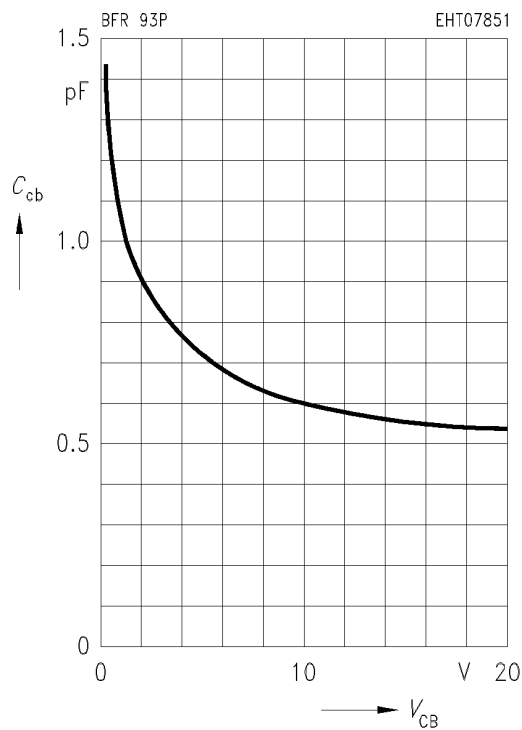

### Common Emitter Noise Parameters

$f$	$F_{\min}$	$G_p(F_{\min})$	$\Gamma_{\text{opt}}$		$R_N$	$N$	$F_{50\Omega}$	$G_p(F_{50\Omega})$
GHz	dB	dB	MAG	ANG	$\Omega$	-	dB	dB

$I_C = 2 \text{ mA}$ ,  $V_{CE} = 8 \text{ V}$ ,  $Z_0 = 50 \Omega$

0.01	1.0	-	$(Z_S = 150 \Omega)$		-	-	1.6	-
------	-----	---	----------------------	--	---	---	-----	---

$I_C = 10 \text{ mA}$ ,  $V_{CE} = 8 \text{ V}$ ,  $Z_0 = 50 \Omega$

0.01	1.5	-	$(Z_S = 90 \Omega)$		-	-	1.7	-
0.8	2.3	-	$(Z_S = Z_{\text{Sopt}})$		-	-	2.4	-

### Noise figure $F = f(Z_S)$

$V_{CE} = 8 \text{ V}$ ,  $f = 10 \text{ MHz}$

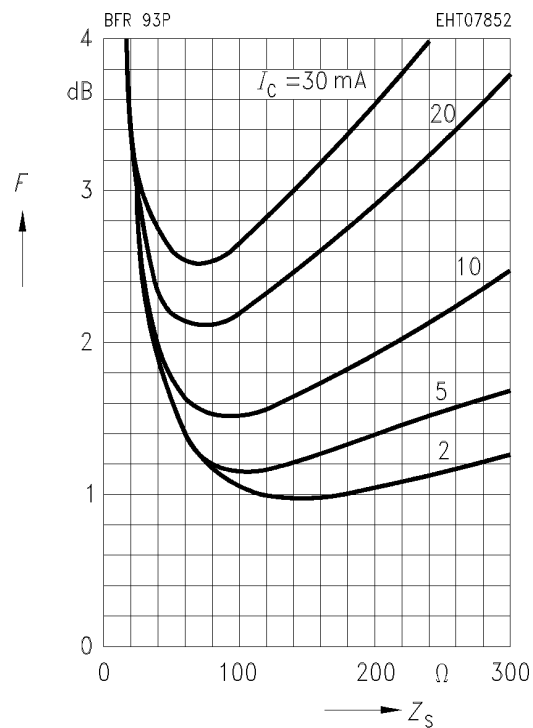

### Noise figure $F = f(I_C)$

$V_{CE} = 8 \text{ V}$ ,  $f = 800 \text{ MHz}$ ,  $Z_{L\text{opt}}(G)$

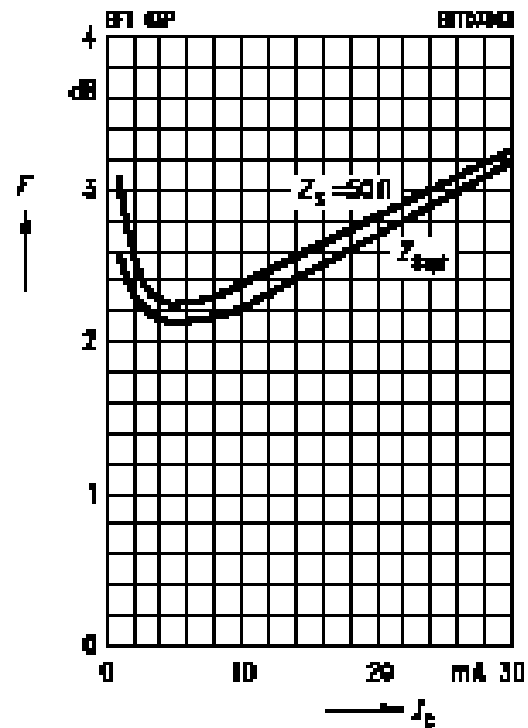

### Common Emitter S Parameters

<i>f</i>	<i>S</i> <sub>11</sub>		<i>S</i> <sub>21</sub>		<i>S</i> <sub>12</sub>		<i>S</i> <sub>22</sub>	
	MAG	ANG	MAG	ANG	MAG	ANG	MAG	ANG

*I*<sub>C</sub> = 5 mA, *V*<sub>CE</sub> = 8 V, *Z*<sub>0</sub> = 50 Ω

0.1	0.74	- 34	12.96	143	0.03	70	0.87	- 14
0.3	0.51	- 92	7.50	113	0.06	55	0.65	- 31
0.5	0.40	- 125	5.13	97	0.08	55	0.54	- 33
0.8	0.32	- 157	3.35	78	0.10	57	0.48	- 32
1.0	0.31	- 171	2.71	72	0.12	59	0.48	- 35
1.2	0.31	177	2.32	65	0.14	60	0.46	- 38
1.4	0.31	166	2.05	59	0.16	62	0.45	- 41
1.6	0.32	156	1.84	52	0.18	61	0.45	- 46
1.8	0.33	146	1.64	47	0.20	61	0.45	- 49
2.0	0.35	137	1.52	42	0.22	61	0.44	- 52

*S*<sub>11</sub>, *S*<sub>22</sub> = *f*(*f*)

*I*<sub>C</sub> = 5 mA, *V*<sub>CE</sub> = 8 V, *Z*<sub>0</sub> = 50 Ω

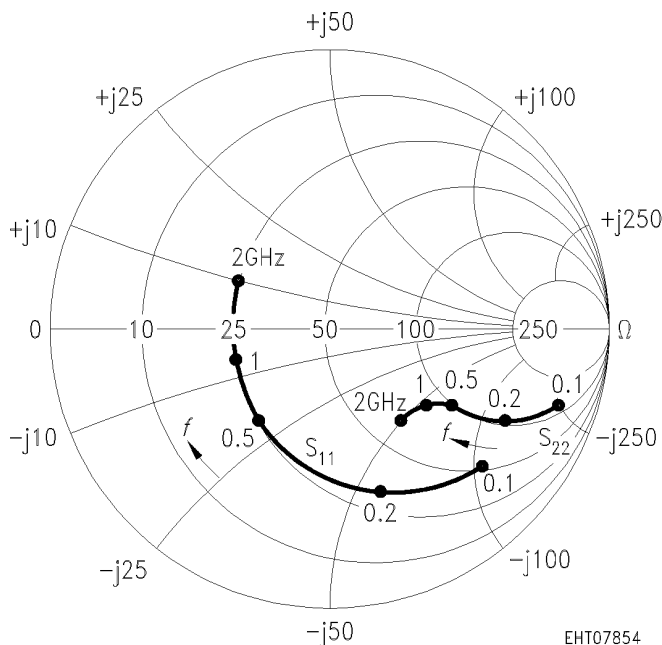

EHT07854

*S*<sub>12</sub>, *S*<sub>21</sub> = *f*(*f*)

*I*<sub>C</sub> = 5 mA, *V*<sub>CE</sub> = 8 V, *Z*<sub>0</sub> = 50 Ω

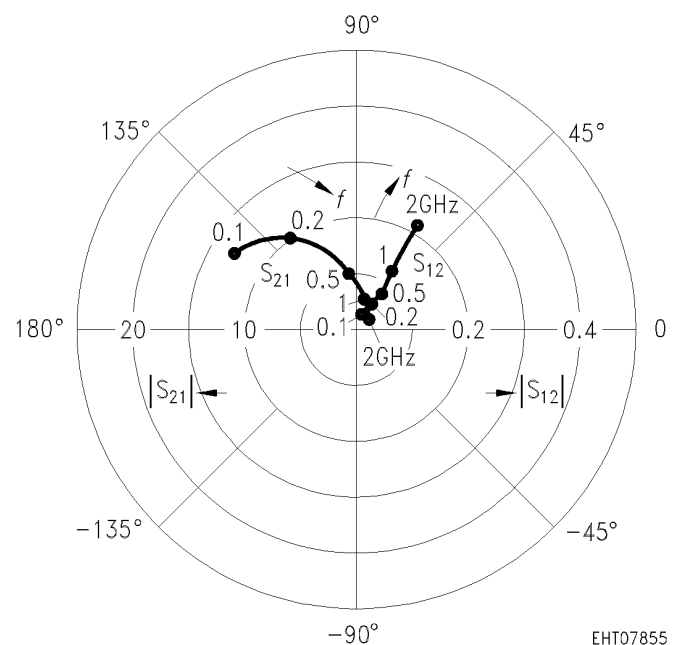

EHT07855

### Common Emitter S Parameters (continued)

<i>f</i>	<i>S</i> <sub>11</sub>		<i>S</i> <sub>21</sub>		<i>S</i> <sub>12</sub>		<i>S</i> <sub>22</sub>	
	MAG	ANG	MAG	ANG	MAG	ANG	MAG	ANG

*I*<sub>C</sub> = 10 mA, *V*<sub>CE</sub> = 8 V, *Z*<sub>0</sub> = 50 Ω

0.1	0.58	- 49	18.73	133	0.03	68	0.77	- 19
0.3	0.37	- 108	9.17	105	0.05	60	0.53	- 32
0.5	0.30	- 139	5.92	90	0.07	63	0.45	- 32
0.8	0.25	- 170	3.85	76	0.10	65	0.41	- 31
1.0	0.25	180	3.09	70	0.13	65	0.40	- 34
1.2	0.26	169	2.63	64	0.15	64	0.39	- 37
1.4	0.26	160	2.33	58	0.17	64	0.38	- 40
1.6	0.28	151	2.07	52	0.20	62	0.38	- 44
1.8	0.29	142	1.84	48	0.22	61	0.38	- 47
2.0	0.31	133	1.72	43	0.24	60	0.36	- 49

*S*<sub>11</sub>, *S*<sub>22</sub> = *f* (*f*)

*I*<sub>C</sub> = 10 mA, *V*<sub>CE</sub> = 8 V, *Z*<sub>0</sub> = 50 Ω

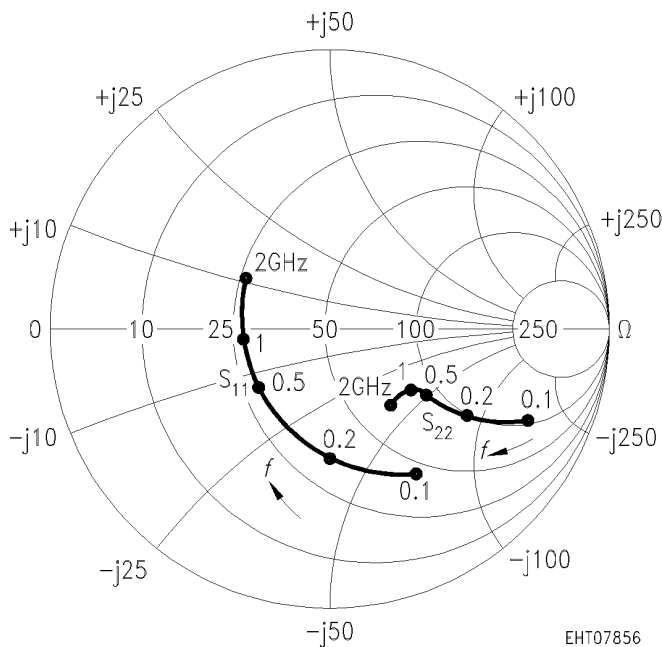

EHT07856

*S*<sub>12</sub>, *S*<sub>21</sub> = *f* (*f*)

*I*<sub>C</sub> = 10 mA, *V*<sub>CE</sub> = 8 V, *Z*<sub>0</sub> = 50 Ω

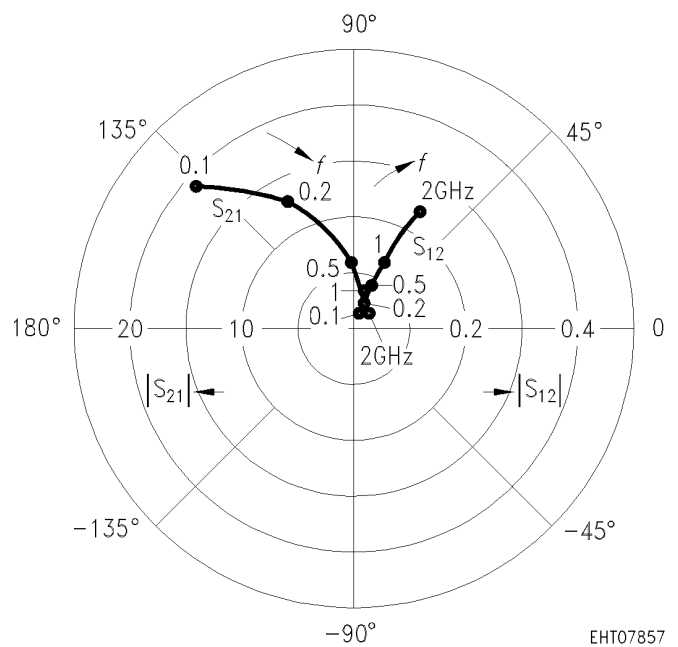

EHT07857

### Common Emitter S Parameters (continued)

<i>f</i>	<i>S</i> <sub>11</sub>		<i>S</i> <sub>21</sub>		<i>S</i> <sub>12</sub>		<i>S</i> <sub>22</sub>	
	MAG	ANG	MAG	ANG	MAG	ANG	MAG	ANG

*I*<sub>C</sub> = 20 mA, *V*<sub>CE</sub> = 8 V, *Z*<sub>0</sub> = 50 Ω

0.1	0.41	- 64	22.91	123	0.02	67	0.67	- 22
0.3	0.28	- 123	9.89	98	0.05	66	0.46	- 30
0.5	0.25	- 151	6.24	86	0.07	68	0.40	- 30
0.8	0.23	- 179	4.03	74	0.11	68	0.37	- 28
1.0	0.23	172	3.22	69	0.13	68	0.37	- 32
1.2	0.25	164	2.74	63	0.16	66	0.35	- 35
1.4	0.25	155	2.41	57	0.18	66	0.35	- 38
1.6	0.27	147	2.14	51	0.20	63	0.35	- 43
1.8	0.28	139	1.92	47	0.23	61	0.35	- 46
2.0	0.30	131	1.79	42	0.25	60	0.33	- 48

*S*<sub>11</sub>, *S*<sub>22</sub> = *f* (*f*)

*I*<sub>C</sub> = 20 mA, *V*<sub>CE</sub> = 8 V, *Z*<sub>0</sub> = 50 Ω

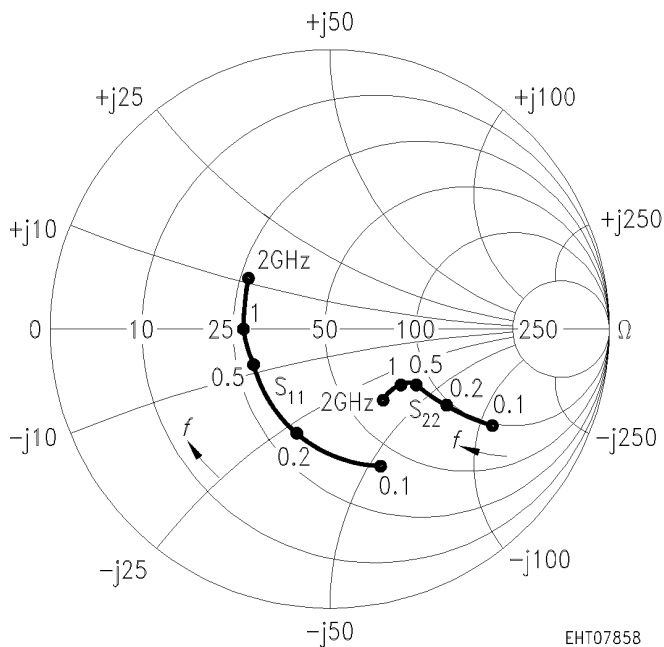

EHT07858

*S*<sub>12</sub>, *S*<sub>21</sub> = *f* (*f*)

*I*<sub>C</sub> = 20 mA, *V*<sub>CE</sub> = 8 V, *Z*<sub>0</sub> = 50 Ω

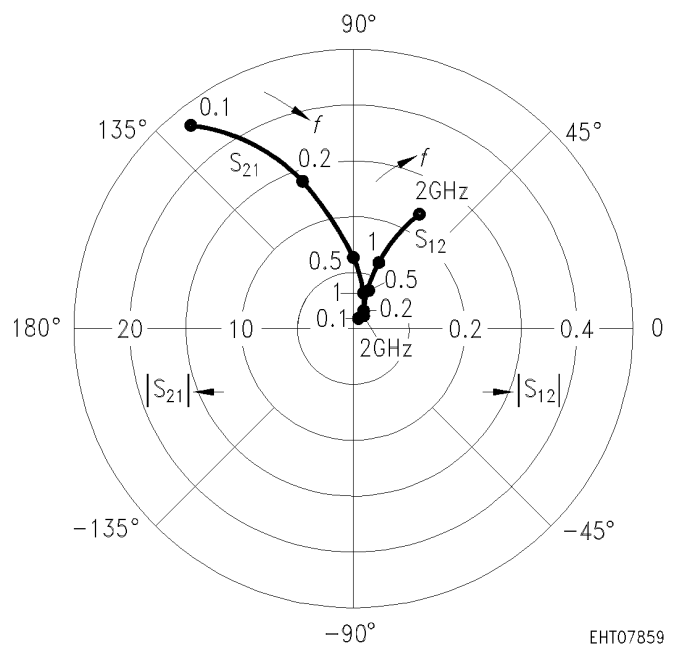

EHT07859



### Common Emitter S Parameters (continued)

<i>f</i>	<i>S</i> <sub>11</sub>		<i>S</i> <sub>21</sub>		<i>S</i> <sub>12</sub>		<i>S</i> <sub>22</sub>	
	MAG	ANG	MAG	ANG	MAG	ANG	MAG	ANG

*I*<sub>C</sub> = 25 mA, *V*<sub>CE</sub> = 8 V, *Z*<sub>0</sub> = 50 Ω

0.1	0.37	- 68	23.71	120	0.02	67	0.64	- 22
0.3	0.26	- 127	9.89	97	0.05	67	0.44	- 29
0.5	0.24	- 154	6.20	85	0.07	70	0.39	- 28
0.8	0.22	179	3.98	73	0.11	69	0.37	- 27
1.0	0.23	170	3.18	68	0.13	68	0.37	- 31
1.2	0.24	162	2.71	62	0.16	66	0.36	- 35
1.4	0.25	153	2.37	57	0.18	66	0.36	- 37
1.6	0.27	146	2.11	51	0.20	63	0.35	- 42
1.8	0.28	138	1.89	47	0.23	62	0.35	- 46
2.0	0.30	130	1.77	42	0.25	60	0.34	- 48

*S*<sub>11</sub>, *S*<sub>22</sub> = *f* (*f*)

*I*<sub>C</sub> = 25 mA, *V*<sub>CE</sub> = 8 V, *Z*<sub>0</sub> = 50 Ω

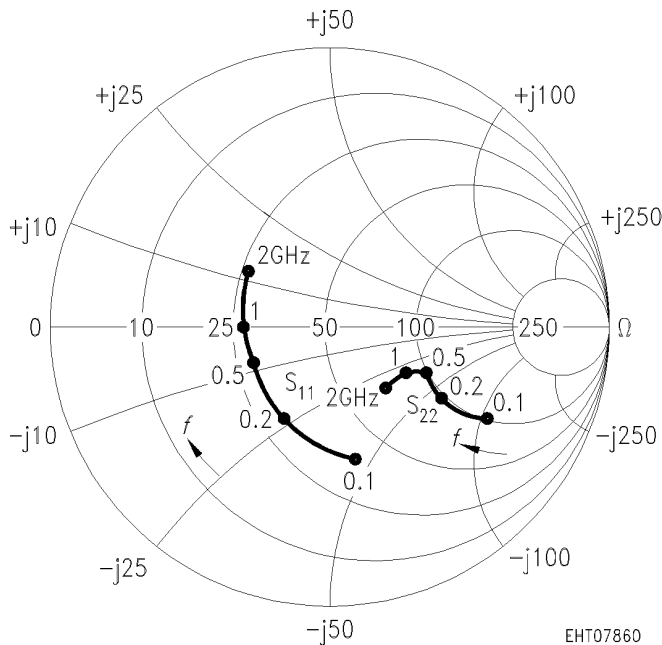

EHT07860

*S*<sub>12</sub>, *S*<sub>21</sub> = *f* (*f*)

*I*<sub>C</sub> = 25 mA, *V*<sub>CE</sub> = 8 V, *Z*<sub>0</sub> = 50 Ω

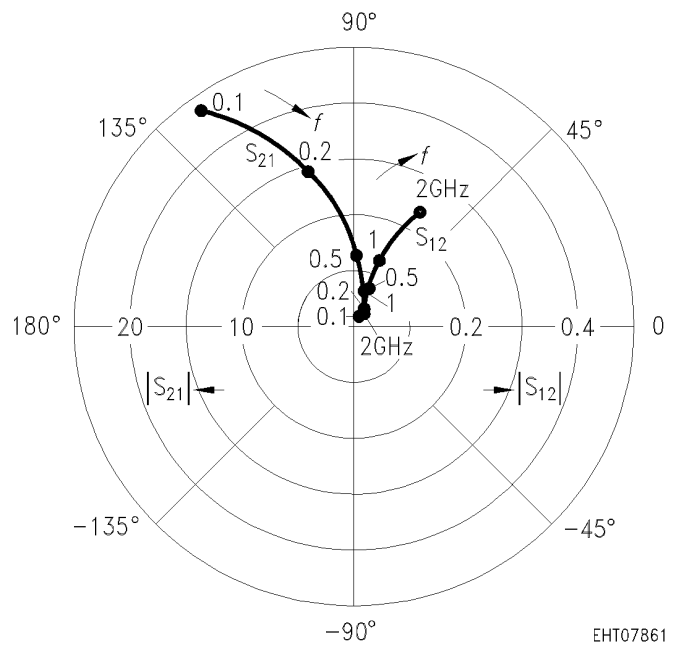

EHT07861