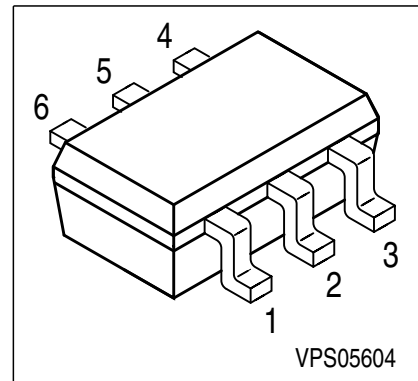
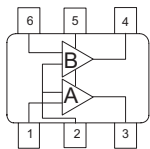
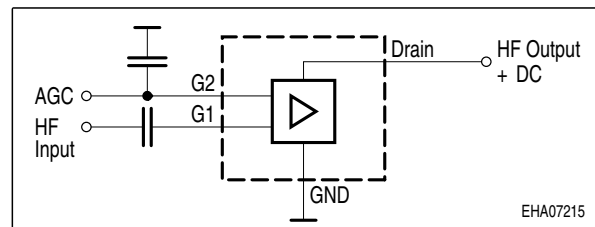
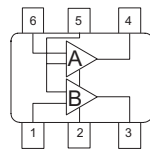

DUAL N-Channel MOSFET Tetrode

- Low noise gain controlled input stages of UHF- and VHF-tuners with 5V supply voltage
- Two AGC amplifiers in one single package
- Integrated stabilized bias network
- Integrated gate protection diodes
- High gain, low noise figure
- Improved cross modulation at gain reduction
- High AGC-range

BG3230

BG3230R

ESD: Electrostatic discharge sensitive device, observe handling precaution!

Type	Package	Pin Configuration						Marking
BG3230	SOT363	1=G1	2=G2	3=D	4=D	5=S	6=G1	KBs
BG3230R	SOT363	1=G1	2=S	3=D	4=D	5=G2	6=G1	KIs

180° rotated tape loading orientation available

Maximum Ratings

Parameter	Symbol	Value	Unit
Drain-source voltage	V_{DS}	8	V
Continuous drain current	I_D	25	mA
Gate 1/ gate 2-source current	$\pm I_{G1/G2SM}$	1	
Gate 1/ gate 2-source voltage	$\pm V_{G1/G2S}$	6	V
Total power dissipation	P_{tot}	160	mW
Storage temperature	T_{stg}	-55 ... 150	°C
Channel temperature	T_{ch}	150	

Thermal Resistance

Parameter	Symbol	Value	Unit
Channel - soldering point ¹⁾	R_{thchs}	≤ 280	K/W

¹⁾For calculation of R_{thJA} please refer to Application Note Thermal Resistance

Electrical Characteristics

Parameter	Symbol	Values			Unit
		min.	typ.	max.	
DC Characteristics					
Drain-source breakdown voltage $I_D = 100 \mu\text{A}$, $V_{G1S} = 0$, $V_{G2S} = 0$	$V_{(BR)DS}$	12	-	-	V
Gate1-source breakdown voltage $+I_{G1S} = 10 \text{ mA}$, $V_{G2S} = 0$, $V_{DS} = 0$	$+V_{(BR)G1SS}$	6	-	15	
Gate2 source breakdown voltage $\pm I_{G2S} = 10 \text{ mA}$, $V_{G1S} = 0$, $V_{DS} = 0$	$\pm V_{(BR)G2SS}$	6	-	15	
Gate1-source leakage current $V_{G1S} = 6 \text{ V}$, $V_{G2S} = 0$	$+I_{G1SS}$	-	-	50	μA
Gate 2 source leakage current $\pm V_{G2S} = 6 \text{ V}$, $V_{G1S} = 0$, $V_{DS} = 0$	$\pm I_{G2SS}$	-	-	50	nA
Drain current $V_{DS} = 5 \text{ V}$, $V_{G1S} = 0$, $V_{G2S} = 4 \text{ V}$	I_{DSS}	-	-	100	μA
Operating current (selfbiased) $V_{DS} = 5 \text{ V}$, $V_{G2S} = 4 \text{ V}$	I_{DSO}	-	13	-	mA
Gate2-source pinch-off voltage $V_{DS} = 5 \text{ V}$, $I_D = 100 \mu\text{A}$	$V_{G2S(p)}$	-	1	-	V

Electrical Characteristics

Parameter	Symbol	Values			Unit
		min.	typ.	max.	
AC Characteristics - (verified by random sampling)					
Forward transconductance $V_{DS} = 5\text{ V}, V_{G2S} = 4\text{ V}$	g_{fs}	-	33	-	mS
Gate1 input capacitance $V_{DS} = 5\text{ V}, V_{G2S} = 4\text{ V}, f = 1\text{ MHz}$	C_{g1ss}	-	1.9	-	pF
Output capacitance $V_{DS} = 5\text{ V}, V_{G2S} = 4\text{ V}, f = 100\text{ MHz}$	C_{dss}	-	1.1	-	
Power gain (self biased) $V_{DS} = 5\text{ V}, V_{G2S} = 4\text{ V}, f = 800\text{ MHz}$ $V_{DS} = 5\text{ V}, V_{G2S} = 4\text{ V}, f = 45\text{ MHz}$	G_p	-	24	-	dB
		-	31	-	
Noise figure (self biased) $V_{DS} = 5\text{ V}, V_{G2S} = 4\text{ V}, f = 800\text{ MHz}$ $V_{DS} = 5\text{ V}, V_{G2S} = 4\text{ V}, f = 45\text{ MHz}$	F	-	1.3	-	dB
		-	1.7	-	
Gain control range $V_{DS} = 5\text{ V}, V_{G2S} = 4...0\text{ V}, f = 800\text{ MHz}$	ΔG_p	45	-	-	
Cross-modulation $k=1\%$, $f_w=50\text{MHz}$, $f_{unw}=60\text{MHz}$ AGC = 0 dB AGC = 10 dB AGC = 40 dB	X_{mod}	90	-	-	-
		-	87	-	
		96	100	-	

Total power dissipation $P_{tot} = f(T_S)$

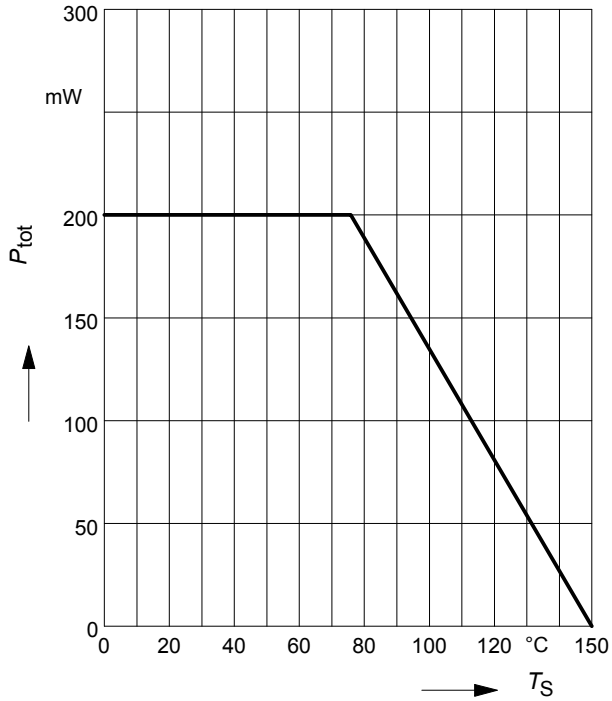

Output characteristics $I_D = f(V_{DS})$

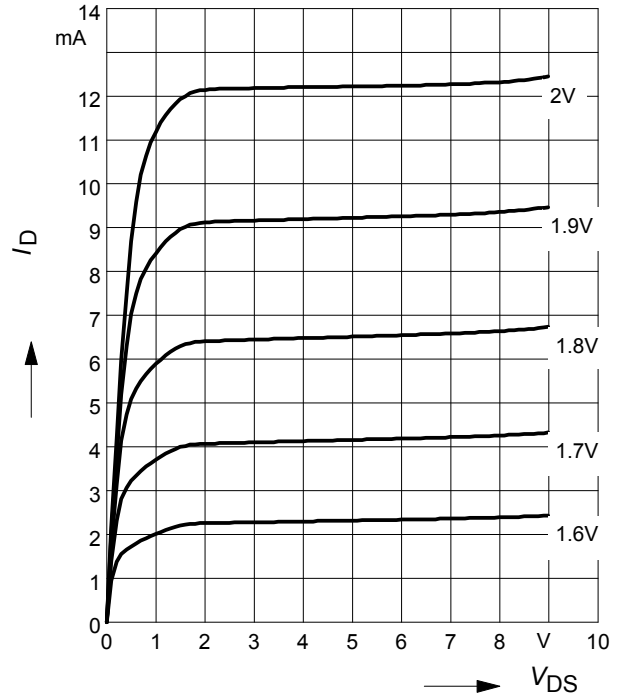

Gate 1 forward transconductance

$g_{fs} = f(I_D)$

$V_{DS} = 5V, V_{G2S} = \text{Parameter}$

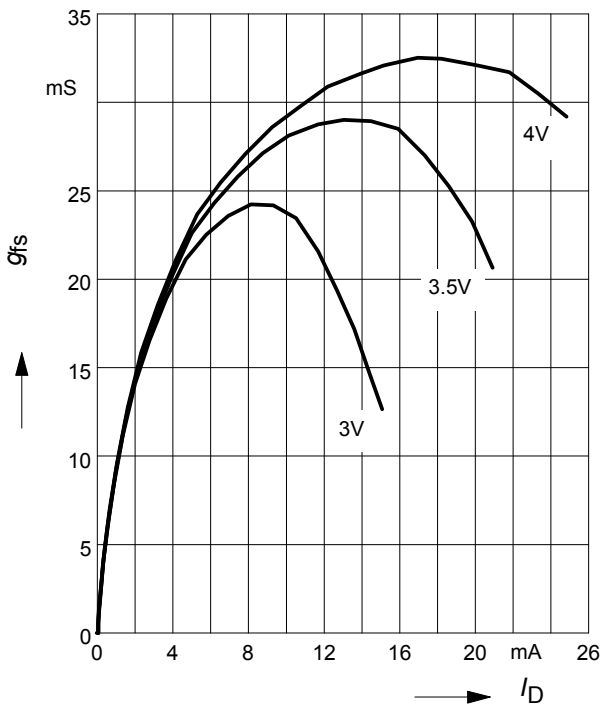

Drain current $I_D = f(V_{G1S})$

$V_{DS} = 5V$

$V_{G2S} = \text{Parameter}$

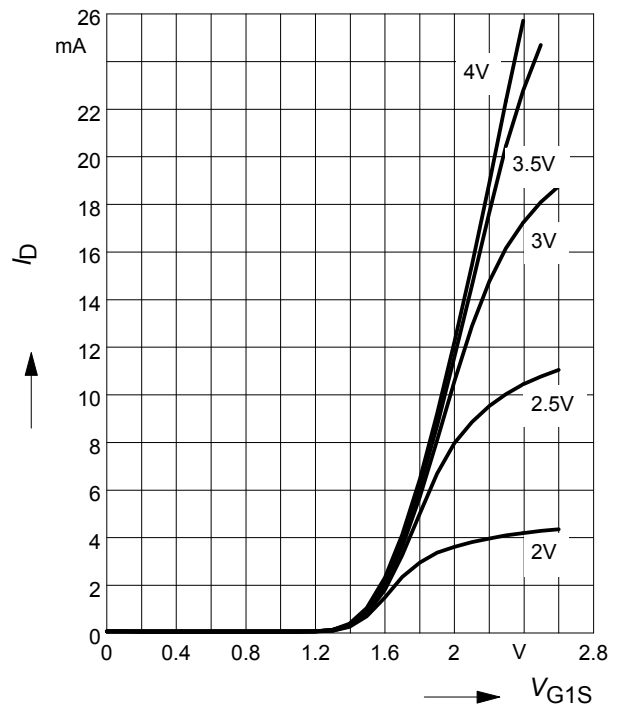

AGC characteristic $AGC = f(V_{G2S})$

$f = 200 \text{ MHz}$

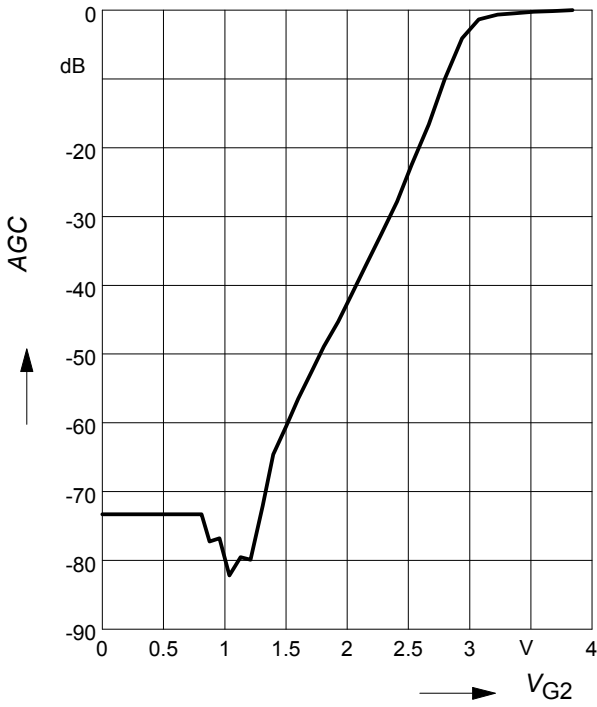

AGC characteristic $AGC = f(V_{G2S})$

$f = 800 \text{ MHz}$

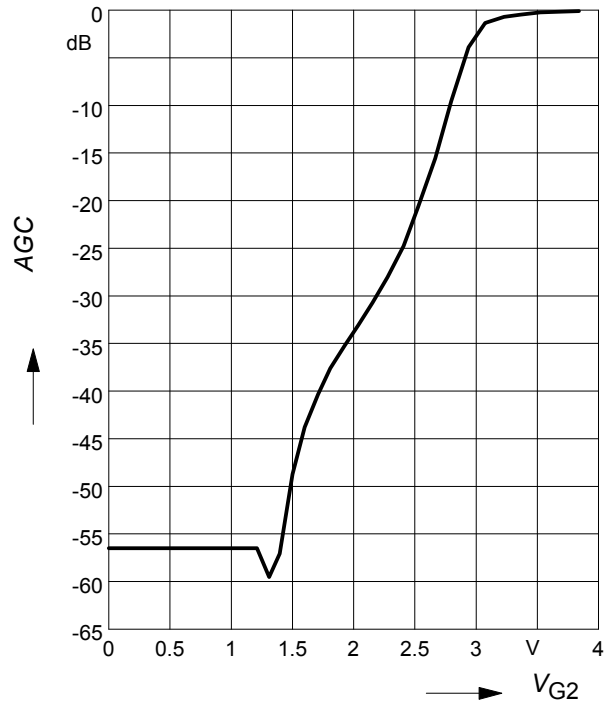

Crossmodulation $V_{unw} = (AGC)$

$V_{DS} = 5 \text{ V}, R_{g1} = 68 \text{ k}\Omega$

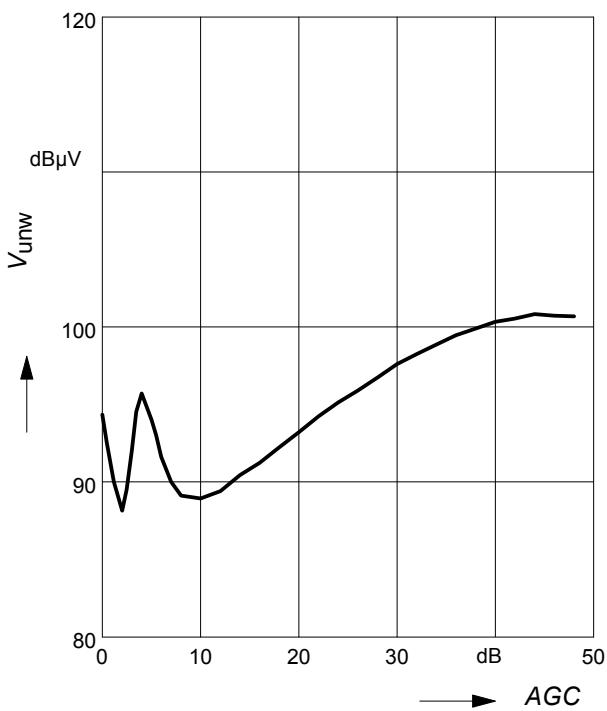

Cossmodulation test circuit

