

BGA7024

400 MHz to 2700 MHz 0.25 W high linearity silicon amplifier

Rev. 01 — 28 May 2010

Product data sheet

1. Product profile

1.1 General description

The BGA7024 MMIC is a one-stage amplifier, available in a low-cost surface-mount package. It delivers 24 dBm output power at 1 dB gain compression and superior performance up to 2700 MHz.

1.2 Features and benefits

- 400 MHz to 2700 MHz frequency operating range
- 16 dB small signal gain at 2 GHz
- 24 dBm output power at 1 dB gain compression
- Integrated active biasing
- External matching allows broad application optimization of the electrical performance
- 5 V single supply operation
- All pins ESD protected

1.3 Applications

- Broadband CPE/MoCA
- WLAN/ISM/RFID
- Wireless infrastructure (base station, repeater, point-to-point backhaul systems)
- Industrial applications
- E-metering
- Satellite Master Antenna TV (SMATV)

1.4 Quick reference data

Table 1. Quick reference data

Input and output impedances matched to 50 Ω . Typical values at $V_{CC} = 5$ V; $T_{case} = 25$ °C; unless otherwise specified.

Symbol	Parameter	Conditions	Min	Typ	Max	Unit
I_{CC}	supply current		95	110	125	mA
f	frequency		[1] 400	-	2700	MHz
G_p	power gain	f = 2140 MHz	13.5	15	16.5	dB
$P_{L(1dB)}$	output power at 1 dB gain compression	f = 2140 MHz	24.0	25.5	-	dBm
IP3 _O	output third-order intercept point	f = 2140 MHz	[2] 35.0	38.5	-	dBm

[1] Operation outside this range is possible but not guaranteed.

[2] $P_L = 11$ dBm per tone; spacing = 1 MHz.



2. Pinning information

Table 2. Pinning

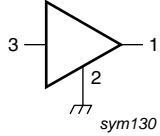
Pin	Description	Simplified outline	Graphic symbol
1	$V_{CC(RF)}$	[1]	
2	GND	[2]	
3	RF_IN	[1]	

[1] This pin is DC-coupled and requires an external DC-blocking capacitor.

[2] The center metal base of the SOT89 also functions as heatsink for the power amplifier.

3. Ordering information

Table 3. Ordering information

Type number	Package		
	Name	Description	Version
BGA7024	-	plastic surface-mounted package; exposed die pad for good heat transfer; 3 leads	SOT89

4. Functional diagram

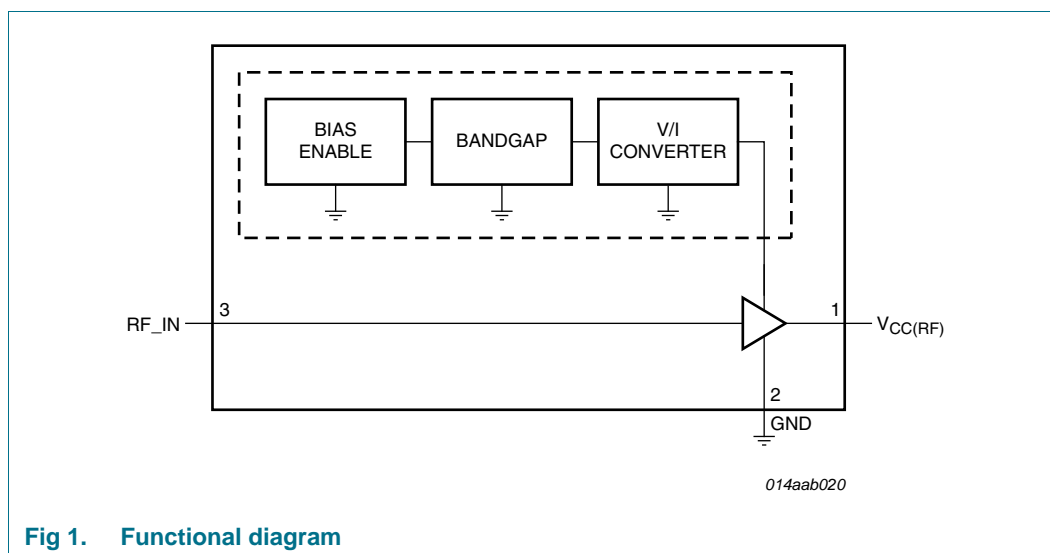

Fig 1. Functional diagram

5. Limiting values

Table 4. Limiting values

In accordance with the Absolute Maximum Rating System (IEC 60134).

Symbol	Parameter	Conditions	Min	Max	Unit
$V_{CC(RF)}$	RF supply voltage		-	5.7	V
$P_{I(RF)}$	RF input power		-	25	dBm
T_{case}	case temperature		-40	+85	°C
T_j	junction temperature		-	150	°C
V_{ESD}	electrostatic discharge voltage	Human Body Model (HBM); according to JEDEC standard 22-A114E	-	2000	V
		Charged Device Model (CDM); according to JEDEC standard 22-C101B	-	500	V

6. Thermal characteristics

Table 5. Thermal characteristics

Symbol	Parameter	Conditions	Typ	Unit
$R_{th(j-c)}$	thermal resistance from junction to case	$T_{case} = 85\text{ °C}$; $V_{CC} = 5\text{ V}$; $I_{CC} = 110\text{ mA}$	38	K/W

7. Static characteristics

Table 6. Characteristics

Input and output impedances matched to 50 Ω . Typical values at $V_{CC} = 5\text{ V}$; $T_{case} = 25\text{ °C}$; unless otherwise specified.

Symbol	Parameter	Conditions	Min	Typ	Max	Unit
V_{CC}	supply voltage		-	5.0	-	V
I_{CC}	supply current		95	110	125	mA

8. Dynamic characteristics

Table 7. Dynamic characteristics

Input and output impedances matched to 50 Ω . Typical values at $V_{CC} = 5\text{ V}$; $T_{case} = 25\text{ °C}$; see [Section 12 "Application information"](#); unless otherwise specified.

Symbol	Parameter	Conditions	Min	Typ	Max	Unit
f	frequency		[1] 400	-	2700	MHz
G_p	power gain	f = 940 MHz	-	22	-	dB
		f = 1960 MHz	-	16	-	dB
		f = 2140 MHz	13.5	15	16.5	dB
		f = 2445 MHz	-	14	-	dB
$P_{L(1dB)}$	output power at 1 dB gain compression	f = 940 MHz	-	24	-	dBm
		f = 1960 MHz	-	25.5	-	dBm
		f = 2140 MHz	24.0	25.5	-	dBm
		f = 2445 MHz	-	24.5	-	dBm

Table 7. Dynamic characteristics ...continued

Input and output impedances matched to 50 Ω . Typical values at $V_{CC} = 5$ V; $T_{case} = 25$ °C; see Section 12 "Application information"; unless otherwise specified.

Symbol	Parameter	Conditions	Min	Typ	Max	Unit
IP _{3O}	output third-order intercept point	f = 940 MHz [2]	-	37.5	-	dBm
		f = 1960 MHz [2]	-	38.0	-	dBm
		f = 2140 MHz [2]	35.0	38.0	-	dBm
		f = 2445 MHz [2]	-	37.5	-	dBm
NF	noise figure	f = 940 MHz [3]	-	2.9	-	dB
		f = 1960 MHz [3]	-	3.7	-	dB
		f = 2140 MHz [3]	-	3.7	-	dB
		f = 2445 MHz [3]	-	4.0	-	dB
RL _{in}	input return loss	f = 940 MHz	-	-9	-	dB
		f = 1960 MHz	-	-10	-	dB
		f = 2140 MHz	-	-10	-	dB
		f = 2445 MHz	-	-14	-	dB
RL _{out}	output return loss	f = 940 MHz	-	-29	-	dB
		f = 1960 MHz	-	-22	-	dB
		f = 2140 MHz	-	-29	-	dB
		f = 2445 MHz	-	-11	-	dB

[1] Operation outside this range is possible but not guaranteed.

[2] P_L = 11 dBm per tone; spacing = 1 MHz.

[3] Defined at P_{i(RF)} = -40 dBm; small signal conditions.

9. Scattering parameters

Table 8. Scattering parameters at 5 V, MMIC only

f (MHz)	S ₁₁		S ₂₁		S ₁₂		S ₂₂	
	Magnitude (ratio)	Angle (degree)	Magnitude (ratio)	Angle (degree)	Magnitude (ratio)	Angle (degree)	Magnitude (ratio)	Angle (degree)
400	0.83	-178.9	14.03	112.7	0.01	35.5	0.53	-166.3
500	0.85	178.7	11.69	104.4	0.01	38.77	0.56	-168.9
600	0.85	176.4	9.93	98.19	0.02	41.13	0.57	-172.2
700	0.86	173.8	8.67	93.04	0.02	43.1	0.58	-174.8
800	0.86	171.1	7.68	88.54	0.02	44.34	0.58	-177.4
900	0.86	168.3	6.9	84.36	0.02	44.96	0.59	179.7
1000	0.86	165.4	6.29	80.24	0.02	45.07	0.60	176.7
1100	0.87	162.7	5.72	76.42	0.02	45	0.60	173.3
1200	0.88	159.9	5.23	72.83	0.02	44.54	0.60	170.9
1300	0.88	157.3	4.80	69.34	0.03	44.17	0.61	168.4
1400	0.89	154.8	4.43	66.17	0.03	43.58	0.61	166.4
1500	0.89	153	4.09	63.33	0.03	43.02	0.62	164.7
1600	0.89	151.3	3.80	60.8	0.03	42.67	0.63	163.1
1700	0.90	149.9	3.54	58.3	0.03	42.36	0.64	162.1

Table 8. Scattering parameters at 5 V, MMIC only ...continued

f (MHz)	S ₁₁		S ₂₁		S ₁₂		S ₂₂	
	Magnitude (ratio)	Angle (degree)	Magnitude (ratio)	Angle (degree)	Magnitude (ratio)	Angle (degree)	Magnitude (ratio)	Angle (degree)
1800	0.90	148.7	3.30	56.13	0.03	41.89	0.65	161.2
1900	0.90	147.9	3.11	54.13	0.03	41.65	0.66	160.8
2000	0.91	147.5	2.93	52.63	0.03	41.7	0.66	160.5
2100	0.90	147	2.78	50.91	0.04	41.61	0.66	160.5
2200	0.90	146.9	2.65	49.5	0.04	41.59	0.67	160.9
2300	0.90	146.6	2.54	48.13	0.04	41.44	0.66	161.6
2400	0.90	146.5	2.46	46.88	0.04	41.61	0.66	161.7
2500	0.89	146.3	2.39	45.39	0.04	41.45	0.66	162.6
2600	0.88	146	2.34	43.93	0.05	41.13	0.65	162.8
2700	0.87	145.4	2.30	42.24	0.05	40.56	0.64	163.2

10. Reliability information

Table 9. Reliability

Life test	Conditions	Intrinsic failure rate
HTOL	according to JESD85; confidence level 60 %; T _j = 55 °C; activation energy = 0.7 eV; acceleration factor according to Arrhenius equation	4

11. Moisture sensitivity

Table 10. Moisture sensitivity level

Test methodology	Class
JESD-22-A113	1

12. Application information

12.1 920 MHz to 960 MHz

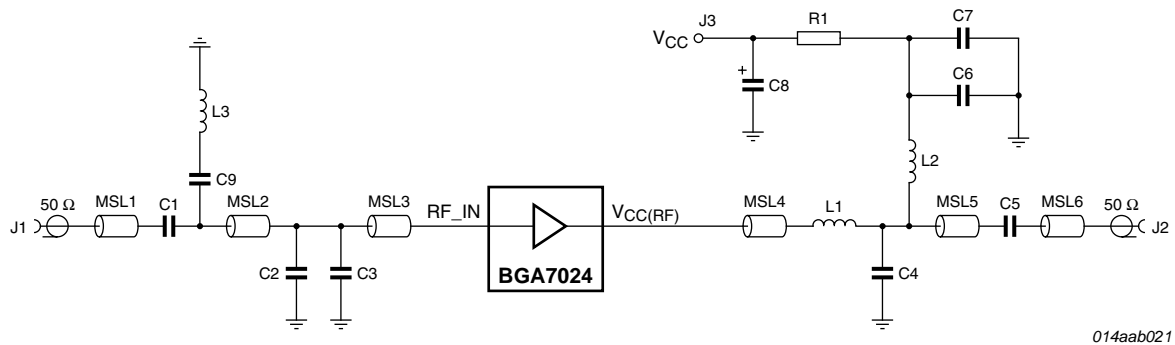

See [Table 11](#) for a list of components.

PCB specification: Rogers RO4003C; height = 0.508 mm; $\epsilon_r = 3.38$; copper thickness = 35 μm .

Fig 2. 5 V application schematic; 920 MHz to 960 MHz

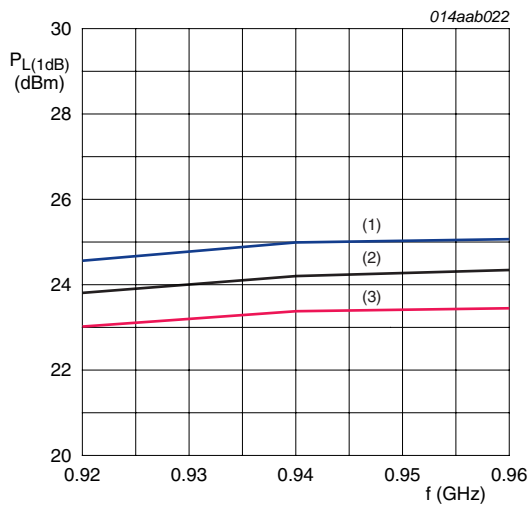

- (1) $T_{\text{case}} = -40\text{ }^{\circ}\text{C}$.
- (2) $T_{\text{case}} = 25\text{ }^{\circ}\text{C}$.
- (3) $T_{\text{case}} = 85\text{ }^{\circ}\text{C}$.

Fig 3. Output power at 1 dB gain compression as a function of frequency

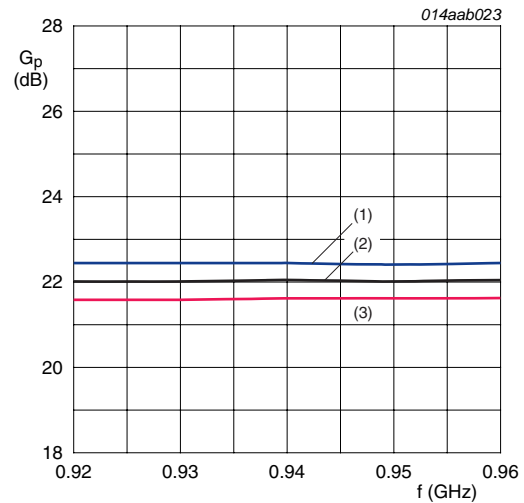

- (1) $T_{\text{case}} = -40\text{ }^{\circ}\text{C}$.
- (2) $T_{\text{case}} = 25\text{ }^{\circ}\text{C}$.
- (3) $T_{\text{case}} = 85\text{ }^{\circ}\text{C}$.

Fig 4. Power gain as a function of frequency

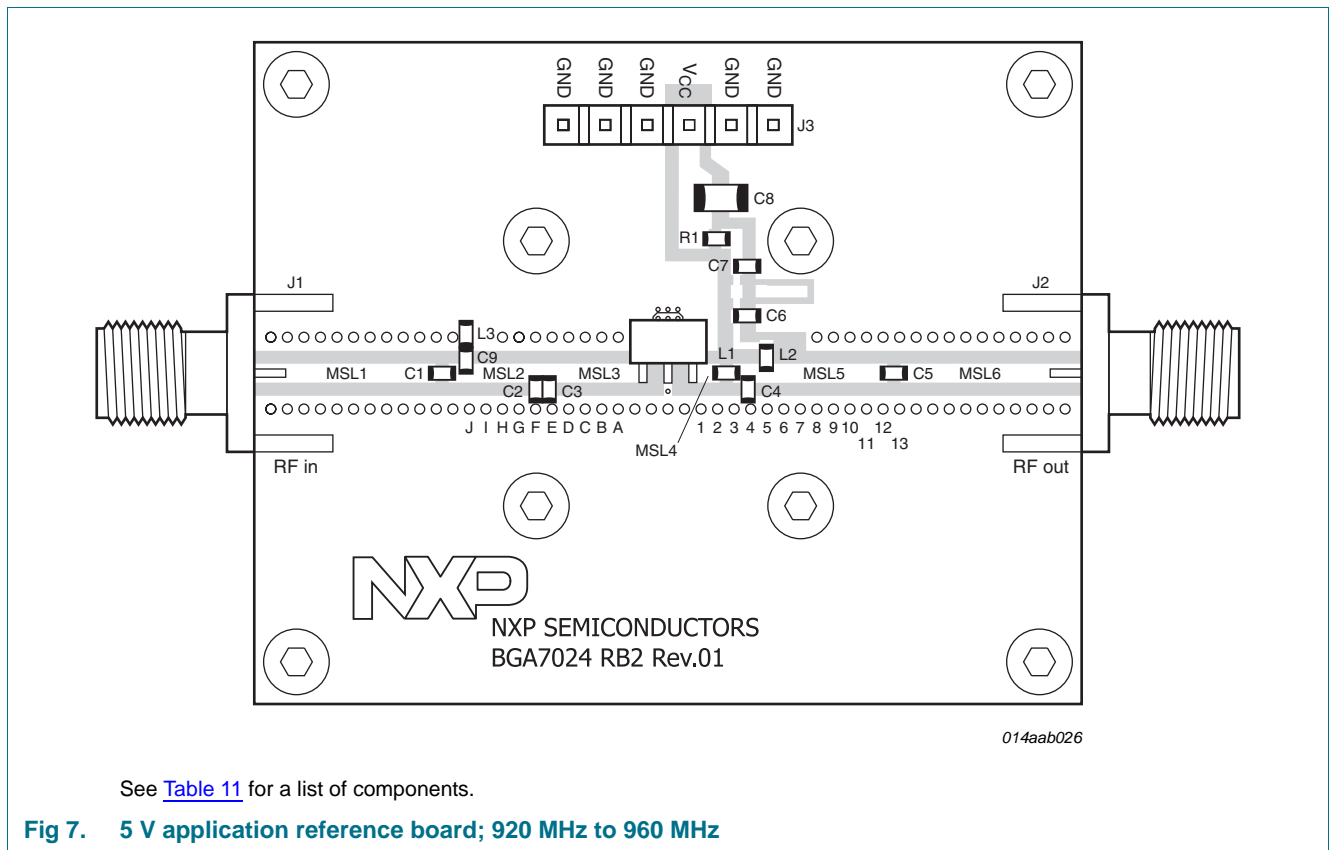
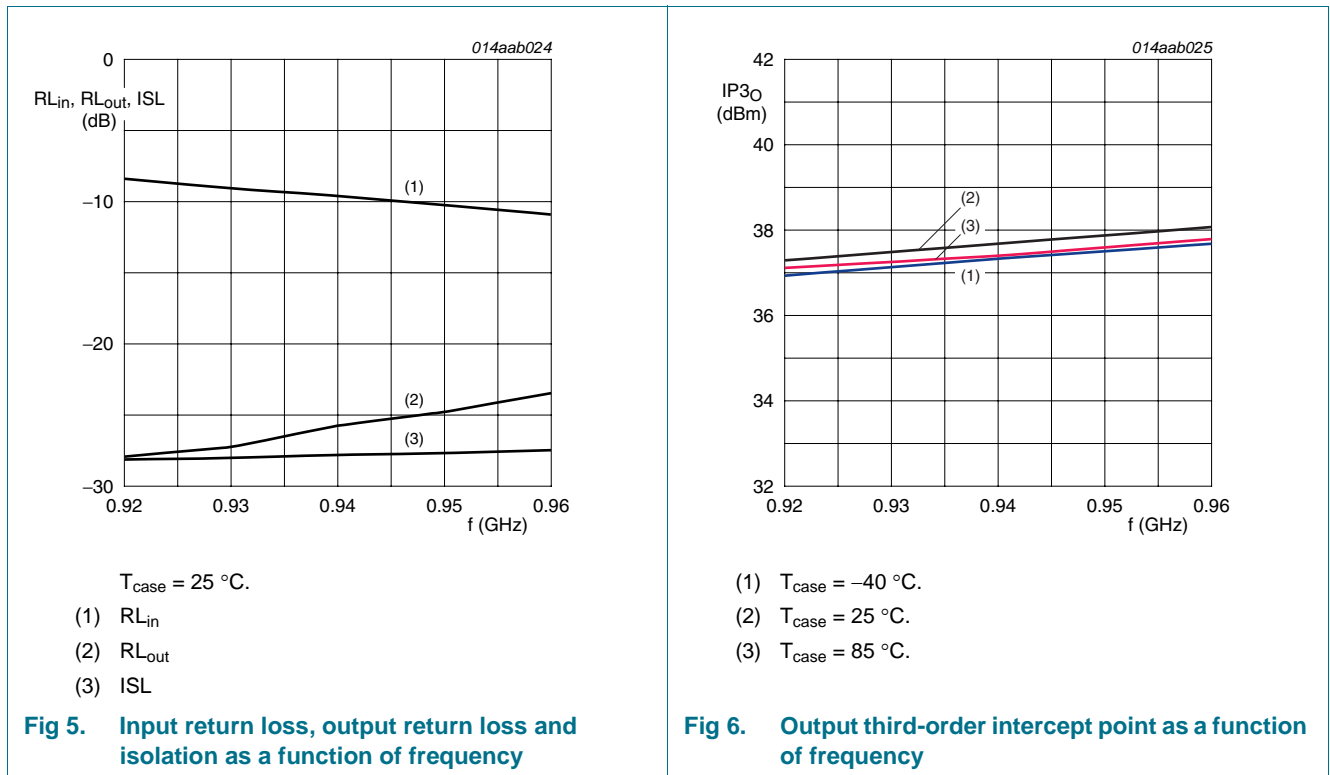

See [Table 11](#) for a list of components.

Table 11. 5 V application list of components; 920 MHz to 960 MHz

See [Figure 2](#) and [Figure 7](#) for component layout. PCB: Rogers RO4003C stack; height = 0.508 mm; copper plating thickness = 35 μm .

Component	Description	Value	Function	Remarks
C1, C5	capacitor	68 pF	DC blocking	Murata GRM1885C1H680JA01D
C2	capacitor	3.9 pF	input match	Murata GRM1885C1H3R9CZ01D
C3	capacitor	3.9 pF	input match	Murata GRM1885C1H3R9CZ01D
C4	capacitor	3.9 pF	output match	Murata GRM1885C1H3R9CZ01D
C6	capacitor	68 pF	RF decoupling	Murata GRM1885C1H680JA01D
C7	capacitor	100 nF	DC decoupling	AVX 0603YC104KAT2A
C8	capacitor	10 μF	DC decoupling	AVX 1206ZG106ZAT2A
C9	capacitor	68 nF	IMD suppression	Murata GRM1888R71H683KA93D
J1, J2	RF connector	SMA	-	Emerson Network Power 142-0701-841
J3	DC connector	6-pins	-	MOLEX
L1	inductor	4.7 nH	output match	Tyco Electronics 36501J4N7JTDG
L2	inductor	22 nH	DC feed	Tyco Electronics 36501J022JTDG
L3	inductor	33 nH	IMD suppression	Tyco Electronics 36501J033JTDG
MSL1 ^[1]	micro stripline	1.14 mm \times 0.8 mm \times 10.95 mm	input match	-
MSL2 ^[1]	micro stripline	1.14 mm \times 0.8 mm \times 5.65 mm	input match	-
MSL3 ^[1]	micro stripline	1.14 mm \times 0.8 mm \times 6.1 mm	input match	-
MSL4 ^[1]	micro stripline	1.14 mm \times 0.8 mm \times 1.6 mm	output match	-
MSL5 ^[1]	micro stripline	1.14 mm \times 0.8 mm \times 8.4 mm	output match	-
MSL6 ^[1]	micro stripline	1.14 mm \times 0.8 mm \times 10.95 mm	output match	-
R1	resistor	0 Ω	-	Multicomp MC 0.063W 0603 0R
PCB	-	RO4003C	-	-

[1] MSL1 to MSL6 dimensions specified as width \times spacing \times length.

12.2 1930 MHz to 1990 MHz

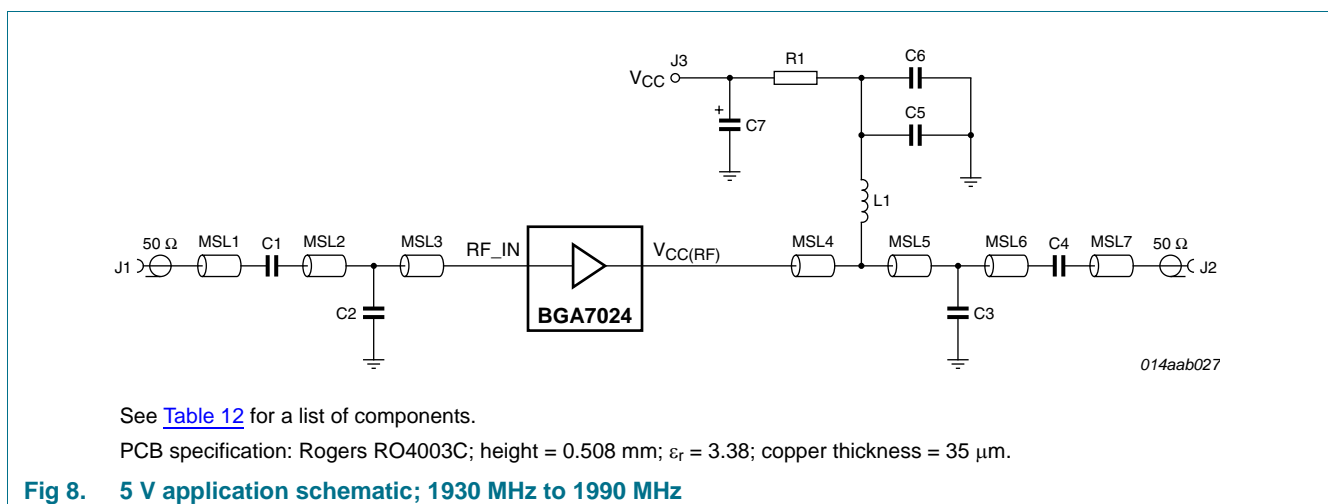

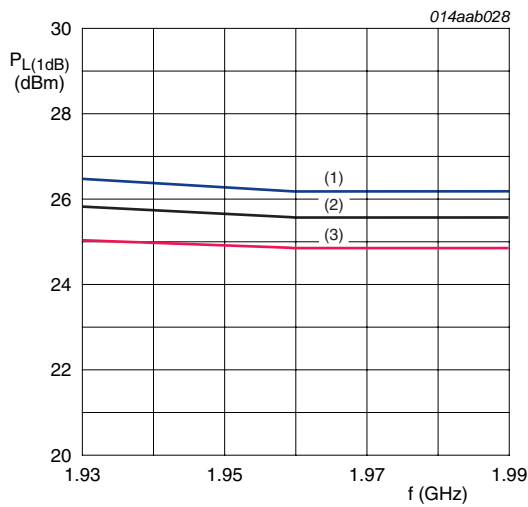

- (1) $T_{case} = -40\text{ }^{\circ}\text{C}.$
- (2) $T_{case} = 25\text{ }^{\circ}\text{C}.$
- (3) $T_{case} = 85\text{ }^{\circ}\text{C}.$

Fig 9. Output power at 1 dB gain compression as a function of frequency

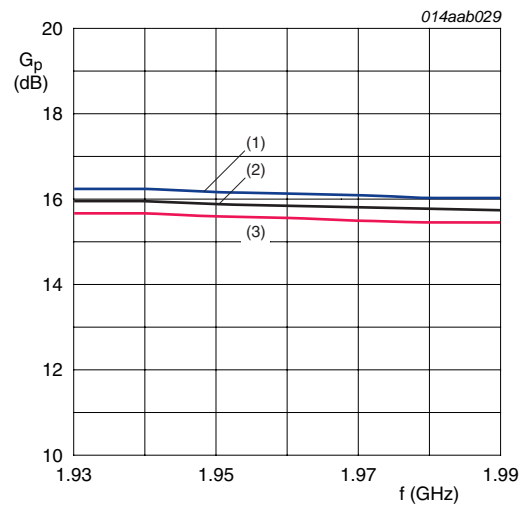

- (1) $T_{case} = -40\text{ }^{\circ}\text{C}.$
- (2) $T_{case} = 25\text{ }^{\circ}\text{C}.$
- (3) $T_{case} = 85\text{ }^{\circ}\text{C}.$

Fig 10. Power gain as a function of frequency

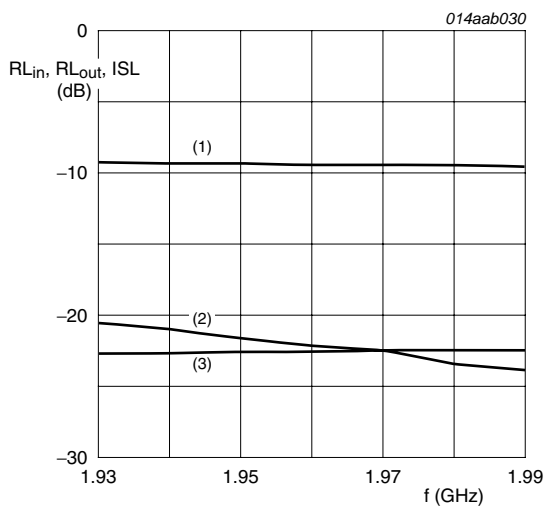

- $T_{case} = 25\text{ }^{\circ}\text{C}.$
- (1) RL_{in}
 - (2) RL_{out}
 - (3) ISL

Fig 11. Input return loss, output return loss and isolation as a function of frequency

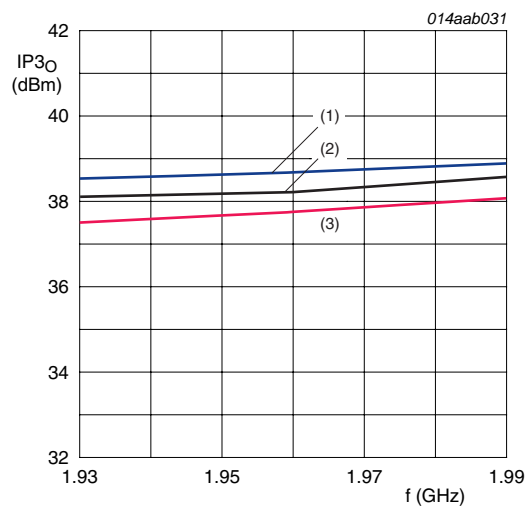

- (1) $T_{case} = -40\text{ }^{\circ}\text{C}.$
- (2) $T_{case} = 25\text{ }^{\circ}\text{C}.$
- (3) $T_{case} = 85\text{ }^{\circ}\text{C}.$

Fig 12. Output third-order intercept point as a function of frequency

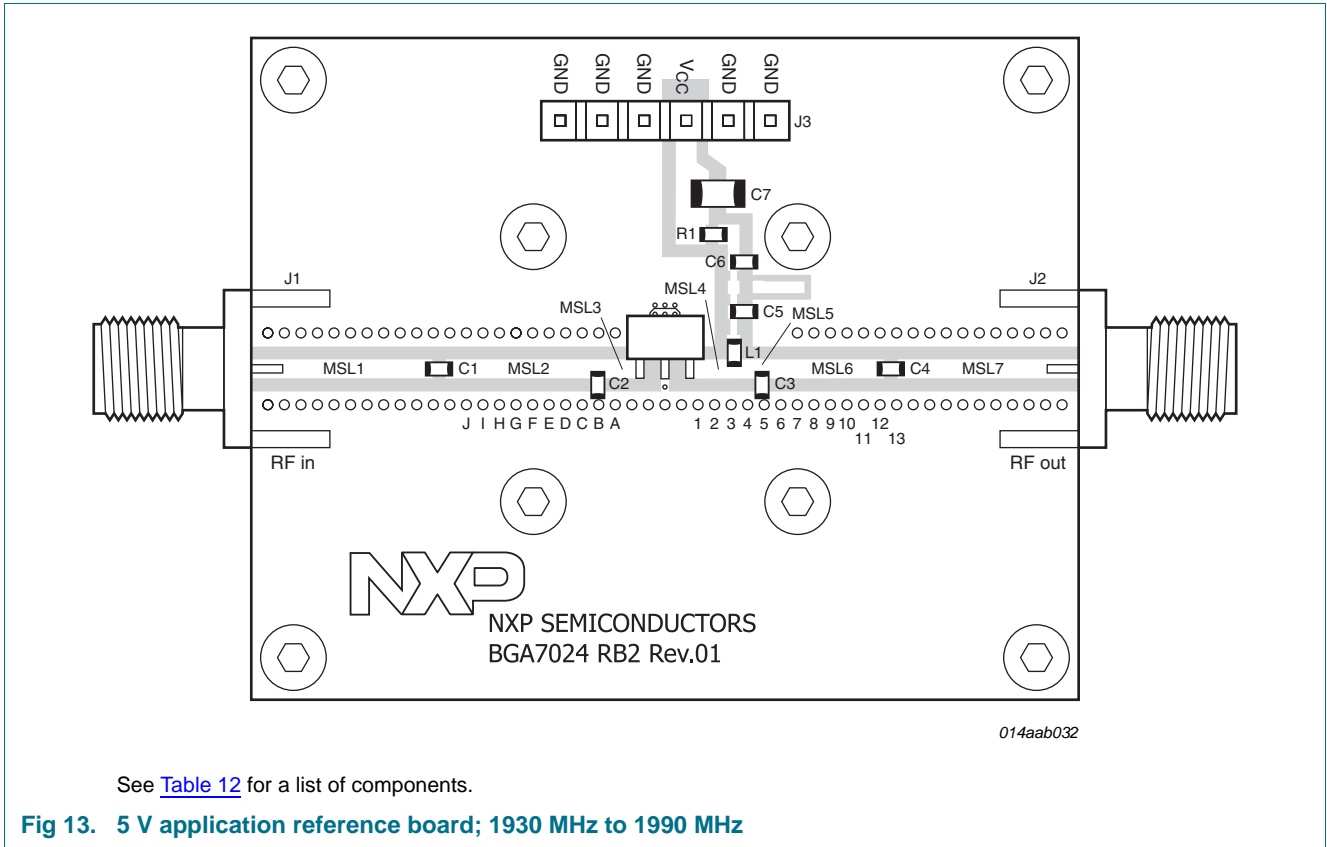

Table 12. 5 V application list of components; 1930 MHz to 1990 MHz

See [Figure 8](#) and [Figure 13](#) for component layout. PCB: Rogers RO4003C stack; height = 0.508 mm; copper plating thickness = 35 μm .

Component	Description	Value	Function	Remarks
C1, C4	capacitor	15 pF	DC blocking	Murata GRM1885C1H150JA01D
C2	capacitor	2.4 pF	input match	Murata GRM1885C1H2R4CZ01D
C3	capacitor	1.5 pF	output match	Murata GRM1885C1H1R5CZ01D
C5	capacitor	15 pF	RF decoupling	Murata GRM1885C1H150JA01D
C6	capacitor	100 nF	DC decoupling	AVX 0603YC104KAT2A
C7	capacitor	10 μF	DC decoupling	AVX 1206ZG106ZAT2A
J1, J2	RF connector	SMA	-	Emerson Network Power 142-0701-841
J3	DC connector	6-pins	-	MOLEX
L1	inductor	22 nH	DC feed	Tyco Electronics 36501J022JTDG
MSL1 ^[1]	micro stripline	1.14 mm \times 0.8 mm \times 10.95 mm	input match	-
MSL2 ^[1]	micro stripline	1.14 mm \times 0.8 mm \times 10.6 mm	input match	-
MSL3 ^[1]	micro stripline	1.14 mm \times 0.8 mm \times 1.0 mm	input match	-
MSL4 ^[1]	micro stripline	1.14 mm \times 0.8 mm \times 2.7 mm	output match	-
MSL5 ^[1]	micro stripline	1.14 mm \times 0.8 mm \times 3.2 mm	output match	-
MSL6 ^[1]	micro stripline	1.14 mm \times 0.8 mm \times 5.5 mm	output match	-
MSL7 ^[1]	micro stripline	1.14 mm \times 0.8 mm \times 10.95 mm	output match	-
R1	resistor	0 Ω	-	Multicomp MC 0.063W 0603 0R
PCB	-	RO4003C	-	-

[1] MSL1 to MSL7 dimensions specified as width \times spacing \times length.

12.3 2110 MHz to 2170 MHz

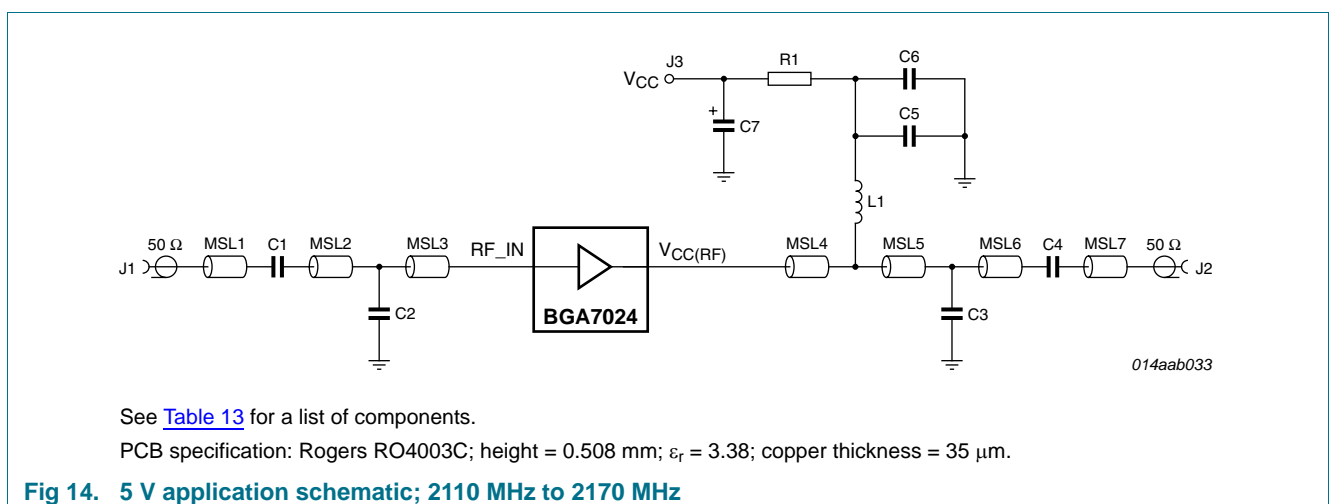

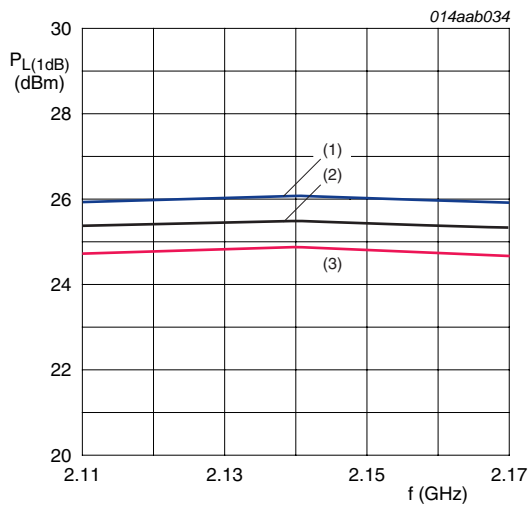

- (1) $T_{case} = -40\text{ }^{\circ}\text{C}$.
- (2) $T_{case} = 25\text{ }^{\circ}\text{C}$.
- (3) $T_{case} = 85\text{ }^{\circ}\text{C}$.

Fig 15. Output power at 1 dB gain compression as a function of frequency

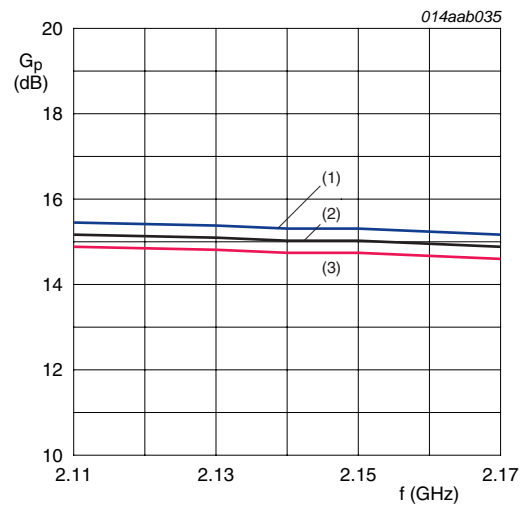

- (1) $T_{case} = -40\text{ }^{\circ}\text{C}$.
- (2) $T_{case} = 25\text{ }^{\circ}\text{C}$.
- (3) $T_{case} = 85\text{ }^{\circ}\text{C}$.

Fig 16. Power gain as a function of frequency

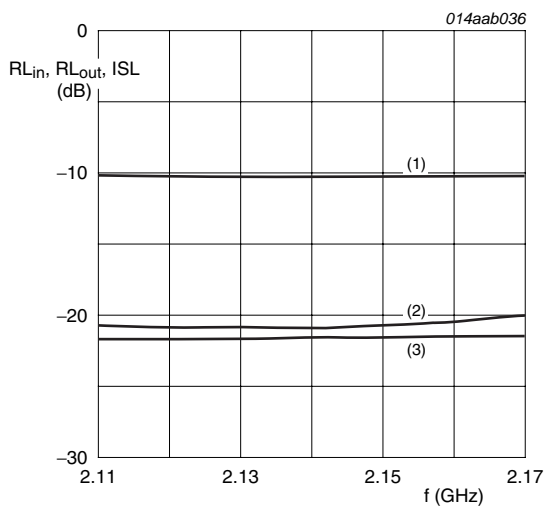

- $T_{case} = 25\text{ }^{\circ}\text{C}$.
- (1) RL_{in}
 - (2) RL_{out}
 - (3) ISL

Fig 17. Input return loss, output return loss and isolation as a function of frequency

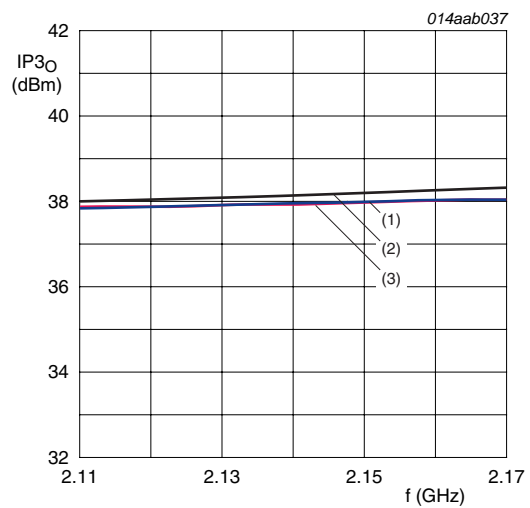

- (1) $T_{case} = -40\text{ }^{\circ}\text{C}$.
- (2) $T_{case} = 25\text{ }^{\circ}\text{C}$.
- (3) $T_{case} = 85\text{ }^{\circ}\text{C}$.

Fig 18. Output third-order intercept point as a function of frequency

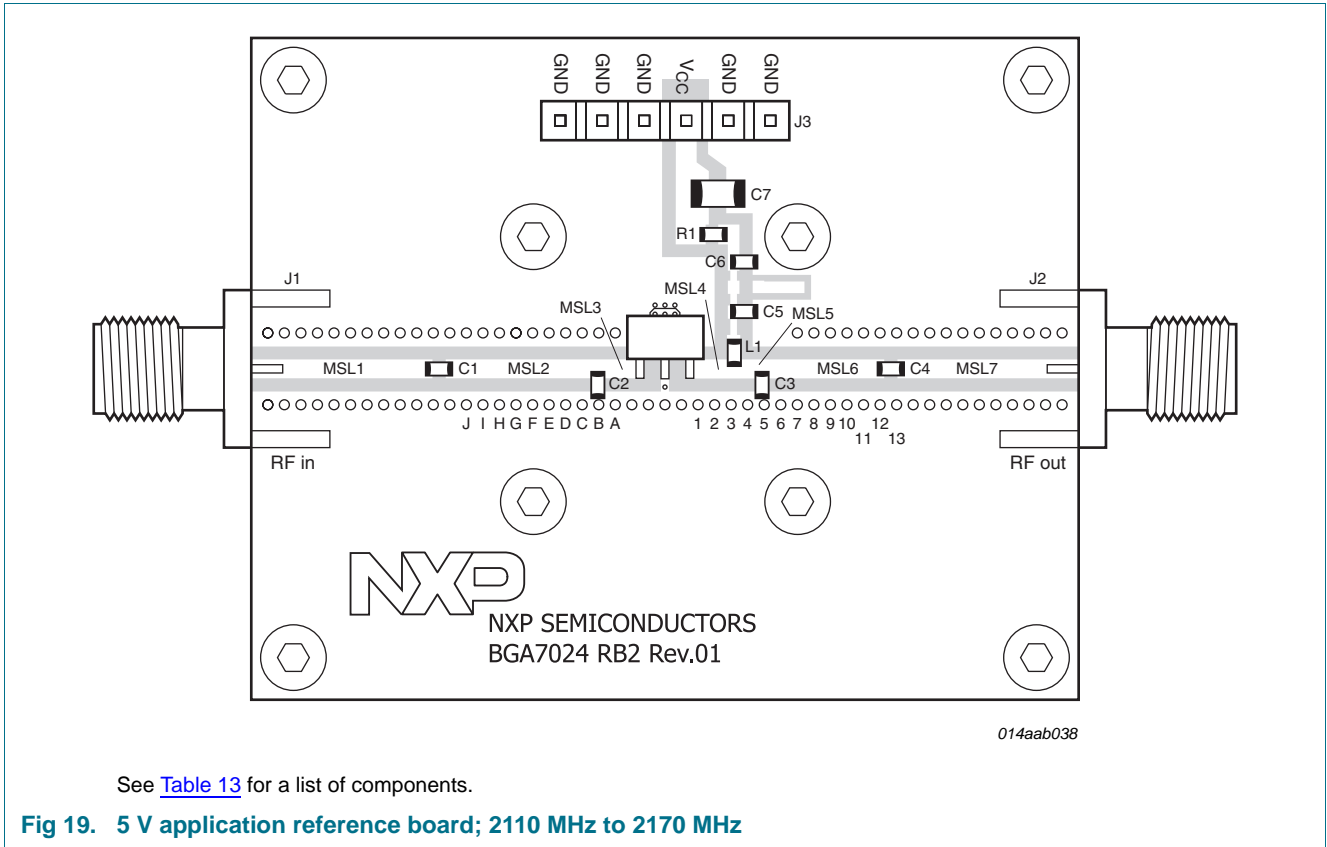

See [Table 13](#) for a list of components.

Fig 19. 5 V application reference board; 2110 MHz to 2170 MHz

Table 13. 5 V application list of components; 2110 MHz to 2170 MHz

See [Figure 14](#) and [Figure 19](#) for component layout. PCB: Rogers RO4003C stack; height = 0.508 mm; copper plating thickness = 35 μm .

Component	Description	Value	Function	Remarks
C1, C4	capacitor	15 pF	DC blocking	Murata GRM1885C1H150JA01D
C2	capacitor	2.2 pF	input match	Murata GRM1885C1H2R2CZ01D
C3	capacitor	1.5 pF	output match	Murata GRM1885C1H1R5CZ01D
C5	capacitor	15 pF	RF decoupling	Murata GRM1885C1H150JA01D
C6	capacitor	100 nF	DC decoupling	AVX 0603YC104KAT2A
C7	capacitor	10 μF	DC decoupling	AVX 1206ZG106ZAT2A
J1, J2	RF connector	SMA	-	Emerson Network Power 142-0701-841
J3	DC connector	6-pins	-	MOLEX
L1	inductor	22 nH	DC feed	Tyco Electronics 36501J022JTDG
MSL1 ^[1]	micro stripline	1.14 mm \times 0.8 mm \times 10.95 mm	input match	-
MSL2 ^[1]	micro stripline	1.14 mm \times 0.8 mm \times 10.6 mm	input match	-
MSL3 ^[1]	micro stripline	1.14 mm \times 0.8 mm \times 1.0 mm	input match	-
MSL4 ^[1]	micro stripline	1.14 mm \times 0.8 mm \times 2.7 mm	output match	-
MSL5 ^[1]	micro stripline	1.14 mm \times 0.8 mm \times 3.2 mm	output match	-
MSL6 ^[1]	micro stripline	1.14 mm \times 0.8 mm \times 5.5 mm	output match	-
MSL7 ^[1]	micro stripline	1.14 mm \times 0.8 mm \times 10.95 mm	output match	-
R1	resistor	0 Ω	-	Multicomp MC 0.063W 0603 0R
PCB	-	RO4003C	-	-

[1] MSL1 to MSL7 dimensions specified as width \times spacing \times length.

12.4 2405 MHz to 2485 MHz

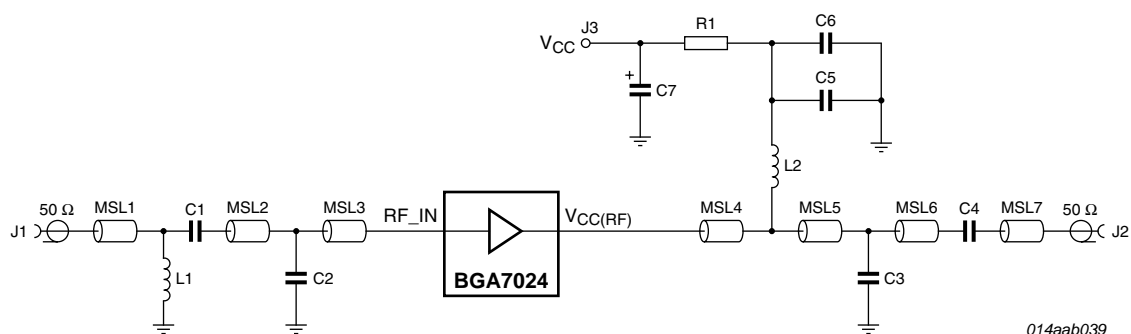

See [Table 14](#) for a list of components.

PCB specification: Rogers RO4003C; height = 0.508 mm; $\epsilon_r = 3.38$; copper thickness = 35 μm .

014aab039

Fig 20. 5 V application schematic; 2405 MHz to 2485 MHz

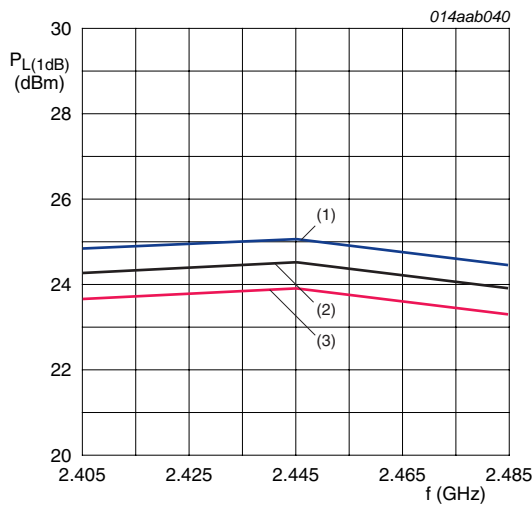

- (1) T_{case} = -40 °C.
- (2) T_{case} = 25 °C.
- (3) T_{case} = 85 °C.

Fig 21. Output power at 1 dB gain compression as a function of frequency

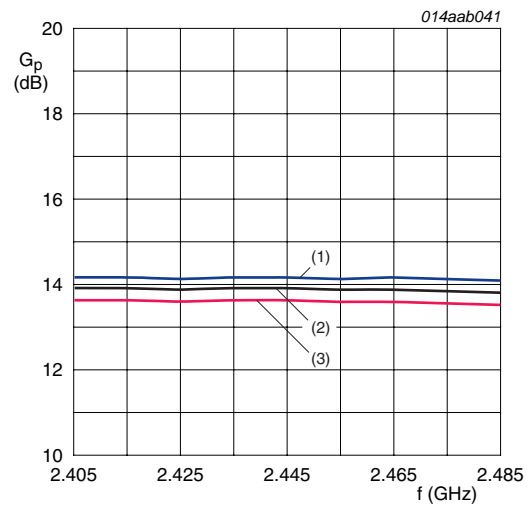

- (1) T_{case} = -40 °C.
- (2) T_{case} = 25 °C.
- (3) T_{case} = 85 °C.

Fig 22. Power gain as a function of frequency

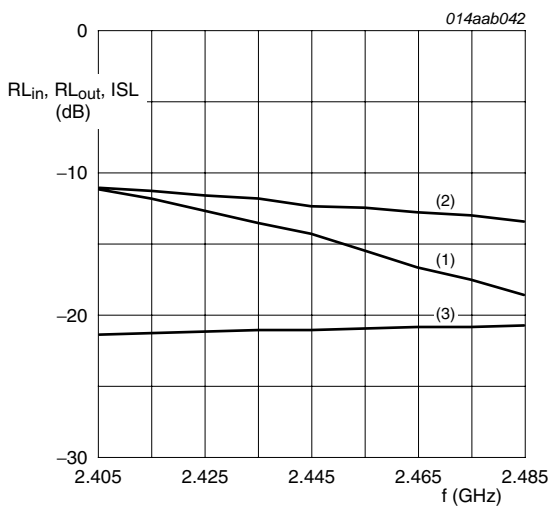

- T_{case} = 25 °C.
- (1) RL_{in}
 - (2) RL_{out}
 - (3) ISL

Fig 23. Input return loss, output return loss and isolation as a function of frequency

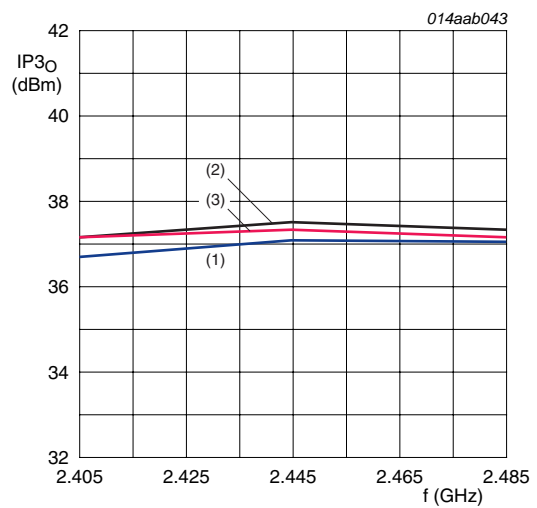

- (1) T_{case} = -40 °C.
- (2) T_{case} = 25 °C.
- (3) T_{case} = 85 °C.

Fig 24. Output third-order intercept point as a function of frequency

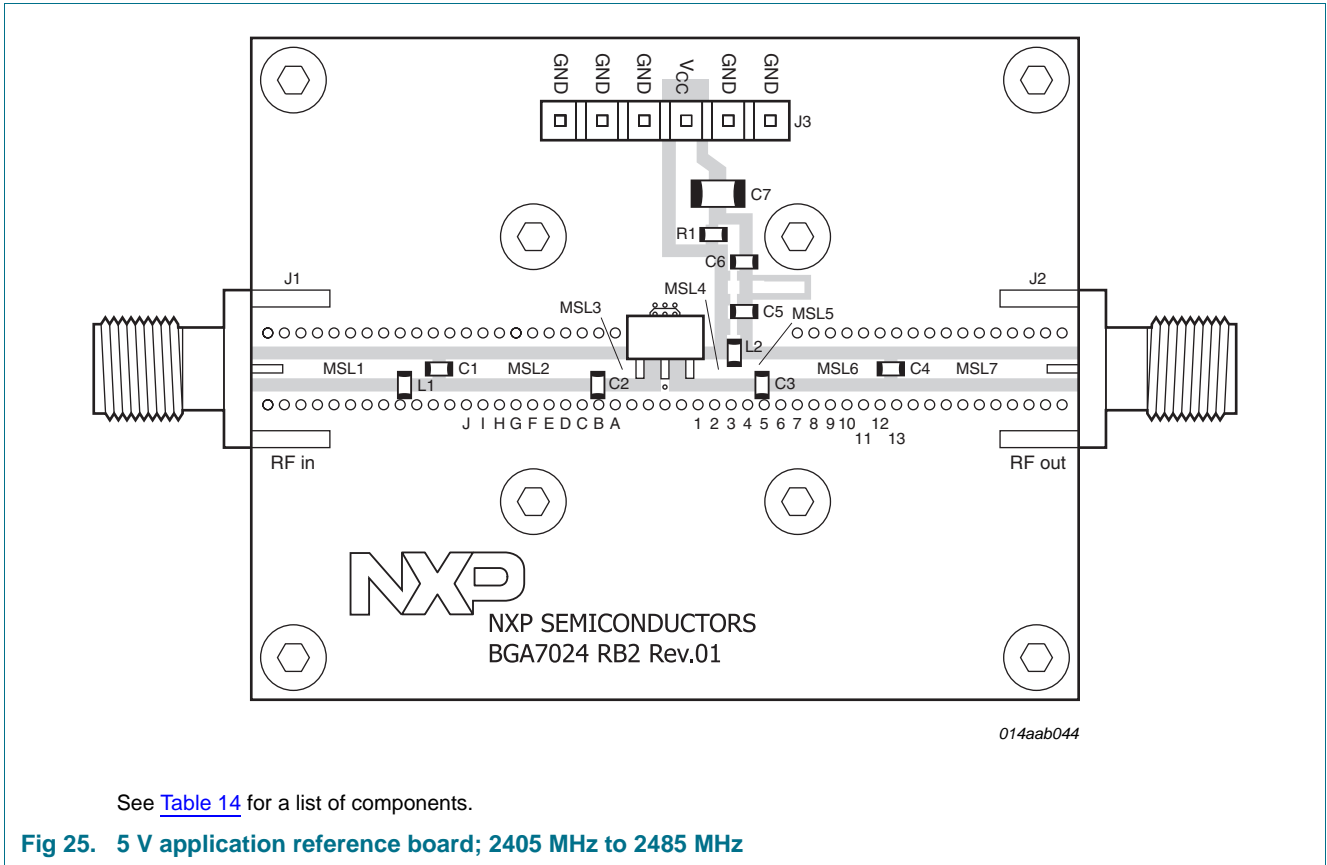

Table 14. 5 V application list of components; 2405 MHz to 2485 MHz

See [Figure 20](#) and [Figure 25](#) for component layout. PCB: Rogers RO4003C stack; height = 0.508 mm; copper plating thickness = 35 μm .

Component	Description	Value	Function	Remarks
C1, C4	capacitor	15 pF	DC blocking	Murata GRM1885C1H150JA01D
C2	capacitor	1.5 pF	input match	Murata GRM1885C1H1R5CZ01D
C3	capacitor	1.8 pF	output match	Murata GRM1885C1H1R8CZ01D
C5	capacitor	15 pF	RF decoupling	Murata GRM1885C1H150JA01D
C6	capacitor	100 nF	DC decoupling	AVX 0603YC104KAT2A
C7	capacitor	10 μF	DC decoupling	AVX 1206ZG106ZAT2A
J1, J2	RF connector	SMA	-	Emerson Network Power 142-0701-841
J3	DC connector	6-pins	-	MOLEX
L1	inductor	3.3 nH	input match	Tyco Electronics 36501J3N3JTDG
L2	inductor	22 nH	DC feed	Tyco Electronics 36501J022JTDG
MSL1 ^[1]	micro stripline	1.14 mm \times 0.8 mm \times 10.95 mm	input match	-
MSL2 ^[1]	micro stripline	1.14 mm \times 0.8 mm \times 9.8 mm	input match	-
MSL3 ^[1]	micro stripline	1.14 mm \times 0.8 mm \times 1.9 mm	output match	-
MSL4 ^[1]	micro stripline	1.14 mm \times 0.8 mm \times 2.5 mm	output match	-
MSL5 ^[1]	micro stripline	1.14 mm \times 0.8 mm \times 1.6 mm	output match	-
MSL6 ^[1]	micro stripline	1.14 mm \times 0.8 mm \times 7.3 mm	output match	-
MSL7 ^[1]	micro stripline	1.14 mm \times 0.8 mm \times 10.95 mm	output match	-
R1	resistor	0 Ω	-	Multicomp MC 0.063W 0603 0R
PCB	-	RO4003C	-	-

[1] MSL1 to MSL7 dimensions specified as width \times spacing \times length.

12.5 PCB stack

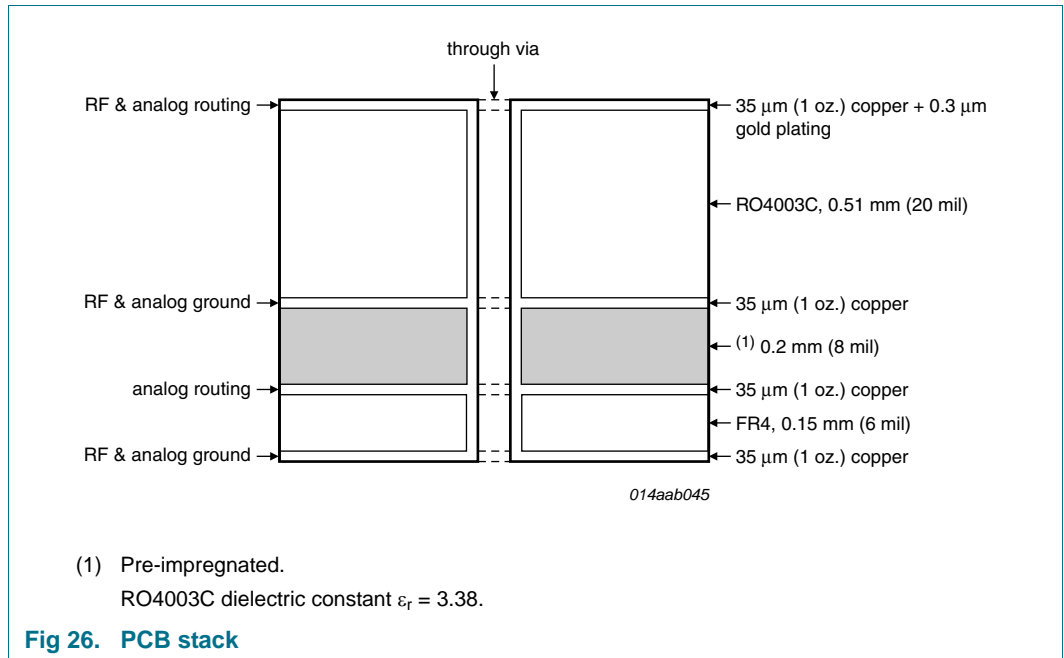

13. Package outline

Plastic surface-mounted package; exposed die pad for good heat transfer; 3 leads

SOT89

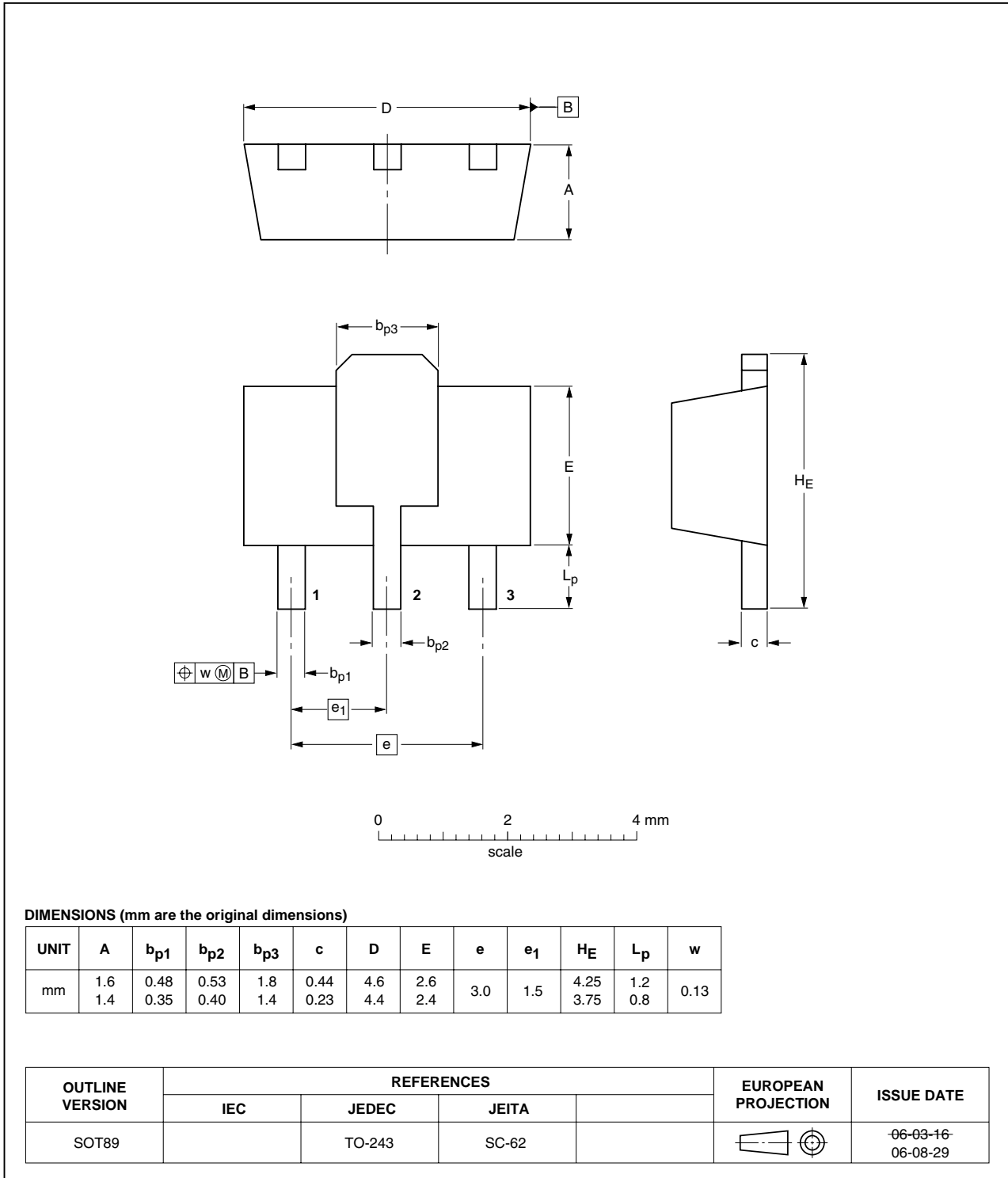

Fig 27. Package outline SOT89

14. Abbreviations

Table 15. Abbreviations

Acronym	Description
CPE	Customer-Premises Equipment
DC	Direct Current
ESD	ElectroStatic Discharge
HTOL	High Temperature Operating Life
ISM	Industrial, Scientific and Medical
MMIC	Monolithic Microwave Integrated Circuit
MoCA	Multimedia over Coax Alliance
PCB	Printed-Circuit Board
RFID	Radio Frequency IDentification
TX	Transmit
WLAN	Wireless Local Area Network

15. Revision history

Table 16. Revision history

Document ID	Release date	Data sheet status	Change notice	Supersedes
BGA7024_1	20100528	Product data sheet	-	-

16. Legal information

16.1 Data sheet status

Document status ^{[1][2]}	Product status ^[3]	Definition
Objective [short] data sheet	Development	This document contains data from the objective specification for product development.
Preliminary [short] data sheet	Qualification	This document contains data from the preliminary specification.
Product [short] data sheet	Production	This document contains the product specification.

[1] Please consult the most recently issued document before initiating or completing a design.

[2] The term 'short data sheet' is explained in section "Definitions".

[3] The product status of device(s) described in this document may have changed since this document was published and may differ in case of multiple devices. The latest product status information is available on the Internet at URL <http://www.nxp.com>.

16.2 Definitions

Draft — The document is a draft version only. The content is still under internal review and subject to formal approval, which may result in modifications or additions. NXP Semiconductors does not give any representations or warranties as to the accuracy or completeness of information included herein and shall have no liability for the consequences of use of such information.

Short data sheet — A short data sheet is an extract from a full data sheet with the same product type number(s) and title. A short data sheet is intended for quick reference only and should not be relied upon to contain detailed and full information. For detailed and full information see the relevant full data sheet, which is available on request via the local NXP Semiconductors sales office. In case of any inconsistency or conflict with the short data sheet, the full data sheet shall prevail.

Product specification — The information and data provided in a Product data sheet shall define the specification of the product as agreed between NXP Semiconductors and its customer, unless NXP Semiconductors and customer have explicitly agreed otherwise in writing. In no event however, shall an agreement be valid in which the NXP Semiconductors product is deemed to offer functions and qualities beyond those described in the Product data sheet.

16.3 Disclaimers

Limited warranty and liability — Information in this document is believed to be accurate and reliable. However, NXP Semiconductors does not give any representations or warranties, expressed or implied, as to the accuracy or completeness of such information and shall have no liability for the consequences of use of such information.

In no event shall NXP Semiconductors be liable for any indirect, incidental, punitive, special or consequential damages (including - without limitation - lost profits, lost savings, business interruption, costs related to the removal or replacement of any products or rework charges) whether or not such damages are based on tort (including negligence), warranty, breach of contract or any other legal theory.

Notwithstanding any damages that customer might incur for any reason whatsoever, NXP Semiconductors' aggregate and cumulative liability towards customer for the products described herein shall be limited in accordance with the *Terms and conditions of commercial sale* of NXP Semiconductors.

Right to make changes — NXP Semiconductors reserves the right to make changes to information published in this document, including without limitation specifications and product descriptions, at any time and without notice. This document supersedes and replaces all information supplied prior to the publication hereof.

Suitability for use — NXP Semiconductors products are not designed, authorized or warranted to be suitable for use in life support, life-critical or safety-critical systems or equipment, nor in applications where failure or

malfunction of an NXP Semiconductors product can reasonably be expected to result in personal injury, death or severe property or environmental damage. NXP Semiconductors accepts no liability for inclusion and/or use of NXP Semiconductors products in such equipment or applications and therefore such inclusion and/or use is at the customer's own risk.

Applications — Applications that are described herein for any of these products are for illustrative purposes only. NXP Semiconductors makes no representation or warranty that such applications will be suitable for the specified use without further testing or modification.

Customers are responsible for the design and operation of their applications and products using NXP Semiconductors products, and NXP Semiconductors accepts no liability for any assistance with applications or customer product design. It is customer's sole responsibility to determine whether the NXP Semiconductors product is suitable and fit for the customer's applications and products planned, as well as for the planned application and use of customer's third party customer(s). Customers should provide appropriate design and operating safeguards to minimize the risks associated with their applications and products.

NXP Semiconductors does not accept any liability related to any default, damage, costs or problem which is based on any weakness or default in the customer's applications or products, or the application or use by customer's third party customer(s). Customer is responsible for doing all necessary testing for the customer's applications and products using NXP Semiconductors products in order to avoid a default of the applications and the products or of the application or use by customer's third party customer(s). NXP does not accept any liability in this respect.

Limiting values — Stress above one or more limiting values (as defined in the Absolute Maximum Ratings System of IEC 60134) will cause permanent damage to the device. Limiting values are stress ratings only and (proper) operation of the device at these or any other conditions above those given in the Recommended operating conditions section (if present) or the Characteristics sections of this document is not warranted. Constant or repeated exposure to limiting values will permanently and irreversibly affect the quality and reliability of the device.

Terms and conditions of commercial sale — NXP Semiconductors products are sold subject to the general terms and conditions of commercial sale, as published at <http://www.nxp.com/profile/terms>, unless otherwise agreed in a valid written individual agreement. In case an individual agreement is concluded only the terms and conditions of the respective agreement shall apply. NXP Semiconductors hereby expressly objects to applying the customer's general terms and conditions with regard to the purchase of NXP Semiconductors products by customer.

No offer to sell or license — Nothing in this document may be interpreted or construed as an offer to sell products that is open for acceptance or the grant, conveyance or implication of any license under any copyrights, patents or other industrial or intellectual property rights.

Export control — This document as well as the item(s) described herein may be subject to export control regulations. Export might require a prior authorization from national authorities.

Quick reference data — The Quick reference data is an extract of the product data given in the Limiting values and Characteristics sections of this document, and as such is not complete, exhaustive or legally binding.

Non-automotive qualified products — Unless this data sheet expressly states that this specific NXP Semiconductors product is automotive qualified, the product is not suitable for automotive use. It is neither qualified nor tested in accordance with automotive testing or application requirements. NXP Semiconductors accepts no liability for inclusion and/or use of non-automotive qualified products in automotive equipment or applications.

In the event that customer uses the product for design-in and use in automotive applications to automotive specifications and standards, customer (a) shall use the product without NXP Semiconductors' warranty of the

product for such automotive applications, use and specifications, and (b) whenever customer uses the product for automotive applications beyond NXP Semiconductors' specifications such use shall be solely at customer's own risk, and (c) customer fully indemnifies NXP Semiconductors for any liability, damages or failed product claims resulting from customer design and use of the product for automotive applications beyond NXP Semiconductors' standard warranty and NXP Semiconductors' product specifications.

16.4 Trademarks

Notice: All referenced brands, product names, service names and trademarks are the property of their respective owners.

17. Contact information

For more information, please visit: <http://www.nxp.com>

For sales office addresses, please send an email to: salesaddresses@nxp.com

18. Contents

1	Product profile	1
1.1	General description	1
1.2	Features and benefits	1
1.3	Applications	1
1.4	Quick reference data	1
2	Pinning information	2
3	Ordering information	2
4	Functional diagram	2
5	Limiting values	3
6	Thermal characteristics	3
7	Static characteristics	3
8	Dynamic characteristics	3
9	Scattering parameters	4
10	Reliability information	5
11	Moisture sensitivity	5
12	Application information	6
12.1	920 MHz to 960 MHz	6
12.2	1930 MHz to 1990 MHz	8
12.3	2110 MHz to 2170 MHz	11
12.4	2405 MHz to 2485 MHz	14
12.5	PCB stack	17
13	Package outline	18
14	Abbreviations	19
15	Revision history	19
16	Legal information	20
16.1	Data sheet status	20
16.2	Definitions	20
16.3	Disclaimers	20
16.4	Trademarks	21
17	Contact information	21
18	Contents	22

Please be aware that important notices concerning this document and the product(s) described herein, have been included in section 'Legal information'.

© NXP B.V. 2010.

All rights reserved.

For more information, please visit: <http://www.nxp.com>

For sales office addresses, please send an email to: salesaddresses@nxp.com

Date of release: 28 May 2010

Document identifier: BGA7024_1