

BGS13S2N9

Wideband RF SP3T Switch

Data Sheet

Revision 1.0 - 2016-02-02

Final

Edition 2016-02-02

**Published by Infineon Technologies AG
81726 Munich, Germany**

**©2016 Infineon Technologies AG
All Rights Reserved.**

LEGAL DISCLAIMER

The information given in this document shall in no event be regarded as a guarantee of conditions or characteristics. With respect to any examples or hints given herein, any typical values stated herein and/or any information regarding the application of the device, Infineon Technologies hereby disclaims any and all warranties and liabilities of any kind, including without limitation, warranties of non-infringement of intellectual property rights of any third party.

Information

For further information on technology, delivery terms and conditions and prices, please contact the nearest Infineon Technologies Office (www.infineon.com).

Warnings

Due to technical requirements, components may contain dangerous substances. For information on the types in question, please contact the nearest Infineon Technologies Office. Infineon Technologies components may be used in life-support devices or systems only with the express written approval of Infineon Technologies, if a failure of such components can reasonably be expected to cause the failure of that life-support device or system or to affect the safety or effectiveness of that device or system. Life support devices or systems are intended to be implanted in the human body or to support and/or maintain and sustain and/or protect human life. If they fail, it is reasonable to assume that the health of the user or other persons may be endangered.

Revision History

Document No.: BGS13S2N9_Final_v1.0.pdf

Revision History: Final Rev. v1.0

Previous Version: Target, Revision v1.4 - 2015-12-23

Page	Subjects (major changes since last revision)

Trademarks of Infineon Technologies AG

μ HVICTM, μ IPMTM, μ PFCTM, AU-ConvertIRTM, AURIXTM, C166TM, CanPAKTM, CIPOSTM, CIPURSETM, CoolDPTM, CoolGaNTM, COOLiRTM, CoolMOSTM, CoolSETTM, CoolSiCTM, DAVETM, DI-POLTM, DirectFETTM, DrBladeTM, EasyPIMTM, EconoBRIDGETM, EconoDUALTM, EconoPACKTM, EconoPIMTM, EiceDRIVERTM, eupecTM, FCOSTM, GaNpowIRTM, HEXFETTM, HITFETTM, HybridPACKTM, iMOTIONTM, IRAMTM, ISOFACETM, IsoPACKTM, LEDrivIRTM, LITIXTM, MIPAQTM, ModSTACKTM, my-dTM, NovalithICTM, OPTIGATM, OptiMOSTM, ORIGATM, PowIRaudioTM, PowIRStageTM, PrimePACKTM, PrimeSTACKTM, PROFETTM, PRO-SILTM, RASICTM, REAL3TM, SmartLEWISTM, SOLID FLASHTM, SPOCTM, StrongIRFETTM, SupIRBuckTM, TEMPFETTM, TRENCHSTOPTM, TriCoreTM, UHVICTM, XHPTM, XMCTM.

Other Trademarks

All referenced product or service names and trademarks are the property of their respective owners.

Trademarks updated November 2015

Contents

1 Features	5
2 Product Description	5
3 Maximum Ratings	6
4 Operation Ranges	7
5 RF Characteristics	8
6 GPIO Specification	10
7 Pin Definition and Package Outline	10

List of Figures

1 BGS13S2N9 Block Diagram	6
2 Pin out (top view)	10
3 Package Outline (bottom and side view)	11
4 Land pattern and stencil mask	11
5 Marking Pattern	12
6 Tape and Reel (Reel ϕ 180 mm: 15.000 Pieces/Reel)	13

List of Tables

1 Ordering Information	5
2 Maximum Ratings, Table I	6
3 Maximum Ratings, Table II	7
4 Operation Ranges	7
5 RF Input Power	7
6 RF Characteristics	8
7 RF Characteristics	9
8 GPIO Truth Table	10
9 Pin Configuration	10
10 Mechanical Data	11
11 Year Date Code	12
12 Week Date Code	12

BGS13S2N9 Wideband RF SP3T Switch

1 Features

- 3 high-linearity TRx paths with power handling capability of up to 30 dBm
- Low insertion loss
- Low harmonic generation
- High port-to-port-isolation
- Suitable for Edge / CDMA2000 / LTE / WCDMA applications
- 0.1 to 3.0 GHz coverage
- No decoupling capacitors required if no DC applied on RF lines
- On-chip control logic including ESD protection
- General Purpose Input-Output (GPIO) Interface
- Small form factor 1.1 mm x 1.1 mm x 0.375 mm
- No power supply blocking required
- High EMI robustness
- RoHS and WEEE compliant package

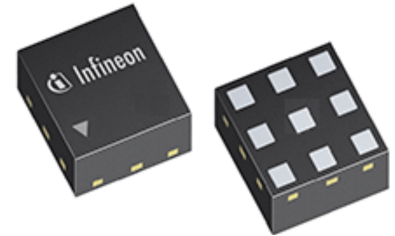

2 Product Description

The BGS13S2N9 RF MOS switch is specifically designed for cell phone and mobile applications. Any of the 3 ports can be used as termination of the diversity antenna handling up to 30 dBm.

This SP3T offers low insertion loss and high robustness against interferer signals at the antenna port and low harmonic generation in termination mode. The on-chip controller integrates CMOS logic and level shifters, driven by control inputs from 1.35 V to VDD . The BGS13S2N9 RF Switch is manufactured in Infineon's patented MOS technology, offering the performance of GaAs with the economy and integration of conventional CMOS including the inherent higher ESD robustness. The device has a very small size of only 1.1 x 1.1 mm² and a maximum height of 0.375 mm.

No decoupling capacitors are required in typical applications as long as no DC is applied to any RF port.

Table 1: Ordering Information

Type	Package	Marking
BGS13S2N9	TSNP-9-3	R

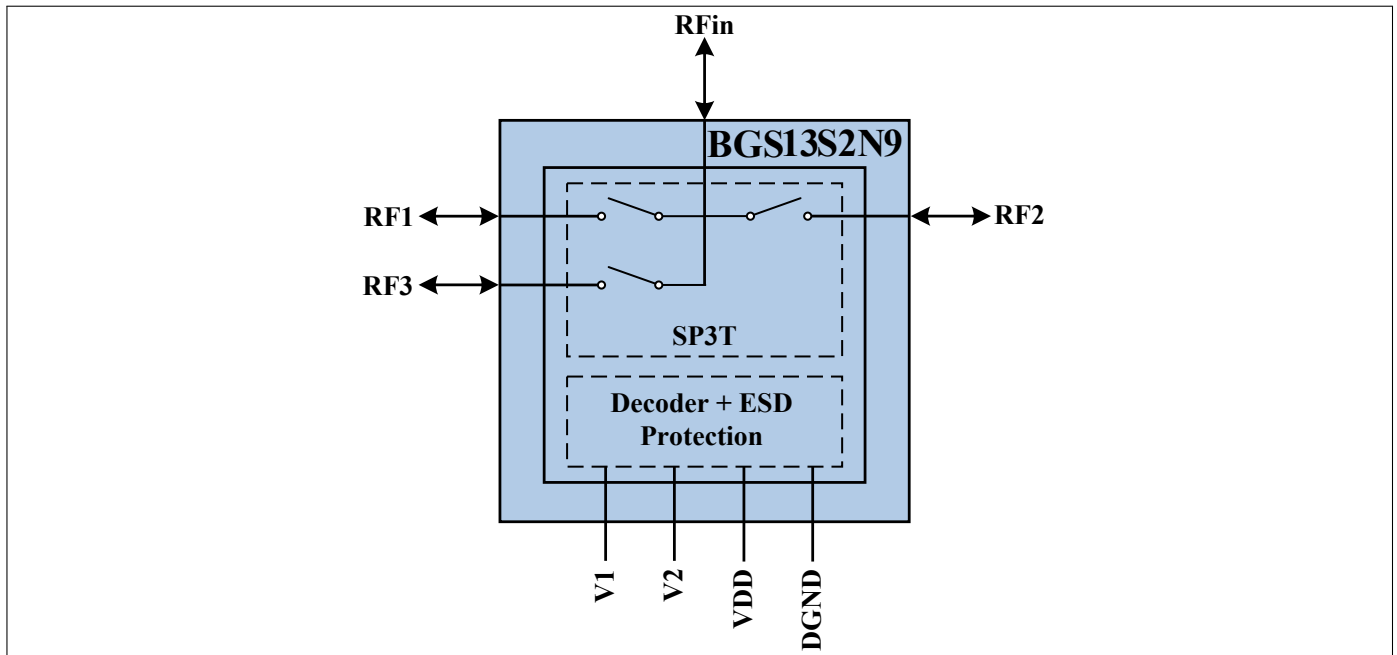

Figure 1: BGS13S2N9 Block Diagram

3 Maximum Ratings

Stresses above the maximum values listed here may cause permanent damage to the device. Exposure to absolute maximum rating conditions for extended periods may affect device reliability. Maximum ratings are absolute ratings; exceeding only one of these values may cause irreversible damage to the integrated circuit.

Table 2: Maximum Ratings, Table I at $T_A = 25\text{ }^\circ\text{C}$, unless otherwise specified

Parameter	Symbol	Values			Unit	Note / Test Condition
		Min.	Typ.	Max.		
Frequency Range	f	0.1	–	3.0	GHz	1)
Supply voltage	V_{DD}	-0.5	–	3.6	V	–
Storage temperature range	T_{STG}	-55	–	150	$^\circ\text{C}$	–
Junction temperature	T_j	–	–	125	$^\circ\text{C}$	–
RF input power at all Rx ports	P_{RF_Rx}	–	–	32	dBm	CW
ESD capability, CDM ²⁾	V_{ESD_CDM}	-1000	–	+1000	V	All pins
ESD capability, HBM ³⁾	V_{ESD_HBM}	-500	–	+500	V	All pins excluding RFin
		-250	–	+250	V	RFin vs. other pins
ESD capability, system level ⁴⁾	V_{ESD_ANT}	-8000	–	+8000	V	ANT versus system GND, with 27 nH shunt inductor

1) There is also a DC connection between switched paths. The DC voltage at RF ports V_{RFDC} has to be 0V.

2) Field-Induced Charged-Device Model JESD22-C101. Simulates charging/discharging events that occur in production equipment and processes. Potential for CDM ESD events occurs whenever there is metal-to-metal contact in manufacturing.

3) Human Body Model ANSI/ESDA/JEDEC JS-001-2012 (R=1.5 k Ω , C=100 pF).

4) IEC 61000-4-2 (R=330 Ω , C=150 pF), contact discharge.

Table 3: Maximum Ratings, Table II at $T_A = 25\text{ °C}$, unless otherwise specified

Parameter	Symbol	Values			Unit	Note / Test Condition
		Min.	Typ.	Max.		
Maximum DC-voltage on RF-Ports and RF-Ground	V_{RFDC}	0	–	0	V	No DC voltages allowed on RF-Ports

4 Operation Ranges

Table 4: Operation Ranges

Parameter	Symbol	Values			Unit	Note / Test Condition
		Min.	Typ.	Max.		
Supply voltage	V_{DD}	1.8	–	3.3	V	–
Supply current ¹⁾	I_{DD}	–	80	200	μA	–
GPIO control voltage high	V_{Ctrl_H}	1.35	–	V_{DD}	V	–
GPIO control voltage low	V_{Ctrl_L}	-0.3	–	0.43	V	–
GPIO control input capacitance	C_{Ctrl}	–	–	2	pF	–
Ambient temperature	T_A	-40	25	85	$^{\circ}\text{C}$	–

¹⁾ $T_A = -40\text{ °C} - 85\text{ °C}$, $V_{DD} = 1.8 - 3.3\text{ V}$
Table 5: RF Input Power

Parameter	Symbol	Values			Unit	Note / Test Condition
		Min.	Typ.	Max.		
Rx ports (50 Ω)	P_{RF_Rx}	–	–	30	dBm	CW

5 RF Characteristics

Table 6: RF Characteristics at $T_A = -40\text{ }^\circ\text{C} - 85\text{ }^\circ\text{C}$, $P_{IN} = 0\text{ dBm}$, Supply Voltage $V_{DD} = 1.8\text{ V} - 3.3\text{ V}$, $Z_0 = 50\text{ Ohm}$, unless otherwise specified

Parameter	Symbol	Values			Unit	Note / Test Condition
		Min.	Typ.	Max.		
Insertion Loss						
All Rx Ports	IL	0.10	0.25	0.35	dB	824–915 MHz
		0.15	0.30	0.50	dB	1710–1910 MHz
		0.15	0.40	0.70	dB	2170–2500 MHz
		0.20	0.55	0.85	dB	2700MHz
Insertion Loss¹⁾						
All Rx Ports	IL	0.20	0.25	0.30	dB	824–915 MHz
		0.25	0.30	0.45	dB	1710–1910 MHz
		0.30	0.35	0.60	dB	2170–2500 MHz
		0.45	0.55	0.75	dB	2700MHz
Return Loss						
All Rx Ports	RL	21	30	54	dB	824–915 MHz
		17	22	29	dB	1710–1910 MHz
		16	20	26	dB	2170–2500 MHz
		12	16	20	dB	2700MHz
Isolation¹⁾						
RF _{in} to RF1/RF2/RF3 ²⁾	ISO _{In-RFx}	32	37	44	dB	824–915 MHz
		22	27	33	dB	1710–1910 MHz
		19	24	29	dB	2170–2500 MHz
		18	22	27	dB	2700MHz
RF1 to RF2 / RF2 to RF1 ³⁾ RF1 to RF3 / RF3 to RF1 ⁴⁾ RF2 to RF3 / RF3 to RF2 ⁵⁾	ISO _{port-port}	34	38	43	dB	824–915 MHz
		20	25	27	dB	1710–1910 MHz
		18	22	25	dB	2170–2500 MHz
		15	19	23	dB	2700MHz

¹⁾ $T_A = 25\text{ }^\circ\text{C}$, $V_{DD} = 3\text{ V}$

²⁾ Any RF Port ON

³⁾ RF1 or RF2 ON

⁴⁾ RF1 or RF3 ON

⁵⁾ RF2 or RF3 ON

Table 7: RF Characteristics at $T_A = -40\text{ }^{\circ}\text{C} - 85\text{ }^{\circ}\text{C}$, $P_{IN} = 0\text{ dBm}$, Supply Voltage $V_{DD} = 1.8\text{ V} - 3.3\text{ V}$, $Z_0 = 50\text{ }\Omega$, unless otherwise specified

Parameter	Symbol	Values			Unit	Note / Test Condition
		Min.	Typ.	Max.		
P0.1 dB Compression Point, Extrapolated						
All Rx Ports	$P_{0.1dB}$	34	–	–	dBm	
Harmonic Generation up to 12.75 GHz						
H2	P_{Harm}	–	-90	-80	dBc	27 dBm, 50 Ω , CW mode
H3	P_{Harm}	–	-90	-80	dBc	27 dBm, 50 Ω , CW mode
Intermodulation Distortion in Rx Band¹⁾ ($T_A = 25\text{ }^{\circ}\text{C}$)						
IMD2	IMD2	–	-110	-105	dBm	Tx = 10 dBm, Interferer = -15 dBm, 50 Ω
IMD3	IMD3	–	-115	-105	dBm	
Switching Time						
RF Rise Time	$t_{on/off}$	–	0.03	0.09	μs	10 % to 90 % RF ON; 90 % to 10 % RF OFF
Ctrl to RF Time	$t_{Ctrl-RF}$	–	0.18	0.25	μs	50 % of Ctrl Signal to 90 % of RF Signal

¹⁾With external shunt inductor

6 GPIO Specification

Table 8: Modes of Operation Truth Table

State	Mode	Control Inputs			RF1	RF2	RF3
		V1	V2				
1	Isolation	0	0		off	off	off
2	RFin - RF1	1	0		on	off	off
3	RFin - RF2	0	1		off	on	off
4	RFin - RF3	1	1		off	off	on

7 Pin Definition and Package Outline

Table 9: Pin Configuration

No	Name	Pin Type	Buffer Type	Function
1	V1	I		Control Pin 1
2	RF3	I/O		RF-Port3
3	RF1	I/O		RF-Port1
4	RFin	I/O		RF-Input
5	RF2	I/O		RF-Port2
6	DGND	GND		Digital Ground
7	VDD	PWR		Power Supply
8	V2	I		Control Pin 2
9	GND	GND		Digital Ground

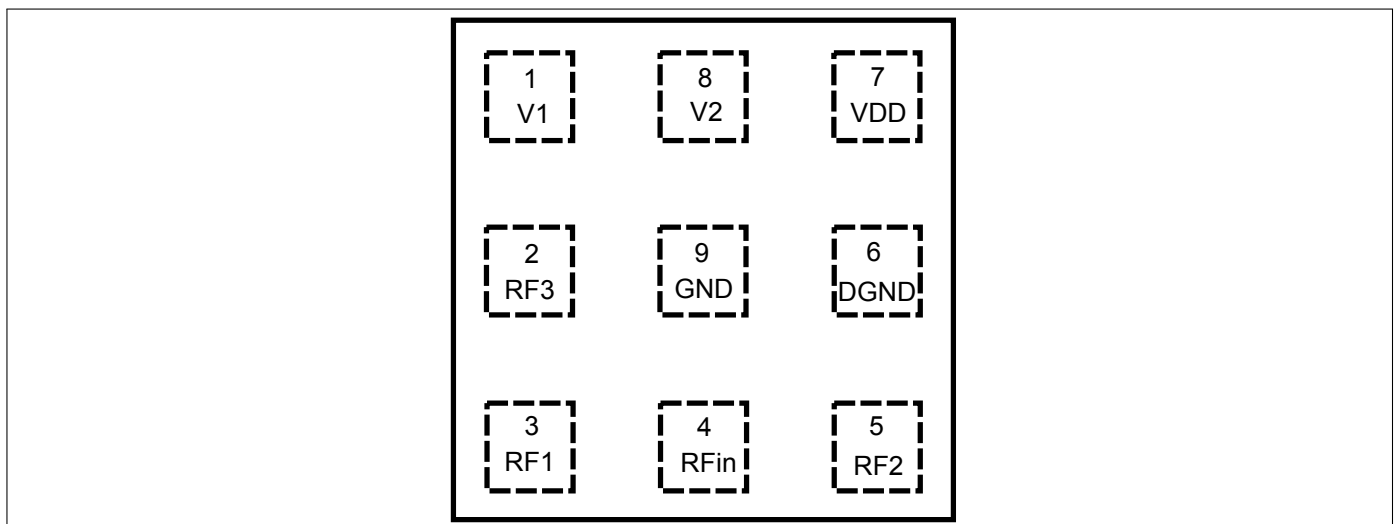

Figure 2: Pin out (top view)

Table 10: Mechanical Data

Parameter	Symbol	Value	Unit
X-Dimension	X	1.1 ± 0.05	mm
Y-Dimension	Y	1.1 ± 0.05	mm
Size	Size	1.21	mm ²
Height	H	0.375 ± 0.025	mm
Pad-Pitch		0.4	mm

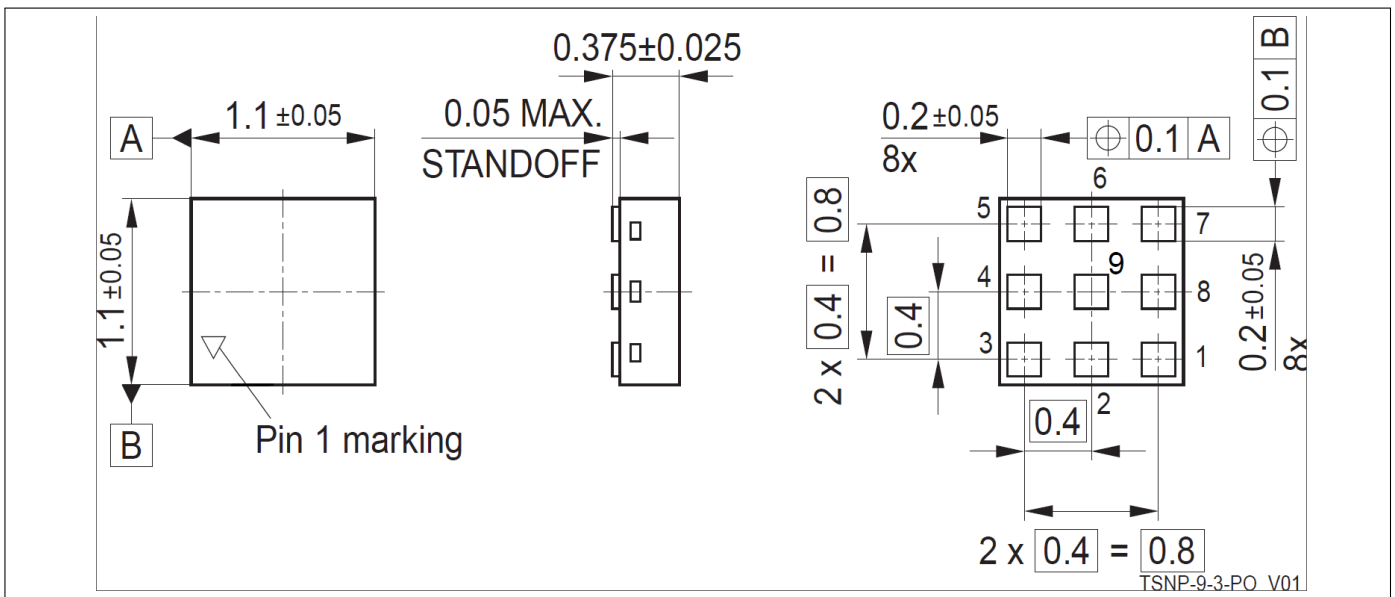

Figure 3: Package Outline (bottom and side view)

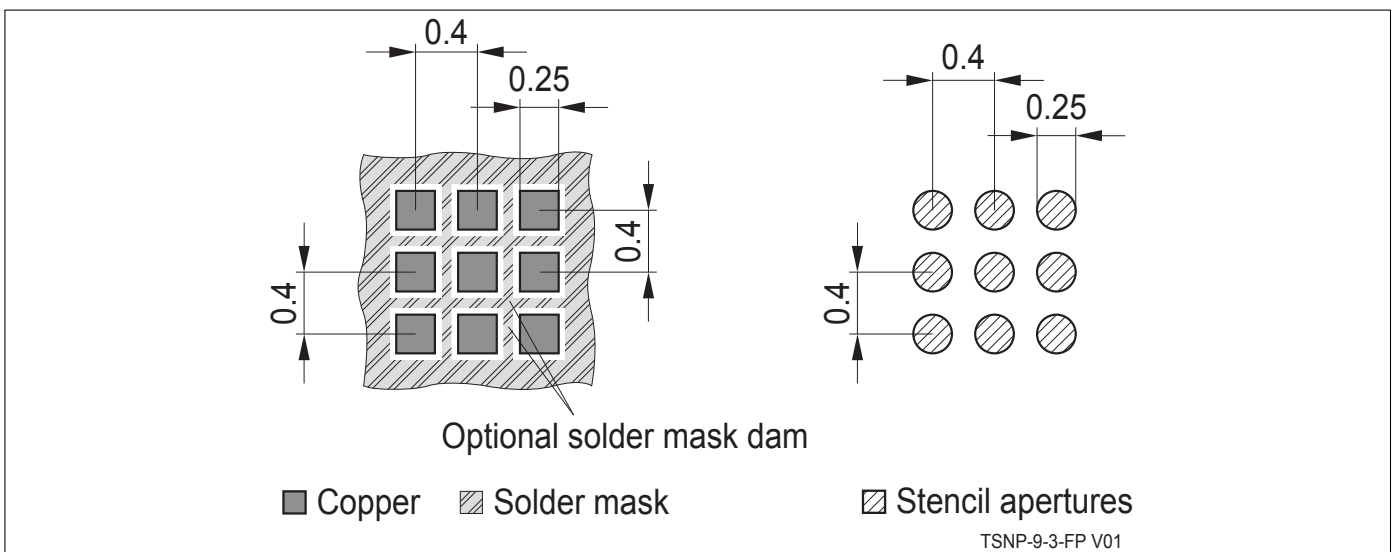

Figure 4: Land pattern and stencil mask

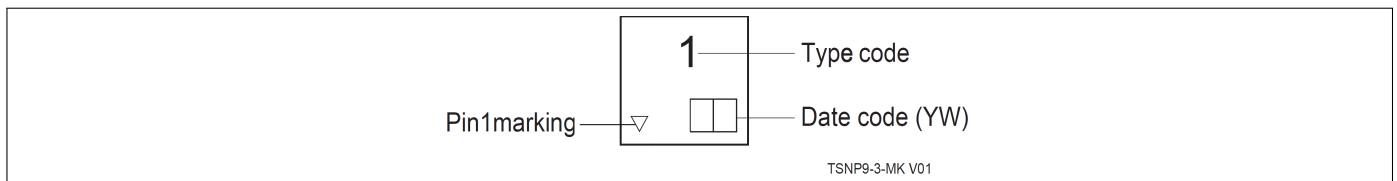

Figure 5: Marking Pattern

Table 11: Year date code marking - digit "Y"

Year	"Y"	Year	"Y"	Year	"Y"
2000	0	2010	0	2020	0
2001	1	2011	1	2021	1
2002	2	2012	2	2022	2
2003	3	2013	3	2023	3
2004	4	2014	4	2024	4
2005	5	2015	5	2025	5
2006	6	2016	6	2026	6
2007	7	2017	7	2027	7
2008	8	2018	8	2028	8
2009	9	2019	9	2029	9

Table 12: Week date code marking - digit "W"

Week	"W"	Week	"W"	Week	"W"	Week	"W"	Week	"W"
1	A	12	N	23	4	34	h	45	v
2	B	13	P	24	5	35	j	46	x
3	C	14	Q	25	6	36	k	47	y
4	D	15	R	26	7	37	l	48	z
5	E	16	S	27	a	38	n	49	8
6	F	17	T	28	b	39	p	50	9
7	G	18	U	29	c	40	q	51	2
8	H	19	V	30	d	41	r	52	3
9	J	20	W	31	e	42	s		
10	K	21	Y	32	f	43	t		
11	L	22	Z	33	g	44	u		

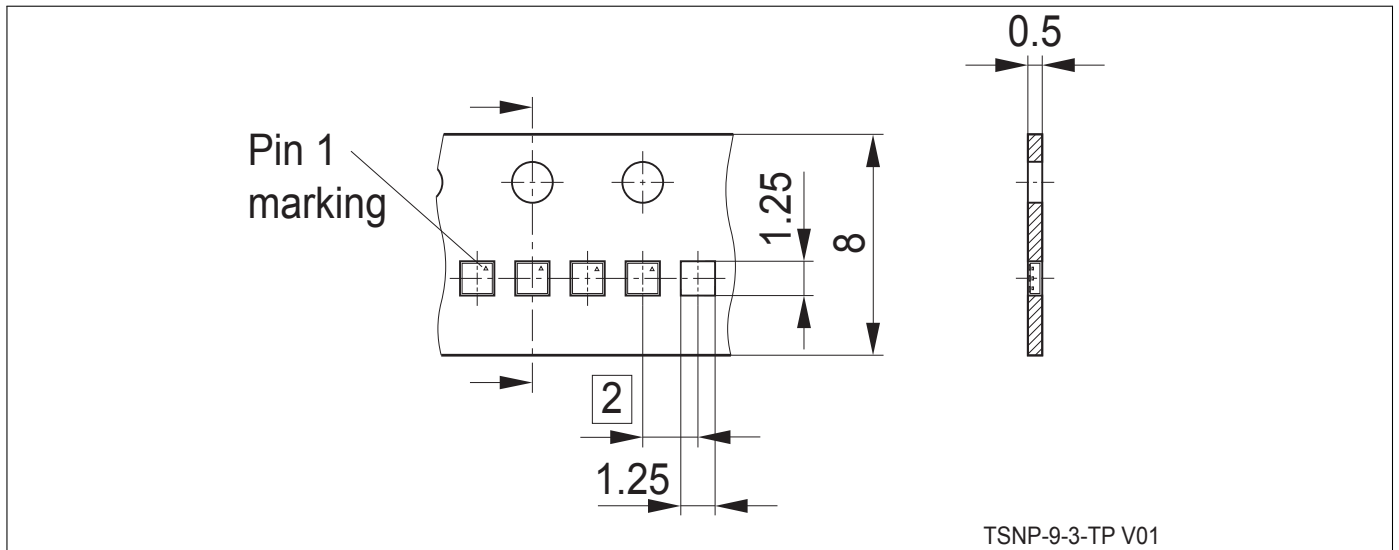

Figure 6: Tape and Reel (Reel ϕ 180 mm: 15.000 Pieces/Reel)

www.infineon.com

Published by Infineon Technologies AG