

UHF amplifier modules

BGY114A; BGY114B; BGY114C

FEATURES

- 12.5 V nominal supply voltage
- 6 W output power (BGY114A and BGY114B)
- 8 W output power (BGY114C)
- Easy control of output power by DC voltage.

APPLICATIONS

- Mobile cellular transmitting equipment operating in the 824 to 849 MHz (AMPS), 872 to 905 MHz (ETACS) and 890 to 915 MHz (NMT) frequency ranges.

PINNING - SOT278A

PIN	DESCRIPTION
1	RF input
2	V _{S1}
3	V _C
4	V _{S2}
5	RF output
flange	ground

DESCRIPTION

The BGY114A, BGY114B and BGY114C are five-stage amplifier modules.

Each module comprises five NPN silicon planar transistor chips mounted together with matching and bias circuit components on a metallized ceramic substrate.

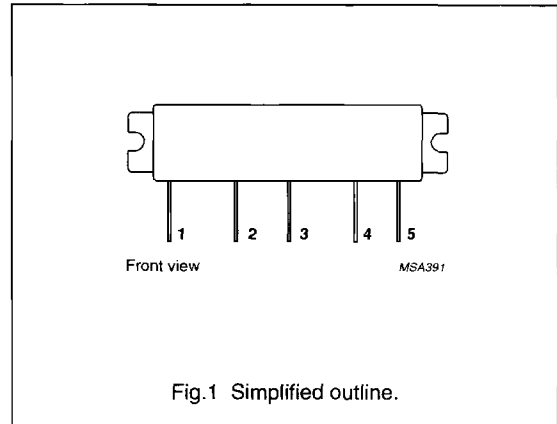

Fig.1 Simplified outline.

QUICK REFERENCE DATA

RF performance at $T_{mb} = 25\text{ }^{\circ}\text{C}$.

TYPE NUMBER	MODE OF OPERATION	f (MHz)	V _{S1} (V)	V _{S2} (V)	P _L (W)	G _p (dB)	η (%)	Z _S ; Z _L (Ω)
BGY114A	CW	824 to 849	8	12.5	6	≥ 37.8	typ. 40	50
BGY114B	CW	872 to 905	8	12.5	6	≥ 37.8	typ. 40	50
BGY114C	CW	890 to 915	8	12.5	8	≥ 39	typ. 40	50

WARNING

Product and environmental safety - toxic materials

This product contains beryllium oxide. The product is entirely safe provided that the BeO slab is not damaged. All persons who handle, use or dispose of this product should be aware of its nature and of the necessary safety precautions. After use, dispose of as chemical or special waste according to the regulations applying at the location of the user. It must never be thrown out with the general or domestic waste.

UHF amplifier modules

BGY114A; BGY114B; BGY114C

LIMITING VALUES

In accordance with the Absolute Maximum Rating System (IEC 134).

SYMBOL	PARAMETER	MIN.	MAX.	UNIT
V_{S1}	DC supply voltage	–	9	V
V_{S2}	DC supply voltage	–	16	V
V_C	DC control voltage	–	9	V
P_D	input drive power	–	3	mW
P_L	load power	–	10	W
T_{stg}	storage temperature	–40	+100	°C
T_{mb}	operating mounting base temperature	–30	+100	°C

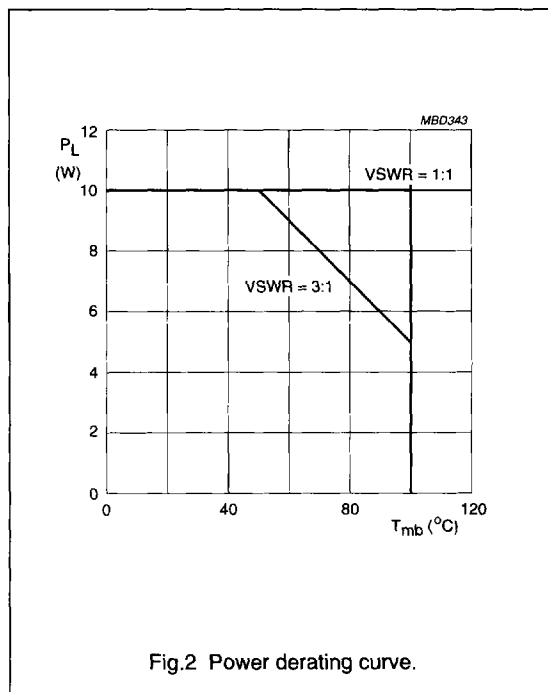

UHF amplifier modules

BGY114A; BGY114B; BGY114C

CHARACTERISTICS

$T_{mb} = 25\text{ }^{\circ}\text{C}$; $Z_S = Z_L = 50\text{ }\Omega$; $P_D = 1\text{ mW}$; $V_{S1} = 8\text{ V}$; $V_{S2} = 12.5\text{ V}$; $V_C \leq 8\text{ V}$; unless otherwise specified.

SYMBOL	PARAMETER	CONDITIONS	MIN.	TYP.	MAX.	UNIT
f	frequency					
	BGY114A		824	–	849	MHz
	BGY114B		872	–	905	MHz
	BGY114C		890	–	915	MHz
I_{Q5}	final stage leakage current	$V_{S1} = V_C = 0$; $P_D = 0$	–	–	1	mA
P_L	load power					
	BGY114A		6	–	–	W
	BGY114B		6	–	–	W
	BGY114C		8	–	–	W
G_p	power gain	note 1				
	BGY114A		37.8	–	–	dB
	BGY114B		37.8	–	–	dB
	BGY114C		39	–	–	dB
η	efficiency	note 1	35	40	–	%
H_2	second harmonic	note 1	–	–	–35	dBc
H_3	third harmonic	note 1	–	–	–35	dBc
$V_{SWR_{in}}$	input VSWR	note 1	–	–	2 : 1	
ΔG	gain control	$V_C = 0$ to 8 V	30	–		dB
	stability	$V_C = 0$ to 8 V; $V_{SWR} \leq 3 : 1$; $V_{S2} = 10$ to 16 V; note 2; $P_D = -3$ to +3 dBm	–	–	–60	dBc
	ruggedness	$V_{S2} = 16\text{ V}$; $V_{SWR} \leq 20 : 1$; note 2	no degradation			

Notes

1. Adjust V_C for $P_L = 6\text{ W}$ (BGY114A, BGY114B); $P_L = 8\text{ W}$ (BGY114C).
2. Adjust V_C for $P_L \leq 7\text{ W}$ (BGY114A, BGY114B); $P_L \leq 9\text{ W}$ (BGY114C).

UHF amplifier modules

BGY114A; BGY114B; BGY114C

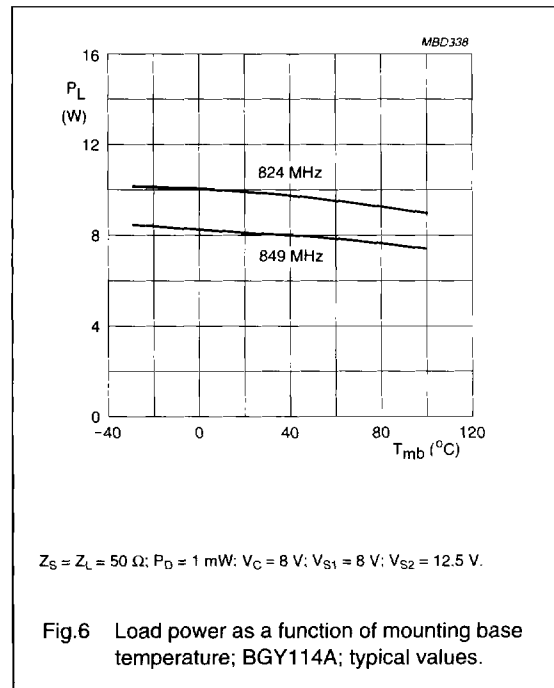
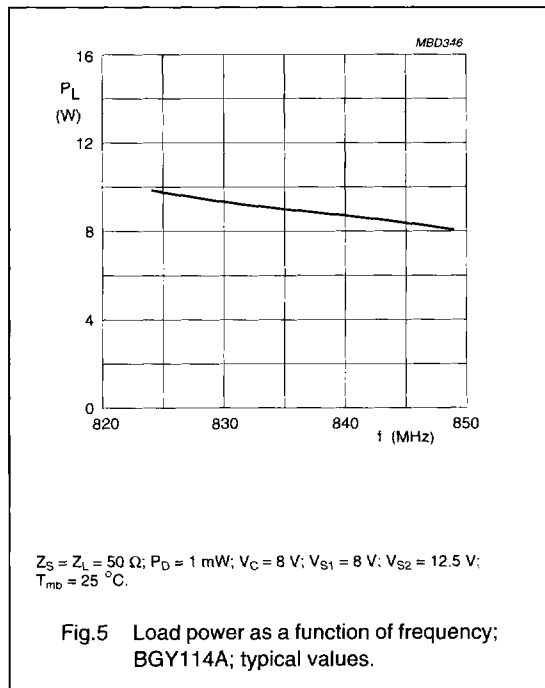
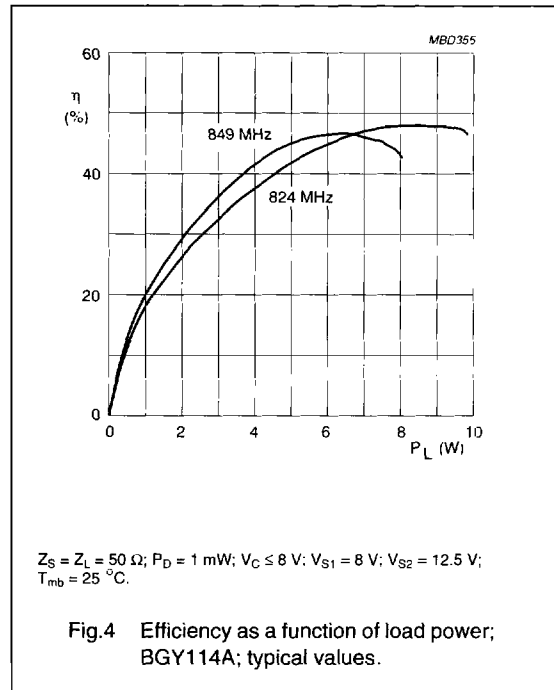
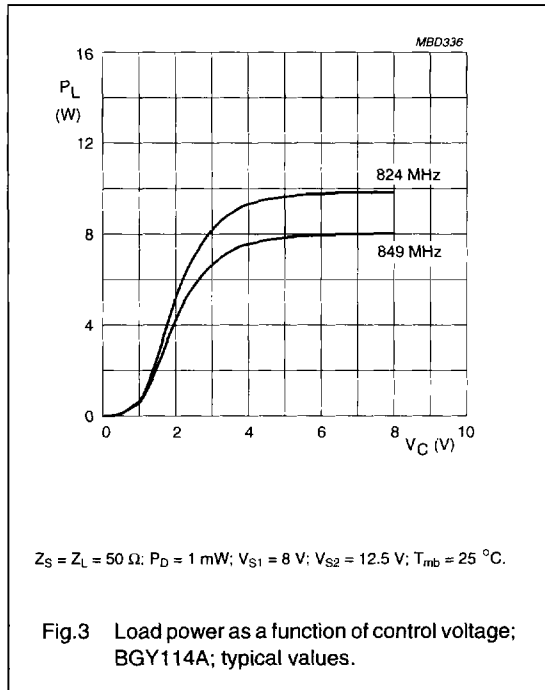

UHF amplifier modules

BGY114A; BGY114B; BGY114C

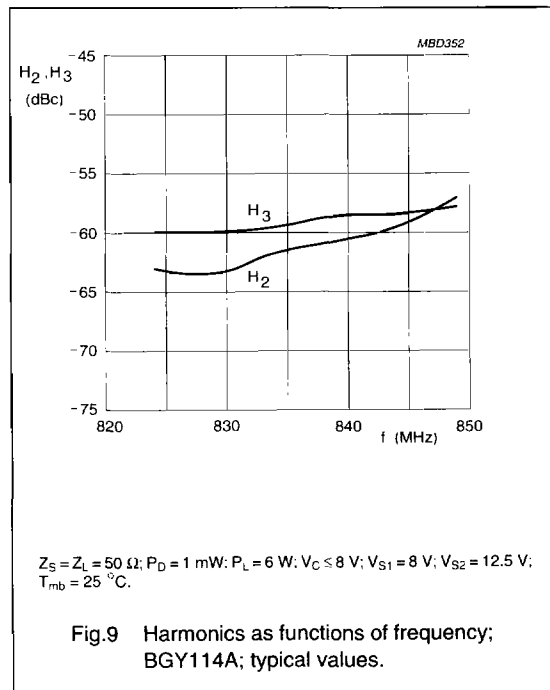
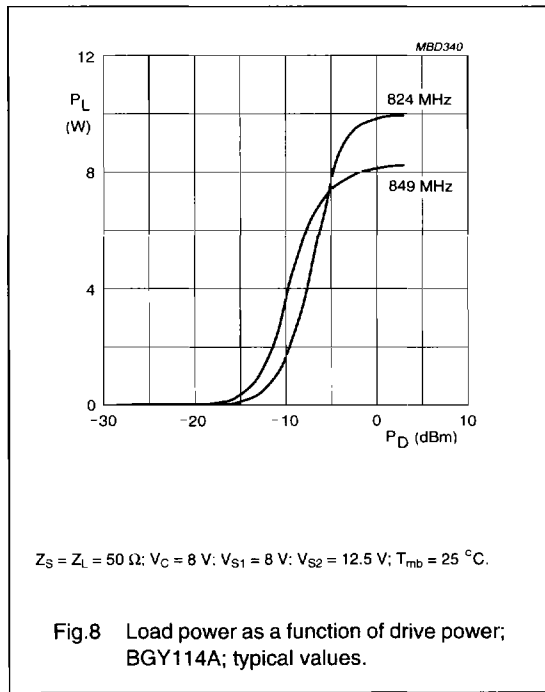
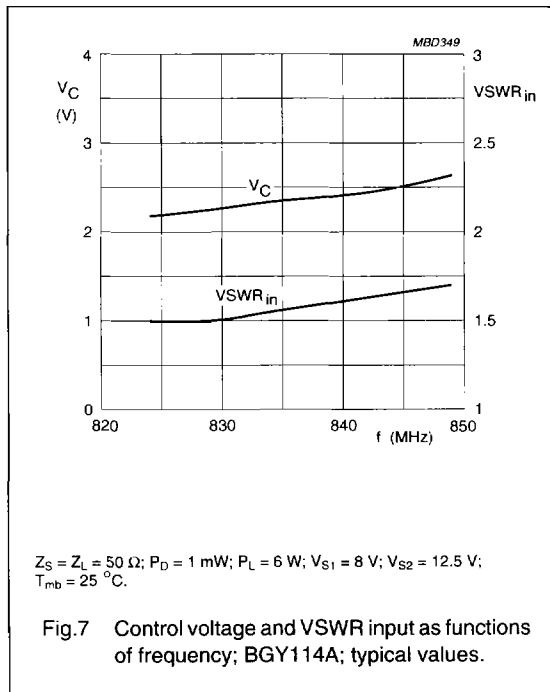

UHF amplifier modules

BGY114A; BGY114B; BGY114C

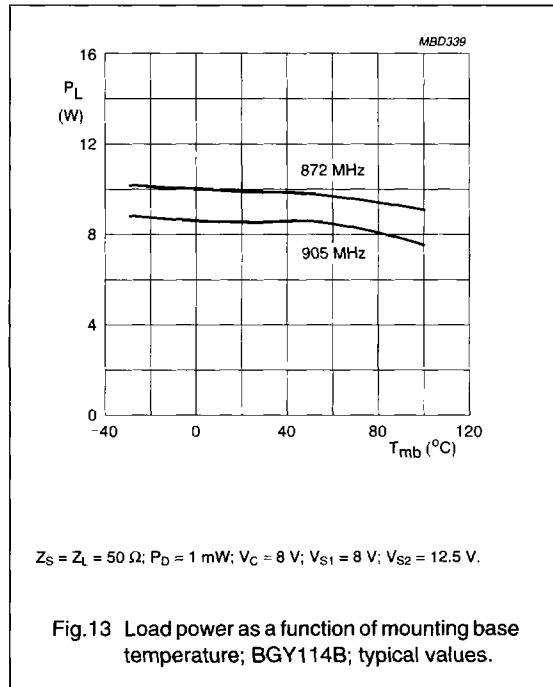
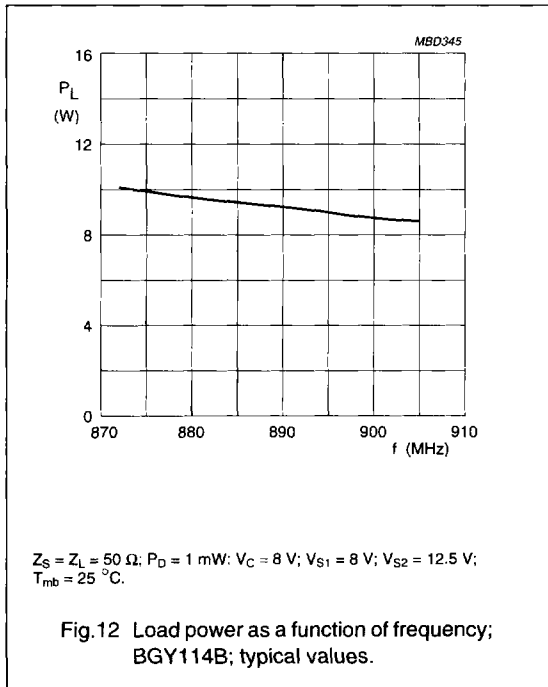
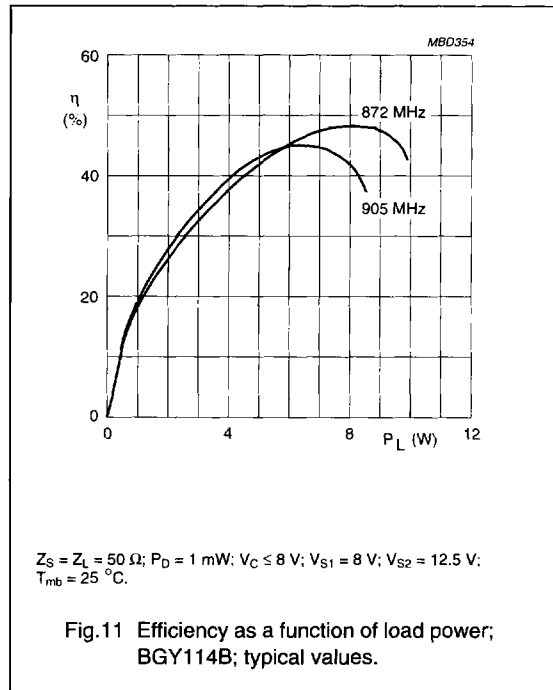
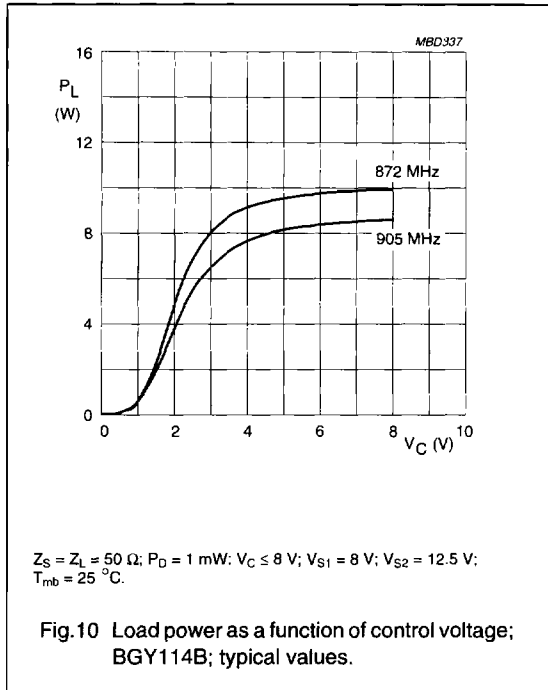

UHF amplifier modules

BGY114A; BGY114B; BGY114C

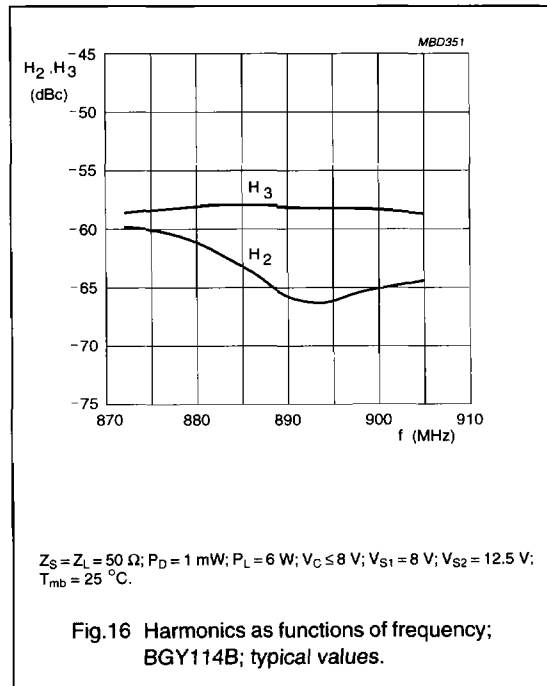
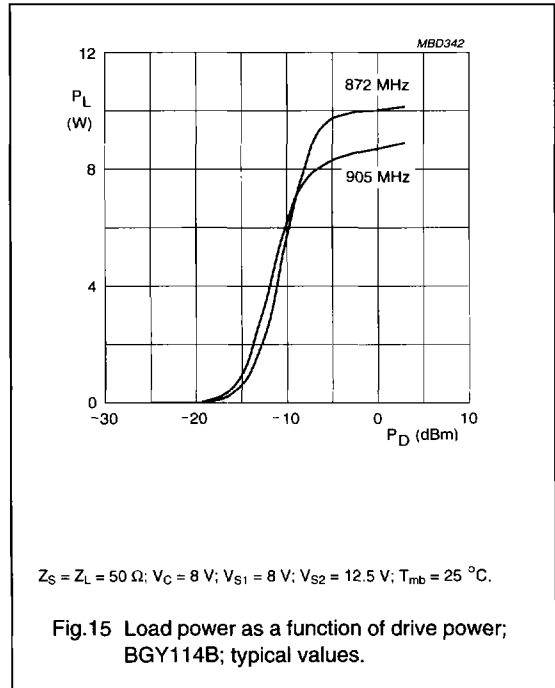
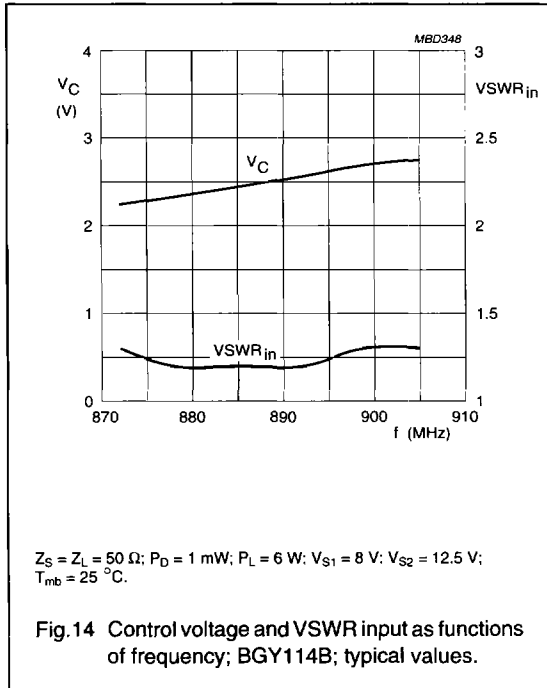

UHF amplifier modules

BGY114A; BGY114B; BGY114C

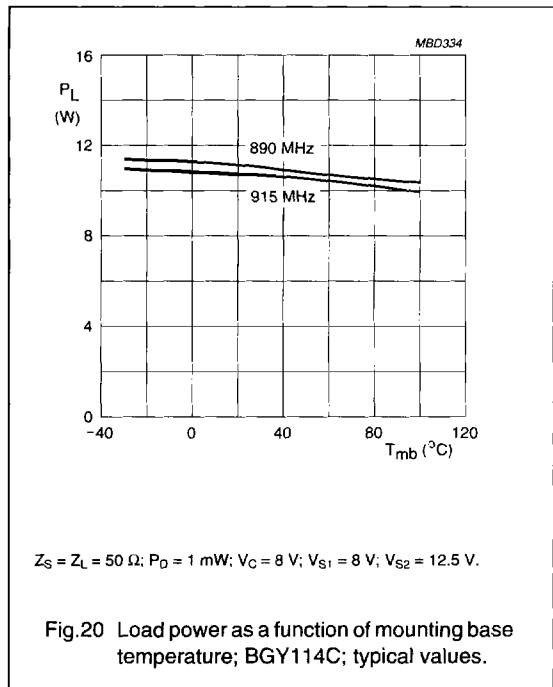
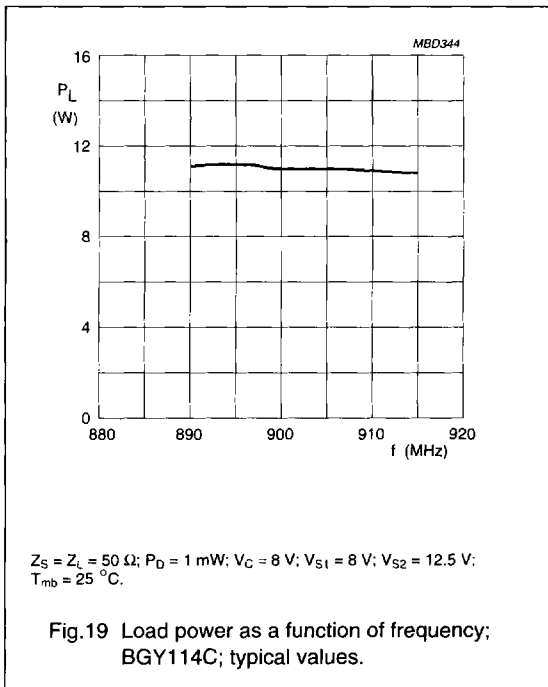
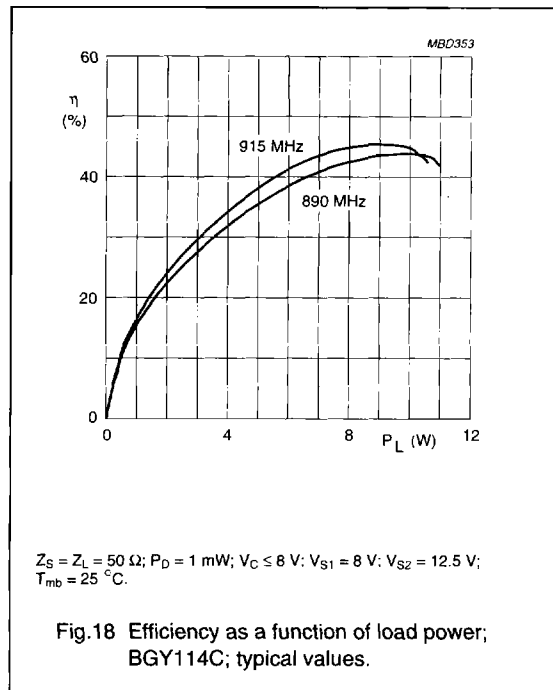
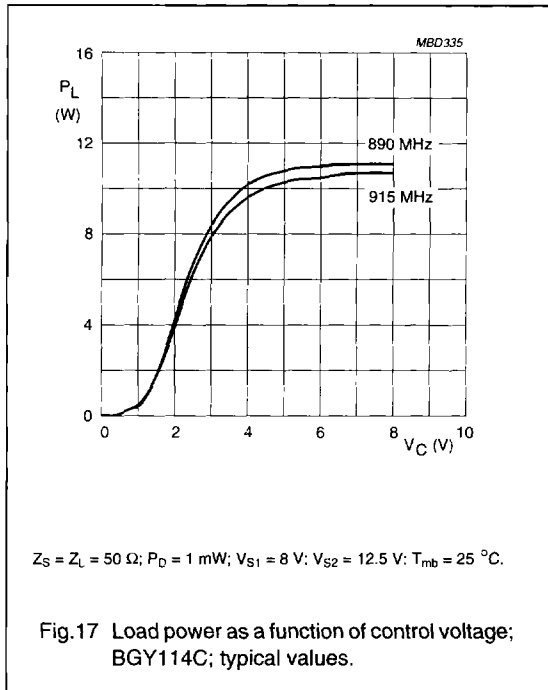

UHF amplifier modules

BGY114A; BGY114B; BGY114C

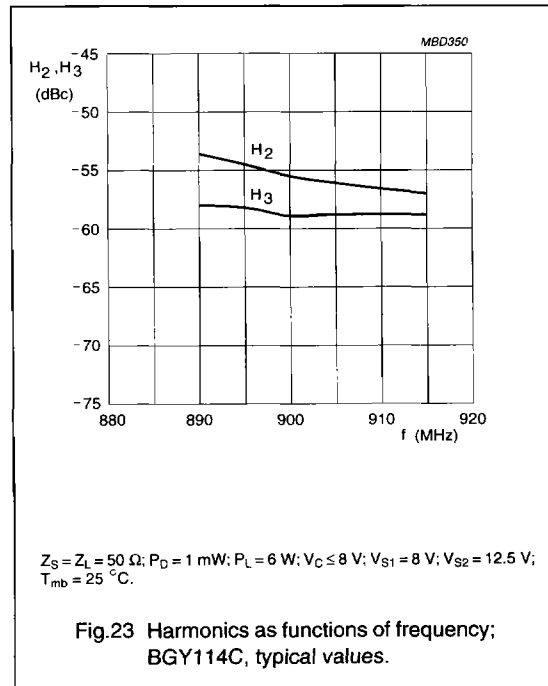
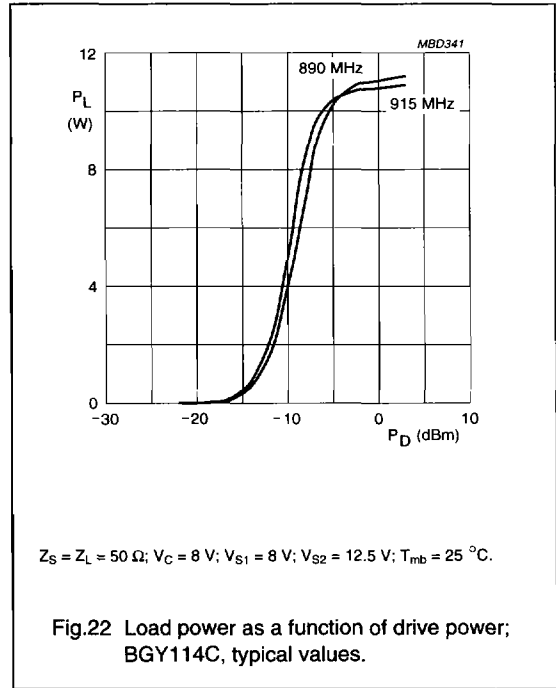
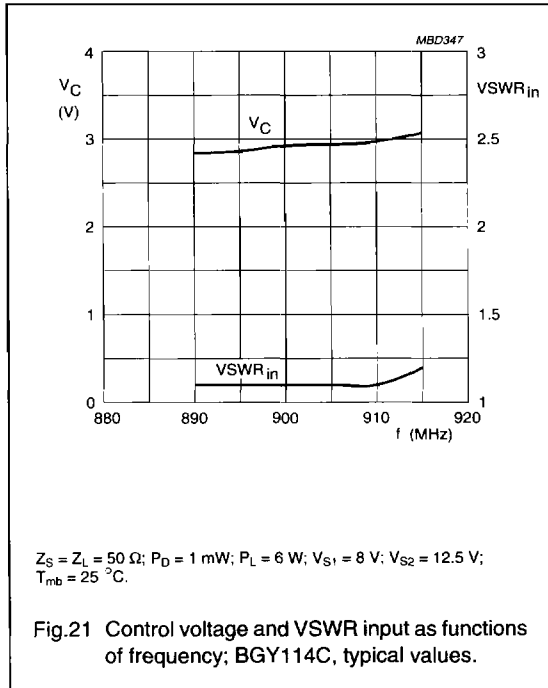

UHF amplifier modules

BGY114A; BGY114B; BGY114C

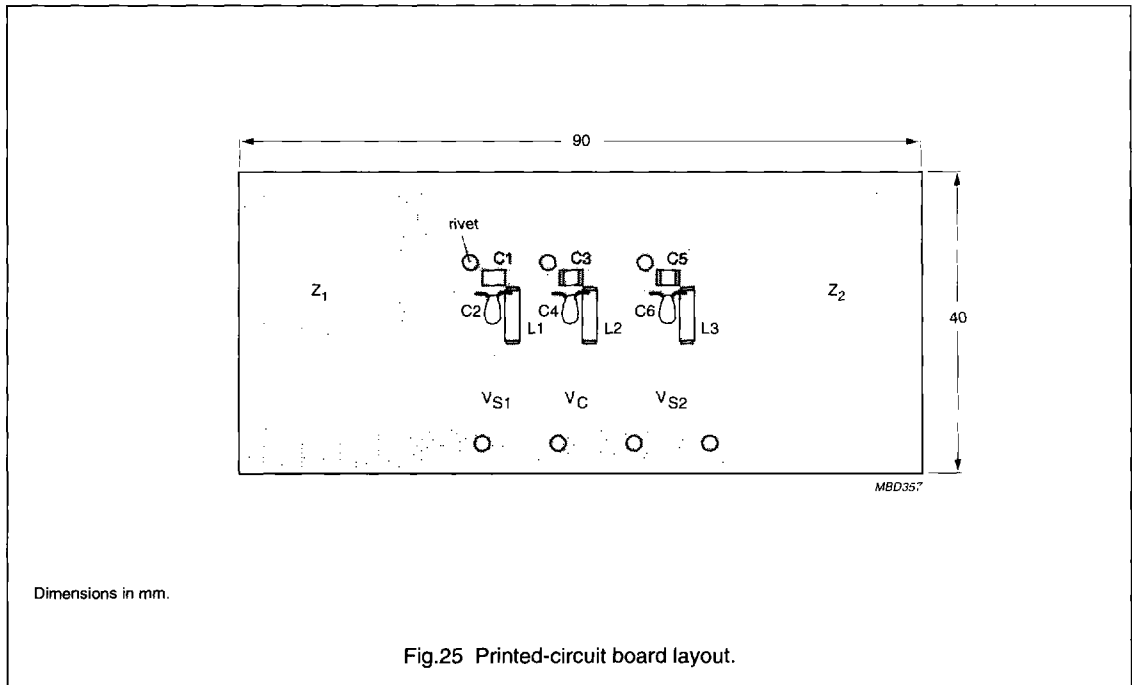
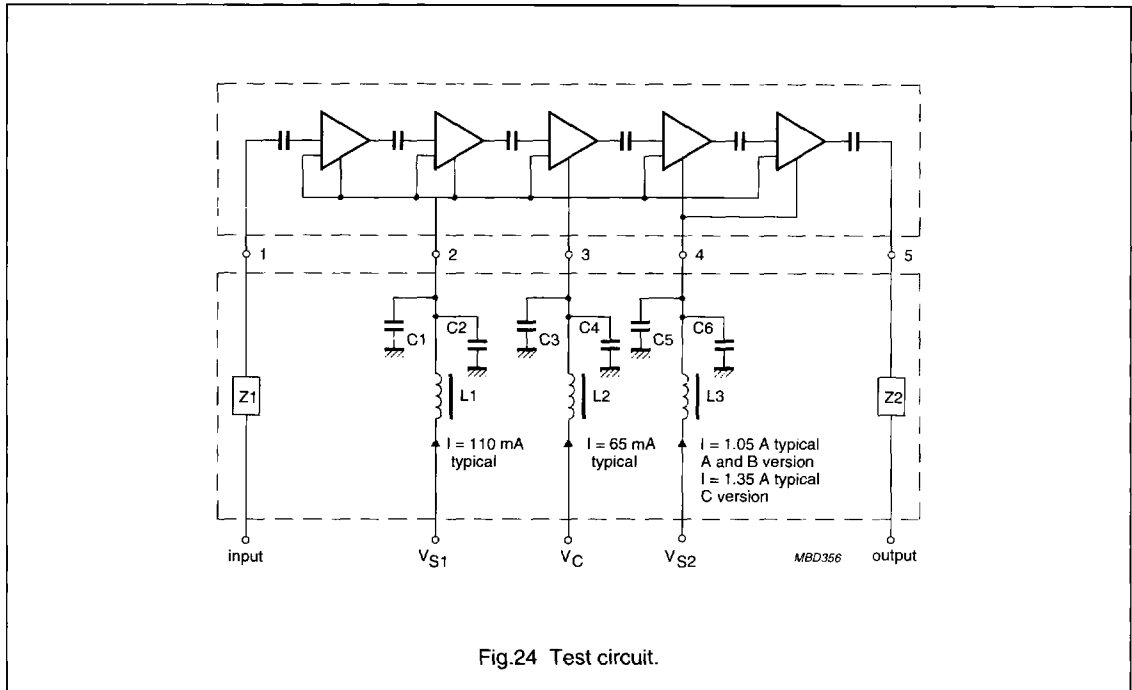

UHF amplifier modules

BGY114A; BGY114B; BGY114C

List of components (Figs 24 and 25)

COMPONENT	DESCRIPTION	VALUE	DIMENSION	CATALOGUE NO.
C1, C3, C5	multilayer ceramic chip capacitor; note 1	1 nF	–	–
C2, C4, C6	tantalum capacitor	1 μ F; 35 V	–	–
L1, L2, L3	Ferroxcube chip bead; grade 4S2	–	–	4330 030 36300
Z1, Z2	stripline; note 2	50 Ω	width 4.7 mm	–

Notes

1. ATC capacitor type 100B or capacitor of same quality.
2. The striplines are on a double copper-clad printed-circuit board with PTFE fibre-glass dielectric ($\epsilon_r = 2.2$); thickness $\frac{1}{16}$ inch.