

Dual-line serial control sound processor IC

BH3865S

The BH3865S is a signal processing IC developed for the control of volume and tone quality in TV equipment. Since dual-line serial control (I²C BUS) is used, the volume level and tone quality in TV equipment can be changed using signals such as those from a microcomputer or similar device.

Note : I²C BUS is a registered trademark of Philips.

●Applications

DVDs, personal computers, high-vision TVs, karaoke sets, digital broadcasts, CATVs, and other TV equipment

●Features

- 1) 2-channel volume and sound quality control.
- 2) Absorption of volume deviation between input sources and improved S / N ratio, for better sound quality, using an AGC circuit.
- 3) Control through I²C BUS serial control.
- 4) Internal pseudo-stereo circuit provides phase-shift matrix surround effect.

●Absolute maximum ratings (Ta = 25°C)

Parameter	Symbol	Limits	Unit
Power supply voltage	V _{CC}	10.0	V
Power dissipation	P _d	1250*	mW
Operating temperature	T _{opr}	-25~+75	°C
Storage temperature	T _{stg}	-55~+125	°C

*Reduced by 12.5mW for each increase in Ta of 1°C over 25°C.

●Recommended operating conditions (Ta = 25°C)

Parameter	Symbol	Min.	Typ.	Max.	Unit
Power supply voltage	V _{CC}	7.0	-	9.5	V

Video ICs

●Block diagram

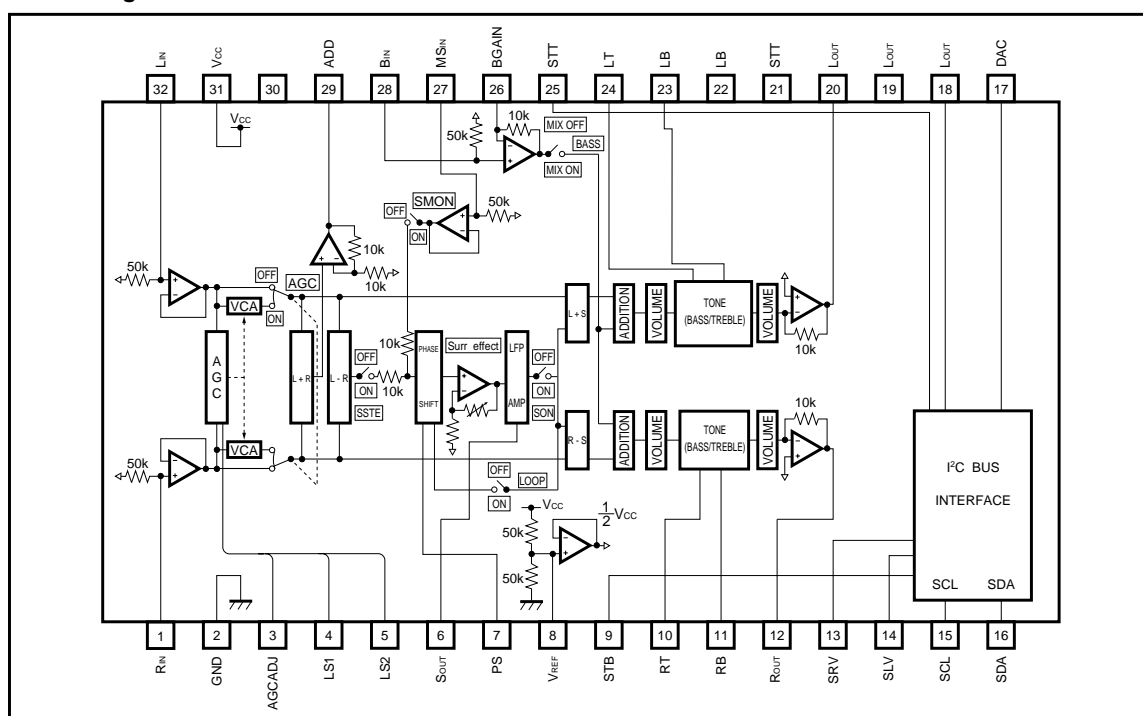

●Pin descriptions

Pin No.	Pin name	Function
1	R _{IN}	Rch input
2	GND	Ground
3	AGCADJ	AGC 0dB adjustment
4	LS1	AGC level sensor 1
5	LS2	AGC level sensor 2
6	S _{OUT}	Sch output pin and LPF
7	PS	Phase shift pin (internal resistance:18kΩ)
8	V _{REF}	1 / 2 V _{CC}
9	STB	Bass shock sound integration
10	RT	Rch Treble fc setting
11	RB	Rch Bass fc setting
12	R _{OUT}	Rch output
13	SRV	Vol Rch shock sound integration
14	SLV	Vol Lch shock sound integration
15	SCL	I ² C communications clock
16	SDA	I ² C communications data

Pin No.	Pin name	Function
17	DAC	Expansion DAC (L / H)
18	N.C.	No connection
19	N.C.	No connection
20	L _{OUT}	Lch output
21	N.C.	No connection
22	N.C.	No connection
23	LB	Lch Bass fc setting
24	LT	Lch Treble fc setting
25	STT	Treble shock sound integration
26	BGAIN	Bass Mix Gain adjustment
27	MS _{IN}	Mono Sur input
28	B _{IN}	Bass detection LPF operating amplifier input
29	ADD	L + R added output after AGC
30	N.C.	No connection
31	V _{CC}	Power supply, 9V
32	L _{IN}	Lch input

Video ICs

● Input / output circuits

Pin No.	Pin name	Pin voltage	Z _{IN}	I / O	Equivalent circuit	Function
1 32	R _{IN} L _{IN}	4.5V	50k	I		Input pins.
12 20	R _{OUT} L _{OUT}	4.5V	-	O		Output pins.
3	AGCADJ	-	-	I		AGC 0dB adjustment pin. This pin is connected to the base of PNP. The current output from this pin is 1μA (Typ.) Max.
4	LS1	-	-	-		Time constant pin on the side that suppresses the AGC signal level.

Video ICs

Pin No.	Pin name	Pin voltage	Z _{IN}	I / O	Equivalent circuit	Function
5	LS2	-	-	-		Time constant pin on the side that amplifies the AGC signal level.
6	S _{OUT}	4.5V	10k	O		Serves as both the output pin for the surround and pseudo-stereo effects, and the LPF pin.
7	PS	-	-	-		For the phase-shifter filter for the surround and pseudo-stereo effects.
8	V _{ref}	4.5V	-	-		1 / 2 V _{cc} . This voltage serves as the power supply for the signal system.

Video ICs

Pin No.	Pin name	Pin voltage	Z _{IN}	I / O	Equivalent circuit	Function
9 25	STB STT	-	30k	-		Integration pins that prevent shock sound when switching the bass and treble levels.
10 24	RT LT	4.5V	30k	-		Treble filter pins for the left and right channels.
11 23	RB LB	4.5V	30k	-		Bass filter pins for the left and right channels.
13 14	SRV SLV	-	30k	-		Integration pins that prevent shock sound when switching the volume levels on the left and right channels.

Video ICs

Pin No.	Pin name	Pin voltage	Z _{IN}	I / O	Equivalent circuit	Function
15	SCL	-	-	I		SCL pin for the I ² C BUS. This is the clock pin.
16	SDA	-	-	I		SDA pin for the I ² C BUS. The Acknowledge signal is output from this pin. This is the data pin.
17	DAC	0 / 5	-	O		0V and 5V output pin that enables control with the I ² C BUS.
26	BGAIN	4.5V	-	-		Gain adjustment pin used to mix the bass on the left and right channels.

Video ICs

Pin No.	Pin name	Pin voltage	Z _{IN}	I / O	Equivalent circuit	Function
27	MS _{IN}	4.5V	50k	I		Surround input section for monaural signals in the surround section.
28	B _{IN}	4.5V	50k	I		Bass signal input to the left and right channels.
29	ADD	4.5V	-	O		Incremented output from the left and right channels following AGC.
31	V _{CC}	9V	-	-	-	Power supply pin.
2	GND	0V	-	-	-	Ground pin.

Video ICs

●Electrical characteristics (unless otherwise noted, Ta = 25°C, V_{CC} = 9V, f = 1kHz, R_g = 600Ω, R_L = 10kΩ)

Parameter	Symbol	Min.	Typ.	Max.	Unit	Conditions
Quiescent circuit current	I _Q	-	27	45	mA	V _{IN} =0V _{rms}
Max. output voltage, Rch	V _{OMR}	2.1	2.5	-	V _{rms}	THD=1% (C)
Max. output voltage, Lch	V _{OML}	2.1	2.5	-	V _{rms}	THD=1% (C)
Voltage gain, Rch	G _{VR}	-1.5	0	1.5	dB	V _{IN} =1V _{rms} , G _{VR} =20log (B) / V _{IN}
Voltage gain, Lch	G _{VL}	-1.5	0	1.5	dB	V _{IN} =1V _{rms} , G _{VL} =20log (B) / V _{IN}
Total harmonic distortion, Rch	THD _R	-	0.01	0.1	%	V _{IN} =1V _{rms}
Total harmonic distortion, Lch	THD _L	-	0.01	0.1	%	V _{IN} =1V _{rms}
Output noise voltage, Rch	V _{NOR}	-	35	70	μV _{rms}	R _g =0Ω, DIN AUDIO
Output noise voltage, Lch	V _{NOL}	-	35	70	μV _{rms}	R _g =0Ω, DIN AUDIO
Residual noise voltage, Rch	V _{MNOR}	-	3	10	μV _{rms}	R _g =0Ω, DIN AUDIO
Residual noise voltage, Lch	V _{MNOL}	-	3	10	μV _{rms}	R _g =0Ω, DIN AUDIO
Crosstalk, Rch→Lch	CT _{R-L}	70	78	-	dB	V _{IN} =1V _{rms} , CT _{R-L} =20log (B) _R / (B) _L
Crosstalk, Lch→Rch	CT _{L-R}	70	78	-	dB	V _{IN} =1V _{rms} , CT _{L-R} =20log (B) _L / (B) _R
Input impedance, Rch	R _{INR}	35	50	65	kΩ	f _{INR} =1kHz, V _{IN} =1V _{rms} , R _{INR} = $\frac{50k \times (A)}{(1 - A)}$
Input impedance, Lch	R _{INL}	35	50	65	kΩ	f _{INL} =1kHz, V _{IN} =1V _{rms} , R _{INL} = $\frac{50k \times (A)}{(1 - A)}$
Output impedance, Rch	R _{OUTR}	-	-	50	Ω	f _{OUTR} =1kHz, R _{OUTR} = $\frac{1k \times (D)}{1 - (D)}$
Output impedance, Lch	R _{OUTL}	-	-	50	Ω	f _{OUTL} =1kHz, R _{OUTL} = $\frac{1k \times (D)}{1 - (D)}$
Ripple rejection, Rch	RR _R	40	53	-	dB	f _{RR} =100Hz, V _{RR} =100mV _{rms} , RR _R =20log $\frac{V_{RR}}{(B)}$
Ripple rejection, Lch	RR _L	40	53	-	dB	f _{RR} =100Hz, V _{RR} =100mV _{rms} , RR _L =20log $\frac{V_{RR}}{(B)}$
Muting level, Rch	V _{MUTER}	80	90	-	dB	V _{IN} =1V _{rms} , V _{MUTER} =20log $\frac{V_{IN}}{(B)}$
Muting level, Lch	V _{MUTEL}	80	90	-	dB	V _{IN} =1V _{rms} , V _{MUTEL} =20log $\frac{V_{IN}}{(B)}$
Volume attenuation, Rch	ATT _{MAXR}	80	90	-	dB	V _{IN} =1V _{rms} , ATT _{MAXR} =20log $\frac{V_{IN}}{(B)}$
Volume attenuation, Lch	ATT _{MAXL}	80	90	-	dB	V _{IN} =1V _{rms} , ATT _{MAXL} =20log $\frac{V_{IN}}{(B)}$
Channel balance 1, Rch→Lch	CB _{1R-L}	-1.5	0	1.5	dB	V _{IN} =1V _{rms} , CB _{1R-L} =20log $\frac{(B)_R}{(B)_L}$
Channel balance 2, Rch→Lch	CB _{2R-L}	-2.0	0	2.0	dB	V _{IN} =1V _{rms} , CB _{2R-L} =20log $\frac{(B)_R}{(B)_L}$
Bass boost gain, Rch	VB _{MAXR}	13	15.5	18	dB	Comparison with f=100Hz, V _{IN} =100mV _{rms} , bass flat
Bass boost gain, Lch	VB _{MAXL}	13	15.5	18	dB	Comparison with f=100Hz, V _{IN} =100mV _{rms} , bass flat
Bass cut gain, Rch	VB _{MINR}	-18	-15.5	-13	dB	Comparison with f=100Hz, V _{IN} =100mV _{rms} , bass flat
Bass cut gain, Lch	VB _{MINL}	-18	-15.5	-13	dB	Comparison with f=100Hz, V _{IN} =100mV _{rms} , bass flat
Treble boost gain, Rch	VT _{MAXR}	9	12	15	dB	Comparison with f=10kHz, V _{IN} =100mV _{rms} , bass flat
Treble boost gain, Lch	VT _{MAXL}	9	12	15	dB	Comparison with f=10kHz, V _{IN} =100mV _{rms} , bass flat

Video ICs

Parameter	Symbol	Min.	Typ.	Max.	Unit	Conditions
Treble cut gain, Rch	VT _{MINR}	-15	-12	-9	dB	Comparison with f=10kHz, V _{IN} =100mVrms, bass flat
Treble cut gain, Lch	VT _{MINL}	-15	-12	-9	dB	Comparison with f=10kHz, V _{IN} =100mVrms, bass flat
AGC input / output level 1, Rch	V _{AGC1R}	0.7	1	1.4	mVrms	V _{IN} =1mVrms
AGC input / output level 1, Lch	V _{AGC1L}	0.7	1	1.4	mVrms	V _{IN} =1mVrms
AGC input / output level 2, Rch	V _{AGC2R}	50	80	110	mVrms	V _{IN} =50mVrms
AGC input / output level 2, Lch	V _{AGC2L}	50	80	110	mVrms	V _{IN} =50mVrms
AGC input / output level 3, Rch	V _{AGC3R}	90	130	170	mVrms	V _{IN} =110mVrms
AGC input / output level 3, Lch	V _{AGC3L}	90	130	170	mVrms	V _{IN} =110mVrms
AGC input / output level 4, Rch	V _{AGC4R}	160	210	260	mVrms	V _{IN} =1Vrms
AGC input / output level 4, Lch	V _{AGC4L}	160	210	260	mVrms	V _{IN} =1Vrms
Total harmonic distortion at AGC ON, Rch	THD _{AGCR}	-	0.4	1	%	V _{IN} =200mVrms
Total harmonic distortion at AGC ON, Lch	THD _{AGCL}	-	0.4	1	%	V _{IN} =200mVrms
Max. surround gain, Rch	V _{SUMAXR}	4	6	8	dB	V _{IN} =100mVrms, V _{SUMAXR} =20log ⓑ / V _{IN}
Max. surround gain, Lch	V _{SUMAXL}	4	6	8	dB	V _{IN} =100mVrms, V _{SUMAXL} =20log ⓑ / V _{IN}
Min. surround gain, Rch	V _{SUMINR}	0	1	3.5	dB	V _{IN} =100mVrms, V _{SUMINR} =20log ⓑ / V _{IN}
Min. surround gain, Lch	V _{SUMINL}	0	1	3.5	dB	V _{IN} =100mVrms, V _{SUMINL} =20log ⓑ / V _{IN}
Surround gain at Loop ON, Rch	V _{LPSUR}	1.5	4	6.5	dB	V _{IN} =100mVrms, V _{LPSUR} =20log ⓑ / V _{IN}
Surround gain at Loop ON, Lch	V _{LPSUL}	1.5	4	6.5	dB	V _{IN} =100mVrms, V _{LPSUL} =20log ⓑ / V _{IN}
Bass Add ON gain, Rch	V _{BAONR}	7.5	10	12.5	dB	f=100Hz, V _{IN} =100mVrms, V _{BAONR} =20log ⓑ / V _{IN}
Bass Add ON gain, Lch	V _{BAONL}	7.5	10	12.5	dB	f=100Hz, V _{IN} =100mVrms, V _{BAONL} =20log ⓑ / V _{IN}
Pseudo-stereo gain, Rch	V _{MONR}	-6.5	-4	-1.5	dB	V _{IN} =100mVrms, V _{MONR} =20log ⓑ / V _{IN}
Pseudo-stereo gain, Lch	V _{MONL}	1.5	4	6.5	dB	V _{IN} =100mVrms, V _{MONL} =20log ⓑ / V _{IN}
DAC pin operating voltage 1	V _{DAC1}	4.7	5	5.3	V	
DAC pin operating voltage 2	V _{DAC2}	-	0	0.3	V	
SCL and SDA pin input high level	V _{IHI}	3.5	-	5	V	
SCL and SDA pin input low level	V _{ILO}	-	-	0.9	V	

*The phase are the same between the input and output signal pins.

Video ICs

● Measurement circuit

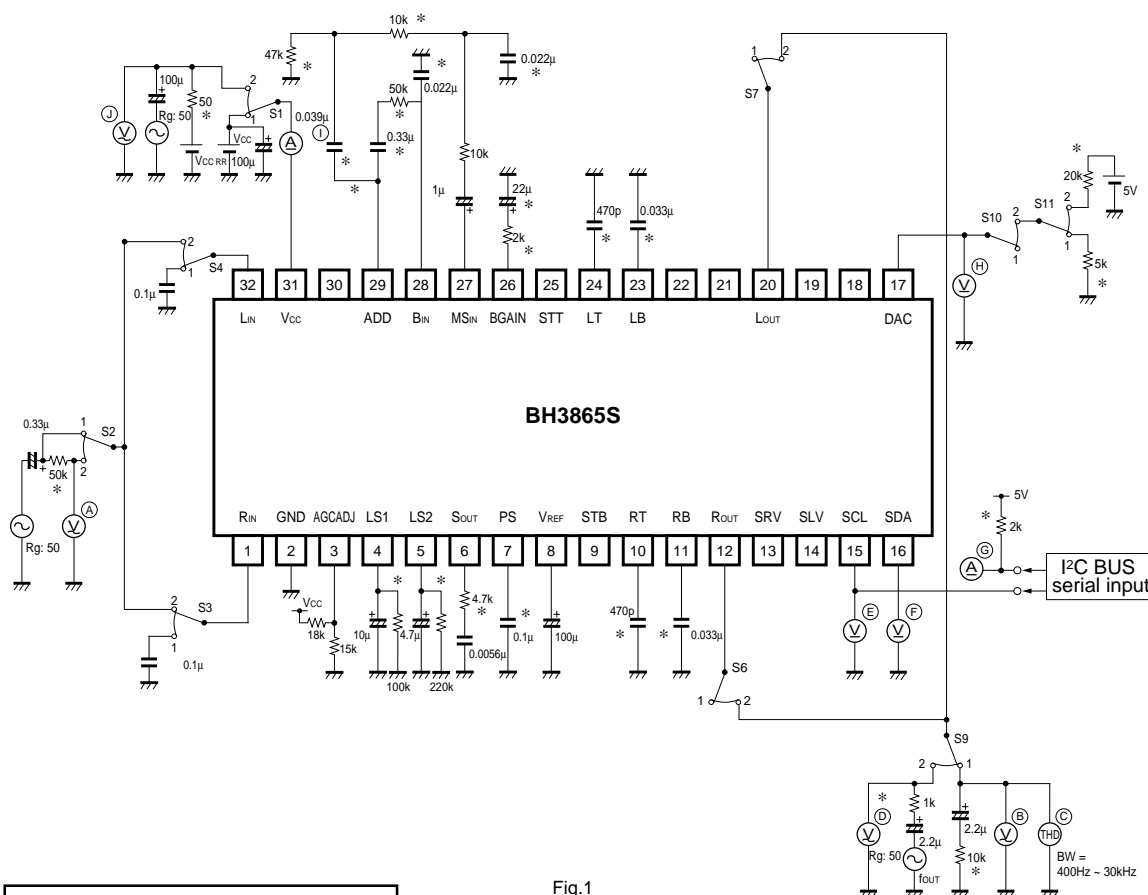
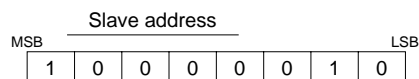

Fig.1

- Recommended attachments**
- 1) Elements marked with an asterisk
 - Carbon-sheathed resistors : ±1%
 - Film capacitors : ±1%
 - Ceramic capacitors : ±1%
 - 2) Unless otherwise noted, the following attachments should be used.
 - Carbon-sheathed resistors : ±5%
 - Film capacitors : ±20%

- Precautions concerning wiring**
- 1) A bare ground should be used for GND.
 - 2) The wiring pattern of the I²C BUS should be separate from that of the analog unit, to avoid crosstalk.
 - 3) Parallel positioning of the SCL and SDA lines of the I²C BUS should be avoided wherever possible. If they are adjacent, they should be shielded.

● Measurement circuit switch operation



Parameter	Symbol	SW No.											I ² C BUS						Measurement point							
		1	2	3	4	5	6	7	8	9	10	11	Selected address / data													
												0	0	0	1	0	2	0	3	0	4	0	5	0	6	
Quiescent circuit current	I _Q	1	—	1	1	—	1	1	—	—	1	F	F	F	F	—	—	2	0	2	0	0	0	0	C	①
Max. output voltage, Rch	V _{OMR}	1	1	2	1	—	2	1	—	1	1	0	0	F	F	—	—	2	0	2	0	0	0	0	C	②
Max. output voltage, Lch	V _{OML}	1	1	1	2	—	1	2	—	1	1	F	F	0	0	—	—	2	0	2	0	0	0	0	C	③
Voltage gain, Rch	G _{VR}	1	1	2	1	—	2	1	—	1	1	0	0	F	F	—	—	2	0	2	0	0	0	0	C	④
voltage gain, Lch	G _{VL}	1	1	1	2	—	1	2	—	1	1	F	F	0	0	—	—	2	0	2	0	0	0	0	C	⑤



Video ICs

Parameter	Symbol	SW NO.											I ² C BUS						Measurement point								
													Selected address / data														
		1	2	3	4	5	6	7	8	9	10	11	0	0	0	1	0	2		0	3	0	4	0	5	0	6
Total harmonic distortion, Rch	THDR	1	1	2	1	—	2	1	—	1	1	—	0	0	F	F	—	—	2	0	2	0	0	0	0	C	
Total harmonic distortion, Lch	THDL	1	1	1	2	—	1	2	—	1	1	—	F	F	0	0	—	—	2	0	2	0	0	0	0	C	
Output noise voltage, Rch	V _{NOR}	1	1	1	1	—	2	1	—	1	1	—	0	0	F	F	—	—	2	0	2	0	0	0	0	C	
Output noise voltage, Lch	V _{NOL}	1	1	1	1	—	1	2	—	1	1	—	F	F	0	0	—	—	2	0	2	0	0	0	0	C	
Residual noise voltage, Rch	V _{MNOR}	1	1	1	1	—	2	1	—	1	1	—	0	0	0	0	—	—	2	0	2	0	0	0	0	C	
Residual noise voltage, Lch	V _{MNOL}	1	1	1	1	—	1	2	—	1	1	—	0	0	0	0	—	—	2	0	2	0	0	0	0	C	
Crosstalk, Rch→Lch	CT _{R-L}	1	1	2	1	—	1	2	—	1	1	—	F	F	F	F	—	—	2	0	2	0	0	0	0	C	
Crosstalk, Lch→Rch	CT _{L-R}	1	1	1	2	—	2	1	—	1	1	—	F	F	F	F	—	—	2	0	2	0	0	0	0	C	
Input impedance, Rch	R _{INR}	1	2	2	1	—	1	1	—	1	1	—	0	0	0	0	—	—	2	0	2	0	0	0	0	C	
Input impedance, Lch	R _{INL}	1	2	1	2	—	1	1	—	1	1	—	0	0	0	0	—	—	2	0	2	0	0	0	0	C	
Output impedance, Rch	R _{OUTR}	1	1	1	1	—	2	1	—	2	1	—	0	0	0	0	—	—	2	0	2	0	0	0	0	C	
Output impedance, Lch	R _{OUTL}	1	1	1	1	—	1	2	—	2	1	—	0	0	0	0	—	—	2	0	2	0	0	0	0	C	
Ripple rejection, Rch	RR _R	2	1	1	1	—	2	1	—	1	1	—	0	0	F	F	—	—	2	0	2	0	0	0	0	C	
Ripple rejection, Lch	RR _L	2	1	1	1	—	1	2	—	1	1	—	F	F	0	0	—	—	2	0	2	0	0	0	0	C	
Muting level, Rch	V _{MUTER}	1	1	2	1	—	2	1	—	1	1	—	F	F	F	F	—	—	2	0	2	0	0	0	0	E	
Muting level, Lch	V _{MUTEL}	1	1	1	2	—	1	2	—	1	1	—	F	F	F	F	—	—	2	0	2	0	0	0	0	E	
Volume attenuation, Rch	ATT _{MAXR}	1	1	2	1	—	2	1	—	1	1	—	0	0	0	0	—	—	2	0	2	0	0	0	0	C	
Volume attenuation, Lch	ATT _{MAXL}	1	1	1	2	—	1	2	—	1	1	—	0	0	0	0	—	—	2	0	2	0	0	0	0	C	
Channel balance 1, Rch→Lch	CB _{1R-L}	1	1	2	2	—	2	1	1	—	1	1	—	F	F	F	F	—	—	2	0	2	0	0	0	0	C
Channel balance 2, Rch→Lch	CB _{2R-L}	1	1	2	2	—	2	1	1	—	1	1	—	3	3	3	3	—	—	2	0	2	0	0	0	0	C
Bass boost gain, Rch	VB _{MAXR}	1	1	2	1	—	2	1	—	1	1	—	0	0	F	F	—	—	7	F	2	0	0	0	0	C	
Bass boost gain, Lch	VB _{MAXL}	1	1	1	2	—	1	2	—	1	1	—	F	F	0	0	—	—	7	F	2	0	0	0	0	C	
Bass cut gain, Rch	VB _{MINR}	1	1	2	1	—	2	1	—	1	1	—	0	0	F	F	—	—	0	0	2	0	0	0	0	C	
Bass cut gain, Lch	VB _{MINL}	1	1	1	2	—	1	2	—	1	1	—	F	F	0	0	—	—	0	0	2	0	0	0	0	C	
Treble boost gain, Rch	VT _{MAXR}	1	1	2	1	—	2	1	—	1	1	—	0	0	F	F	—	—	2	0	7	F	0	0	0	C	
Treble boost gain, Lch	VT _{MAXL}	1	1	1	2	—	1	2	—	1	1	—	F	F	0	0	—	—	2	0	7	F	0	0	0	C	
Treble cut gain, Rch	VT _{MINR}	1	1	2	1	—	2	1	—	1	1	—	0	0	F	F	—	—	2	0	0	0	0	0	0	C	
Treble cut gain, Lch	VT _{MINL}	1	1	1	2	—	1	2	—	1	1	—	F	F	0	0	—	—	2	0	0	0	0	0	0	C	
AGC input / output level 1, Rch	V _{AGC1R}	1	1	2	2	—	2	1	—	1	1	—	F	F	F	F	—	—	2	0	2	0	0	0	0	1	
AGC input / output level 1, Lch	V _{AGC1L}	1	1	2	2	—	1	2	—	1	1	—	F	F	F	F	—	—	2	0	2	0	0	0	0	1	
AGC input / output level 2, Rch	V _{AGC2R}	1	1	2	2	—	2	1	—	1	1	—	F	F	F	F	—	—	2	0	2	0	0	0	0	1	
AGC input / output level 2, Lch	V _{AGC2L}	1	1	2	2	—	1	2	—	1	1	—	F	F	F	F	—	—	2	0	2	0	0	0	0	1	
AGC input / output level 3, Rch	V _{AGC3R}	1	1	2	2	—	2	1	—	1	1	—	F	F	F	F	—	—	2	0	2	0	0	0	0	1	
AGC input / output level 3, Lch	V _{AGC3L}	1	1	2	2	—	1	2	—	1	1	—	F	F	F	F	—	—	2	0	2	0	0	0	0	1	
AGC input / output level 4, Rch	V _{AGC4R}	1	1	2	2	—	2	1	—	1	1	—	F	F	F	F	—	—	2	0	2	0	0	0	0	1	
AGC input / output level 4, Lch	V _{AGC4L}	1	1	2	2	—	1	2	—	1	1	—	F	F	F	F	—	—	2	0	2	0	0	0	0	1	
Total harmonic distortion at AGC on, Rch	THD _{AGCR}	1	1	2	2	—	2	1	—	1	1	—	F	F	F	F	—	—	2	0	2	0	0	0	0	1	
Total harmonic distortion at AGC on, Lch	THD _{AGCL}	1	1	2	2	—	1	2	—	1	1	—	F	F	F	F	—	—	2	0	2	0	0	0	0	1	

Video ICs

Parameter	Symbol	SW NO.											I ² C BUS												Measurement point		
													Selected address / data														
		1	2	3	4	5	6	7	8	9	10	11	0	0	0	1	0	2	0	3	0	4	0	5		0	6
Max. surround gain, Rch	V _{SUMAXR}	1	1	2	1	—	2	1	—	1	1	—	0	0	F	F	—	—	2	0	2	0	C	F	0	0	ⓑ
Max. surround gain, Lch	V _{SUMAXL}	1	1	1	2	—	1	2	—	1	1	—	F	F	0	0	—	—	2	0	2	0	C	F	0	0	ⓑ
Min. surround gain, Rch	V _{SUMINR}	1	1	2	1	—	2	1	—	1	1	—	0	0	F	F	—	—	2	0	2	0	C	0	0	0	ⓑ
Min. surround gain, Lch	V _{SUMINL}	1	1	1	2	—	1	2	—	1	1	—	F	F	0	0	—	—	2	0	2	0	C	0	0	0	ⓑ
Surround gain at Loop ON, Rch	V _{LPSUR}	1	1	2	1	—	2	1	—	1	1	—	0	0	F	F	—	—	2	0	2	0	D	6	0	0	ⓑ
Surround gain at Loop ON, Lch	V _{LPSUL}	1	1	1	2	—	1	2	—	1	1	—	F	F	0	0	—	—	2	0	2	0	D	6	0	0	ⓑ
Bass Add ON gain, Rch	V _{BAONR}	1	1	2	1	—	2	1	—	1	1	—	0	0	F	F	—	—	2	0	2	0	0	0	1	0	ⓑ
Bass Add ON gain, Lch	V _{BAONL}	1	1	1	2	—	1	2	—	1	1	—	F	F	0	0	—	—	2	0	2	0	0	0	1	0	ⓑ
Pseudo-stereo gain, Rch	V _{MONR}	1	1	2	2	—	2	1	—	1	1	—	F	F	F	F	—	—	2	0	2	0	A	F	0	0	ⓑ
Pseudo-stereo gain, Lch	V _{MONL}	1	1	2	2	—	1	2	—	1	1	—	F	F	F	F	—	—	2	0	2	0	A	F	0	0	ⓑ
DAC pin operating voltage 1	V _{DAC1}	1	1	1	1	—	1	1	—	1	2	1	0	0	0	0	—	—	2	0	2	0	0	0	2	0	ⓓ
DAC pin operating voltage 2	V _{DAC2}	1	1	1	1	—	1	1	—	1	2	2	0	0	0	0	—	—	2	0	2	0	0	0	0	0	ⓓ
SCL and SDA pin input high level	V _{IHI}	1	1	1	1	—	1	1	—	1	1	—	—	—	—	—	—	—	—	—	—	—	—	—	—	—	ⓔ ⓕ
SCL and SDA pin input low level	V _{ILO}	1	1	1	1	—	1	1	—	1	1	—	—	—	—	—	—	—	—	—	—	—	—	—	—	—	ⓔ ⓕ

Video ICs

●Data setting methods

(1) I²C BUS timing

Parameter	Symbol	Min.	Typ.	Max.	Unit
Clock frequency range	f _{SCL}	0	-	100	kHz
The HIGH period of the clock	t _{HIGH}	4	-	-	μs
The LOW period of the clock	t _{LOW}	4.7	-	-	μs
SCL rise time	t _r	-	-	1	μs
SCL fall time	t _f	-	-	0.3	μs
Set-up time for start condition	t _{SU} ; STA	4.7	-	-	μs
Hold time for start condition	t _{HD} ; STA	4	-	-	μs
Set-up time for stop condition	t _{SU} ; STO	4.7	-	-	μs
Time bus must be free before a new transmission can start	t _{BUF}	4.7	-	-	μs
Set-up time data	t _{SU} ; DAT	250	-	-	ns

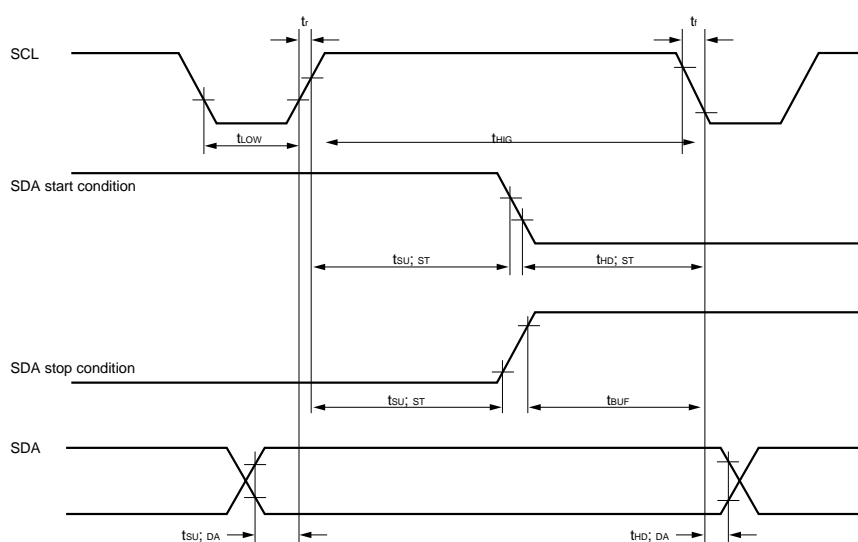

t_{SU} ; STA = start code set -up time.
t_{HD} ; STA = start code hold time.
t_{SU} ; STO = stop code set -up time.

t_{BUF} = bus free time.
t_{SU} ; DAT = data a set-up time.
t_{HD} ; DAT = data a hold time.

Fig.2 Timing requirements for I²C BUS

The above characteristics are logical values in the IC design, and are not guaranteed based on the shipping inspection. Any problems that may arise will be handled through mutual discussion in good faith.

Video ICs

(2) I²C BUS data format

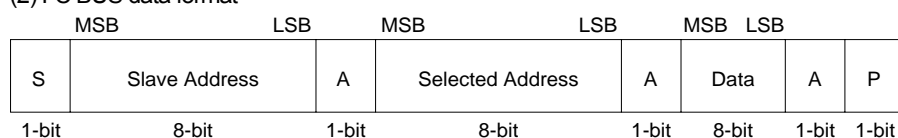

- S = start condition (recognition of start bit)
- Slave address = Recognition of IC. First 7 bit may consist of any data. The last bit must be LOW for writing purposes.
- A = Acknowledge bit (recognition of recognition response)
- Selected address = Selection of volume, bass, treble, or matrix surround.
- Data = Various items of volume and sound quality data.
- P = Stop condition (recognition of stop bit)

(3) Interface protocol

1) Basic format

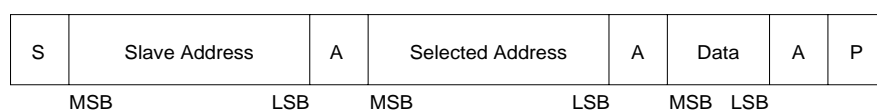

2) Auto increment (the selected address is incremented (+1) by the number of data)



(Example 1) Data 1 is set as the data of the address specified by the "Selected Address" parameter.

(Example 2) Data 2 is set as the data of the address specified by the "Selected Address" parameter + 1.

(Example N) Data N is set as the data of the address specified by the "Selected Address" parameter + N - 1.

3) Configuration which cannot be transmitted (in this case, only selected address 1 is set)

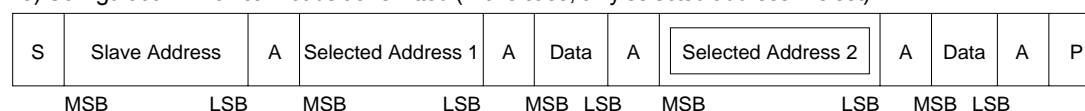

CAUTION : If Selected Address 2 was sent as data following the data parameter, the contents will be recognized as data, and not as Selected Address 2.

(4) BH3865S slave address

MSB							LSB
A6	A5	A4	A3	A2	A1	A0	R / W
1	0	0	0	0	0	1	0

The above slave address has been registered with Philips Corporation.

Video ICs

(5) Selected addresses

Set address		Selected address							
		MSB							LSB
		A7	A6	A5	A4	A3	A2	A1	A0
0	Lch volume	0	0	0	0	0	0	0	0
1	Rch volume	0	0	0	0	0	0	0	1
2	-	0	0	0	0	0	0	1	0
3	Tone (bass)	0	0	0	0	0	0	1	1
4	Tone (treble)	0	0	0	0	0	1	0	0
5	Surround	0	0	0	0	0	1	0	1
6	AGC	0	0	0	0	0	1	1	0

When sending continuous data, the auto increment function moves through the selected addresses in the following sequence.

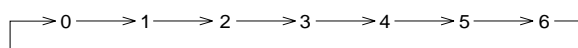

Video ICs

(6) Data

Selected address		MSB		Data				LSB	
Set item		A7	A6	A5	A4	A3	A2	A1	A0
00H	Lch volume	Lch Vol							
01H	Rch volume	Rch Vol							
02H	-	-							
03H	Tone (bass)	*	L / R Bass						
04H	Tone (treble)	SON	L / R Treble						
05H	Surround	*	SSTE	SMON	LOOP	Surround effect			
06H	AGC		*	DAC	BASS	*	*	MUTE	AGC

Selected address	Contents		
00H 01H	Volume : all H : ATT 0dB all L : $-\infty$ (95dB) 1.0dB step level		
03H 04H	Bass / Tre : all H : Max. (FULL BOOST) all L : Min. (FULL CUT)		
05H	Surr effect : (Broad gain adjustment) all H : Max. (15dB) all L : Min. (0dB) 1dB step		
	. LOOP	H : on / L : off	Switch that varies the stage of the phase shift
	. SSTE	H : on / L : off	ON / OFF switch for (L - R) signal (stereo surround)
	. SMON	H : on / L : off	ON / OFF switch for (L + R) signal (pseudo-stereo)
06H	. SON	H : on / L : off	ON / OFF switch for surround effect
	. Mute	H : on / L : off	Muting switch
	. AGC	H : on / L : off	AGC ON / OFF switch
	. BASS	H : mix on / L : mix off	Low-pitch range mixing switch
	. DAC	H : H out / L : L out	0V or 5V output switch

Video ICs

(7) Volume and amount of attenuation (reference examples)

ATT (dB)	DATA (HEX)	ATT (dB)	DATA (HEX)	ATT (dB)	DATA (HEX)
0	FF	-19	4A	-56	16
-1	C4	-20	48	-58	15
-2	AD	-22	43	-60	14
-3	9F	-24	3E	-62	13
-4	93	-26	3A	-63	12
-5	8A	-28	36	-67	10
-6	82	-30	33	-68	0F
-7	7B	-32	30	-70	0E
-8	75	-34	2D	-73	0D
-9	6F	-36	2A	-76	0C
-10	6A	-38	27	-78	0B
-11	66	-40	25	-84	09
-12	61	-42	23	-∞	00
-13	5D	-44	21		
-14	5A	-46	1F		
-15	56	-48	1D		
-16	53	-50	1B		
-17	50	-52	19		
-18	4D	-54	18		

CAUTION : The settings in the above table are reference values. When using them, make sure values are confirmed carefully before being set.

Video ICs

(8) Bass and treble gain settings (reference examples)

Step	I ² C DATA (HEX)	Bass Gain (dB)	Treble Gain (dB)
15	7F	15.9	12.0
14	36	15.2	11.2
13	34	14.3	10.4
12	32	13.0	9.2
11	31	12.2	8.5
10	30	11.3	7.6
9	2F	10.4	6.8
8	2E	9.3	5.8
7	2D	8.0	4.8
6	2C	6.7	3.8
5	2B	5.3	2.9
4	2A	4.0	2.0
3	29	2.9	1.4
2	28	1.8	0.8
1	27	1.1	0.4
0	20	0.0	0.0

Step	I ² C DATA (HEX)	Bass Gain (dB)	Treble Gain (dB)
-1	18	-1.5	-0.8
-2	17	-2.4	-1.3
-3	16	-3.4	-2.0
-4	15	-4.6	-2.8
-5	14	-5.8	-3.7
-6	13	-7.1	-4.7
-7	12	-8.3	-5.7
-8	11	-9.5	-6.6
-9	10	-10.6	-7.5
-10	0F	-11.5	-8.3
-11	0E	-12.3	-9.0
-12	0D	-13.0	-9.6
-13	0B	-14.2	-10.6
-14	09	-15.0	-11.3
-15	00	-15.6	-11.8

Table 5 : Tone microcomputer data (the gain value is given as a guide).

CAUTION

- (1) The gain values given in the table above for treble and bass data are the data when the filter constant is specified such that the peak and bottom values on the frequency characteristic diagram will be at the maximum and minimum gain levels.
- (2) The settings in the above table are reference values. When using them, make sure values are confirmed carefully before being set.

Video ICs

●Application example

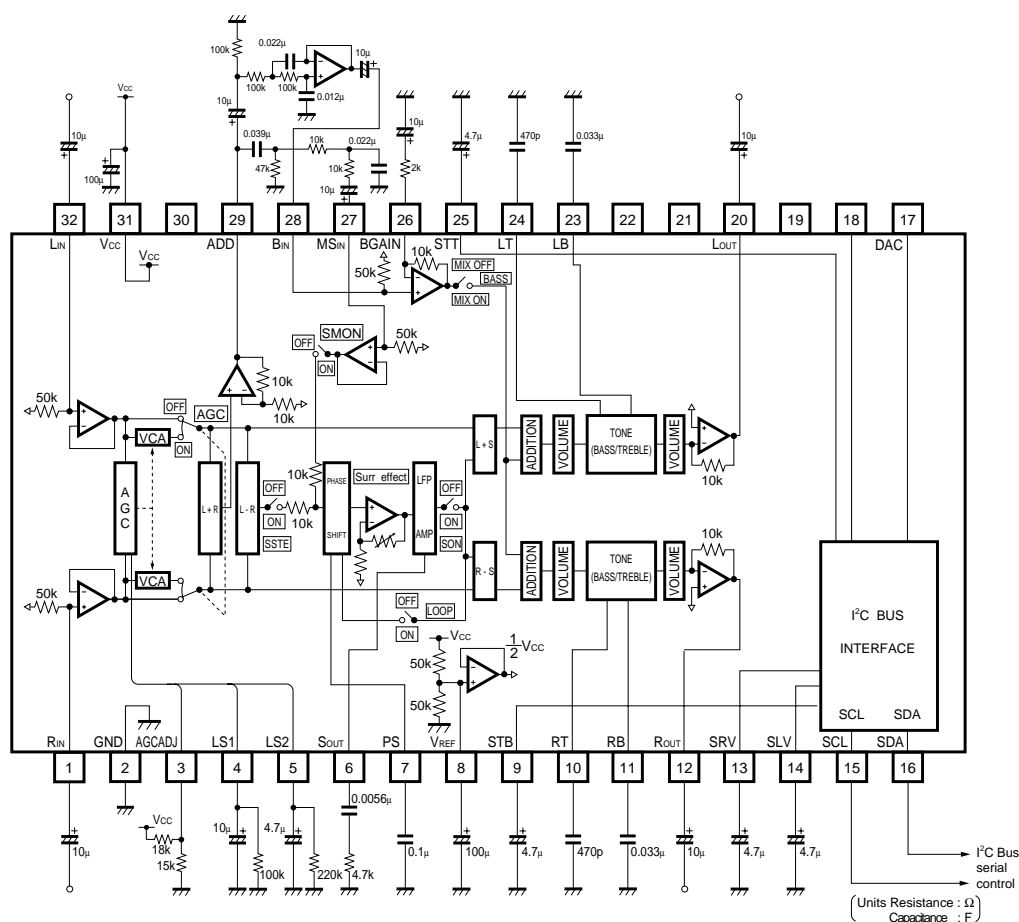

Fig.3

●Operation notes

(1) Operating power supply voltage range

Within the operating power supply voltage range, operation of the basic circuit functions is guaranteed for the ambient operating temperature, but when using the product, be sure that settings for constants and elements, voltage settings, and temperature settings are carefully confirmed.

(2) Operating temperature

Within the recommended operating voltage range, operation of the circuit functions is guaranteed for the operating temperature range. Be aware that power dissipation conditions are related to the temperature. Also, except for conditions determined by electrical characteristics within this range, the rated values for electrical characteristics cannot be guaranteed, but the essential functions are maintained.

(3) Application example

We guarantee the application circuit design, but recommend that you thoroughly check its characteristics in actual use. If you change any of the external component values, check both the static and transient characteristics of the circuit, and allow sufficient margin in your selections to take into account variations in the components and ICs.

Note that Rohm has not fully investigated patent rights regarding this product.

Video ICs

(4) Bass filter for tone control

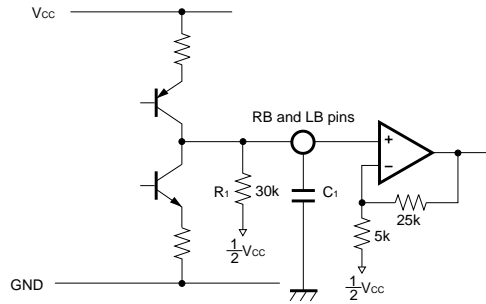

Fig.4

•Determining cutoff frequencies

$$f_{c1} = \frac{1}{2\pi C_1 R_1} = \frac{1}{2\pi C_1 \times 30k}$$

At a frequency of f_{c1} , the LPF will be -3dB.

(5) Treble filter for tone control

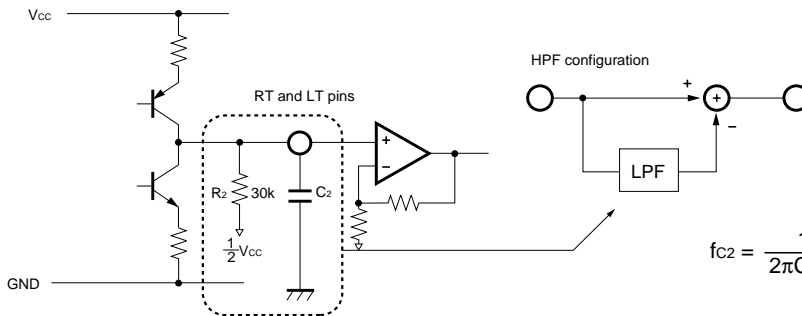

Fig.5

$$f_{c2} = \frac{1}{2\pi C_2 R_2} = \frac{1}{2\pi C_2 \times 30k}$$

(6) Setting the AGC level

The AGC level is set by the voltage divider between voltage V_{cc} and GND. A gain of 0dB voltage should be used in the range of 100mVrms to 400mVrms.

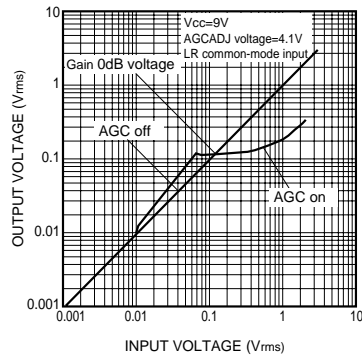

Fig.6 (Reference data) AGC characteristic

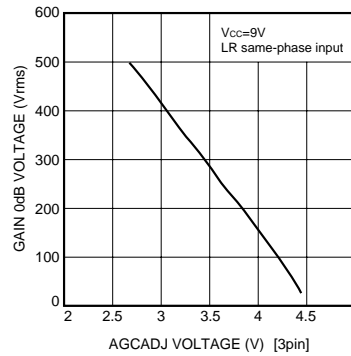

Fig.7 (Reference data) Relation between AGCADJ voltage and gain 0dB voltage

Video ICs

(7) Determining the external LS1 (pin 4) and LS2 (pin 5) for the AGC

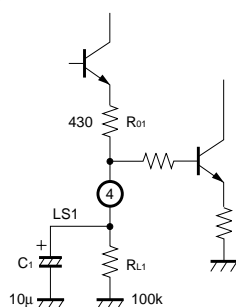

Fig.8 Suppressing phase detecting circuit

- Attack time: $R_{01} \times C_1$
- Recovery time: $R_{L1} \times C_1$

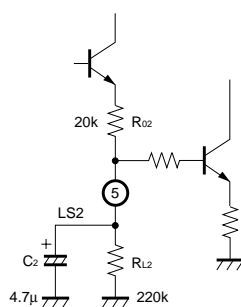

Fig.9 Amplifying phase detection circuit

- Attack time: $R_{02} \times C_2$
- Recovery time: $R_{L2} \times C_2$

The attack and recovery times should be determined based on the internal resistors in the IC and on the external capacitor and resistor. The internal resistors are $R_{01} = 430\Omega$ and $R_{02} = 20k\Omega$ (Typ.).

Reducing the constant of the $C_2 =$ capacitor of LS2 shifts the point where amplification begins in the direction of a lower input voltage. The distortion ratio changes as well, in the direction of worse distortion. Reducing the constant of the C_1 capacitor of LS1 causes worse distortion. Increasing the resistance value of R_{L1} causes the amount of suppression to decrease.

(8) Attachment of external SOUT (pin 6) of surround section L.P.F.

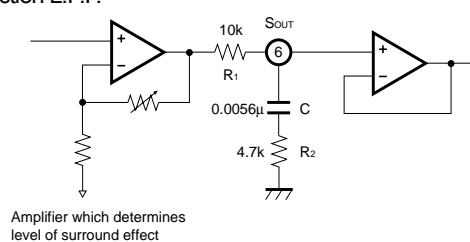

Fig.10

$$f_1 = \frac{1}{2\pi CR_2}$$

$$f_2 = \frac{1}{2\pi C (R_1 + R_2)}$$

$$A_1 = \frac{R_2}{R_1 + R_2}$$

$$A_2 = 1$$

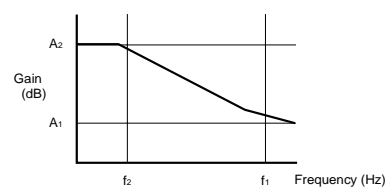

Fig.11

(9) External PS (pin 7) of the phase shifter

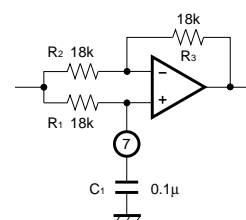

Fig.12

The resistance in the IC is $18k\Omega$ (Typ.).

$$\phi = -2\tan^{-1}(2\pi f R_1 C_1)$$

Video ICs

(10) Surround and pseudo-stereo effects

1) Surround

Δt : Time of delay caused by phase shifter

P : Amount attenuated at phase shifter stage

E : Amount of surround effect

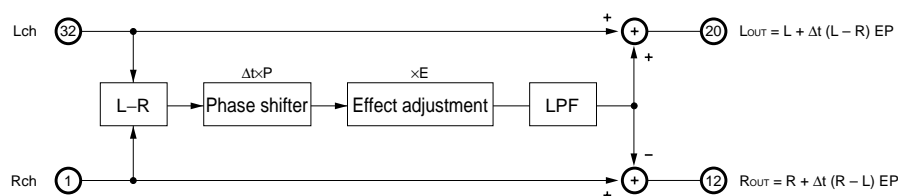

Fig.13

2) Pseudo-stereo effect

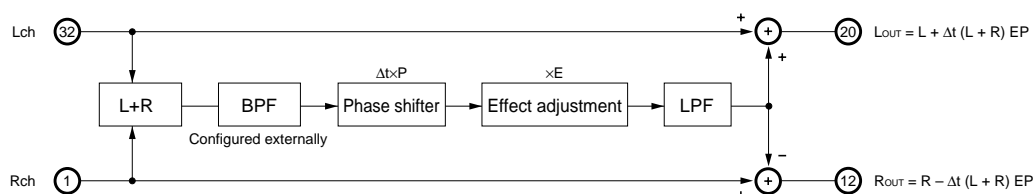

Fig.14

The internal blocks in the IC for the surround and pseudo-stereo effects are configured as shown above. The feeling of the surround location and the stereo feeling of the pseudo-stereo effect can be changed by varying the amount of the effect. Also, the loop switch can be turned on to create a pseudo-increase in the number of phase shifter stages. Raising the gain of the effect level with the loop switch on causes instability, however, so the level of the effects should be kept at around 6dB or below. In order to prevent a popping sound when switching between the surround and pseudo-stereo effects, the switch on the stereo surround side of the SSTE should be left in the ON position.

(11) The level of the surround effect

The level of the surround effect can be varied between 0 and 15dB, using I²C BUS data. Please be aware, however, that this gain is not the total gain between input and output. In precise terms, it specifies the effect level control range of the surround signal for the SOUT pin.

(With single-side input and the stereo / surround effects: $V_{CC} = 9V$, $f = 1kHz$, $V_{IN} = 100mVrms$, $T_a = 25^\circ C$.)

(12) Pin 17 (DAC) output

Setting the DAC command for the I²C BUS to HIGH enables 5V output, and setting it to LOW enables 0V output.

Video ICs

(13) BASS command

Creating an external LPF with the signals (L + R) output from ADD (pin 29) and inputting those signals to BIN (pin 28) enables configuration of a low-pitch amplification circuit. This switch serves as the I²C BUS bass command. The gain for the amplifier can be set through the external resistance, using BGAIN (pin 26).

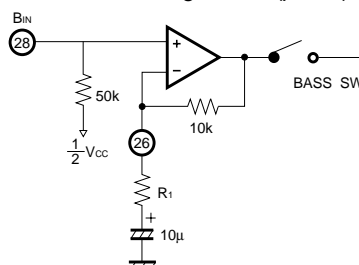

Fig.15

$$\text{GAIN} = 20 \log \frac{10\text{k} + R_1}{R_1}$$

(14) Noise when the step is switched

In the application circuit example, using the SRV, SLV, SCV, STB, and STT pins as an example, constants are provided for each. These constants change depending on the signal level setting, the mounting wiring pattern, and other factors. Careful consideration should be given to the constants before they are determined. An internal equivalent circuit is shown below. (A primary integration circuit is set, so that changes are implemented slowly.)

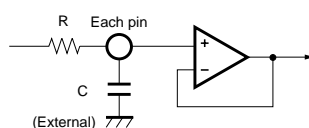

Fig.16

	R value (kΩ)
SRV, SLV, STB, STT	30

(15) Level settings for volume and tone

In this databook, values are noted for the control serial data in relation to the amount of attenuation or gain, as data in relation to the amount of attenuation or gain, as reference values. Since the internal D / A converter is configured on the R-2R system, data exists in locations where there are no continuous changes between one item of data and the next. This can be used where detailed settings are required. However, the volume must be set within eight bits (256 steps), and the tone within seven bits (64 + 1 step).

(16) I²C BUS control

High-frequency digital signals are input to the SCL and SDA pins, so the wiring and wiring patterns must be arranged in such a way that they do not interfere with the analog signal system line.

(17) Power On Reset

When the power supply is turned on, an internal circuit carries out an initialization within the IC. When the power supply is turned on, the volume levels of the left, right, and center channels are set to $-\infty$, and the DAC output (pin 17) is set to 0V. Once it has been turned on, if the power supply is turned off and then immediately turned on again, if there is any residual load on the capacitor, there may be cases when the status described above does not occur. If this happens, operation should be carried out with the muting function on, until an I²C BUS command is transmitted.

Video ICs

(18) Vref (pin 8) capacitor

A capacitance of 100 μ F is recommended for the power supply filter attached to Vref. If this capacitance is set too low, the minimum attenuation level of the volume deteriorates. Crosstalk also tends to deteriorate. The IC contains internal pre-charge and discharge circuits for the capacitor attached to Vref.

(19) Excessive input

Steps have been taken with this product to avoid a situation in which, if a signal is input which exceeds the maximum input voltage for the LIN and RIN pins, a rebound waveform is produced even if hard clipping of the output signal is implemented. Consequently, there is no need to worry that the listener will hear distorted sound because of a rebound waveform.

(20) Relation with the BH3866AS

THE BH3865S and BH3866AS are pin compatible, and share some of the same selected address and data parameters for the I²C BUS. Therefore, the same substrates and software can be shared at the product planning stage.

●Electrical characteristic curves

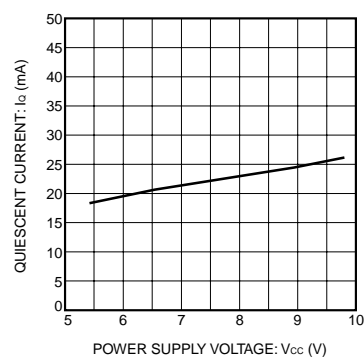

Fig.17 Quiescent current vs. power supply voltage

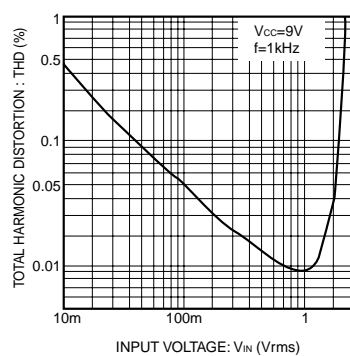

Fig.18 Total harmonic distortion vs. input voltage

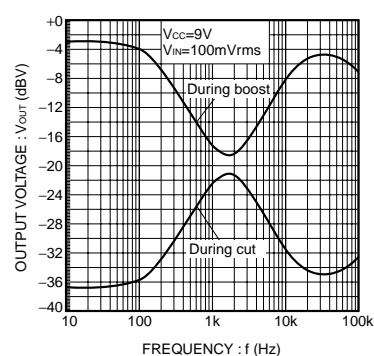

Fig.19 Output gain vs. frequency

●External dimensions (Units : mm)

