

1. GENERAL DESCRIPTION

The BL34018 Speakerphone integrated circuit Incorporates the necessary amplifiers, attenuators, and control functions to produce a high quality hands free speakerphone system. Include are a microphone amplifier, a power audio amplifier for the speaker, transmit and receive attenuators, a monitoring system for background sound level, and an attenuation control system which responds to the relative transmit and receive levels as well as the background level. Also included are all necessary regulated voltages for both internal and external circuitry, allowing line-powered operation (no additional power supplies required). A chip select pin allows the chip to be powered down when not in use. A volume control function may be implemented with an external potentiometer. BL34018 applications include speakerphones for household and business use, intercom systems, automotive telephones, and others.

2. FEATURE

- Voice switched speakerphone circuit.
- All necessary level detection and attenuation controls for a hand-free telephone included.
- Background noise level monitoring with long time constant.
- Background sound level compensation for transmit and receive levels as well as the background level.
- Wide operating dynamic range through signal compression.
- On-chip supply and reference voltage regulation.
- Power audio amplifier for typical 100mW output (into 25 ohms) with peak limiting for speaker to minimize distortion.
- Chip Select pin for active/stand by operation.
- Linear Volume Control Function.

3. BLOCK DIAGRAM

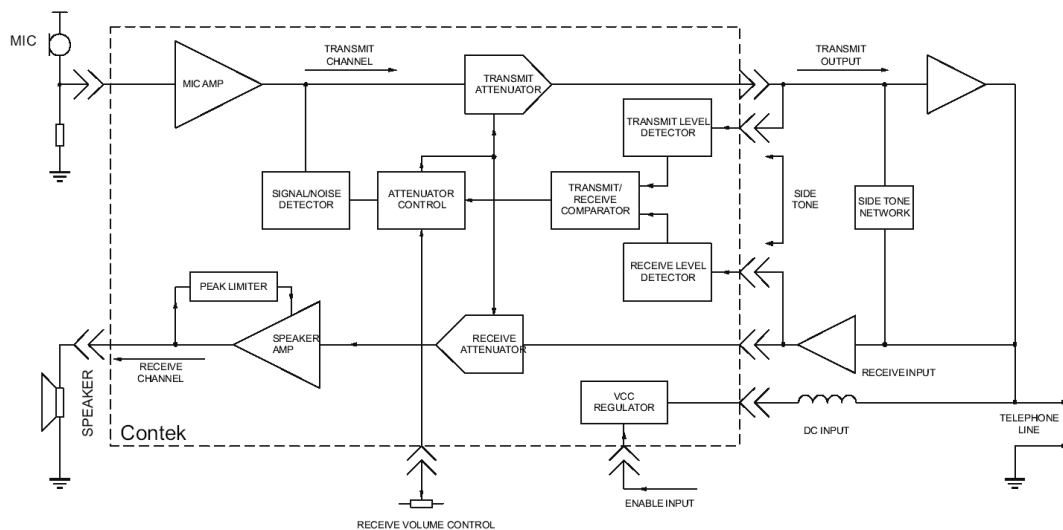

4. PIN CONFIGURATIONS

Pin	Name	Description
1	RR	A resistor to ground provides a reference current for the transmit and receive attenuators.
2	RTX	A resistor to ground determines the nominal gain of the transmit attenuator. The transmit channel gain is inversely proportional to the RTX resistance.
3	TXI	Input to the transmit attenuator. Input resistance is nominally 5.0 k ohms.
4	TXO	Output of the transmit attenuator. The TXO output signal drives the input of the transmit level detector, as well as the external circuit which drives the telephone line.
5	TLI	Input of the transmit level detector. An external resistor ac coupled to the TLI pin sets the detection level. Decreasing this resistor increases the sensitivity to transmit channel signals.
6	TLO	Output of the transmit level detector. The external resistor and capacitor set the time the comparator will hold the system in the transmit mode after speech ceases.
7	RLI	Input of the receive level detector. An external resistor ac coupled to the RLI pin sets the detection level. Decreasing this resistor increases the sensitivity to receive channel signals.
8	RLO	Output of the receive level detector. The external resistor and capacitor set the time the comparator will hold the system in the receive mode after speech ceases.
9	MCI	Microphone amplifier input. Input impedance is nominally 10 k ohms and the dc bias voltage is approximately equal to VB.
10	MCO	Microphone amplifier output. The mic amp gain is internally set at 34 dB (50V/V).
11	CP1	A parallel resistor and capacitor connected between this pin and VCC holds a voltage corresponding to the background noise level. The transmit detector compares the CP1 voltage with the speech signal from CP2.
12	CP2	A capacitor at this pin peak detects the speech signals for comparison with the background noise level held at CP1.
13	XDI	Input to the transmit detector system. The microphone amplifier output is ac coupled to the XDI pin through an external resistor.
14	SKG	High current ground pin for the speaker amp output stage. The SKG voltage should be within 10 mV of the ground voltage at Pin 22.
15	SKO	Speaker amplifier output. The SKO pin will source and sink up to 100 mA when ac coupled to the speaker. The speaker amp gain is internally set at 34 dB (50V/V).
16	V+	Input dc supply voltage. V+ can be powered from Tip and Ring if an ac decoupling inductor is used to prevent loading ac line signals. The required V+ voltage is 6.0 to 11 V (7.5 V nominal) at 7.0 mA.
17	AGC	A capacitor from this pin to VB stabilizes the speaker amp gain control loop and

		additionally controls the attack and decay time of this circuit. The gain control loop limits the speaker amp input to prevent clipping at SKO. The internal resistance at the AGC pin is nominally 110 k ohms.
18	\overline{CS}	Digital chip select input. When at a logic “0” (<0.7 V) the VCC regulator is enabled. When at a logic “1” (>1.6 V), the chip is in the standby mode drawing 0.5 mA. An open \overline{CS} pin is a logic “0”. Input impedance is nominally 140 k ohms. The input voltage should not exceed 11 V.
19	SKI	Input to the speaker amplifier. Input impedance is normally 20 k ohms.
20	VCC	A 5.4 V regulated output which powers all circuits except the speaker amplifier output stage. VCC can be used to power external circuitry such as a microprocessor(3.0 mA max). A filter capacitor is required. The BL34018 can be powered by a separate regulated supply by connecting V+ and VCC to a voltage between 4.5 V and 6.5 V while maintaining \overline{CS} at a logic “1”.
21	VB	An output voltage equal to approximately VCC/2 which serves as an analog ground for the speakerphone system. Up to 1.5 mA of external load current may be sourced from VB. Output impedance is 250 ohms. A filter capacitor is required.
22	Gnd	Ground pin for the IC (except the speaker amplifier).
23	XDC	Transmit detector output. A resistor and capacitor at this pin hold the system in the transmit mode during pauses between words and phrases. When the XDC pin voltage decays to ground the attenuators switch from the transmit mode to the idle mode. The internal resistor at XDC is nominally 2.6 k ohms.
24	VLC	Volume control input. Connecting this pin to the slider of a variable resistor provides receive mode volume control. The VLC pin voltage should be less than or equal to VB.
25	ACF	Attenuator control filter. A capacitor connected to this pin reduces noise transients as the attenuator control switches levels of attenuation.
26	R XO	Output of the receive attenuator. Normally this pin is ac coupled to the input of the speaker amplifier.
27	R XI	Input of the receive attenuator. Input impedance is nominally 5.0 k ohms.
28	R RX	A resistor to ground determines the nominal gain of the receive attenuator. The receive channel gain is directly proportional to the R RX resistance.

5. ELECTRICAL CHARACTERISTICS (Refer to Figure 1)
ABSOLUTE MAXIMUM RATINGS

(voltages referred to Pin 22) (TA = 25°C)

Parameter	Value	Units
V+ Terminal Voltage (Pin 16)	+12, -1.0	V
\overline{CS} (Pin 18)	+12, -1.0	V
Speaker Amp Ground (Pin 14)	+3.0, -1.0	V
VLC (Pin 24)	VCC, -1.0	V
Storage Temperature	-65 to +150	°C

“Maximum Ratings” are those values beyond which the safety of the device cannot be guaranteed. They are not meant to imply that the devices should be operated at these limits. The “Electrical Characteristics” tables provide conditions for actual device operation.

RECOMMENDED OPERATING CONDITIONS

Parameter	Value	Units
V+ Terminal Voltage (Pin 16)	+6.0 to +11	V
\overline{CS} (Pin 18)	0 to +11	V
ICC (Pin 20)	0 to 3.0	mA
VLC (Pin 24)	0.55VB to VB	V
Receive Signal (Pin 27)	0 to 250	mVrms
Microphone Signal (Pin 9)	0 to 5.0	mVrms
Speaker Amp Ground (Pin 14)	-10 to +10	mVdc
Ambient Temperature	-20 to +60	°C

ELECTRICAL CHARACTERISTICS

Parameter	Symbol	Pin	Min	Typ	Max	Units
SUPPLY VOLTAGES						
V+ Supply Current	IV+	16				
V+ = 11V, Pin 18 = 0.7V			--	--	9.0	mA
V+ = 11V, Pin 18 = 1.6V			--	--	800	uA
VCC Voltage (V+ = 7.5V)	VCC	20	4.9	5.4	5.9	Vdc
Line Regulation (6.5V < V+ < 11V)	$\Delta VCC LN$		--	65	150	mV

Output Resistance (ICC = 3.0 mA)	ROVCC		--	6.0	20	ohm
Dropout Voltage (V+ = 5.0 V)	VCCSAT		--	80	300	mV
VB Voltage (V+ = 7.5V)	VB	21	2.5	2.9	3.3	Vdc
Output Resistance (IB = 1.7 mA)	ROVB		--	250	--	ohm
ATTENUATORS						
Receive Attenuator Gain (@1.0 kHz)		26,				
RX Mode, Pin 24 = VB;	GRX	27	2.0	6.0	10	dB
Pin 27 = 250 mVrms						
Range (RX to TX Modes)	ΔGRX		40	44	48	dB
Idle Mode, Pin 27 = 250 mVrms	GRXI		-20	-16	-12	dB
RXO Voltage (RX Mode)	VRXO		1.8	2.3	3.2	Vdc
Delta RXO Voltage (Switch from RX to TX Mode)	ΔVRXO		--	--	100	mV
RXO Sink Current (RX Mode)	IRXOL		75	--	--	uA
RXO Source Current (RX Mode)	IRXOH		1.0	--	3.0	mA
RXI Input Impedance	RRXI		3.5	5.0	8.0	kΩ
Volume Control Range (RX Attenuator Gain, RX Mode, 0.6VB < Pin 24 < VB)	VCR		24.5	--	32.5	dB
Transmit Attenuator Gain (@1.0 kHz)	GTX	3,	4.0	6.0	8.0	dB
TX Mode, Pin 3 = 250 mVrms		4				
Range (TX to RX Mode)	ΔGTX		40	44	48	dB
Idle Mode, Pin 3 = 250 mVrms	GTXI		-16.5	-13	-8.5	dB
			1.8			
TXO Voltage (TX Mode)	VTXO		--	2.3	3.2	Vdc
Delta TXO Voltage (Switch from TX to RX Mode)	ΔVTXO			--	100	mV
			75			
TXO Sink Current (TX Mode)	ITXOL		1.0	--	--	uA
TXO Source Current (TX Mode)	ITXOH		3.5	--	3.0	mA
TXI Input Impedance	RTXI			5.0	8.0	kΩ
ACF Voltage (VCC - Pin 25 Voltage)	ΔVACF	20,				
RX Mode		25	--	150	--	mV
Tx Mode			--	6.0	--	mV
Idle Mode			--	75	--	mV
SPEAKER AMPLIFIER						
Speaker Amp Gain (Pin19 = 20mVrms)	GSPK	15,	33	34	35	dB
		9				
SKI Input Impedance	RSKI		15	22	37	kΩ
SKO Voltage (Pin 19 = Cap Coupled to GND)	VSKO		2.4	3.0	3.6	Vdc
SKO High Voltage (Pin 19 = 0.1V, -100 mA load at Pin 15)	VSKOH		5.5	--	--	Vdc

SKO Low Voltage (Pin 19 = -0.1V, +100 mA load at Pin 15)	VSKOL		--	--	600	mV
MICROPHONE AMPLIFIER						
Mike Amp Gain (Pin 9 = 10mVrms , 1.0 kHz)	GMCI	9, 10	32.5	34	35	dB
Mike Amp Input Resistance	RMCI		6.5	10	16	kΩ
LOGAMPS						
RLO Leakage Current (Pin 8 = VB + 1.0V)	ILKRLO	8	--	--	2.0	uA
TLO Leakage Current (Pin 6 = VB + 1.0V)	ILKTLO	6	--	--	2.0	uA
Transmit -Receive Switching Threshold (Ratio of ITLI to IRLI - at 20 uA - to switch TX-RX Comparator)	ITH	5,7 25	0.8	--	1.2	
TRANSMIT DETECTOR						
XDC Voltage -- Idle Mode	VXDC	23	--	0	--	Vdc
-- TX Mode			--	4.0	--	Vdc
CP2 Current Source	ICP2	12	5.0	10	13	uA
DISTORTION						
RX Mode – RXI to SKO (Pin 27 = 10mVrms ,1.0kHz)	RXD	27, 15	--	1.5	--	%
TX Mode – MCI to TXO (Pin 9 = 5.0mVrms ,1.0kHz)	TXD	4,9	--	2.0	--	%

NOTES: 1. $V_+ = 7.5V$, $\overline{CS} = 0.7V$ except where noted.

2. RX Mode : Pin 7 = -100 uA, Pin 5 = +100 uA, except where noted.

TX Mode : Pin 5,13 = -100 uA, Pin 7 = +100 uA, Pin 11 = 0V.

Idle Mode: Pin 5 = -100 uA, Pin 7, 13 = +100 uA.

3. Current into a pin designated as +; current out of a pin designated as - .

4. Voltages referred to Pin 22. TA = +25°C.

TEMPERATURE CHARACTERISTICS (-20 to 60°C)

Parameter	Pin	Typical Change	Units
V+ Supply Current (V+ = 11V, Pin 18 = 0.7V)	16	-0.2	%/°C
V+ Supply Current (V+ = 11V, Pin 18 = 1.6V)	16	-0.4	%/°C
VCC Voltage (V+ = 7.5V)	20	+0.1	%/°C
Attenuator Gain (Max and Min Settings)		±0.003	dB/°c

Delta RXO, TXO Voltages	4,26	±0.24	%/°C
Speaker Amp Gain	15,19	±0.003	dB/°c
Microphone Amp Gain	9,10	±0.001	dB/°c
Microphone Amp Input Resistance	9	+0.4	%/°c
Tx - Rx Switching Threshold (@ 20 uA)	5,7	±0.2	nA/°c

6. DESIGN GUIDELINES(REF TO FIG. 1)

ATTENUATORS

The transmit and receive attenuators are complementary in function, i.e., when one is at maximum gain the other is at maximum attenuation, and vice versa. They are never both on or both off. Their main purpose is to control the transmit and receive paths to provide the half-duplex operation required of a speakerphone. The attenuators are controlled safely by the voltage at the ACF pin. The ACF voltage is provided by the Attenuator Control block, which receives 3 inputs: a) the TX - RX Comparator, b) the Transmit Detector Comparator, and c) the Volume Control. The response of the attenuators is based on the difference of the ACF voltage from VCC (referred to as ΔV_{acf}). If ΔV_{acf} is approximately 6mV the transmit attenuator is fully on and the receive attenuator is fully off (transmit mode). If ΔV_{acf} is approximately 150mV the circuit is in the receive mode. If ΔV_{acf} is approximately 75mV, the circuit is in the idle mode, and the two attenuators are at gain settings approximately half way (in dB) between their fully on and fully off positions.

The maximum gain and attenuation values are determined by the three external resistors RR, RTX, and RRX. RR affects both attenuators according to its value RELATIVE to RTX and RRX. RTX affects the gain and attenuation of only the transmit attenuator, while RRX affects the gain and attenuation of only the receive attenuator. A value of 30 k is recommended for RR as a starting point, and then RTX and RRX selected to suit the particular design goals.

The input impedance of the attenuators (at TXI and RXI) is typically 5.0 k Ω , and the maximum input signal which will not cause output distortion is 250 mVrms(707 mVP-P). The 4300 ohm resistor and 0.01 uF capacitor at RXO (in Figure 1) filters out high frequency components in the receive path. This helps minimize high frequency acoustic feedback problems. The filter's insertion loss is 1.5 dB at 1.0 kHz. The outputs of the attenuators are inverted from their inputs.

Referring to the attenuator control block, the ΔV_{acf} voltage at its output is determined by three inputs. The relationship of the inputs and output is summarized in the following truth table:

Tx - Rx Comp	Transmit Det Comp	Volume Control	ΔV_{acf}	Mode
Transmit	Transmit	No Effect	6.0 mV	Transmit
Transmit	Idle	No Effect	75 mV	Idle
Receive	Transmit	Affects ΔV_{acf}	50 - 150 mV	Receive
Receive	Idle	Affects ΔV_{acf}	50 - 150 mV	Receive

As can be seen from the truth table, the Tx-Rx comparator dominates. The Transmit Detector Comparator is effective only in the transmit mode, and the Volume Control is effective only in the receive mode.

The Tx-Rx comparator is in the transmit position when there is sufficient transmit signal present over and above any receive signal. The Transmit Detector Comparator then determines whether the transmit signal is a result of background noise (a relatively stable signal) or speech which consists of bursts. If the signal is due to background noise, the attenuators will be put into the idle mode ($\Delta V_{acf} = 75 \text{ mV}$). If the signal consists of speech, the attenuators will be switched to the transmit mode ($\Delta V_{acf} = 6.0 \text{ mV}$.) A further explanation of this function will be found in the section on the transmit detector circuit.

The Tx-Rx comparator is in the receive position when there is sufficient receive signal to overcome the background noise AND any speech signals. The ΔV_{acf} will now be 150 mV IF the volume control is at the maximum position, i.e. VLC (Pin 24) = VB. If VLC is less than VB, the gain of the receive attenuator, and the attenuation of the transmit attenuator, will vary in a complementary manner. At the minimum recommended operating level (VLC = 0.55VB) the gain of the transmit attenuator is actually greater than that of the receive attenuator, although it is at receive mode. The effect of varying VLC is to vary ΔV_{acf} , with a resulting variation in the gains of the attenuators.

The capacitor at ACF (Pin 25) smooths the transition between operating modes. This keeps down any “clicks” in the speaker or transmit signal when the ACF voltage switches.

The gain separation of the two attenuators can be reduced from the typical 45 dB by adding a resistor between Pins 20(VCC) and 25(ACF). The effect is a reduction of the maximum ΔV_{acf} voltage in the receive mode, while not affecting ΔV_{acf} in the transmit mode.

LOGAMPS

(Transmit and Receive Level Detectors)

The log amps monitor the levels of the transmit and receive signals, so as to tell the Tx-Rx comparator which mode should be in effect. The input signals are applied to the amplifiers (at TLI and RLI) through AC coupling capacitors and current limiting resistors. The value of these components determines the sensitivity of the respective amplifiers, and has an effect on the switching times between transmit and receive modes. The feedback elements for the amplifiers are back-to-back diodes which provide a logarithmic gain curve. The outputs of the amplifiers are rectified, having a quick rise and a slow decay time. The rise time is determined primarily by the external capacitor and an internal 500 ohm resistor, and is on the order of a fraction of 1 ms. The decay time is determined by the external resistor and capacitor, and is on the order of a fraction of 1 s. The switching time is not fixed, but depends on the relative values of the transmit and receive signals, as well as these external components.

The Tx-Rx comparator responds to the voltages at TLO and RLO, which in turn are functions of the currents sourced out of TLI and RLI, respectively. If an offset at the comparator input is desired, e.g., to prevent noise from switching the system, or to give preference to either the transmit or receive channel, this may be achieved by biasing the appropriate input (TLI or RLI). A resistor to ground will cause a DC current to flow out of that input, thus forcing the output of that

amplifier to be biased slightly higher than normal. This amplifier then becomes the preferred one in the system operation. Resistor values from 500 k to 10 M ohms are recommended for this purpose.

SPEAKER AMPLIFIER

The speaker amplifier has a fixed gain of 34 dB (50V/V), and is noninverting. The input impedance is nominally 22 k Ω as long as the output signal is below that required to activate the Peak Limiter. Since the output current capability is 100 mA, the output swing is limited to 5.0VPP while load is 25 ohms. The output impedance depends on the output signal level and is relatively low as long as the signal level is not near the maximum limits. At 3 VPP, it is < 0.5 ohms, and at 4.5 VPP, it is < 3 ohms. The output is short circuit protected at approximately 300 mA.

When the amplifier is overdriven, the peak limiter causes a portion of the input signal to be shunted to ground, in order to maintain a constant output level. The effect is that of a gain reduction caused by a reduction of the input impedance (at SKI) to a value not less than 2.0 k Ω .

The capacitor at Pin 17 (AGC) determines the response time of the peak limiter circuit. When a large input signal is applied to SKI, the voltage at AGC will drop quickly as a current source is applied to the external capacitor. When the large input signal is reduced, the current source is turned off, and an internal 110 k Ω resistor discharges the capacitor so the voltage at AGC can return to its normal value (1.9 Vdc). The capacitor additionally stabilizes the peak limiting feedback loop.

If there is a need to mute the speaker amplifier without disabling the rest of the circuit, this may be accomplished by connecting a resistor from the AGC pin to ground. A 100 k Ω resistor will reduce the gain by 34 dB (0 dB from SKI to SKO), and a 10 k Ω resistor will reduce the gain by almost 50 dB.

TRANSMIT DETECTOR CIRCUIT

The transmit detector circuit, also known as the background noise monitor, distinguishes speech (which consists of bursts) from the background noise (a relatively constant signal). It does this by storing a voltage level, representative of the average background noise, in the capacitor at CP1(Pin 11). The resistor and capacitor at this pin have a time constant of approximately 5 seconds(in Figure 1). The voltage at Pin 11 is applied to the inverting input of the Transmit Detector Comparator. In the absence of speech signals, the noninverting input receives the same voltage level minus an offset of 36 mV. In this condition, the output of the comparator will be low, the output transistor turned off, and the voltage at XDC (Pin 23) will be at ground. If the Tx-Rx comparator is in the transmit position, the attenuators will be in the idle mode ($\Delta V_{acf} = 75$ mV). When speech is presented to the microphone, the signal burst appearing at XDI reaches the noninverting input of the transmit detector comparator before the voltage at the inverting input can change, causing the output to switch high, driving the voltage at XDC up to approximately 4 V. This high level causes the attenuator control block to switch the attenuators from the idle mode to the transmit mode (assuming the Tx-Rx comparator is in the transmit mode).

The series resistor and capacitor at XDI (Pin 13) determine the sensitivity of the transmit detector circuit. Increasing the resistor, or lowering the capacitor, will reduce the response at CP2 and CP1.

The response at CP2, CP1, XDC to a varying signal at the microphone is as follows:

1. CP2 (Pin 12) follows the peaks of the speech signals, and decays at a rate determined by the 10 uA current source and the capacitor at CP2.
2. CP1 (Pin 11) increases at a rate determined by the RC at this pin after CP2 has made a positive transition. It will follow the decay pattern of CP2.
3. The noninverting input of the Transmit Detector Comparator follows CP2, gained up by 2.7, and reduced by an offset 36 mV. This voltage, compared to CP1, determines the output of the comparator.
4. XDC (Pin 23) will rise quickly to 4 Vdc in response to a positive transition at CP2, but will decay at a rate determined by the RC at this pin. When XDC is above 3.25 Vdc, the circuit will be in the transmit mode. As it decays towards ground, the attenuators are taken to idle mode.

MICROPHONE AMPLIFIER

The microphone amplifier is noninverting, has an internal gain of 34 dB(50 V/V), and a nominal input impedance of 10 k Ω . The output impedance is typically < 15 ohms. The maximum p-p voltage swing available at the output is approximately 2.0 V less than VCC, which is substantially more than what is required in most applications. The input at MCI(Pin 9) should be ac coupled to the microphone so as to not upset the bias voltage. Generally, microphone sensitivity may be adjusted by varying the 2 k microphone bias resistor, rather than by attempting to varying the gain of the amplifier.

POWER SUPPLY

The voltage supply at V+ (Pin 16) should be in the range of 6.0 to 11 V, although the circuit will operate down to 4.0 V. The voltage can be supplied either from Tip and Ring, or from a separate supply.

It is imperative that the V+ supply be a good ac ground for stability reasons. If it is not well filtered (by a 1000 uF capacitor AT THE IC), any variation at V+ caused by the required speaker current flowing through this pin can cause a low frequency oscillation. The result is usually that the circuit will cut the speaker signal on and off at the rate of a few hertz.

VCC

VCC (Pin 22) is a regulated output voltage of 5.4 \pm 0.5 V. Regulation will be maintained as long as V+ is (typically) 80 mV greater than the regulated value of VCC. Up to 3 mA can be sourced from this supply for external use. The output impedance is < 20 ohms. The 47 uF capacitor connecting to this pin is essential for stability reasons. The capacitor must be located adjacent to the IC. If the circuit is deselected, the VCC will go to 0 V.

VB

VB is a regulated output voltage with a nominal value of 2.9 \pm 0.4 V. It is derived from VCC and tracks it, holding a value of approximately 54% of VCC. 1.5 mA can be sourced from this supply at a typically output impedance of 250 ohms. The 47 uF capacitor connecting to this pin is essential for stability reasons. The capacitor must be located adjacent to the IC. If the circuit is deselected, the VB will go to 0 V.

CHIP SELECT

The \overline{CS} pin (Pin 18) allows the chip to be powered down anytime its functions are not

required. A logic "1" level in the range of 1.6 V to 11 V deselected the chip. The input resistance at Pin 18 is > 75 kΩ. The VCC and VB regulated voltages go to 0.0 when the chip is deselected. Leaving Pin 18 open is equivalent to a Logic "0" (chip enabled).

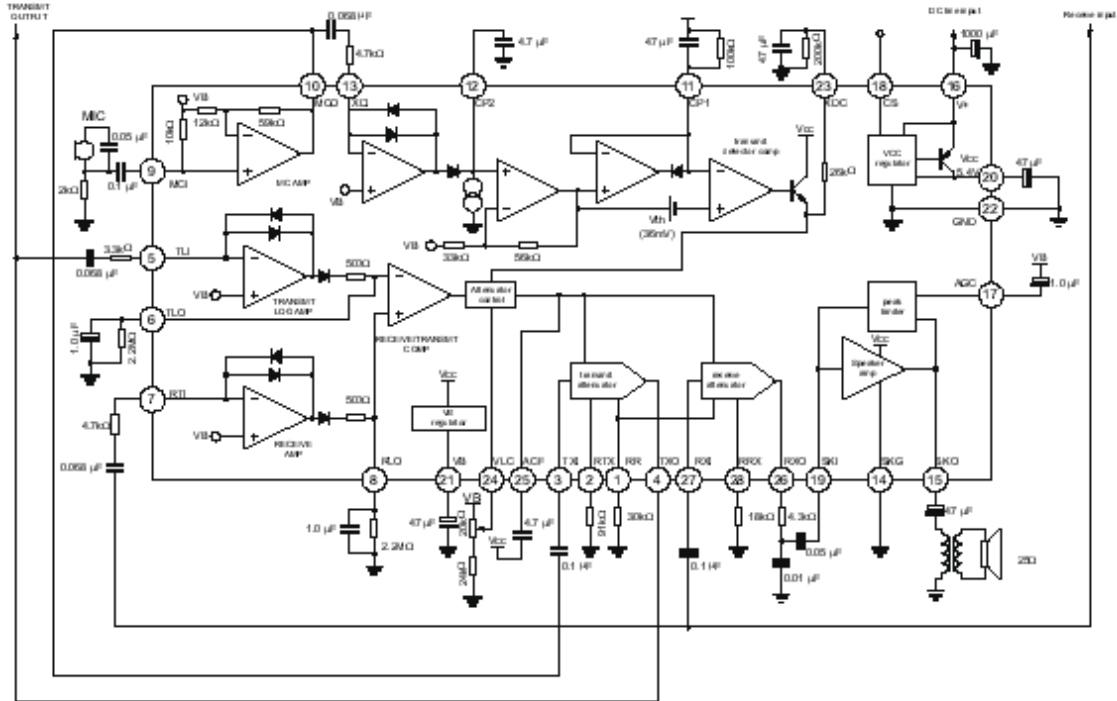

Fig 1 Test circuit

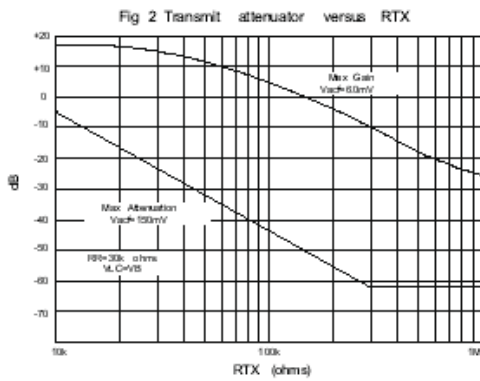

Fig 2 Transmit attenuator versus RTX

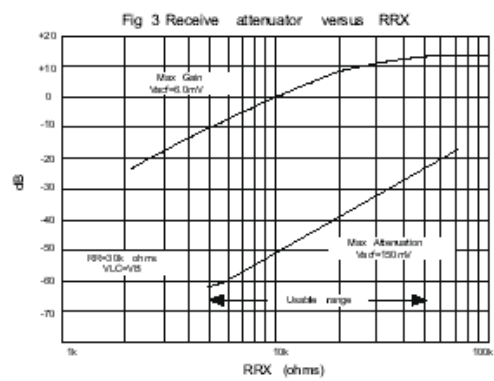

Fig 3 Receive attenuator versus RRX

Fig 4 Gain and attenuation versus Resistor Ratio

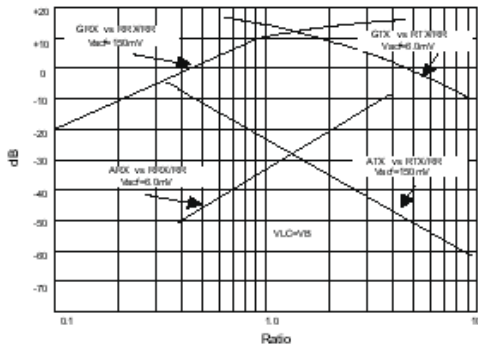

Fig 5 Attenuation Gain versus VLC

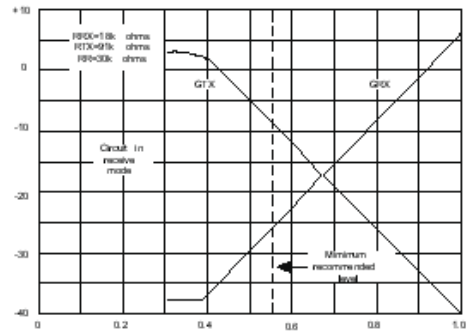

Fig 6 Attenuator Gain vs Vacf

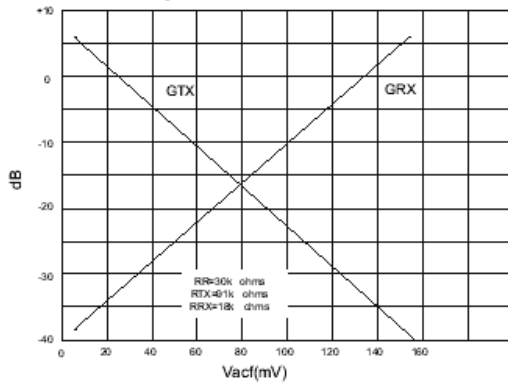

Fig 7 Log Amp Transfer Characteristics

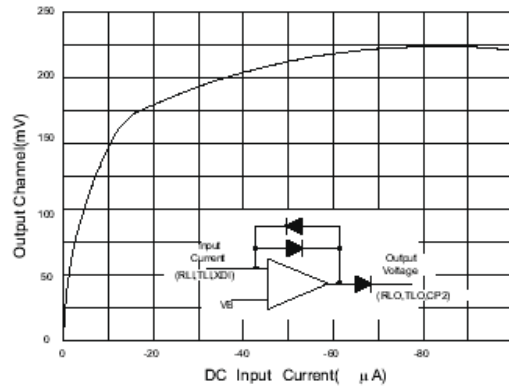

Fig 8 Log Amp Transfer Characteristics

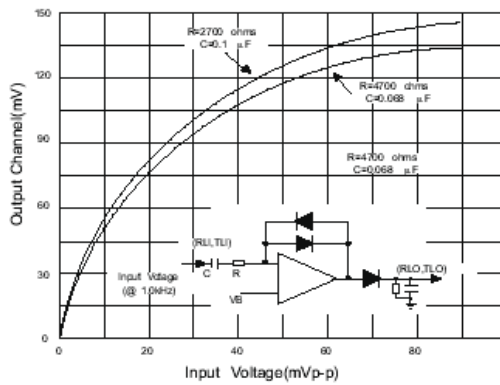
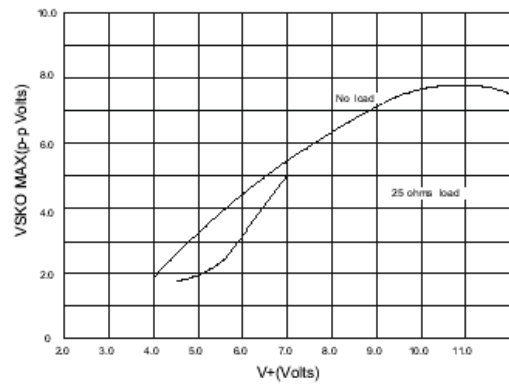

Fig 9 Speaker Amp Output vs Supply Voltage



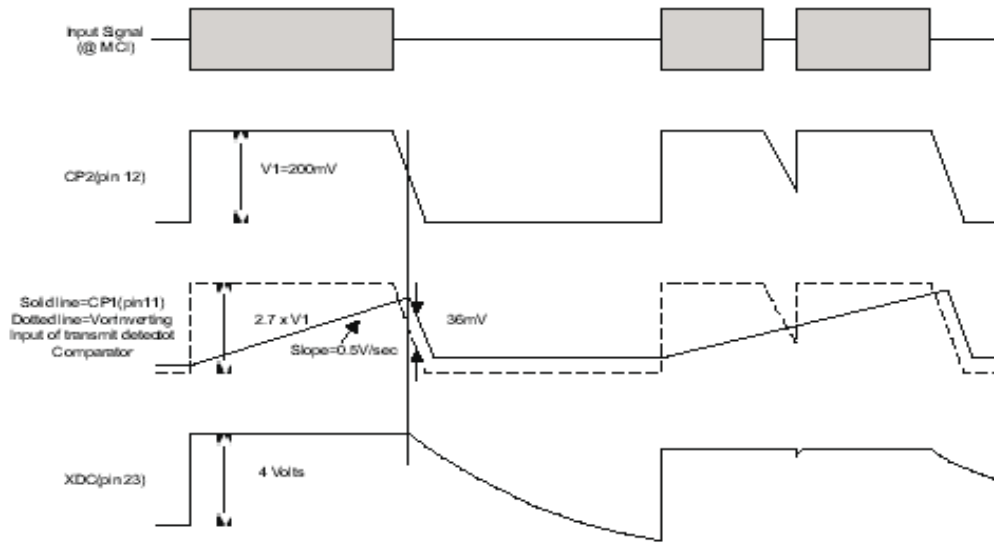

Fig 10 Response At CP1 and CP2

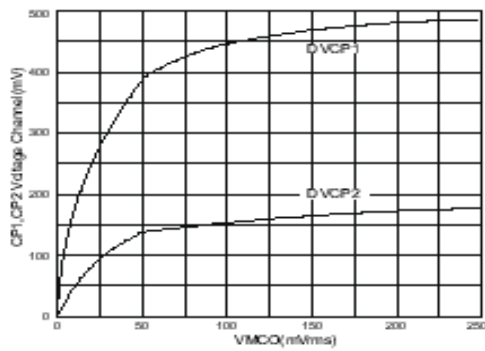

Fig 12 Supply Current vs Supply Voltage

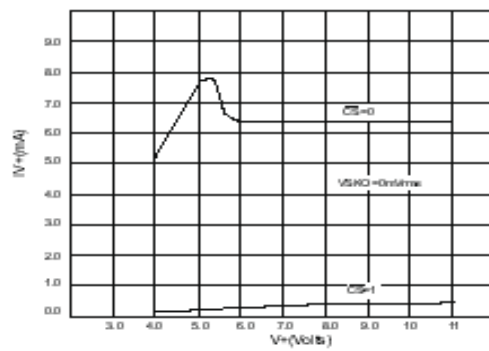

Fig 13 Supply Current vs Supply Voltage vs Speaker Power

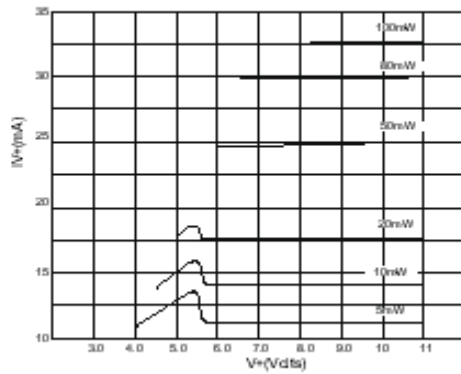

Fig 15 Supply Current vs Supply Voltage

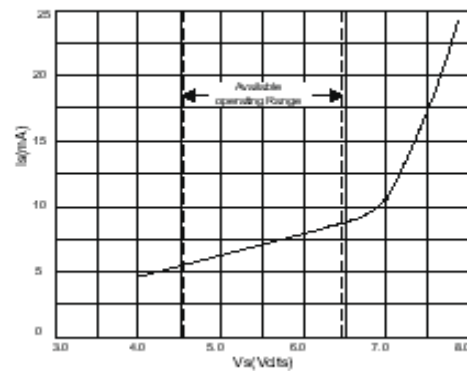
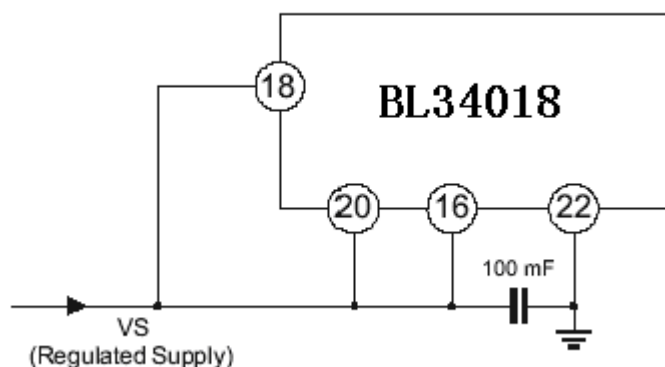

Fig 14 Alternate Power supply Configuration



SWITCHING TIME

The switching times of the speakerphone circuit depends not only on the various external components, but also on the operating conditions of the circuit at the time a change is to take effect. For example, the switching time from idle to transmit is generally quicker than the switching time from receive to transmit (or transmit to receive).

The components which most significantly affect the timing between the transmit and receive modes are those at Pins 5 (transmit turn-on), 6 (transmit turn-off), 7 (receive turn-on), and 8 (receive turn-off). These four timing functions are not independent, but interactive since the Tx-Rx comparator operates on a RELATIVE Tx-Rx comparison, rather than on absolute values. The components at Pins 11, 12, 13 and 23 affect the timing from the transmit mode to the idle mode. Timing from the idle mode to transmit mode is relatively quick (due to the quick charging of the various capacitors), and is not greatly affected by the component values. Pins 5-8 do not affect the idle-to-transmit timing since the Tx-Rx comparator must already be in the transmit mode for this to occur.

The following table provides a summary of the effect on the switching time of the various components, including the volume control:

Components	Tx to Rx	Rx to Tx	Tx to Idle
RC @ Pin 5	Moderate	Significant	No Effect
RC @ Pin 6	Significant	Moderate	No Effect
RC @ Pin 7	Significant	Moderate	No Effect
RC @ Pin 8	Moderate	Significant	No Effect
RC @ Pin 11	No Effect	Slight	Moderate
C @ Pin 12	No Effect	Slight	Significant
RC @ Pin 13	No Effect	Slight	Slight
RC @ Pin 23	No Effect	Slight	Significant
V @ Pin 24	No Effect	Moderate	No Effect
C @ Pin 25	Moderate	Moderate	Slight

Additionally, the following should be noted:

- 1) The RCs at Pins 5 and 7 have a dual function in that they affect the sensitivity of the respective log amplifiers, or in other words, how loud the speech must be in order to get control of the speakerphone circuit.
- 2) The RC at Pin 13 also has a dual function in that it determines the sensitivity of the transmit detector circuit.
- 3) The volume control affects the switching speed, and the relative response to transmit signals, in the following manner: When the circuit is in the receive mode, reducing the volume control setting increases the signal at TXO, and consequently the signal to the TLI pin. Therefore a given signal at TXI will switch the circuit into the transmit mode quicker at low volume settings.

APPLICATIONS INFORMATION

The BL34018 speakerphone IC is designed to provide the function additionally required when a speakerphone is added to a standard telephone. The IC provides the necessary relative level detection and comparison of the speech signals provided by the talkers at the speakerphone (near end speaker) and at the distant telephone (far end speaker).

The BL34018 is designed for use with an electret type microphone a 25 ohms speaker, and has an output power capability of 100mW. All external components surrounding this device are passive, however, this IC does require additional circuitry to interface the Tip and Ring telephone lines. Two suggested circuits are shown in the data sheet.

Fig 16 depicts a configuration which does not include a handset, dialer, or ringer. The only controls are S1 (to make the connection to the line), S2 (a "privacy" switch), and the volume control. It is meant to be used in parallel with a normal telephone which has dialing and ringing functions.

Fig 17 depicts a means of providing logic level signal that indicate which mode of operation the BL34018 is in. Comparator A indicates whether the circuit is in receive or transmit mode and comparator B indicates (when in transmit/idle mode) whether the circuit is in the transmit or idle mode. The LM393 dual comparator is chosen because of its low current requirement (<1.0mA), low voltage requirement (as low as 2.0volts), and low cost.

