

1.25 Watt Fully Differential Audio Power Amplifier With Internal Feedback Resistors

1 FEATURES

- Fully differential amplifier
- Improved PSRR at 217Hz(VDD>3.0V) 86dB (typ)
- Power output at 5.0V & 1% THD 1.25W (typ)
- Power output at 3.6V & 1% THD 0.6W (typ)
- Ultra low shutdown current 0.01 μ A (typ)
- Improved pop & click circuitry eliminates noises during turn-on and turn-off transitions
- Thermal overload protection circuitry
- No output coupling capacitors, bootstrap capacitors required
- Unity-gain stable
- External gain configuration capability
- Available in space-saving package: 9-bump micro SMD and 8-pin MSOP8

2 GENERAL DESCRIPTION

The BL6211 is a fully differential audio power amplifier designed for portable communication device applications. It is capable of delivering 1.25 watt of continuous average power to an 8 Ω BTL load with less than 1% distortion (THD+N) from a 5V battery voltage. It operates from 2.2 to 5.5V.

Features like 86dB PSRR at 217Hz, improved RF-rectification immunity, the space-saving 8-pin MSOP8 and 9-bump micro SMD package, the advanced pop & click circuitry, a minimal count of external components and low-power shutdown mode make BL6211 ideal for wireless handsets.

The BL6211 is unity-gain stable, and the gain can be configured by external input resistors and internal feedback resistors.

3 APPLICATIONS

- Wireless handsets
- Portable audio devices
- PDAs, Handheld computers

4 TYPICAL APPLICATION

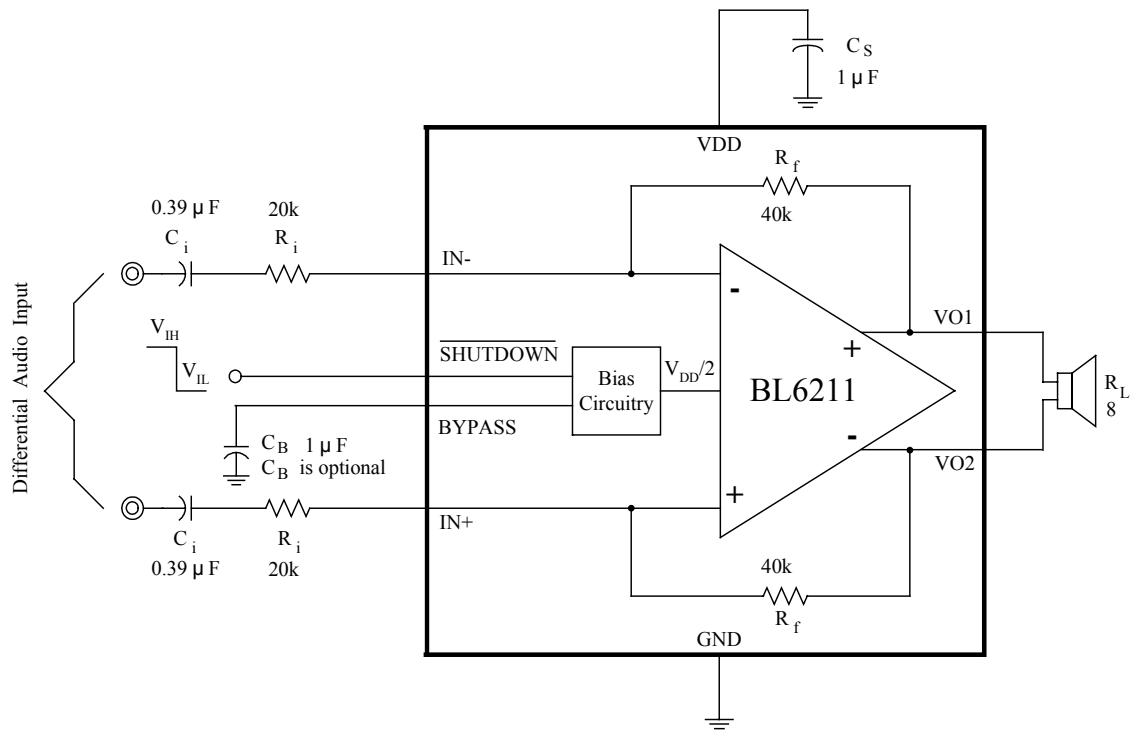

Figure 1 Typical Audio Amplifier Application Circuit

5 ORDER INFORMATION

Table 1. Order information

Part Number	Marking	Package	Shipping
BL6211ITLX	AAG	9 Bump micro SMD	3000 pcs / Tape & Reel
BL6211MM	ABG	8-pin MSOP8	3000 pcs / Tape & Reel

6 PIN DESCRIPTIONS

6.1 Pin Diagram (Top View)

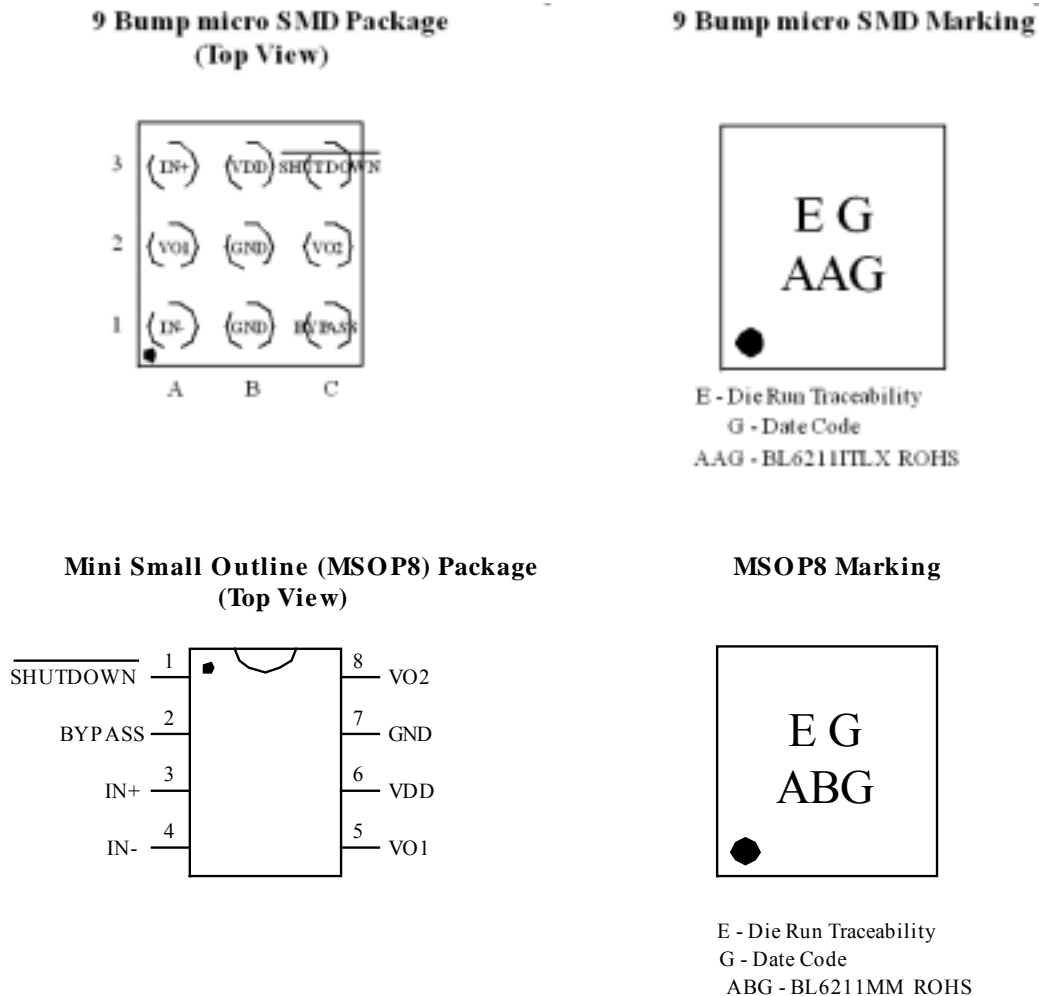

Figure 2 Pin Diagram of BL6211

6.2 Pin Definitions and Functions

Table 2. Pin Definitions and Functions

MSOP8	9-Bump micro SMD	Symbol	Type	Functions
1	C3	SHUTDOWN	I	Shutdown Pin, active low.
2	C1	BYPASS	I	Common mode voltage. Connect a bypass capacitor to GND for common mode voltage filtering. The bypass capacitor is optional.
3	A3	IN+	I	Positive differential input.
4	A1	IN-	I	Negative differential input.

MSOP8	9-Bump micro SMD	Symbol	Type	Functions
5	A2	VO1	O	Positive differential output.
6	B3	VDD	I	Power supply
7	B1,B2	GND	I	Ground.
8	C2	VO2	O	Negative differential output.

7 OPERATION CONDITIONS AND ELECTRICAL CHARACTERISTICS

7.1 Absolute Maximum Ratings (note 1)

Supply voltage, VDD.....	-0.3V to 6.0V
Input voltage.....	-0.3V to VDD +0.3V
Storage Temperature.....	-65 to 150
Power Dissipation (note2).....	Internally Limited
ESD Parameters:	
ESD Protection (HBM, 1.5kΩ and 100pF in series).....	2000V
ESD Protection (MM, 200pF, no resistor)	200V
Junction temperature, T _J	-40 to 150
Thermal Resistance T _{JA} (micro SMD).....	220 /W
Thermal Resistance T _{JC} (MSOP).....	56 /W
Thermal Resistance T _{JA} (MSOP).....	190 /W
Lead Temperature (Soldering, 10 sec).....	300

Note1: stresses beyond those listed under “absolute maximum ratings” may cause permanent damage to the device. These are stress ratings only, and functional operation of the device at these or any other conditions beyond those indicated under “recommended operating conditions” is not implied. Exposure to absolute maximum rated conditions for extended periods may affect device reliability.

Note2: The maximum power dissipation must be derated at elevated temperatures and is dictated by T_{JMAX}, T_{JA}, and the ambient temperature T_A. The maximum allowable power dissipation is P_{DMAX}=(T_{JMAX}-T_A)/ T_{JA} or the number given in Absolute Maximum Ratings, whichever is lower.

7.2 Operation Conditions

Table 3. Operation Conditions

Parameter	Symbol	Min	Typ	Max	Unit
Power Supply Voltage	V _{DD}	2.2		5.5	V
Operating Temperature Range	T _A	-40		85	

7.3 Electrical Characteristics

Table 4. $V_{DD}=5V$ (The following specifications apply for 8 load, $A_V=1V/V$, $T_A=25$, unless otherwise specified.)

Parameter	Symbol	Conditions	Min	Typ	Max	Unit
Quiescent Power Supply Current	I_{DD}	$V_{IN}=0V$, no load		2.5	5	mA
		$V_{IN}=0V$, $R_L=8$		4	8	
Shutdown Current	I_{SD}	$V_{SHUTDOWN}=GND$		0.01	1	μA
Output Power	P_O	THD=1%(max); $f=1kHz$		1.25		W
Total Harmonic Distortion + Noise	THD+N	$P_O=0.6W_{rms}$; $f=1kHz$		0.02		%
Power Supply Rejection Ratio	PSRR	Vripple=200mV sine p-p				dB
		$f=217Hz$ (note1)		-88		
		$f=1kHz$ (note1)		-83		
		$f=217Hz$ (Note2)		-83		
		$F=1KHz$ (Note2)		-83		
Common Mode Rejection Ratio	CMRR	$f=217Hz$ $V_{CM}=200mV_{PP}$		-78		dB
Output Offset	V_{OS}	$V_{IN}=0V$		2	8	mV
Shutdown Voltage Input High	V_{SDIH}		1.5			V
Shutdown Voltage Input Low	V_{SDIL}				0.5	V
Closed Loop Gain	A_V		$\frac{36k}{R_i}$	$\frac{40k}{R_i}$	$\frac{44k}{R_i}$	V/V

Note1: Unterminated input

Note2: 10 terminated input

Table 5. $V_{DD}=3.6V$ (The following specifications apply for 8 Ω load, $A_V=1V/V$, $T_A=25^\circ C$, unless otherwise specified.)

Parameter	Symbol	Conditions	Min	Typ	Max	Unit
Quiescent Power Supply Current	I_{DD}	$V_{IN}=0V$, no load		2	4.5	mA
		$V_{IN}=0V$, $R_L=8\Omega$		3.5	7.5	
Shutdown Current	I_{SD}	$V_{SHUTDOWN}=GND$		0.01	1	μA
Output Power	P_O	THD=1%(max); $f=1kHz$		0.6		W
Total Harmonic Distortion + Noise	THD+N	$P_O=0.4W_{rms}$; $f=1kHz$		0.02		%
Power Supply Rejection Ratio	PSRR	$V_{ripple}=200mV$ sine p-p				dB
		$f=217Hz$ (note1)		-86		
		$f=1kHz$ (note1)		-83		
		$f=217Hz$ (Note2)		-83		
		$F=1KHz$ (Note2)		-83		
Common Mode Rejection Ratio	CMRR	$f=217Hz$ $V_{CM}=200mV_{PP}$		-76		dB
Output Offset	V_{OS}	$V_{IN}=0V$		2	8	mV
Shutdown Voltage Input High	V_{SDIH}		1.5			V
Shutdown Voltage Input Low	V_{SDIL}				0.5	V
Closed Loop Gain	Gain		$\frac{36k}{R_i}$	$\frac{40k}{R_i}$	$\frac{44k}{R_i}$	V/V

Note1: unterminated input

Note2: 10 Ω terminated input

8 TYPICAL CHARACTERISTICS

Output Power vs Supply Voltage
 $R_L=8$

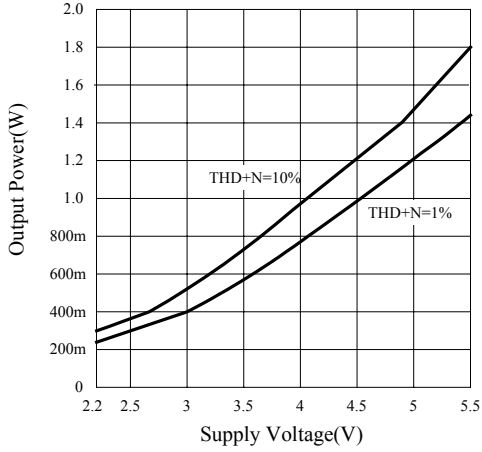

Power Dissipation vs Output Power

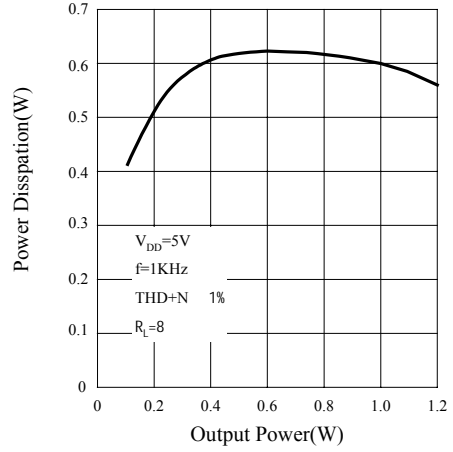

Power Dissipation vs Output Power

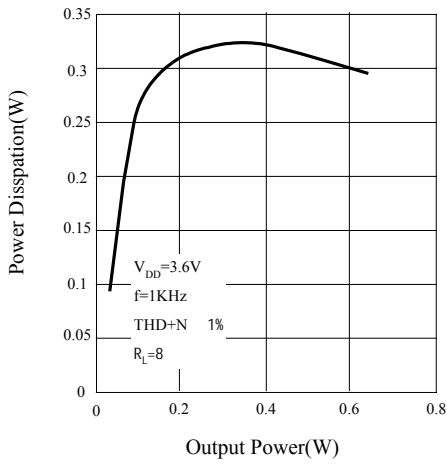

Power Derating Curve

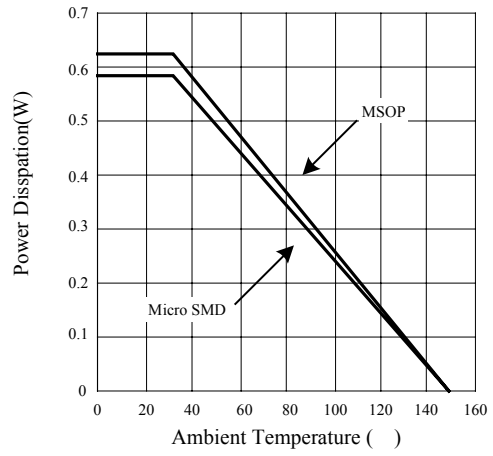

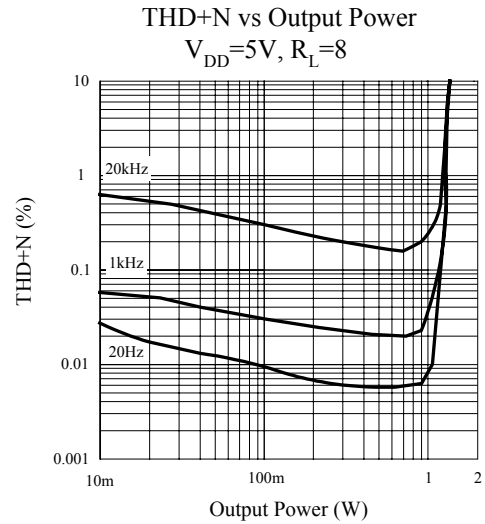
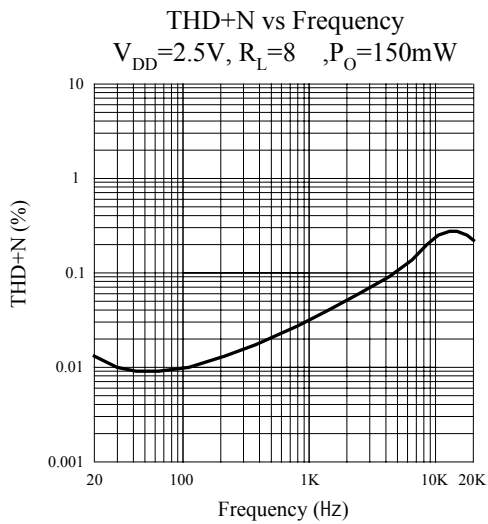
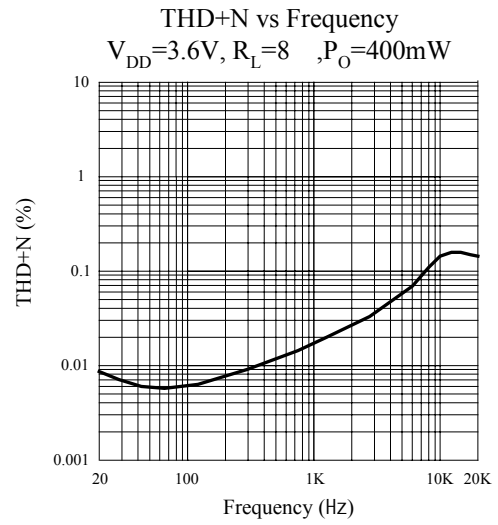
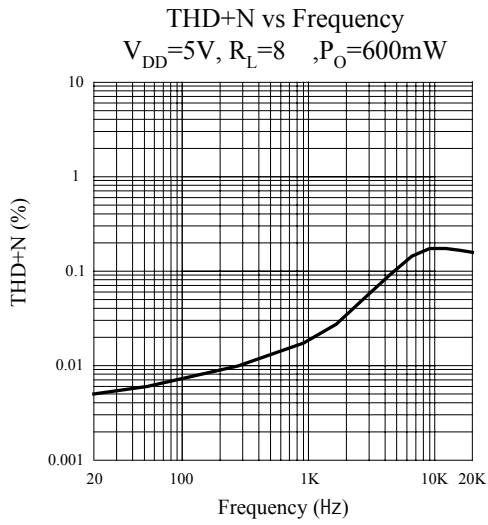

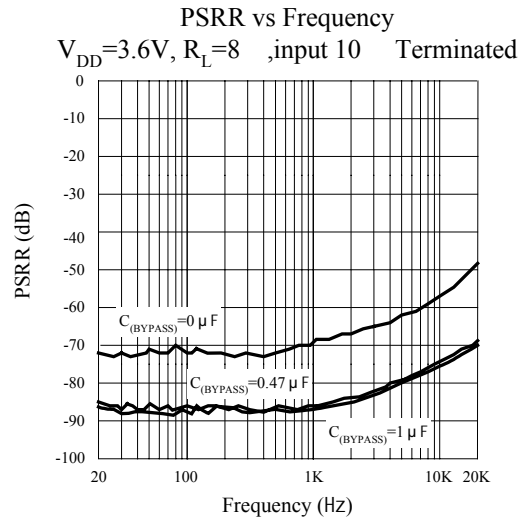
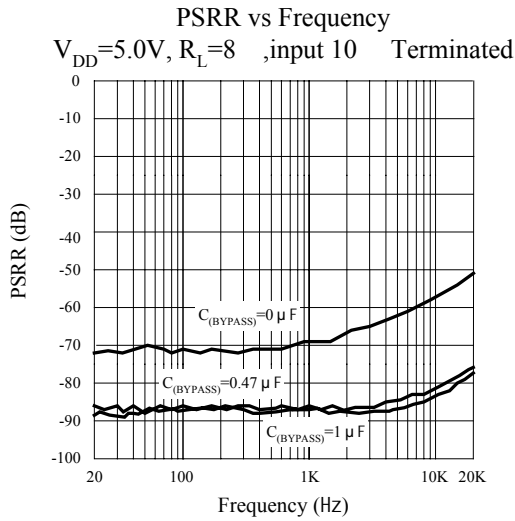
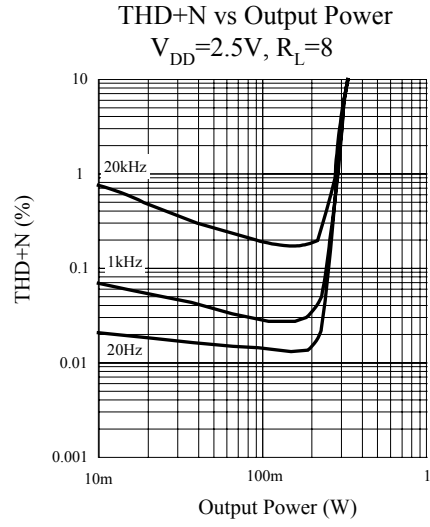
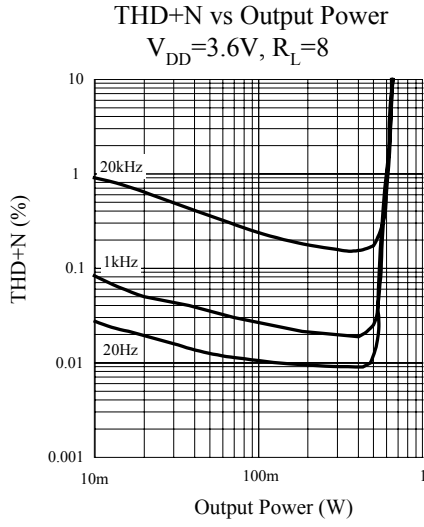

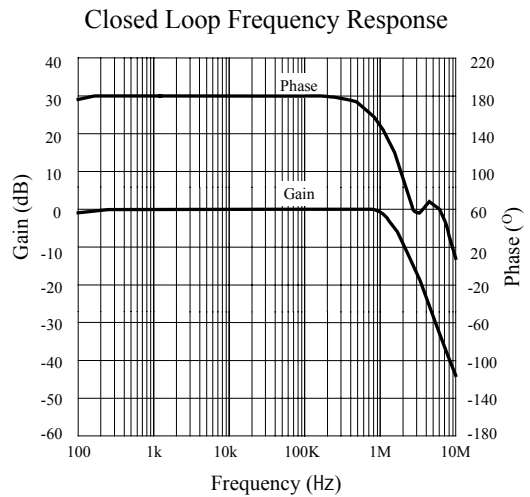
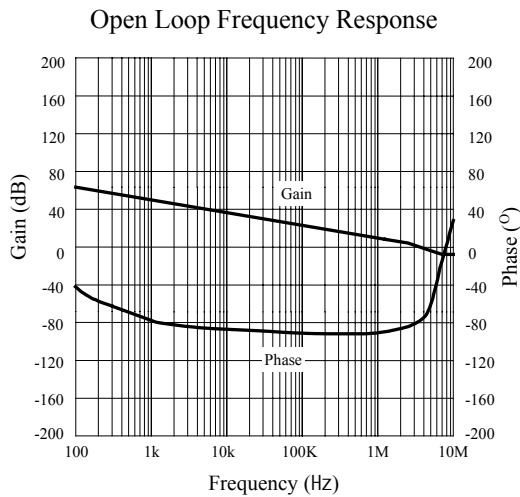
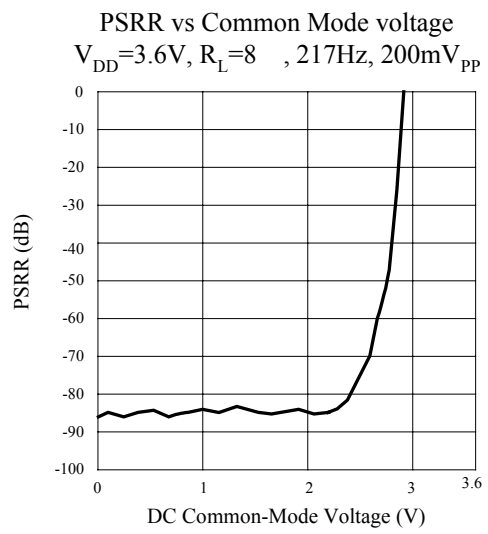
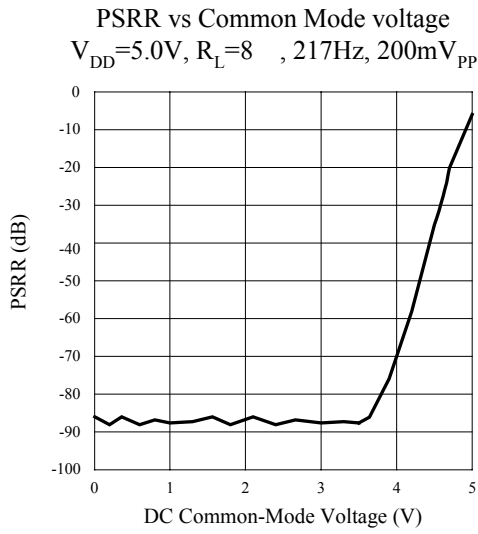

9 APPLICATION INFORMATION

9.1 Fully Differential Amplifier Description

The BL6211 is a fully differential amplifier with differential inputs and outputs. The fully differential amplifier consists of a differential amplifier and a common mode amplifier. The differential amplifier ensures that the amplifier outputs a differential voltage that is equal to the differential input times the gain. The common mode feedback ensures that the common-mode voltage at the output is biased around $V_{DD}/2$ regardless of the common-mode voltage at the input.

The BL6211 provides a "bridged mode" output configuration (bridge-tied-load, BTL). This means the output signals at V_{o1} and V_{o2} that are 180° out of phase with respect to each other. Bridged mode operation is different from the single-ended output configuration that connects the load between the amplifier output and ground. A bridged amplifier design has distinct advantages over the single-ended output configuration: it provides differential drive to the load, thus doubling maximum possible output swing for a specific supply voltage. Four times the output power is possible compared with a single-ended output configuration under the same conditions. This increase in attainable output power assumes that the amplifier is not current limited or clipped.

9.2 Advantages of Fully Differential Amplifier

Input and output coupling capacitor not required: A fully differential amplifier with good CMRR, the BL6211 allows the input signal to be biased at voltage other than mid-supply of the BL6211, the common-mode feedback circuit adjusts for it, and the outputs are still biased at mid-supply of the BL6211.

Mid-supply bypass capacitor, C_{BYPASS} not required: The fully differential amplifier does not require a bypass capacitor. It is because any shift in the mid-supply affects both positive and negative channels equally and cancels the differential output. However, removing the bypass capacitor slightly worsens power supply rejection ration, but a slightly decrease of PSRR may be acceptable when an additional component can be eliminated.

Better RF-immunity: GSM handsets save power by turning on and shutting off the RF transmitter at a rate of 217Hz. The transmitted signal is picked-up on input and output traces. The fully differential amplifier reduces the RF rectification much better than the typical audio amplifier.

9.3 Applications

From Figure 3 to Figure 5 show application schematics for differential and single-ended inputs.

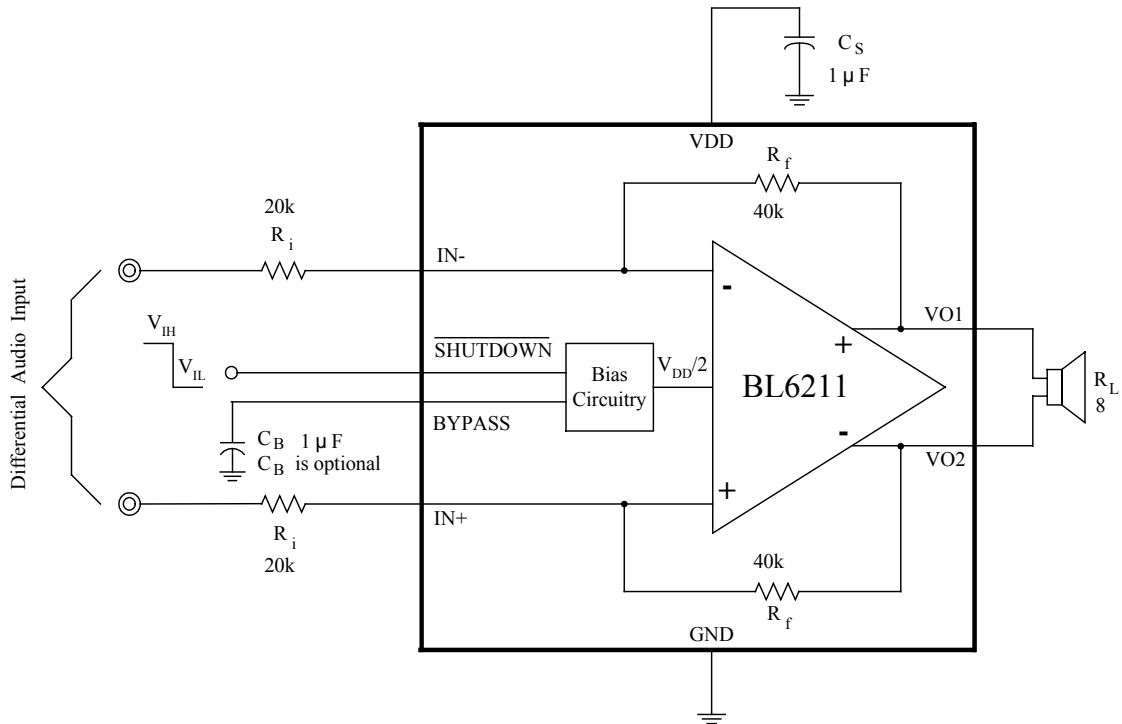

Figure 3 Typical Differential Input Application

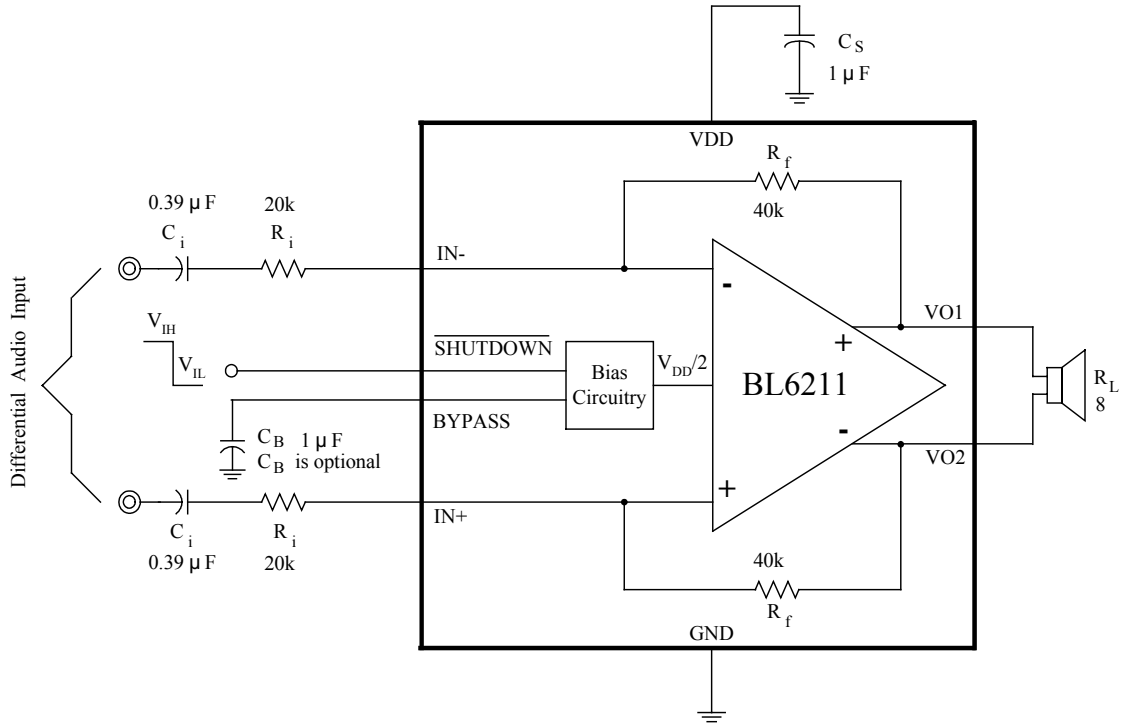

Figure 4 Differential Input Application With Input Capacitors

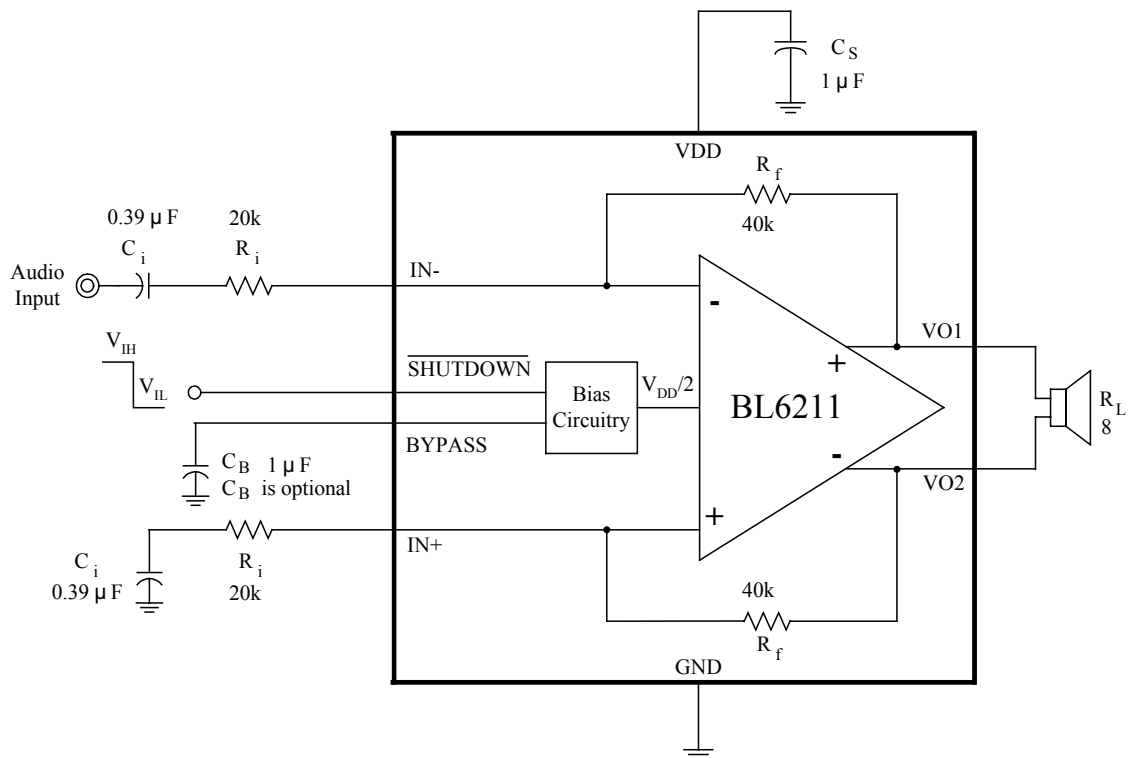

Figure 5 Single-Ended Input Application

9.4 Proper Selection of external Components

9.4.1 Input Resistor (R_i)

The input (R_i) and internal feedback resistors, $R_f=40k$, set the gain of the amplifier according to Equation 1:

$$\text{Gain} = 40k / R_i \quad (1)$$

In order to optimize the THD+N and SNR performance, The BL6211 should be used in low closed-loop gain configuration. R_i should be in range from $1k$ to $100k$. Resistor matching is very important for fully differential amplifiers. The balance of the output on the common mode voltage depends on matched ratios of the resistors. CMRR, PSRR, and the second harmonic distortion is increased if resistor is not matched. Therefore, it is recommended to use 1% tolerance resistors or better to keep the performance optimized.

9.4.2 Input Capacitor (C_i)

The input coupling capacitor blocks the input DC voltage. The BL6211 does not require input coupling capacitors if using a differential input source that is biased from 0.5V to $V_{DD}-0.8V$. Use 1% tolerance or better resistors if not using input coupling capacitors. In the single-ended input application an input capacitor, C_i , is required to allow the amplifier to bias the input signal to the proper dc level.

The C_i and R_i form a high-pass filter with the corner frequency determined in Equation 2.

$$f_c = \frac{1}{2 R_i C_i} \quad (2)$$

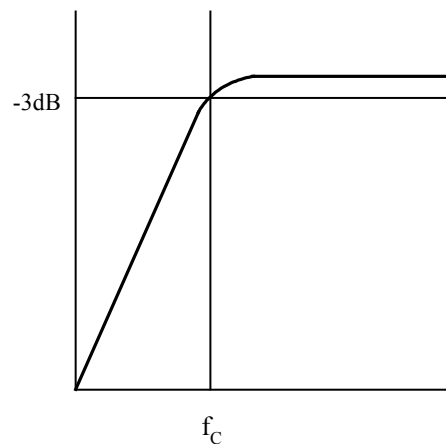

Special care should be taken to the value of C_i because it directly affects the low frequency performance of the system. For example, assuming R_i is $20k$ and the specification calls for a flat response down to $100Hz$. From Equation 2, C_i is $0.08\mu F$, so C_i would likely choose a value in the range of $0.068\mu F$ to $0.47\mu F$. A further consideration for C_i is the leakage path from the input source through the input network (R_i , C_i) and the feedback resistor (R_f) to the load. This leakage current creates a DC offset voltage that reduces useful headroom, especially in high gain applications. For this reason, a ceramic capacitor is the best choice.

9.4.3 Bypass Capacitor (C_{BYPASS}) and Start-Up Time

Connecting a capacitor to BYPASS pin filters any noise into this pin and increases the PSRR performance. C_{BYPASS} also determines the rise time of VO1 and VO2, the larger the capacitor, the slower the rise time, the BL6211 start to work after the C_{BYPASS} voltage reaches the mid-supply voltage. This capacitor can also minimize the pop & click noise during turn-on and turn-off transitions, the larger the capacitor, the smaller the pop & click noise, $1\mu F$ capacitor is recommended for C_{BYPASS} .

9.4.4 Decoupling Capacitor (C_S)

Power supply decoupling is critical for low THD+N and high PSRR performance. A low equivalent-series-resistance (ESR) ceramic capacitor, typically $0.1\mu F$ to $1\mu F$, placed as close as possible to VDD pin make the device works better. For filtering lower frequency noise signals, a $10\mu F$ or greater capacitor placed near the audio power amplifier also helps, but it is not required in most applications because of the high PSRR of this device.

9.5 USING LOW-ESR CAPACITORS

Low-ESR capacitors are recommended. A real capacitor can be modeled simply as a resistor in series with an ideal capacitor. The voltage drop across this resistor minimizes the beneficial effects of the capacitor in the circuit. The lower the equivalent value of this resistance the more the real capacitor behaves like an ideal capacitor.

9.6 POWER DISSIPATION

Power dissipation is a major concern when designing a successful amplifier, whether the amplifier is bridged or single-ended. Equation 3 states the maximum power dissipation point for a single-ended amplifier operating at a given supply voltage and driving a specified output load.

$$P_{D_{MAX}} = \frac{(V_{DD})^2}{(2\pi^2 R_L)} \quad \text{Single-Ended} \quad (3)$$

However, a direct consequence of the increased power delivered to the load by a bridge amplifier is an increase in internal power dissipation versus a single-ended amplifier operating at the same conditions.

$$P_{DMAX} = 4 * \frac{(V_{DD})^2}{(2\pi^2 R_L)} \quad \text{Bridge-Ended} \quad (4)$$

Since the BL6211 has bridged outputs, the maximum internal power dissipation is 4 times that of a single-ended amplifier. Even with this substantial increasing in power dissipation, the BL6211 does not require additional heat-sinking under most operating conditions and output loading. From Equation 4, assuming a 5V power supply and an 8 Ω load, the maximum power dissipation point is 625mW. The maximum power dissipation point obtained from Equation 4 must not be greater than the power dissipation results from Equation 5:

$$P_{DMAX} = (T_{JMAX} - T_A) / \theta_{JA} \quad (5)$$

Depending on the ambient temperature, T_A , of the system surroundings, Equation 5 can be used to find the maximum internal power dissipation supported by the IC packaging. If the result of Equation 4 is greater than that of Equation 5, then either the supply voltage must be decreased, the load impedance increased, the ambient temperature reduced, or the θ_{JA} reduced with heat-sinking. In many cases, larger traces near the output, VDD, and GND pins can be used to lower the θ_{JA} . The larger areas of copper provide a form of heat-sinking allowing higher power dissipation. Recall that internal power dissipation is a function of output power. If the typical operation is not around the maximum power dissipation point, the BL6211 can operate at higher ambient temperatures.

9.7 SHUTDOWN FUNCTION

In order to reduce power consumption while not in use, the BL6211 contains shutdown circuitry that is used to turn off the amplifier's bias circuitry. The shutdown pin should be tied to a definite voltage to avoid unwanted state changes. In many applications, a microcontroller or microprocessor output is used to control the shutdown circuitry, which provides a quick, smooth transition to shutdown. Another solution is to use a single-throw switch in conjunction with an external pull-down resistor. This scheme guarantees that the shutdown pin will not float, thus preventing unwanted state changes.

9.8 PCB LAYOUT

The residual resistance of the PCB trace between the amplifier output pins and the speaker causes a voltage drop, which results in power dissipated in the PCB trace and not in the speaker as desired. Therefore, to maintain the highest speaker power dissipation and widest output voltage swing, PCB trace that connects the amplifier output pins to the speaker must be as wide as possible.

Poor power supply regulation adversely affects maximum output power. A poorly regulated supply's output voltage decreases with increasing load current. Reduced supply voltage causes decreased headroom, output signal clipping, and reduced output power. Even with tightly regulated supplies, power supply trace resistance creates the same effects as poor supply regulation. Therefore, making the power supply trace as wide as possible helps to maintain full output voltage swing.

It is very important to keep the BL6211 external components very close to the BL6211 to limit noise pickup.

10 PHYSICAL DIMENSIONS

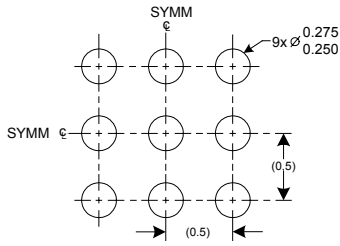

DIMENSIONS ARE IN MILLIMETERS

LAND PATTERN RECOMMENDATION

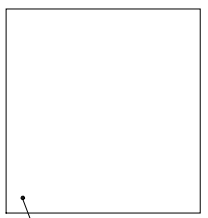

BUMP A1 CORNER

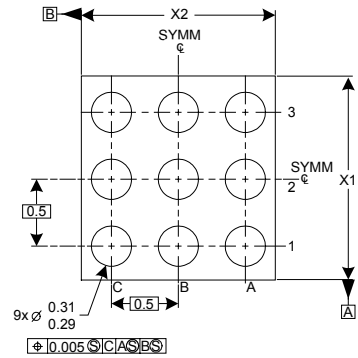
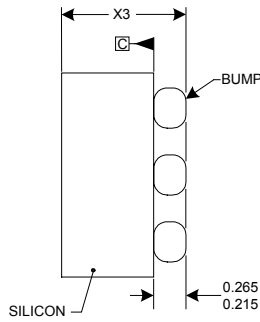

9-Bump micro SMD
Part Number BL6211ITLX
X1=1.514 ± 0.03 X2=1.514 ± 0.03 X3=0.600 ± 0.075

PHYSICAL DIMENSIONS (continued)

DIMENSIONS ARE IN MILLIMETERS

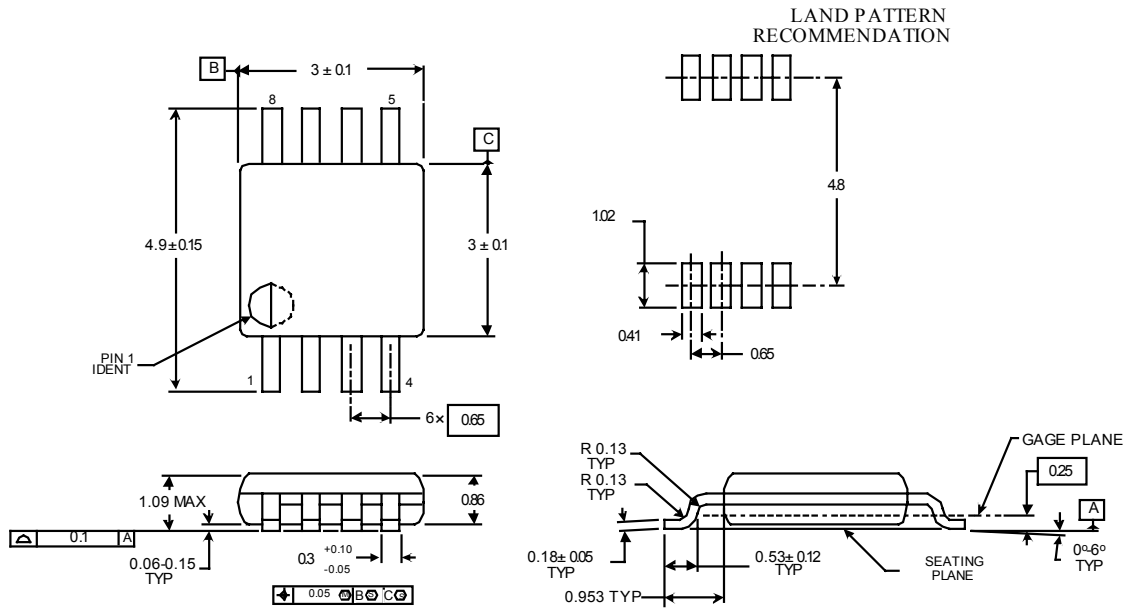

Mini Small Outline (MSOP8)
Part Number BL6211MM