

1. 2 Watt Audio Power Amplifier

Features

- Improved PSRR at 217 Hz 70dB
- Power output at 5.0V, 1% THD+N, 8Ω 1.2W (typ.)
- Power output at 3.0V, 1% THD+N, 8Ω 400 mW (typ.)
- Ultra low shutdown current 0.1 uA (typ.)
- 2.2V – 5.5V operation
- Improved circuitry eliminates pop-click noise during turn-on and turn-off transitions
- Excellent RFI (Radio Frequency Interference) immunity
- No output coupling capacitors, snubber networks or bootstrap capacitors required
- Unity-gain stable
- External gain configuration capability
- Available in space-saving package: NLGA9L

General Description

The BL6213 is a Class-AB audio power amplifier designed for mobile phones and other portable communication devices. It is capable of delivering 1.2 watts of continuous average power to an 8Ω BTL load with less than 1% distortion (THD+N) from a 5V_{DC} power supply.

The BL6213 was designed specifically to provide high quality output power with a minimal amount of external components. It does not require output coupling capacitors or bootstrap capacitors. And with ultra low shutdown current, the BL6213 is ideally suited for mobile phone and other low voltage applications where minimal power consumption is a primary requirement.

With special pop-click eliminating circuit, the BL6213 provides perfect pop-click characteristic during turn-on and turn-off transitions.

The BL6213 is unity-gain stable and can be configured by external gain-setting resistors.

Applications

- Wireless handsets
- Portable electronic devices
- PDAs, Handheld computers

Pin Diagrams

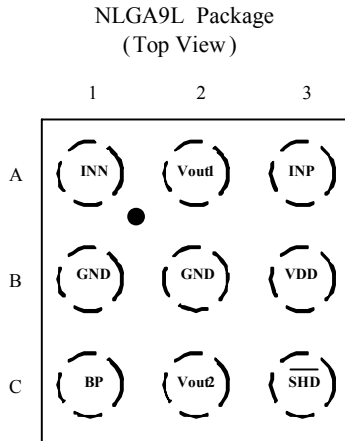

NLGA9L Marking
(Top View)

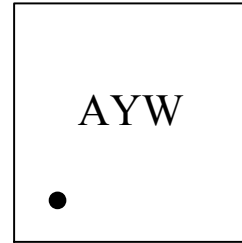

A - BL6213
Y - Year Code
W - Week Code

Pin Description

No.	Pin Name	I/O	Description
A1	INN	I	Negative Input
A2	Vout1	O	Negative BTL Output
A3	INP	I	Positive Input
B1/B2	GND	I/O	Ground
B3	VDD	I/O	Power Supply (2.2 – 5.5 V)
C1	BP	I/O	Analog ground for inner OPAs. It's about a half of VDD.
C2	Vout2	O	Positive BTL Output
C3	SHD	I	Shout-down Logical Control, '0' is active.

Typical Application Circuit

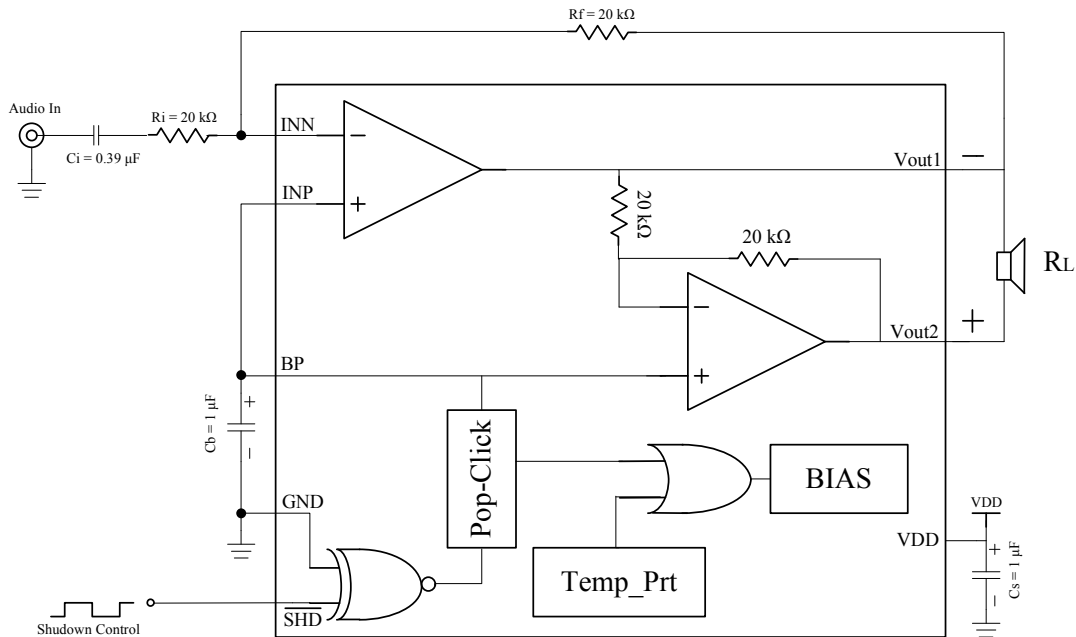

FIGURE 1. BL6213 Typical Application Circuit

External Components Description

Components	Functional Description
R_i	Inverting input resistance which sets the closed-loop gain in conjunction with R_f . This resistor also forms a high pass filter with C_i at $f_c = 1/(2\pi R_i * C_i)$.
C_i	Input coupling capacitor which blocks the DC voltage at the amplifiers input terminates. Also creates a high-pass filter with R_i at $f_c = 1/(2\pi R_i * C_i)$.
R_f	Feedback resistance which sets the closed-loop gain in conjunction with R_i .
C_s	Supply bypass capacitor which provides power supply filtering.
C_b	Bypass pin capacitor which provides half-supply filtering. Refer to the section.

Absolute Maximum Ratings

Supply Voltage	-0.3V to 6V
Input Voltage	-0.3V to $V_{DD}+0.3V$
Junction Temperature	-40°C to +150°C
Storage Temperature	-65°C to +150°C

Operating Ratings

Temperature Range	$-40^\circ\text{C} \leq T_A \leq 85^\circ\text{C}$
Supply Voltage	$2.2V \leq V_{DD} \leq 5.5V$

NOTE: Absolute Maximum Ratings indicate limits beond which damage to the device may occur. performance limits.
Operating Rating indicate conditions for which the device is functional, but do not guarantee specific

Electrical Characteristics

The following specifications apply for the circuit shown in Figure 1, unless otherwise specified. Limits apply for $T_A = 25^\circ\text{C}$.

□ $V_{DD} = 5V$

Symbol	Parameter	Conditions	Spec			Units
			Min.	Typ.	Max.	
I_{DD}	Quiescent Power Supply Current	$V_{IN} = 0V, 8\Omega$ Load		3.6	8	mA
		$V_{IN} = 0V, \text{No Load}$		3.3	7	mA
I_{SD}	Shutdown Current	$V_{IN}=0V, V_{SHD}=GND, \text{No Load}$		0.1	2	uA
V_{SDIH}	Shutdown Voltage Input High		1.3			V
V_{SDIL}	Shutdown Voltage Input Low				0.8	V
V_{OS}	Output Offset Voltage		-50	6	50	mV
THD+N	Total Harmonic Distortion+Noise	$P_o=0.5W_{rms}, f=1KHz,$		0.13		%
P_o	Output Power	THD+N $\leq 1\%, f=1KHz, 8\Omega$ Load	0.9	1.2		W
PSRR	Power Supply Rejection Ratio	Input terminated with $10\Omega, V_{DDRIPPLE}=0.2V_{P-P}, f=217Hz$	55	68		dB
		Input terminated with $10\Omega, V_{DDRIPPLE}=0.2V_{P-P}, f=1KHz$	55	65		dB
T_{WU}	Wake-up time			150		ms

□ $V_{DD} = 3V$

Symbol	Parameter	Conditions	Spec			Units
			Min.	Typ.	Max.	
I_{DD}	Quiescent Power Supply Current	$V_{IN} = 0V, 8\Omega$ Load		3.0	7	mA
		$V_{IN} = 0V, \text{No Load}$		2.6	6	mA
I_{SD}	Shutdown Current	$V_{IN}=0V, V_{SHD}=GND, \text{No Load}$		0.1	2	uA
V_{SDIH}	Shutdown Voltage Input High		1.1			V
V_{SDIL}	Shutdown Voltage Input Low				0.6	V

V_{OS}	Output Offset Voltage		-50	6	50	mV
THD+N	Total Harmonic Distortion+Noise	$P_O=0.25W_{rms}$, $f=1KHz$,		0.10		%
P_O	Output Power	THD+N \leq 1%, $f=1KHz$, 8 Ω Load		400		mW
PSRR	Power Supply Rejection Ratio	Input terminated with 10 Ω , $V_{DDRIPPLE}=0.2V_{P-P}$, $f=217Hz$	55	70		dB
		Input terminated with 10 Ω , $V_{DDRIPPLE}=0.2V_{P-P}$, $f=1KHz$	55	65		dB
T_{WU}	Wake-up time			132		ms

□ $V_{DD} = 2.6V$

Symbol	Parameter	Conditions	Spec			Units
			Min.	Typ.	Max.	
I_{DD}	Quiescent Power Supply Current	$V_{IN} = 0V$, 8 Ω Load		2.7		mA
		$V_{IN} = 0V$, No Load		2.5		mA
I_{SD}	Shutdown Current	$V_{IN}=0V$, $V_{SHD}=GND$, No Load		0.1		μA
V_{OS}	Output Offset Voltage		-50	4	50	mV
THD+N	Total Harmonic Distortion+Noise	$P_O=0.15W_{rms}$, $f=1KHz$,		0.1		%
P_O	Output Power	THD+N \leq 1%, $f=1KHz$, 8 Ω Load		300		mW
PSRR	Power Supply Rejection Ratio	Input terminated with 10 Ω , $V_{DDRIPPLE}=0.2V_{P-P}$, $f=217Hz$	55	71		dB
		Input terminated with 10 Ω , $V_{DDRIPPLE}=0.2V_{P-P}$, $f=1KHz$	55	65		dB
T_{WU}	Wake-up time			126		ms

Typical Performance Characteristics

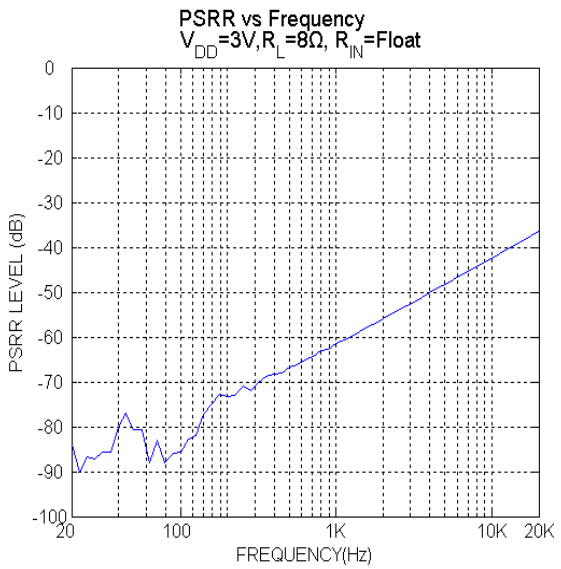
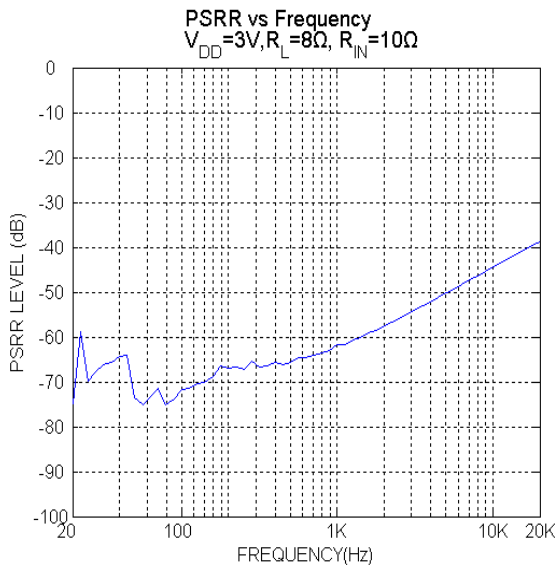
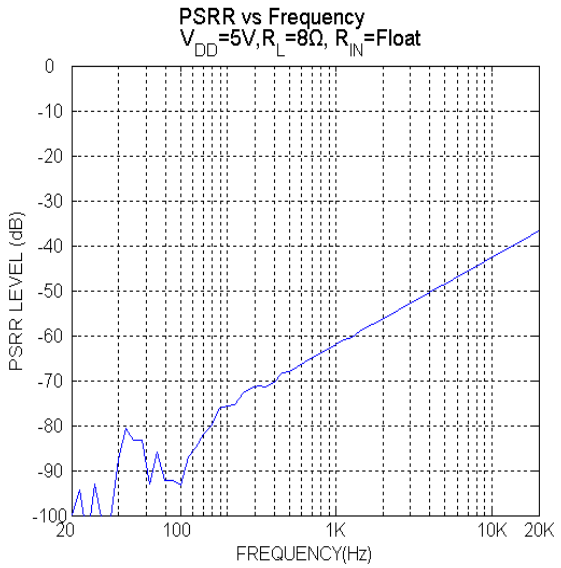
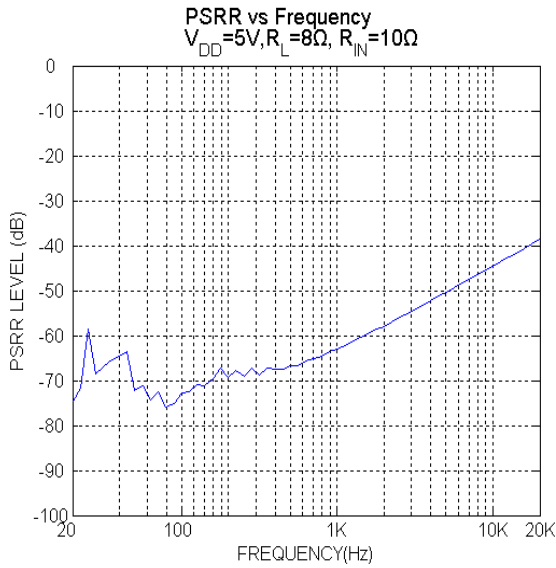
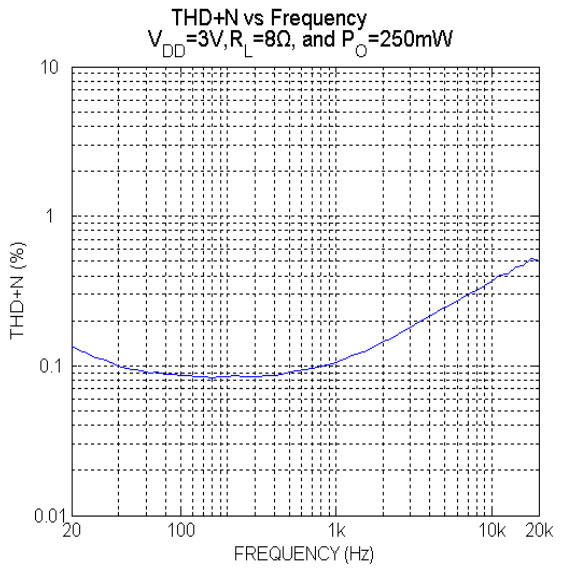
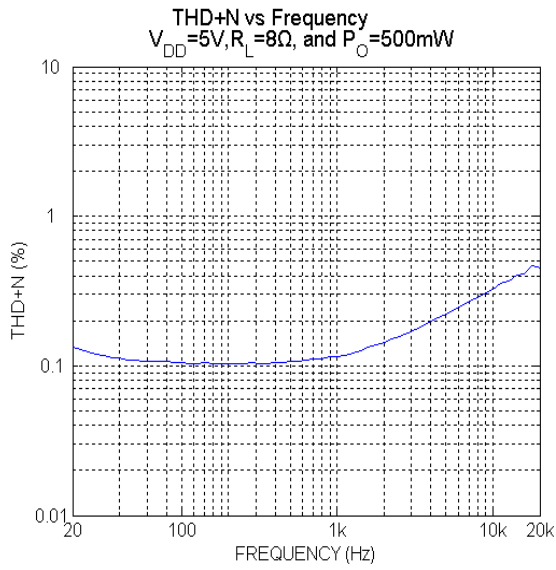

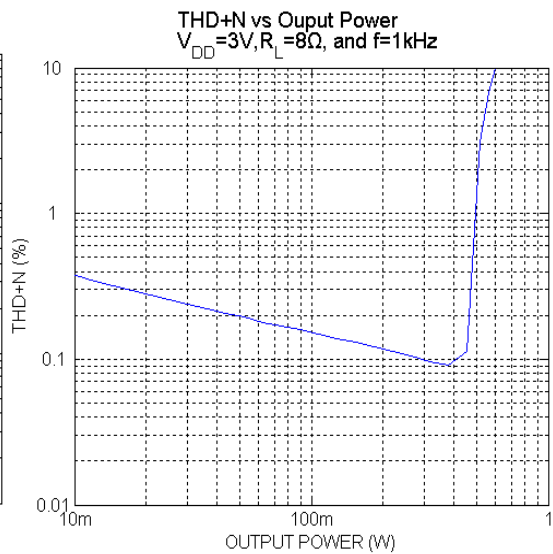
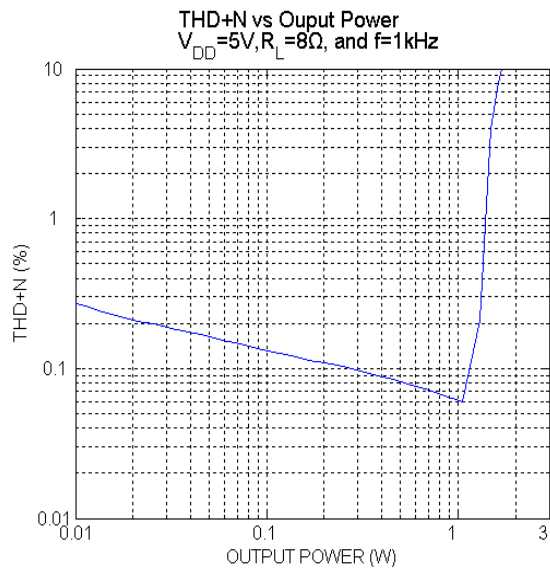

Package Dimensions

NLGA9L PACKAGE

