

1.25 Watt Audio Power Amplifier

Features

- Improved PSRR at 217 Hz & 1 KHz 64 dB
- Power output at 5.0V, 1% THD+N, 8Ω 1.25 W (typ.)
- Power output at 3.0V, 1% THD+N, 8Ω 450 mW (typ.)
- Ultra low shutdown current 0.1 uA (typ.)
- 2.2V – 5.5V operation
- Improved circuitry eliminates pop-click noise during turn-on and turn-off transitions
- No output coupling capacitors, snubber networks or bootstrap capacitors required
- Unity-gain stable
- External gain configuration capability
- Available in space-saving packages: MSOP8,SOP8

General Description

The BL6290 is a Class-AB audio power amplifier designed for mobile phones and other portable communication devices. It is capable of delivering 1.25 watts of continuous average power to an 8Ω BTL load with less than 1% distortion (THD+N) from a 5V_{DC} power supply.

The BL6290 was designed specifically to provide high quality output power with a minimal amount of external components. It does not require output coupling capacitors or bootstrap capacitors. And with ultra low shutdown current, the BL6290 is ideally suited for mobile phone and other low voltage applications where minimal power consumption is a primary requirement.

With special pop-click eliminating circuit, the BL6290 provides perfect pop-click characteristic during turn-on and turn-off transitions.

The BL6290 is unity-gain stable and can be configured by external gain-setting resistors.

Applications

- Wireless handsets
- Portable electronic devices
- PDAs, Handheld computers

Pin Diagrams

Mini Small Outline Package (MSOP8/SOP8)
(Top View)

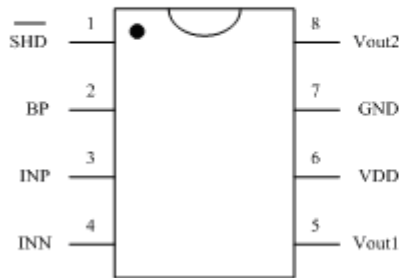

MSOP8/SOP8 Marking
(Top View)



Y - Year Code
 WK - Week Code
 BDG - BL6290 MSOP8/SOP8 ROHS

Pin Description

No.	Pin Name	I/O	Description
1	$\overline{\text{SHD}}$	I	Shout-down Logical Control, '0' is active.
2	BP	I/O	Analog ground for inner OPAs. It's about a half of VDD.
3	INP	I	Positive Input
4	INN	I	Negative Input
5	Vout1	O	Negative BTL Output
6	VDD	I/O	Power Supply (2.2 – 5.5 V)
7	GND	I/O	Ground
8	Vout2	O	Positive BTL Output

Typical Application Circuit

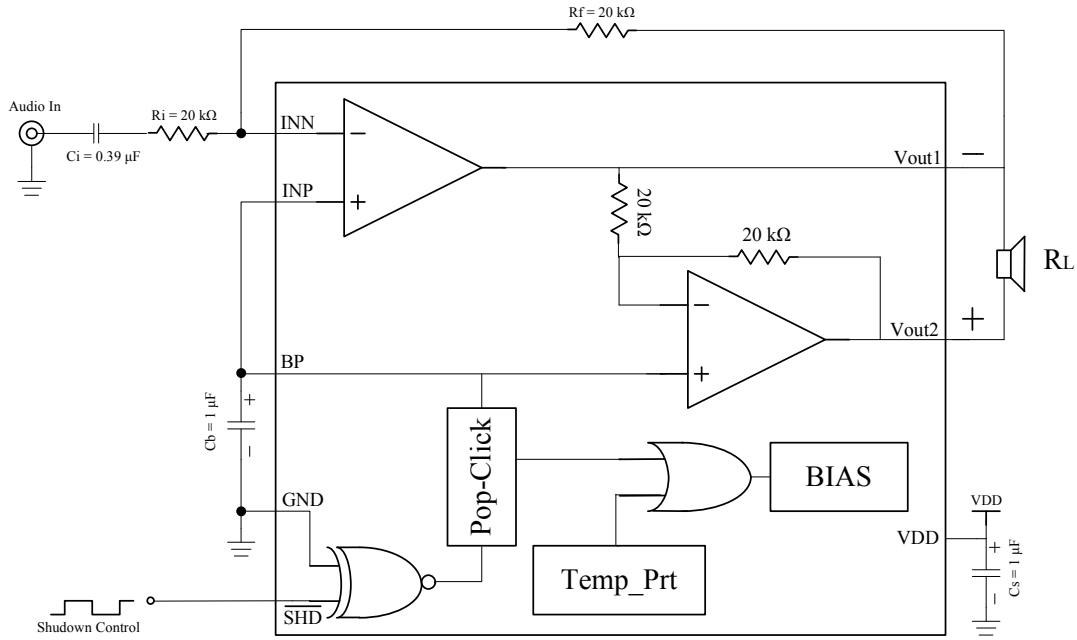

FIGURE 1. BL6290 Typical Application Circuit

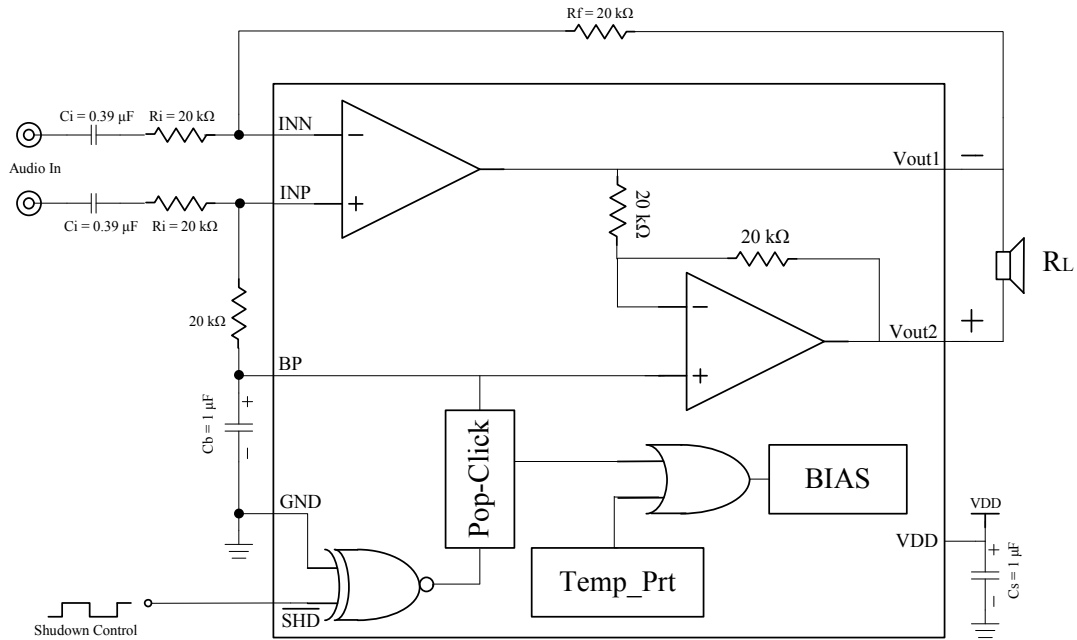

FIGURE 2. BL6290 Differential Amplifier Configuration

External Components Description

Components	Functional Description
Ri	Inverting input resistance which sets the closed-loop gain in conjunction with Rf. This resistor also forms a high pass filter with Ci at $f_c = 1/(2\pi R_i * C_i)$.
Ci	Input coupling capacitor which blocks the DC voltage at the amplifiers input terminates. Also creates a high-pass filter with Ri at $f_c = 1/(2\pi R_i * C_i)$.
Rf	Feedback resistance which sets the closed-loop gain in conjunction with Ri.
Cs	Supply bypass capacitor which provides power supply filtering.
Cb	Bypass pin capacitor which provides half-supply filtering. Refer to the section.

Absolute Maximum Ratings

Supply Voltage -0.3V to 6V

Input Voltage -0.3V to VDD+0.3V

Power Dissipation

See Dissipation Rating Table

Junction Temperature -40°C to +150°C

Storage Temperature -65°C to +150°C

Thermal Resistance

 θ_{JC} (MSOP8) 56°C/W

 θ_{JA} (MSOP8) 190°C/W

 θ_{JA} (SOP8) 184°C/W

Operating Ratings

 Temperature Range $-40^\circ\text{C} \leq T_A \leq 85^\circ\text{C}$

 Supply Voltage $2.2\text{V} \leq V_{DD} \leq 5.5\text{V}$
NOTE: Absolute Maximum Ratings indicate limits beyond which damage to the device may occur.
Operating Rating indicate conditions for which the device is functional, but do not guarantee specific performance limits.

Electrical Characteristics

The following specifications apply for the circuit shown in Figure 1, unless otherwise specified. Limits apply for $T_A = 25^\circ\text{C}$.

□ $V_{DD} = 5\text{V}$

Symbol	Parameter	Conditions	Spec			Units
			Min.	Typ.	Max.	
I_{DD}	Quiescent Power Supply Current	$V_{IN} = 0\text{V}$, 8Ω Load		4	8	mA
		$V_{IN} = 0\text{V}$, No Load		3.6	7	mA
I_{SD}	Shutdown Current	$V_{IN}=0\text{V}$, $V_{SHD}=\text{GND}$, No Load		0.1	2	μA
V_{SDIH}	Shutdown Voltage Input High			0.93		V
V_{SDIL}	Shutdown Voltage Input Low			0.76		V
V_{OS}	Output Offset Voltage		-50	6	50	mV
THD+N	Total Harmonic Distortion+Noise	$P_o=0.5\text{Wrms}$, $f=1\text{KHz}$,		0.06		%
P_o	Output Power	THD+N $\leq 1\%$, $f=1\text{KHz}$, 8Ω Load	0.9	1.25		W
PSRR	Power Supply Rejection Ratio	Input terminated with 10Ω , $V_{DD\text{RIPPLE}}=0.2\text{V}_{\text{P-P}}$, $f=217\text{Hz}$	55	61		dB
		Input terminated with 10Ω , $V_{DD\text{RIPPLE}}=0.2\text{V}_{\text{P-P}}$, $f=1\text{KHz}$	55	64		dB
T_{WU}	Wake-up time			100		ms
R_{OUT}	Resistor Output to GND		5.8	8.3	10	$\text{k}\Omega$

□ $V_{DD} = 3\text{V}$

Symbol	Parameter	Conditions	Spec			Units
			Min.	Typ.	Max.	
I_{DD}	Quiescent Power Supply Current	$V_{IN} = 0\text{V}$, 8Ω Load		3.3	7	mA
		$V_{IN} = 0\text{V}$, No Load		3.2	6	mA
I_{SD}	Shutdown Current	$V_{IN}=0\text{V}$, $V_{SHD}=\text{GND}$, No Load		0.1	2	μA
V_{SDIH}	Shutdown Voltage Input High			0.85		V
V_{SDIL}	Shutdown Voltage Input Low			0.69		V
V_{OS}	Output Offset Voltage		-50	6	50	mV
THD+N	Total Harmonic Distortion+Noise	$P_o=0.25\text{Wrms}$, $f=1\text{KHz}$,		0.05		%

P _O	Output Power	THD+N<=1%, f=1KHz, 8Ω Load		450		mW
PSRR	Power Supply Rejection Ratio	Input terminated with 10Ω, V _{DDRIPPLE} =0.2V _{P-P} , f=217Hz	55	64		dB
		Input terminated with 10Ω, V _{DDRIPPLE} =0.2V _{P-P} , f=1KHz	55	68		dB
T _{WU}	Wake-up time			78		ms
R _{OUT}	Resistor Output to GND		5.8	8.3	10	kΩ

□ V_{DD} = 2.6V

Symbol	Parameter	Conditions	Spec			Units
			Min.	Typ.	Max.	
I _{DD}	Quiescent Power Supply Current	V _{IN} = 0V, 8Ω Load		2.6		mA
		V _{IN} = 0V, No Load		2.4		mA
I _{SD}	Shutdown Current	V _{IN} =0V, V _{SHD} =GND, No Load		0.1		uA
V _{OS}	Output Offset Voltage		-50	4	50	mV
THD+N	Total Harmonic Distortion+Noise	Po=0.15Wrms, f=1KHz,		0.05		%
P _O	Output Power	THD+N<=1%, f=1KHz, 8Ω Load		330		mW
PSRR	Power Supply Rejection Ratio	Input terminated with 10Ω, V _{DDRIPPLE} =0.2V _{P-P} , f=217Hz	55	63		dB
		Input terminated with 10Ω, V _{DDRIPPLE} =0.2V _{P-P} , f=1KHz	55	63		dB
T _{WU}	Wake-up time			70		ms
R _{OUT}	Resistor Output to GND		5.8	8.3	10	kΩ

Typical Performance Characteristics

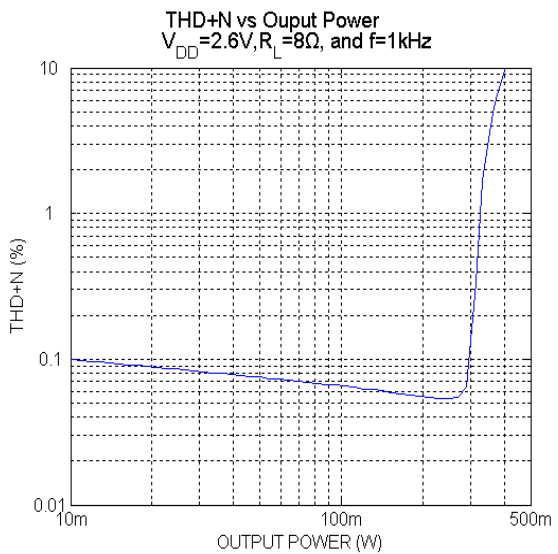
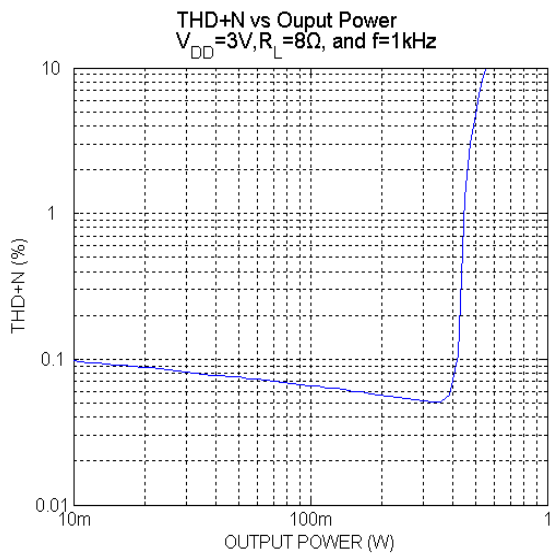
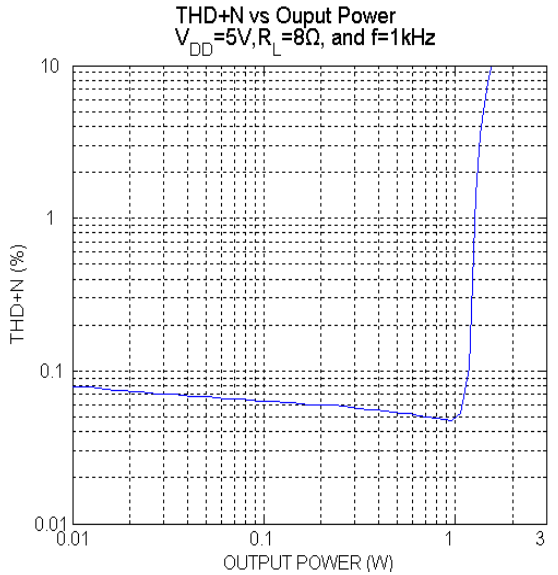
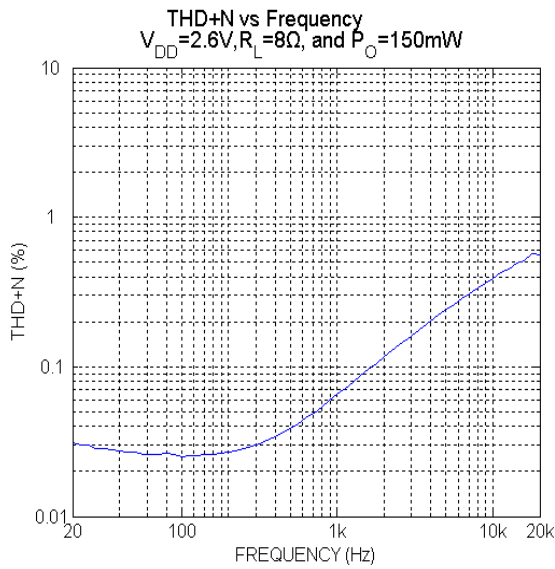
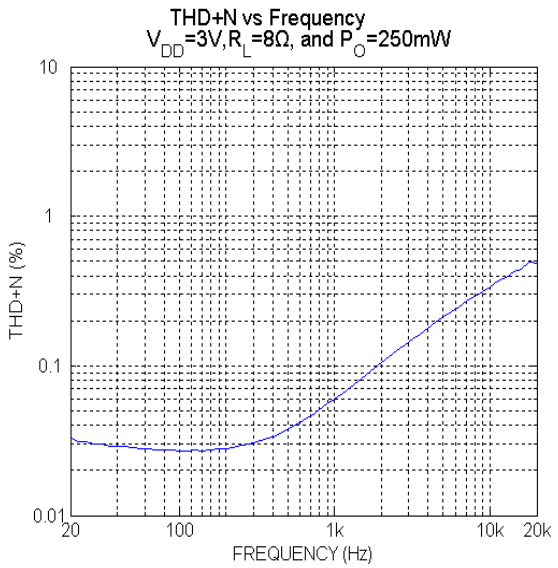
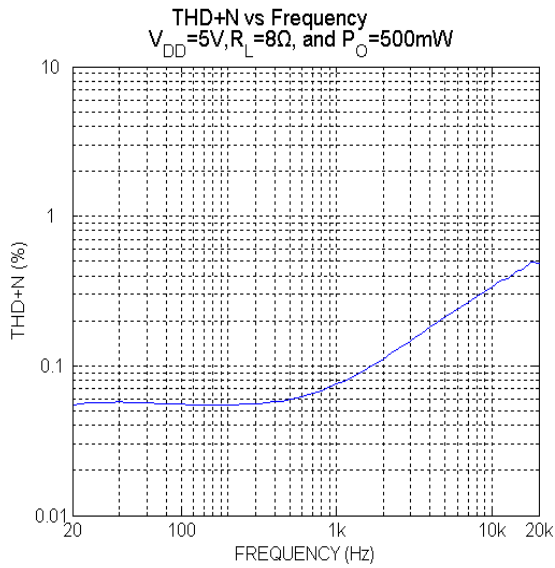

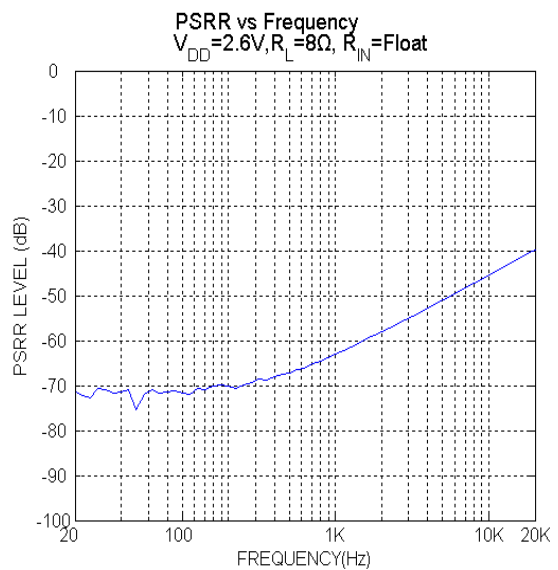
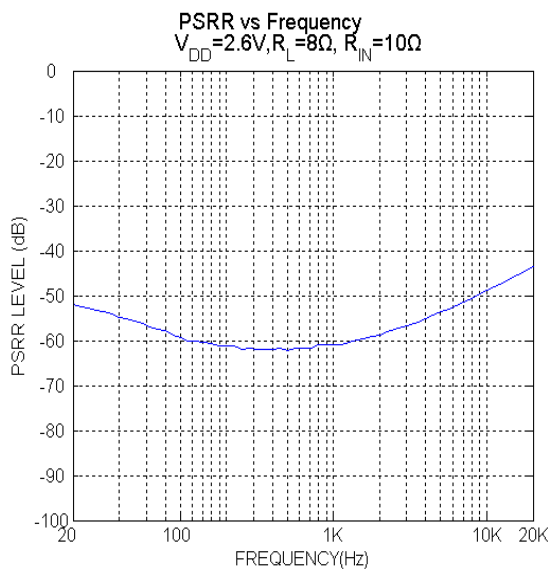
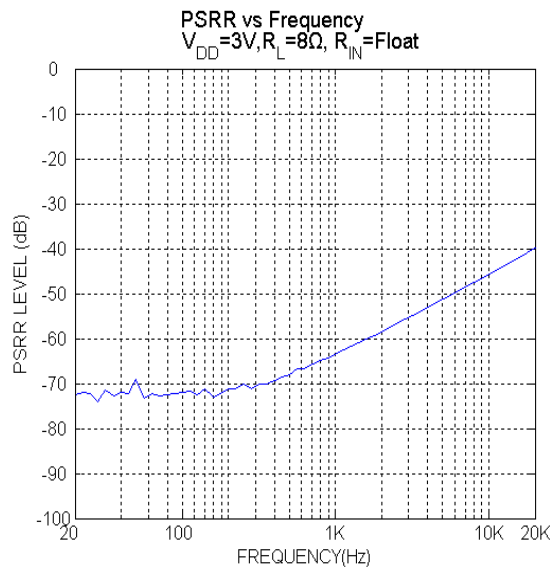
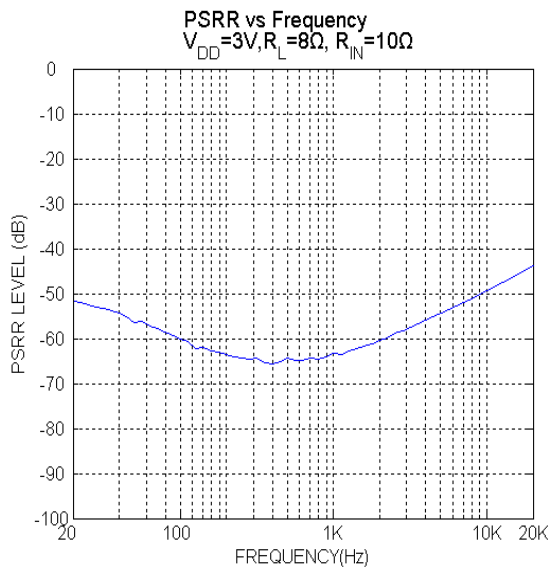
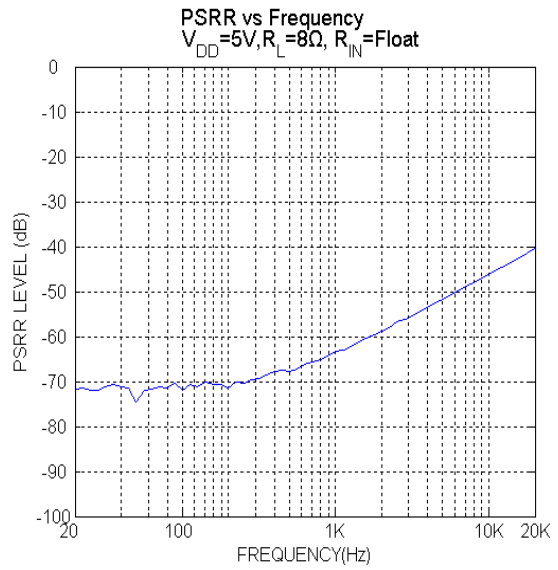
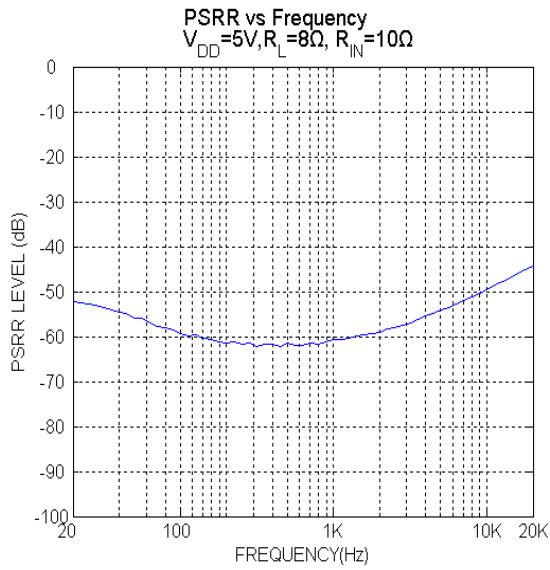

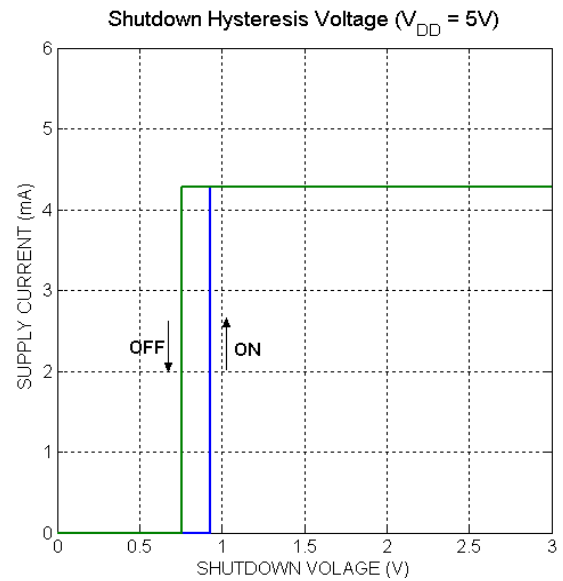
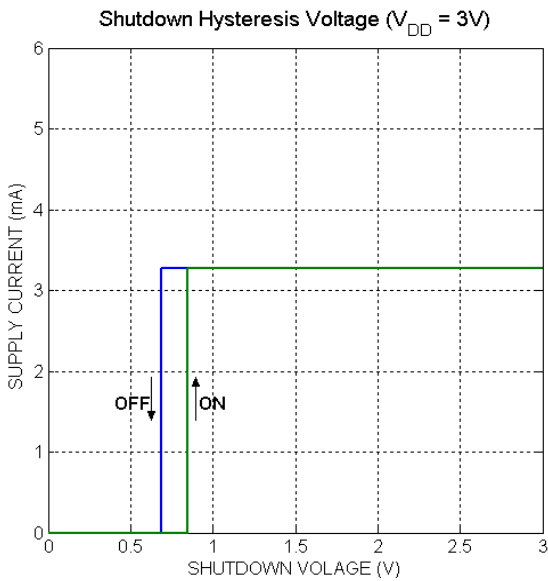
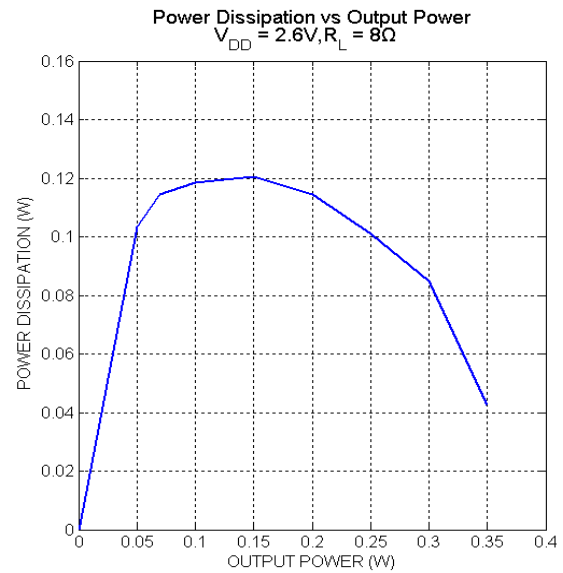
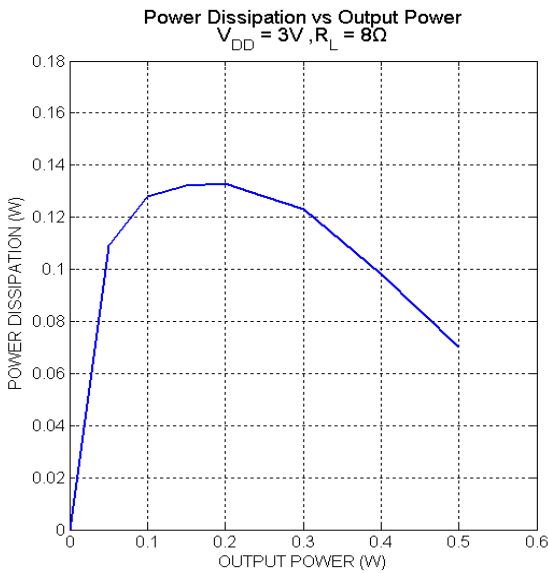
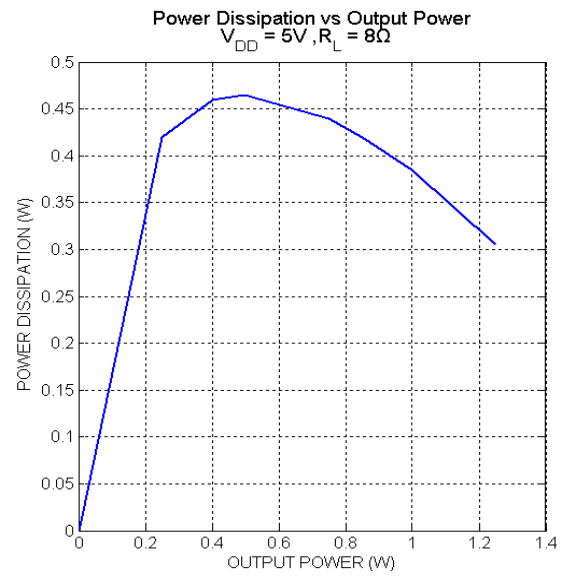
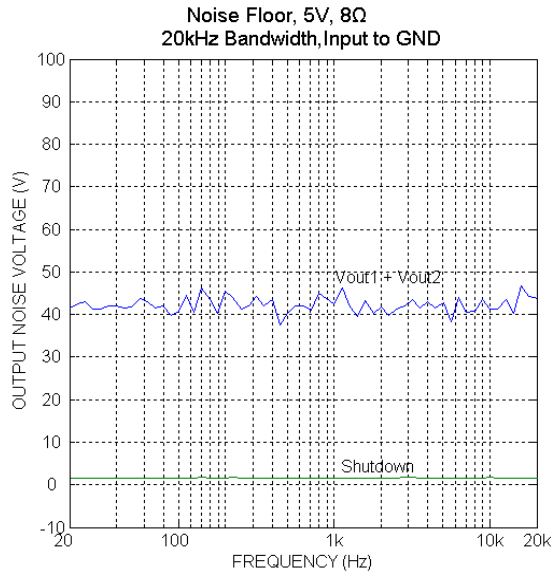

Output Power vs Supply Voltage
 $f = 1\text{kHz}$, $R_L = 8\Omega$

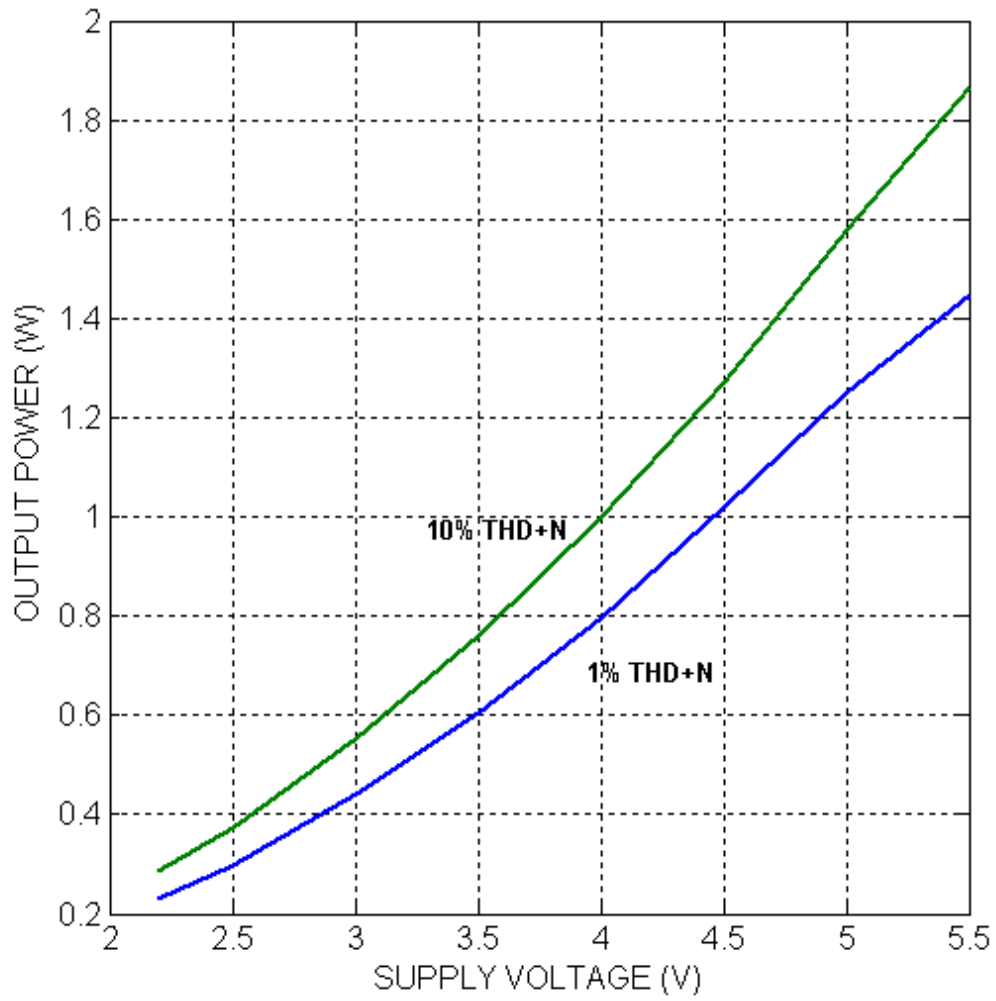

Package Dimensions

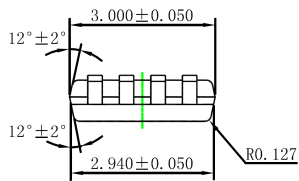
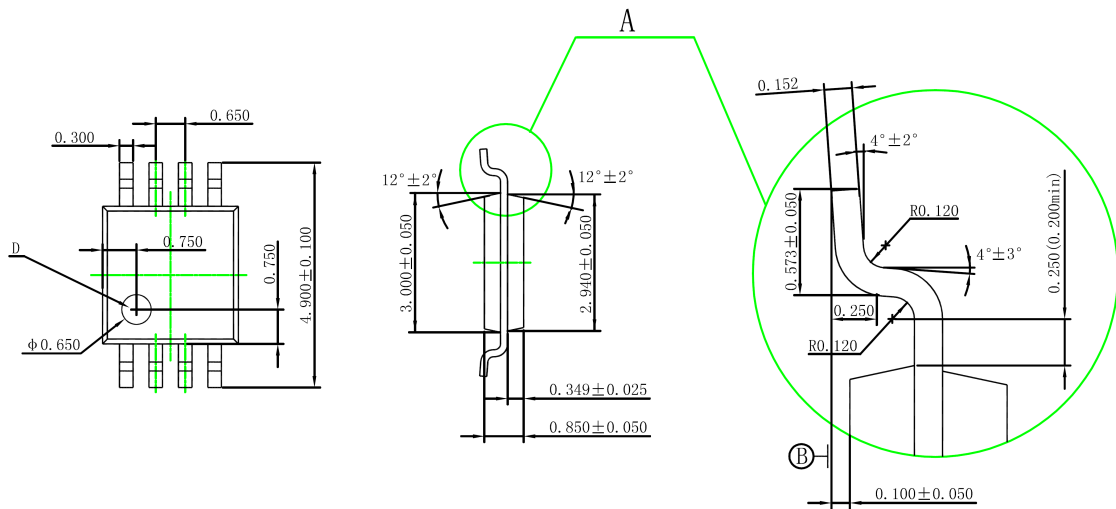

MSOP8

All dimension values are in millimeter.

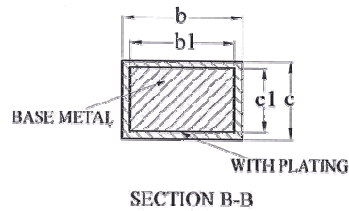
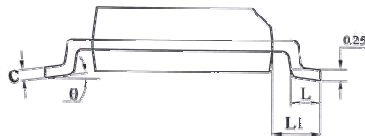
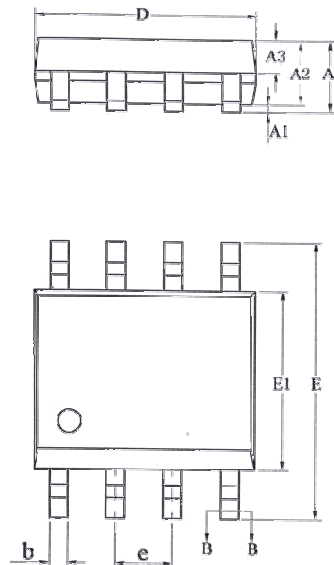

SYMBOL	MILLIMETER		
	MIN	NOM	MAX
A	—	—	1.77
A1	0.08	0.18	0.28
A2	1.20	1.40	1.60
A3	0.55	0.65	0.75
b	0.39	—	0.48
b1	0.38	0.41	0.43
c	0.21	—	0.26
c1	0.19	0.20	0.21
D	4.70	4.90	5.10
E	5.80	6.00	6.20
E1	3.70	3.90	4.10
e	1.27BSC		
L	0.50	0.65	0.80
L1	1.05BSC		
θ	0	—	8°

SOP8