

## High Efficiency 1.2MHz 30V Boost LED Driver

### DESCRIPTION

BL8040 is a step-up converter designed for driving up to 7 series white LED's from a single cell Lithium Ion battery. Its low 250mV feedback voltage reduces power loss and improves efficiency.

Optimized operation frequency can meet the requirement of small LC filters value and low operation current with high efficiency. Internal soft start function can reduce the inrush current. Tiny package type provides the best solution for PCB space saving and total BOM cost.

BL8040 is available in SOT23-6 package that is Pb free.

### FEATURES

- 2.5V to 5.5V Input Voltage
- Drives up to 8 Series WLEDs
- Low 250mV Feedback Voltage
- 1.2MHz Fixed Switching Frequency
- Internal 1.6A Switch Current Limit
- Internal Compensation
- Thermal Shutdown
- Over Voltage Protection
- Dimming with wide Frequency Range
- Available in SOT23-6 Package

### APPLICATIONS

- Camera Flash White LED
- PDA LED back light
- Digital still cameras

### TYPICAL APPLICATION

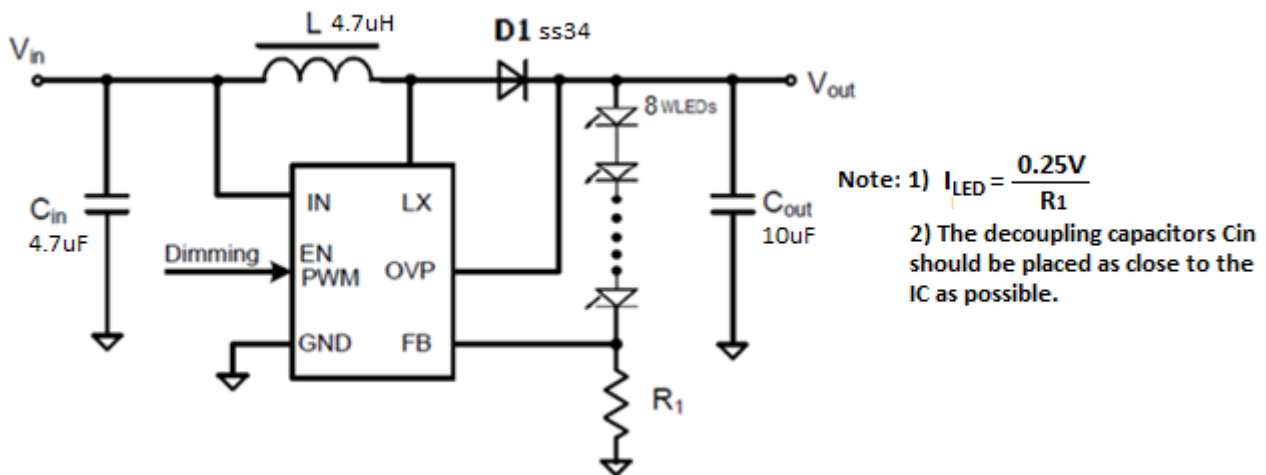

Figure1. BL8040 Typical Application Circuit

### ORDERING INFORMATION

BL8040 ①②③

| Code | Description   |
|------|---|
| 1    | Temperature & Rohs:<br>C: -40~85°C, Pb Free Rohs Std. |
| 2    | Package Type:<br>B6: SOT-23-6                         |
| 3    | Packing Type:<br>TR: Tape & Reel (Standard)           |

### MARKING INFORMATION

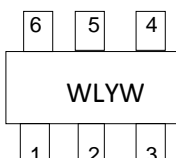
| Product Classification |                  | BL8040CB6TR   |
|------------------------|------------------|---|
| Marking                |                  |  |
| WLYW                   | WL: Product Code |   |
|                        | YW: Date Code    |   |

## PIN DESCRIPTION

| Pin No. | Symbol | Description  |
|---------|--------|--|
| 1       | LX     | Power Switch Output. LX is the drain of the internal MOSFET switch. Connect the power inductor and output rectifier to LX. LX can swing between GND and 30V. |
| 2       | GND    | Ground.  |
| 3       | FB     | Feedback Input. The FB voltage is 0.25V. Connect a resistor divider to FB.   |
| 4       | EN     | Chip enable, but a PWM signal with various duty cycle can directly sent to EN pin to achieve the backlight dimming.  |
| 5       | OVP    | Over Voltage Input. OV measures the output voltage for open circuit protection. Connect OV to the output at the top of the LED string.                       |
| 6       | IN     | Power Supply. Must be locally bypassed.  |

## ABSOLUTE MAXIMUM RATING

| Parameter                              | Value          |         |
|--|----------------|---------|
| IN, EN Pin Voltage                     | -0.3V to 6V    |         |
| SW Pin Voltage                         | -0.3V to 30V   |         |
| All Other Pin Voltage                  | -0.3V to 6V    |         |
| Junction Temperature (T <sub>j</sub> ) | 150°C          |         |
| Ambient Temperature (T <sub>A</sub> )  | -40°C to 85°C  |         |
| Power Dissipation                      | 600mW          |         |
| Thermal Resistance (θ <sub>JA</sub> )  | SOT23-6        | 250°C/W |
| Thermal Resistance (θ <sub>JC</sub> )  |                | 130°C/W |
| Storage Temperature (T <sub>s</sub> )  | -65°C to 150°C |         |
| Lead Temperature & Time                | 260°C, 10Sec   |         |

## RECOMMENDED WORK CONDITIONS

| Parameter                                       | Value                  |
|---|------------------------|
| Input Voltage Range                             | 2.5V to 5.5V           |
| Output Voltage Range                            | V <sub>IN</sub> to 30V |
| Operating Junction Temperature(T <sub>j</sub> ) | -40°C –125°C           |

## ELECTRICAL CHARACTERISTICS

(T<sub>a</sub>=25°C, unless otherwise noted)

| Symbol             | Item                    | Conditions                            | Min. | Typ. | Max. | Unit |
|--------------------|-------------------------|---------------------------------------|------|------|------|------|
| V <sub>IN</sub>    | Operating Input Voltage |                                       | 2.5  |      | 5.5  | V    |
| V <sub>FB</sub>    | Feedback Voltage        |                                       | 237  | 250  | 263  | mV   |
| I <sub>FB</sub>    | FB input Bias Current   |                                       | -50  | -10  |      | nA   |
|                    | SW Leakage              | V <sub>SW</sub> =20V                  |      |      | 1    | uA   |
| I <sub>Q</sub>     | Quiescent Current       | V <sub>FB</sub> =0.2V, Switch         |      | 0.15 | 0.3  | mA   |
|                    |                         | V <sub>EN</sub> =0V                   |      | 0.1  | 1    | uA   |
| F <sub>SW</sub>    | Oscillator Frequency    |                                       |      | 1.2  |      | MHz  |
| D <sub>MAX</sub>   | Maximum Duty Cycle      |                                       |      | 90   |      | %    |
| V <sub>EN</sub>    | EN Threshold            |                                       |      | 1    |      | V    |
| V <sub>OVP</sub>   | OVP Threshold           |                                       |      | 28   |      | V    |
|                    | SW On-Resistance        |                                       |      | 400  | 650  | mΩ   |
| I <sub>LIMIT</sub> | Current Limit           | V <sub>IN</sub> =4V, Duty Cycle = 50% |      | 1.6  |      | A    |
|                    | Thermal Shutdown        |                                       |      | 160  |      | °C   |

## TYPICAL PERFORMANCE CHARACTERISTICS

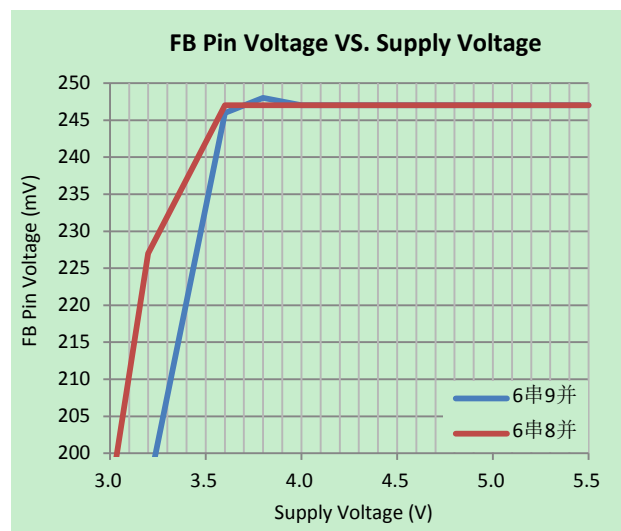
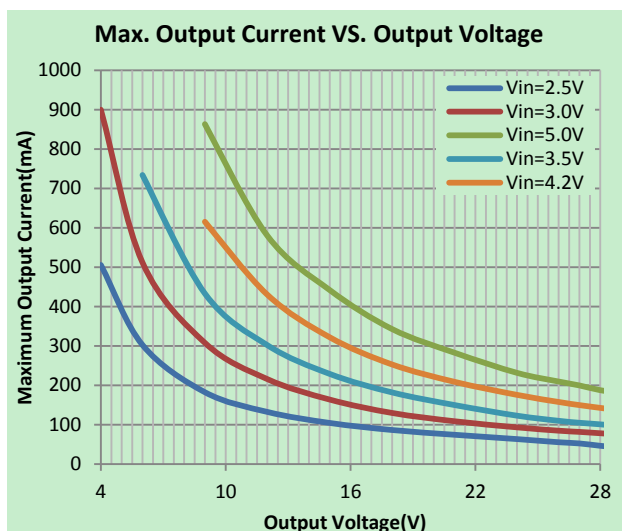
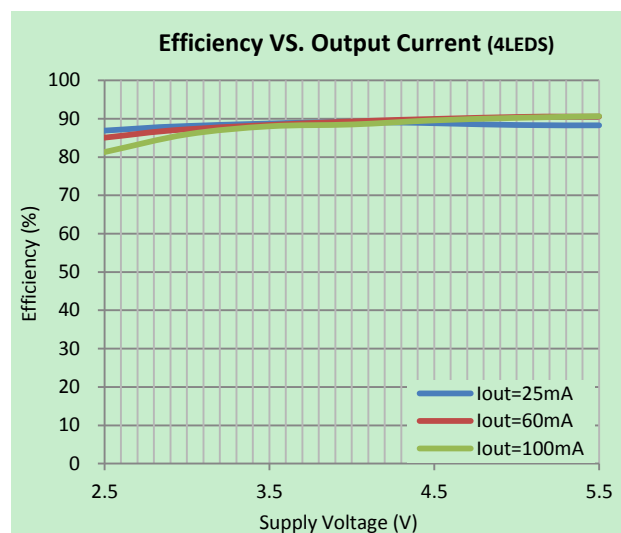
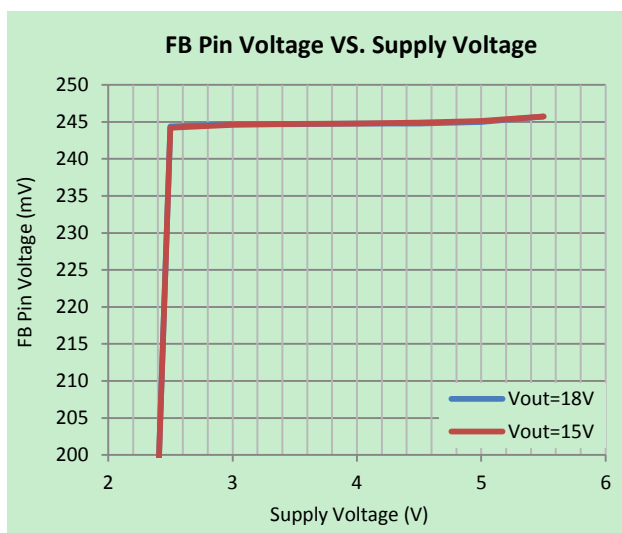
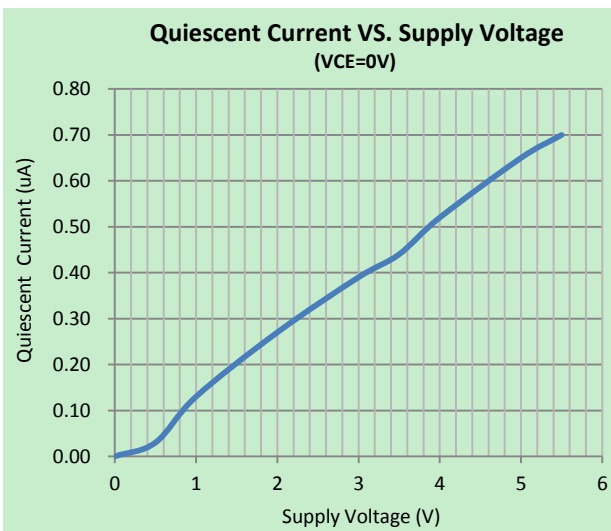
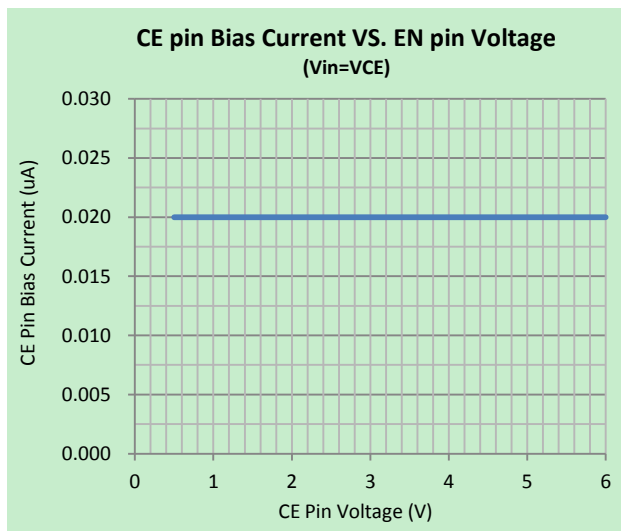

## PWM BRIGHTNESS DIMMING CONTROL at EN PIN

When EN pin is forced a PWM signal with frequency higher than 20KHz, the chip is in dimming mode. The internal circuit changes the feedback voltage according to the duty cycle of the PWM signal. The feedback voltage (Vfb) is simply defined as below:

$$V_{fb} = 250\text{mV} \times \text{Duty Cycle (\%)}$$

To shut down the chip, one has to make the EN signal low, and keep its low state for more than 2.5ms.

## PACKAGE INFORMATION

| Package  | SOT-23-6 | Devices per reel | 3000Pcs | Unit | mm |
|--|----------|------------------|---------|------|----|
| Package dimension:   |          |                  |         |      |    |
| <p>The technical drawing shows the SOT-23-6 package with the following dimensions (in mm):</p> <ul style="list-style-type: none"> <li>Top view: Total width <math>2.9 \pm 0.2</math>, distance between pins 4 and 5 <math>1.9 \pm 0.2</math>, and individual pin spacing of <math>0.95</math>.</li> <li>Side view: Total height <math>2.8 \pm 0.3</math>, distance from top surface to pin base <math>1.6 \pm 0.2</math>, and pin height <math>0.4 \pm 0.1</math>.</li> <li>Bottom view: Pin width <math>1.1 \pm 0.2</math>, distance from bottom surface to pin base <math>0.8 \pm 0.1</math>, and a gap of <math>0</math> to <math>0.1</math> between the package and the pin.</li> <li>Pin 1 width: <math>0.15 \pm 0.1</math> with a minimum length of <math>0.2</math> MIN.</li> </ul> |          |                  |         |      |    |