

# BLA1011-200; BLA1011S-200

Avionics LDMOS transistor

Rev. 08 — 26 October 2005

Product data sheet

## 1. Product profile

### 1.1 General description

200 W LDMOS avionics power transistor for transmitter applications at frequencies from 1030 MHz to 1090 MHz.

**Table 1: Typical performance**

RF performance at  $T_h = 25^\circ\text{C}$  in a common source class-AB test circuit;  $I_{Dq} = 150\text{ mA}$ ; typical values.

Mode of operation	Conditions	$V_{DS}$ (V)	$P_L$ (W)	$G_p$ (dB)	$\eta_D$ (%)	$t_r$ (ns)	$t_f$ (ns)
Pulsed class-AB: 1030 MHz to 1090 MHz	$t_p = 50\ \mu\text{s}$ ; $\delta = 2\%$	36	200	15	50	35	6
	$t_p = 128\ \mu\text{s}$ ; $\delta = 2\%$	36	250	14	50	35	6
	$t_p = 340\ \mu\text{s}$ ; $\delta = 1\%$	36	250	14	50	35	6

#### CAUTION



This device is sensitive to ElectroStatic Discharge (ESD). Therefore care should be taken during transport and handling.

### 1.2 Features

- Typical pulsed class-AB performance at a frequencies from 1030 MHz to 1090 MHz, a supply voltage of 36 V and an  $I_{Dq}$  of 150 mA:
  - ◆ Load power  $\geq 200\text{ W}$
  - ◆ Gain  $\geq 13\text{ dB}$
  - ◆ Efficiency  $\geq 45\%$
  - ◆ Rise time  $\leq 50\text{ ns}$
  - ◆ Fall time  $\leq 50\text{ ns}$
- High power gain
- Easy power control
- Excellent ruggedness
- Source on mounting flange eliminates DC isolators, reducing common mode inductance

### 1.3 Applications

- Avionics transmitter applications in the 1030 MHz to 1090 MHz frequency range.

# PHILIPS

## 2. Pinning information

Table 2: Pinning

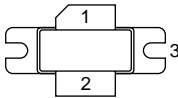
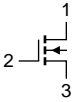
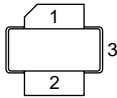
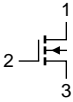
Pin	Description	Simplified outline	Symbol
<b>BLA1011-200 (SOT502A)</b>			
1	drain		 sym039
2	gate		
3	source		
<b>BLA1011S-200 (SOT502B)</b>			
1	drain		 sym039
2	gate		
3	source		

[1] Connected to flange

## 3. Ordering information

Table 3: Ordering information

Type number	Package		
	Name	Description	Version
BLA1011-200	-	flanged LDMOST ceramic package; 2 mounting holes; 2 leads	SOT502A
BLA1011S-200	-	earless flanged LDMOST ceramic package; 2 leads	SOT502B

## 4. Limiting values

Table 4: Limiting values

In accordance with the Absolute Maximum Rating System (IEC 60134).

Symbol	Parameter	Conditions	Min	Max	Unit
$V_{DS}$	drain-source voltage		-	75	V
$V_{GS}$	gate-source voltage		-	±22	V
$P_{tot}$	total power dissipation	$T_h \leq 25\text{ °C}$ ; $t_p = 50\text{ }\mu\text{s}$ ; $\delta = 2\%$	-	700	W
$T_{stg}$	storage temperature		-65	+150	°C
$T_j$	junction temperature		-	200	°C

## 5. Thermal characteristics

**Table 5: Thermal characteristics**

Symbol	Parameter	Conditions	Typ	Unit
$Z_{th(j-h)}$	thermal impedance from junction to heatsink	$T_h = 25\text{ °C}$	[1] 0.15	K/W

[1] Thermal resistance is determined under RF operating conditions;  $t_p = 50\text{ }\mu\text{s}$ ,  $\delta = 10\text{ %}$ .

## 6. Characteristics

**Table 6: Characteristics**

$T_j = 25\text{ °C}$  unless otherwise specified

Symbol	Parameter	Conditions	Min	Typ	Max	Unit
$V_{(BR)DSS}$	drain-source breakdown voltage	$V_{GS} = 0\text{ V}$ ; $I_D = 3\text{ mA}$	75	-	-	V
$V_{GS(th)}$	gate-source threshold voltage	$V_{DS} = 10\text{ V}$ ; $I_D = 300\text{ mA}$	4	-	5	V
$I_{DSS}$	drain leakage current	$V_{GS} = 0\text{ V}$ ; $V_{DS} = 36\text{ V}$	-	-	1	$\mu\text{A}$
$I_{DSX}$	drain cut-off current	$V_{GS} = V_{GS(th)} + 9\text{ V}$ ; $V_{DS} = 10\text{ V}$	45	-	-	A
$I_{GSS}$	gate leakage current	$V_{GS} = \pm 20\text{ V}$ ; $V_{DS} = 0\text{ V}$	-	-	1	$\mu\text{A}$
$g_{fs}$	transfer conductance	$V_{DS} = 10\text{ V}$ ; $I_D = 10\text{ A}$	-	9	-	S
$R_{DS(on)}$	drain-source on-state resistance	$V_{GS} = 9\text{ V}$ ; $I_D = 10\text{ A}$	-	60	-	$\text{m}\Omega$

## 7. Application information

**Table 7: Application information**

RF performance in a common source pulsed class-AB circuit; ( $t_p = 50\text{ }\mu\text{s}$ ;  $\delta = 2\text{ %}$ );  $f = 1030\text{ MHz}$  and  $1090\text{ MHz}$ ;  $T_h = 25\text{ °C}$ ;  $Z_{th(mb-h)} = 0.15\text{ K/W}$ ;  $I_{Dq} = 150\text{ mA}$ ; unless otherwise specified.

Symbol	Parameter	Conditions	Min	Typ	Max	Unit
$V_{DS}$	drain-source voltage		-	36	-	V
$P_L$	load power	$t_p = 50\text{ }\mu\text{s}$ ; $\delta = 2\text{ %}$	-	200	-	W
$G_p$	power gain	$P_L = 200\text{ W}$	13	-	-	dB
$\eta_D$	drain efficiency	$t_p = 50\text{ }\mu\text{s}$ ; $\delta = 2\text{ %}$	45	-	-	%
$t_r$	rise time		-	-	50	ns
$t_f$	fall time		-	-	50	ns

### 7.1 Ruggedness in class-AB operation

The BLA1011-200 and BLA1011S-200 are capable of withstanding a load mismatch corresponding to VSWR = 5 : 1 through all phases under the following conditions:  $V_{DS} = 36\text{ V}$ ;  $f = 1030\text{ MHz}$  to  $1090\text{ MHz}$  at rated load power.

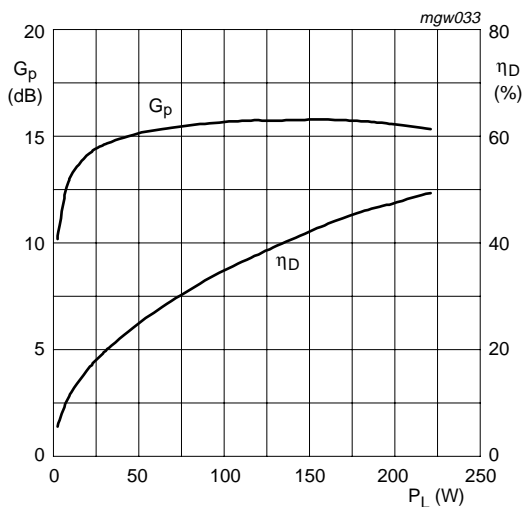

$V_{DS} = 36\text{ V}$ ;  $I_{Dq} = 150\text{ mA}$ ;  $f = 1060\text{ MHz}$ ;  $t_p = 50\text{ }\mu\text{s}$ ;  $\delta = 2\%$

Fig 1. Power gain and drain efficiency as functions of load power; typical values

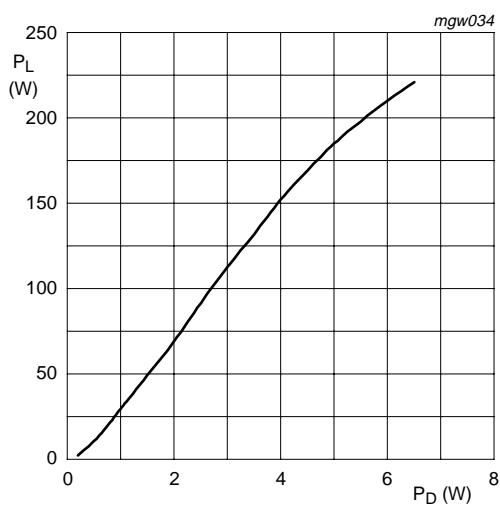

$V_{DS} = 36\text{ V}$ ;  $I_{Dq} = 150\text{ mA}$ ;  $f = 1060\text{ MHz}$ ;  $t_p = 50\text{ }\mu\text{s}$ ;  $\delta = 2\%$

Fig 2. Load power as a function of drive power; typical values

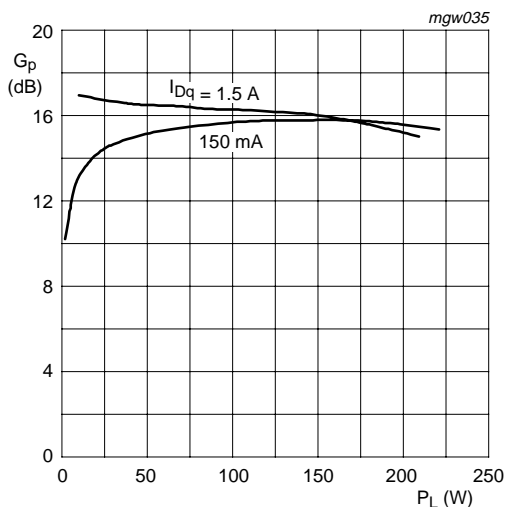

$V_{DS} = 36\text{ V}$ ;  $f = 1060\text{ MHz}$ ;  $t_p = 50\text{ }\mu\text{s}$ ;  $\delta = 2\%$

Fig 3. Power gain as a function of load power; typical values

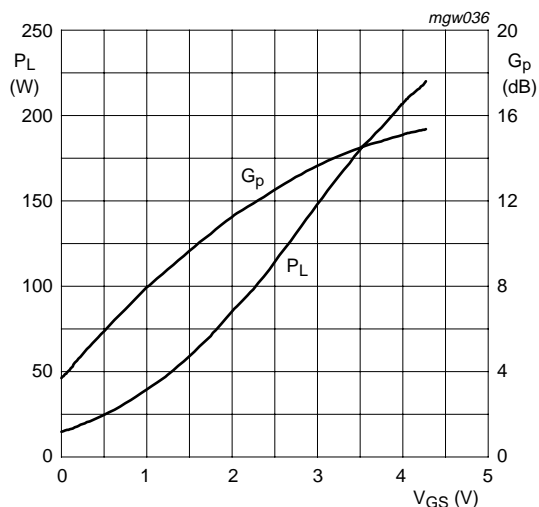

$V_{DS} = 36\text{ V}$ ;  $I_{Dq} = 150\text{ mA}$ ;  $P_i = 5.5\text{ W}$ ;  $f = 1060\text{ MHz}$ ;  $t_p = 50\text{ }\mu\text{s}$ ;  $\delta = 2\%$

Fig 4. Load power and power gain as functions of gate-source voltage; typical values

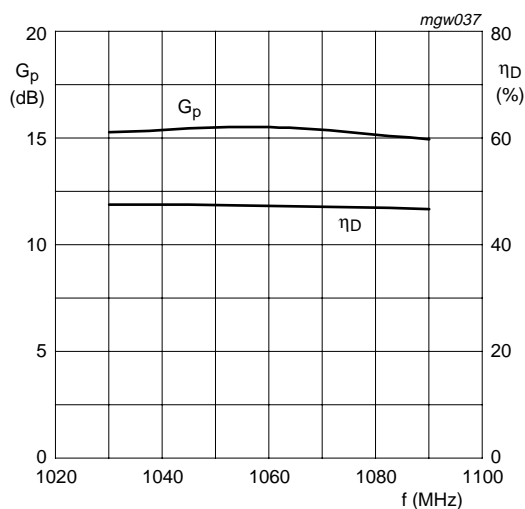

$V_{DS} = 36$  V;  $I_{Dq} = 150$  mA;  $P_L = 200$  W;  $t_p = 50$   $\mu$ s;  
 $\delta = 2$  %

Fig 5. Power gain and drain efficiency a functions of frequency; typical values

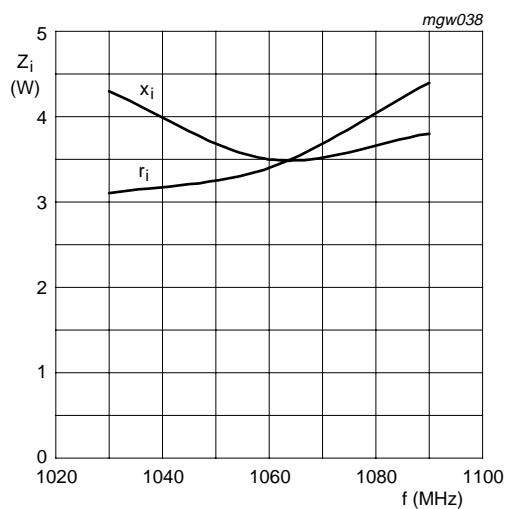

$V_{DS} = 36$  V;  $I_{Dq} = 150$  mA;  $P_L = 200$  W;  $t_p = 50$   $\mu$ s;  
 $\delta = 2$  %

Fig 6. Input Impedance as a function of frequency (series components); typical values

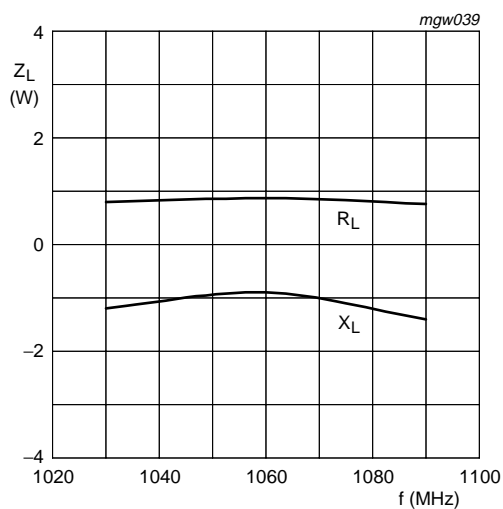

$V_{DS} = 36$  V;  $I_{Dq} = 150$  mA;  $P_L = 200$  W;  $t_p = 50$   $\mu$ s;  $\delta = 2$  %

Fig 7. Load impedance as a function of frequency (series components); typical values

## 8. Test information

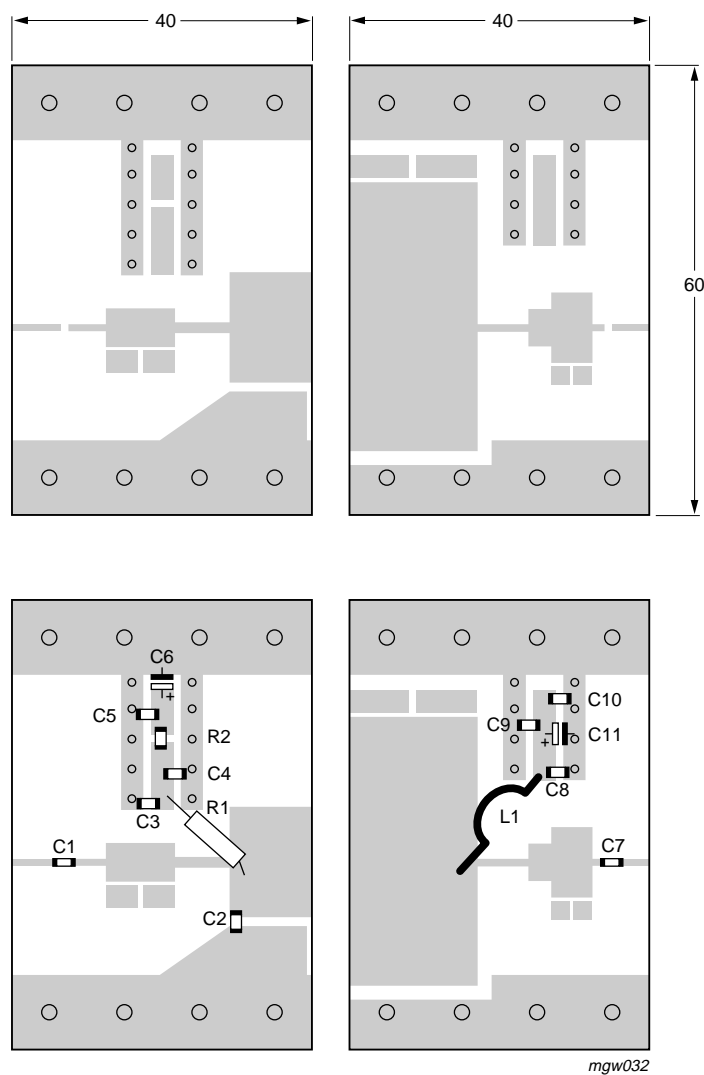

mgw032

Dimensions in mm.

The components are situated on one side of the copper-clad Duroid Printed-Circuit Board (PCB) with  $\epsilon_r = 6.2$  and thickness 0.64 mm.

The other side is unetched and serves as a ground plane.

See [Table 8](#) for list of components.

**Fig 8. Component layout for 1030 MHz to 1090 MHz test circuit**

Table 8: List of components (see Figure 8)

Component	Description	Value	Dimensions
C1	multilayer ceramic chip capacitor	[1] 39 pF	
C2	multilayer ceramic chip capacitor	[2] 4.3 pF	
C3	multilayer ceramic chip capacitor	[1] 11 pF	
C4, C7	multilayer ceramic chip capacitor	[1] 62 pF	
C5	multilayer ceramic chip capacitor	[1] 100 pF	
C6	electrolytic capacitor	47 $\mu$ F; 20 V	
C8	multilayer ceramic chip capacitor	[2] 20 pF	
C9	multilayer ceramic chip capacitor	[1] 47 pF	
C10	multilayer ceramic chip capacitor	[3] 1.2 nF	
C11	electrolytic capacitor	47 $\mu$ F; 63V	
L1	$\Omega$ -shaped enamelled 1 mm copper wire		length = 38 mm
R1	metal film resistor	301 $\Omega$	
R2	SMD 0508 resistor	18 $\Omega$	

[1] American Technical Ceramics type 100A or capacitor of same quality.

[2] American Technical Ceramics type 100B or capacitor of same quality.

[3] American Technical Ceramics type 700 or capacitor of same quality.

**9. Package outline**

Flanged LDMOST ceramic package; 2 mounting holes; 2 leads

SOT502A

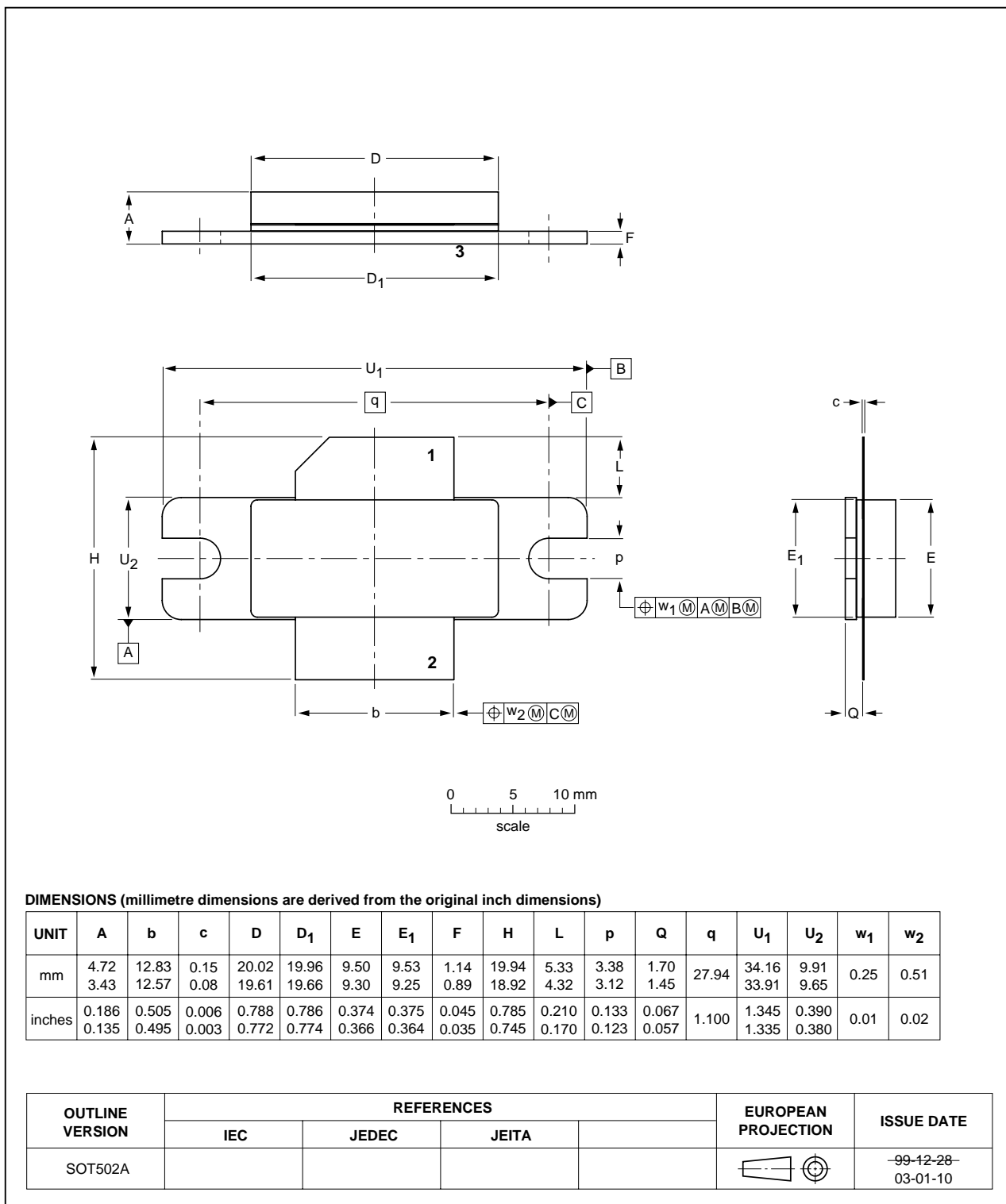

Fig 9. Package outline SOT502A



Earless flanged LDMOST ceramic package; 2 leads

SOT502B

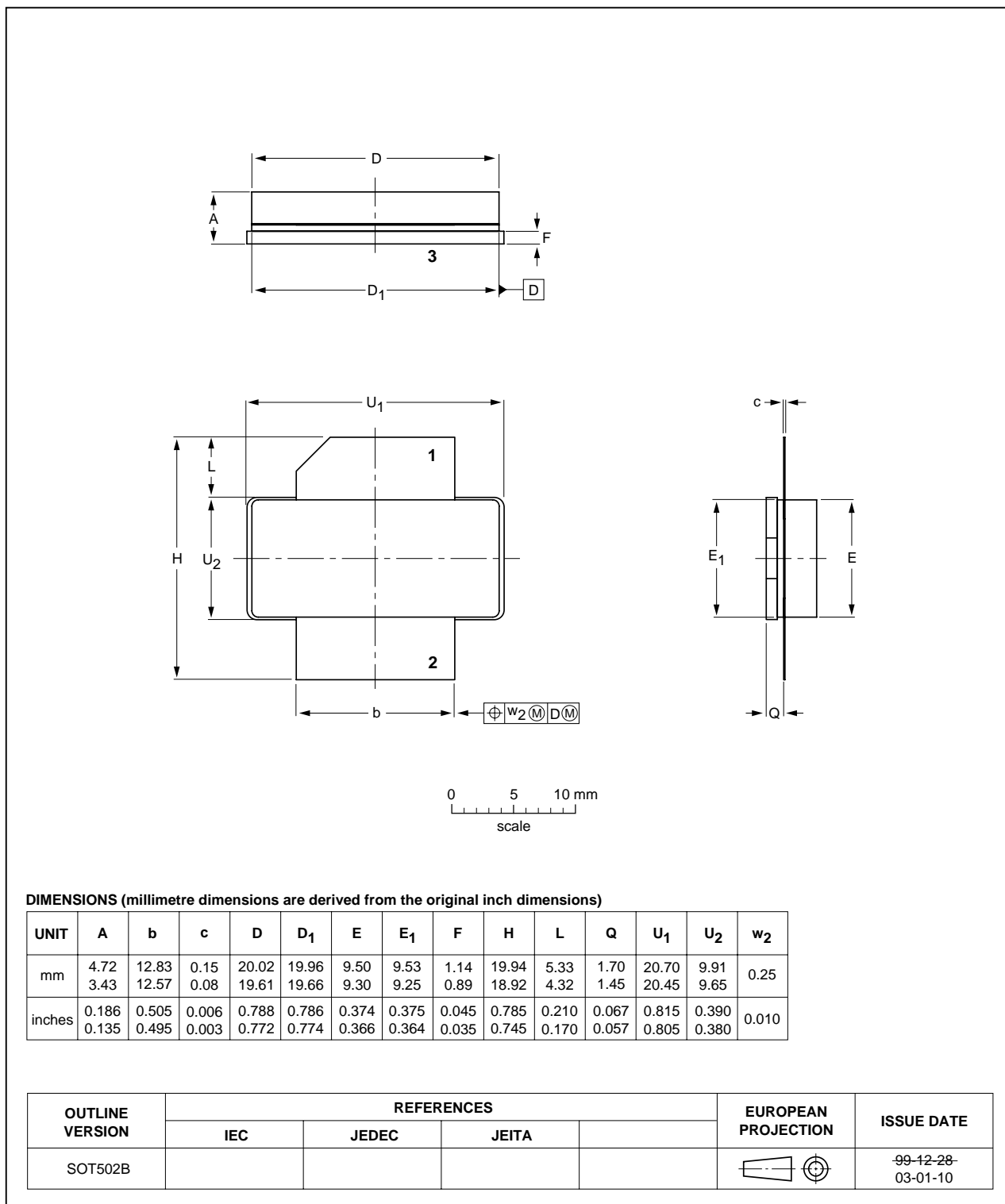

Fig 10. Package outline SOT502B

## 10. Abbreviations

**Table 9: Abbreviations**

Acronym	Description
$I_{Dq}$	quiescent drain current
LDMOS	Laterally Diffused Metal Oxide Semiconductor
RF	Radio Frequency
SMD	Surface Mount Device
VSWR	Voltage Standing Wave Ratio

## 11. Revision history

**Table 10: Revision history**

Document ID	Release date	Data sheet status	Change notice	Doc. number	Supersedes
BLA1011-200_BLA1011S-200_8	20051026	Product data sheet	-	9397 750 14634	BLA1011-200_7
Modifications:					
			<ul style="list-style-type: none"> <li>The format of this data sheet has been redesigned to comply with the new presentation and information standard of Philips Semiconductors.</li> <li>SOT502B package added.</li> </ul>		
BLA1011-200_7	20031111	Product specification	-	9397 750 12246	BLA1011-200_6
BLA1011-200_6	20020318	Product specification	-	9397 750 09414	BLA1011-200_5
BLA1011-200_5	20010515	Product specification	-	9397 750 08376	BLA1011-200_4
BLA1011-200_4	20010417	Product specification	-	9397 750 08139	BLA1011-200_N_3
BLA1011-200_N_3	20010302	Product specification	-	9397 750 08109	BLA1011-200_N_2
BLA1011-200_N_2	20001201	Product specification	-	9397 750 07638	BLA1011-200_N_1
BLA1011-200_N_1	20000906	Product specification	-	9397 750 07326	-

## 12. Data sheet status

Level	Data sheet status <sup>[1]</sup>	Product status <sup>[2] [3]</sup>	Definition
I	Objective data	Development	This data sheet contains data from the objective specification for product development. Philips Semiconductors reserves the right to change the specification in any manner without notice.
II	Preliminary data	Qualification	This data sheet contains data from the preliminary specification. Supplementary data will be published at a later date. Philips Semiconductors reserves the right to change the specification without notice, in order to improve the design and supply the best possible product.
III	Product data	Production	This data sheet contains data from the product specification. Philips Semiconductors reserves the right to make changes at any time in order to improve the design, manufacturing and supply. Relevant changes will be communicated via a Customer Product/Process Change Notification (CPCN).

[1] Please consult the most recently issued data sheet before initiating or completing a design.

[2] The product status of the device(s) described in this data sheet may have changed since this data sheet was published. The latest information is available on the Internet at URL <http://www.semiconductors.philips.com>.

[3] For data sheets describing multiple type numbers, the highest-level product status determines the data sheet status.

## 13. Definitions

**Short-form specification** — The data in a short-form specification is extracted from a full data sheet with the same type number and title. For detailed information see the relevant data sheet or data handbook.

**Limiting values definition** — Limiting values given are in accordance with the Absolute Maximum Rating System (IEC 60134). Stress above one or more of the limiting values may cause permanent damage to the device. These are stress ratings only and operation of the device at these or at any other conditions above those given in the Characteristics sections of the specification is not implied. Exposure to limiting values for extended periods may affect device reliability.

**Application information** — Applications that are described herein for any of these products are for illustrative purposes only. Philips Semiconductors make no representation or warranty that such applications will be suitable for the specified use without further testing or modification.

## 14. Disclaimers

**Life support** — These products are not designed for use in life support appliances, devices, or systems where malfunction of these products can reasonably be expected to result in personal injury. Philips Semiconductors

## 16. Contact information

For additional information, please visit: <http://www.semiconductors.philips.com>

For sales office addresses, send an email to: [sales.addresses@www.semiconductors.philips.com](mailto:sales.addresses@www.semiconductors.philips.com)

customers using or selling these products for use in such applications do so at their own risk and agree to fully indemnify Philips Semiconductors for any damages resulting from such application.

**Right to make changes** — Philips Semiconductors reserves the right to make changes in the products - including circuits, standard cells, and/or software - described or contained herein in order to improve design and/or performance. When the product is in full production (status 'Production'), relevant changes will be communicated via a Customer Product/Process Change Notification (CPCN). Philips Semiconductors assumes no responsibility or liability for the use of any of these products, conveys no license or title under any patent, copyright, or mask work right to these products, and makes no representations or warranties that these products are free from patent, copyright, or mask work right infringement, unless otherwise specified.

## 15. Trademarks

**Notice** — All referenced brands, product names, service names and trademarks are the property of their respective owners.

## 17. Contents

<b>1</b>	<b>Product profile</b> .....	<b>1</b>
1.1	General description .....	1
1.2	Features .....	1
1.3	Applications .....	1
<b>2</b>	<b>Pinning information</b> .....	<b>2</b>
<b>3</b>	<b>Ordering information</b> .....	<b>2</b>
<b>4</b>	<b>Limiting values</b> .....	<b>2</b>
<b>5</b>	<b>Thermal characteristics</b> .....	<b>3</b>
<b>6</b>	<b>Characteristics</b> .....	<b>3</b>
<b>7</b>	<b>Application information</b> .....	<b>3</b>
7.1	Ruggedness in class-AB operation .....	3
<b>8</b>	<b>Test information</b> .....	<b>6</b>
<b>9</b>	<b>Package outline</b> .....	<b>8</b>
<b>10</b>	<b>Abbreviations</b> .....	<b>10</b>
<b>11</b>	<b>Revision history</b> .....	<b>11</b>
<b>12</b>	<b>Data sheet status</b> .....	<b>12</b>
<b>13</b>	<b>Definitions</b> .....	<b>12</b>
<b>14</b>	<b>Disclaimers</b> .....	<b>12</b>
<b>15</b>	<b>Trademarks</b> .....	<b>12</b>
<b>16</b>	<b>Contact information</b> .....	<b>12</b>



© Koninklijke Philips Electronics N.V. 2005

All rights are reserved. Reproduction in whole or in part is prohibited without the prior written consent of the copyright owner. The information presented in this document does not form part of any quotation or contract, is believed to be accurate and reliable and may be changed without notice. No liability will be accepted by the publisher for any consequence of its use. Publication thereof does not convey nor imply any license under patent- or other industrial or intellectual property rights.

Date of release: 26 October 2005  
Document number: 9397 750 14634

Published in The Netherlands