

# DATA SHEET

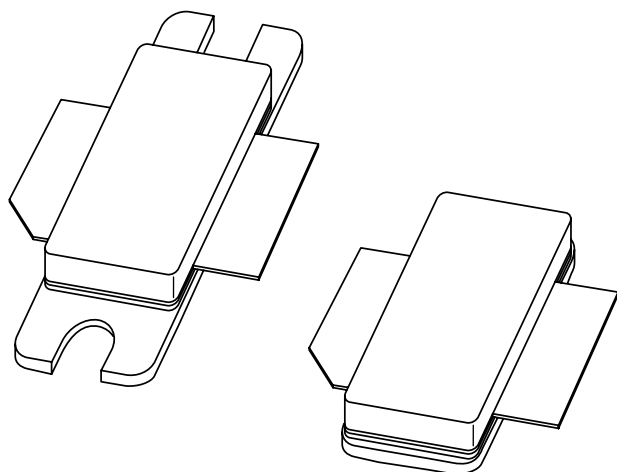

## **BLF0810-90; BLF0810S-90** Base station LDMOS transistors

Product specification  
Supersedes data of 2003 May 09

2003 Jun 12

## Base station LDMOS transistors

## BLF0810-90; BLF0810S-90

## FEATURES

- Typical CDMA IS95 performance at standard settings with a supply voltage of 27 V and  $I_{DQ}$  of 560 mA. Adjacent channel bandwidth is 30 kHz, adjacent channel at  $\pm 750$  kHz:
  - Output power = 15 W (AV)
  - Gain = 16 dB
  - Efficiency = 27%
  - ACPR =  $-46$  dBc at 750 kHz and BW = 30 kHz
- 70 W CW performance
- Easy power control
- Excellent ruggedness
- High power gain
- Excellent thermal stability
- Designed for broadband operation (800 to 1000 MHz)
- Internally matched for ease of use.

## APPLICATIONS

- RF power amplifier for GSM, EDGE and CDMA base stations and multicarrier operations in the 800 to 1000 MHz frequency range.

## DESCRIPTION

90 W LDMOS power transistor for base station applications at frequencies from 800 to 1000 MHz.

## PINNING - SOT502A

| PIN | DESCRIPTION                 |
|-----|-----------------------------|
| 1   | drain                       |
| 2   | gate                        |
| 3   | source; connected to flange |

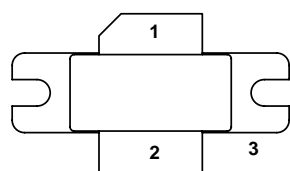

Top view

MBK394

Fig.1 Simplified outline SOT502A (BLF0810-90).

## PINNING - SOT502B

| PIN | DESCRIPTION                 |
|-----|-----------------------------|
| 1   | drain                       |
| 2   | gate                        |
| 3   | source; connected to flange |

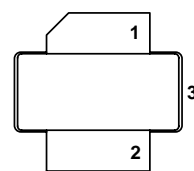

Top view

MBL105

Fig.2 Simplified outline SOT502B (BLF0810S-90)

## QUICK REFERENCE DATA

Typical RF performance at  $T_h = 25$  °C in a common source test circuit.

| MODE OF OPERATION | f (MHz)                       | $V_{DS}$ (V) | $P_L$ (W) | $G_p$ (dB) | $\eta_D$ (%) | $d_3$ (dBc) | ACPR 750 (dBc) |
|-------------------|-------------------------------|--------------|-----------|------------|--------------|-------------|----------------|
| Class-AB (2-tone) | $f_1 = 890.0$ ; $f_2 = 890.1$ | 27           | 70 (PEP)  | 16         | 39           | $-28$       | –              |
| CDMA (IS95)       | 890                           | 27           | 15 (AV)   | 16         | 27           | –           | $-46$          |

## Base station LDMOS transistors

## BLF0810-90; BLF0810S-90

**LIMITING VALUES**

In accordance with the Absolute Maximum Rating System (IEC 60134).

| SYMBOL    | PARAMETER            | MIN. | MAX. | UNIT |
|-----------|----------------------|------|------|------|
| $V_{DS}$  | drain-source voltage | –    | 75   | V    |
| $V_{GS}$  | gate-source voltage  | –    | ±15  | V    |
| $T_{stg}$ | storage temperature  | –65  | 150  | °C   |
| $T_j$     | junction temperature | –    | 200  | °C   |

**THERMAL CHARACTERISTICS**

| SYMBOL         | PARAMETER                                    | CONDITIONS   | VALUE | UNIT |
|----------------|--|--|-------|------|
| $R_{th\ j-c}$  | thermal resistance from junction to case     | $T_h = 25\text{ °C}$ , $P_L = 35\text{ W (AV)}$ , note 1 | 1     | K/W  |
| $R_{th\ j-hs}$ | thermal resistance from heatsink to junction | $T_h = 25\text{ °C}$ , $P_L = 35\text{ W (AV)}$ , note 2 | 1.3   | K/W  |

**Notes**

1. Thermal resistance is determined under RF operating conditions.
2. Depending on mounting condition in application.

**CHARACTERISTICS**

$T_j = 25\text{ °C}$  unless otherwise specified.

| SYMBOL        | PARAMETER                        | CONDITIONS  | MIN. | TYP. | MAX. | UNIT |
|---------------|----------------------------------|---|------|------|------|------|
| $V_{(BR)DSS}$ | drain-source breakdown voltage   | $V_{GS} = 0$ ; $I_D = 3\text{ mA}$                        | 75   | –    | –    | V    |
| $V_{GSth}$    | gate-source threshold voltage    | $V_{DS} = 10\text{ V}$ ; $I_D = 300\text{ mA}$            | 4    | –    | 5    | V    |
| $I_{DSS}$     | drain-source leakage current     | $V_{GS} = 0$ ; $V_{DS} = 36\text{ V}$                     | –    | –    | 1.5  | μA   |
| $I_{DSX}$     | on-state drain current           | $V_{GS} = V_{GSth} + 9\text{ V}$ ; $V_{DS} = 10\text{ V}$ | 24   | –    | –    | A    |
| $I_{GSS}$     | gate leakage current             | $V_{GS} = \pm 20\text{ V}$ ; $V_{DS} = 0$                 | –    | –    | 0.5  | μA   |
| $g_{fs}$      | forward transconductance         | $V_{DS} = 10\text{ V}$ ; $I_D = 10\text{ A}$              | –    | 4.4  | –    | S    |
| $R_{DSon}$    | drain-source on-state resistance | $V_{GS} = 9\text{ V}$ ; $I_D = 10\text{ A}$               | –    | 120  | –    | mΩ   |

Base station LDMOS transistors

BLF0810-90; BLF0810S-90

APPLICATION INFORMATION

RF performance in a common source class-AB circuit.

$V_{DS} = 27\text{ V}$ ;  $I_{DQ} = 560\text{ mA}$ ;  $f = 890\text{ MHz}$ ;  $T_h = 25\text{ }^\circ\text{C}$ ; unless otherwise specified.

| SYMBOL   | PARAMETER                              | CONDITIONS   | MIN.                           | TYP. | MAX. | UNIT |
|--|--|--|--------------------------------|------|------|------|
| <b>Mode of operation: 2-tone CW, 100 kHz spacing</b>                                 |  |  |                                |      |      |      |
| $G_p$  | gain power                             | $P_L = 45\text{ W (PEP)}$                                    | 15                             | 16.5 | –    | dB   |
| $\eta_D$   | drain efficiency                       |  | 29                             | 32   | –    | %    |
| IRL  | input return loss                      |  | –                              | –10  | –6   | dB   |
| $d_3$  | third order intermodulation distortion |  | –                              | –40  | –    | dBc  |
| $G_p$  | gain power                             | $P_L = 63\text{ W (PEP)}$                                    | –                              | 16.5 | –    | dB   |
| $\eta_D$   | drain efficiency                       |  | 33                             | 38   | –    | %    |
| $d_3$  | third order intermodulation distortion |  | –                              | –32  | –27  | dBc  |
|  | ruggedness                             | VSWR = 10 : 1 through all phases; $P_L = 125\text{ W (PEP)}$ | no degradation in output power |      |      |      |
| <b>Mode of operation: CDMA, IS95 (pilot, paging, sync and traffic codes 8 to 13)</b> |  |  |                                |      |      |      |
| $G_p$  | gain power                             | $P_L = 15\text{ W (AV)}$                                     | –                              | 16   | –    | dB   |
| $\eta_D$   | drain efficiency                       | $P_L = 15\text{ W (AV)}$                                     | –                              | 27   | –    | %    |
| ACPR 750   | adjacent channel power ratio           | at BW = 30 kHz   | –                              | –46  | –    | dBc  |

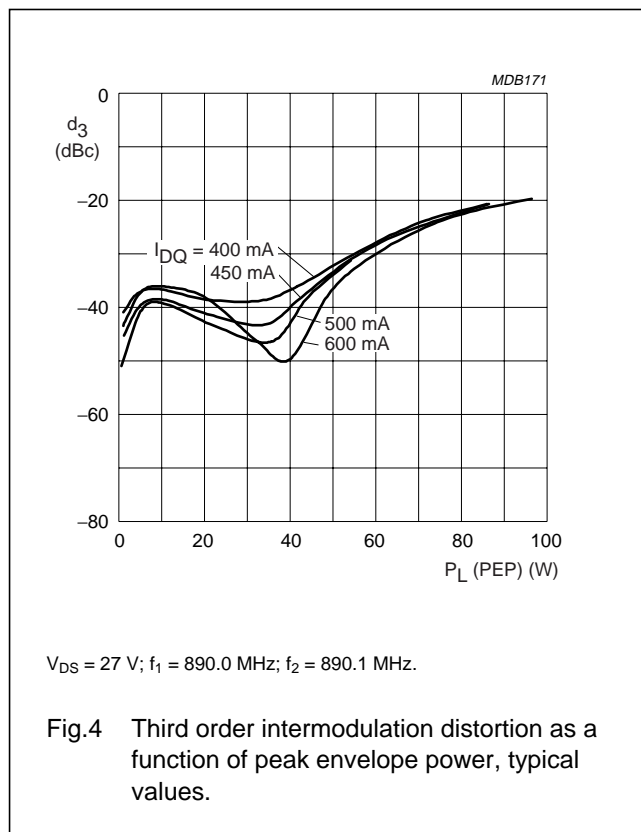
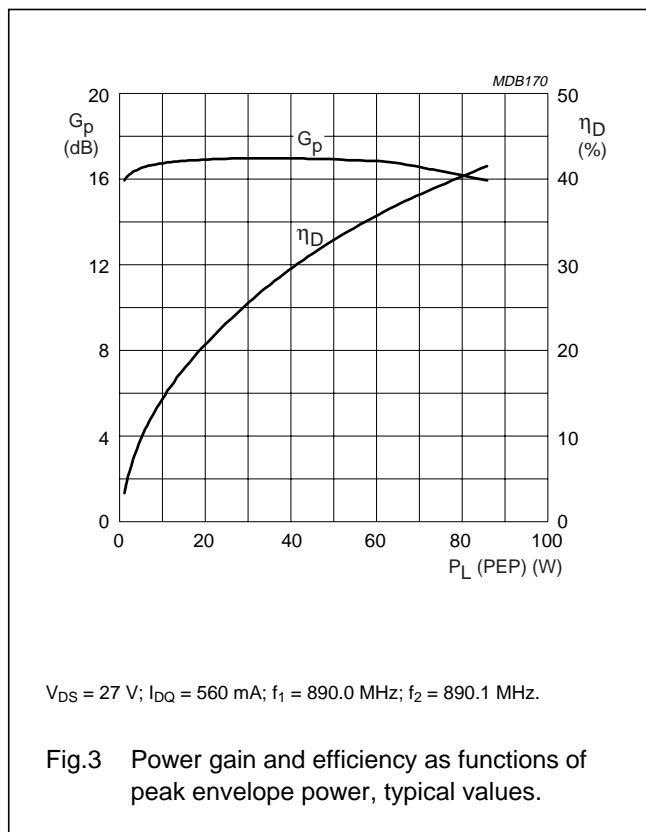

Base station LDMOS transistors

BLF0810-90; BLF0810S-90

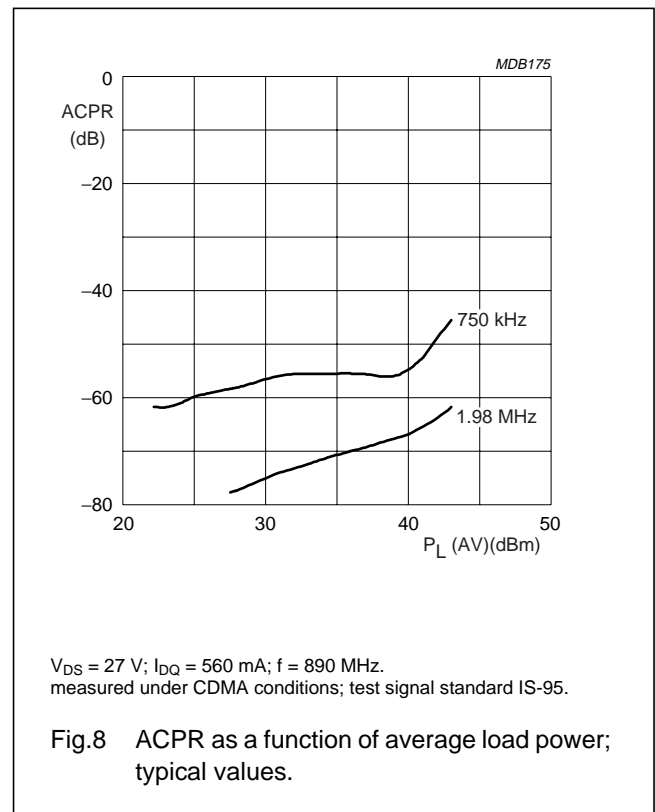
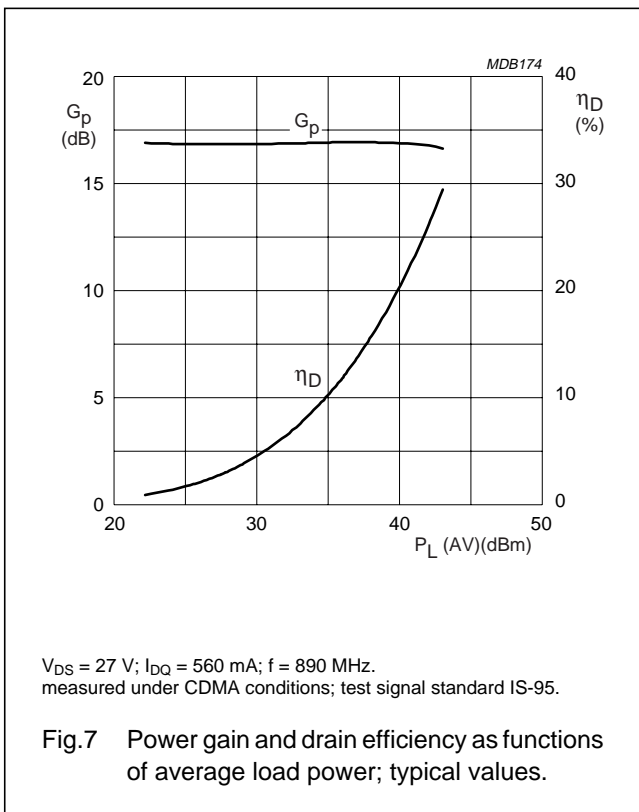
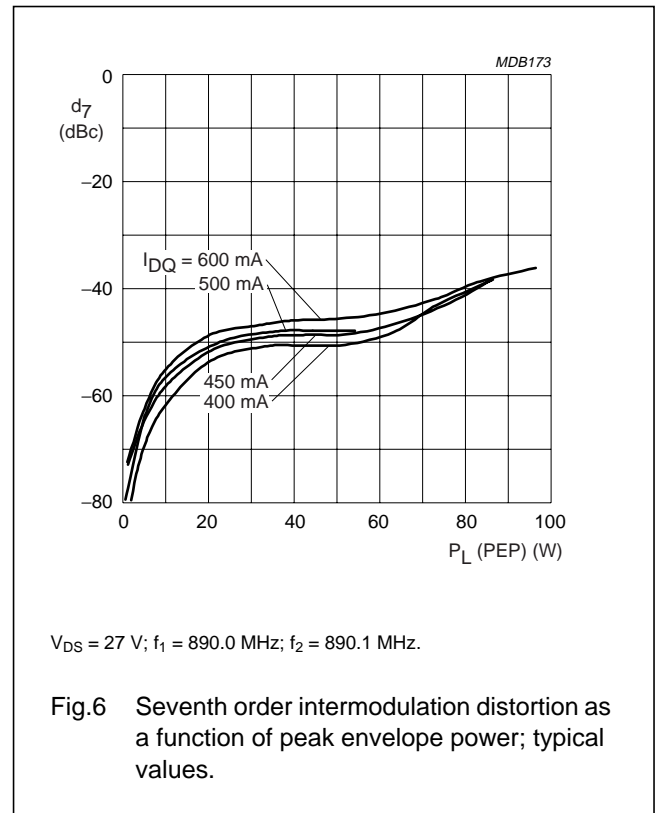
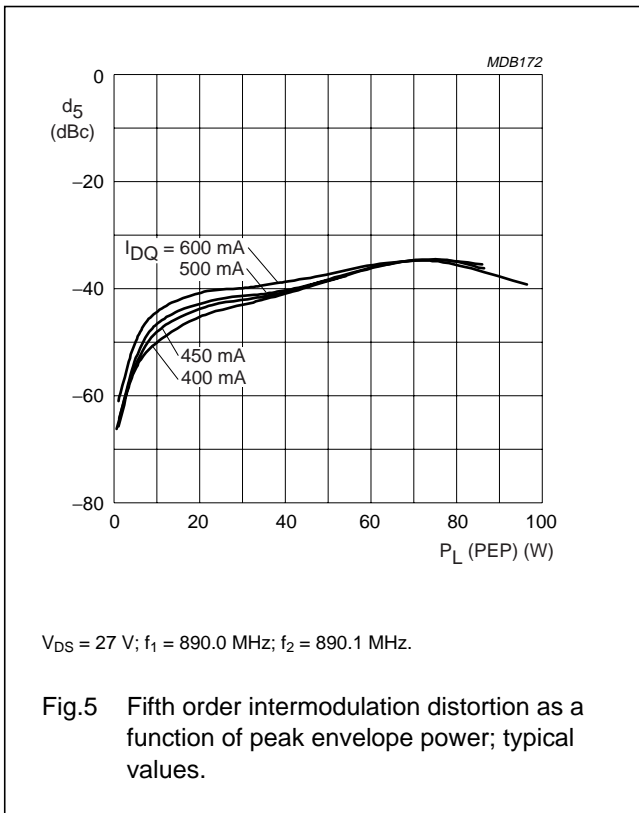

Base station LDMOS transistors

BLF0810-90; BLF0810S-90

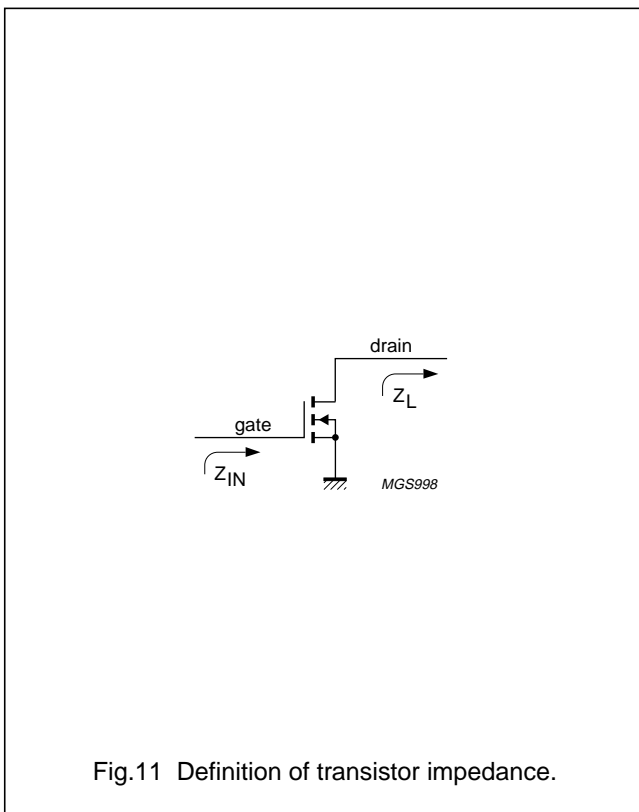
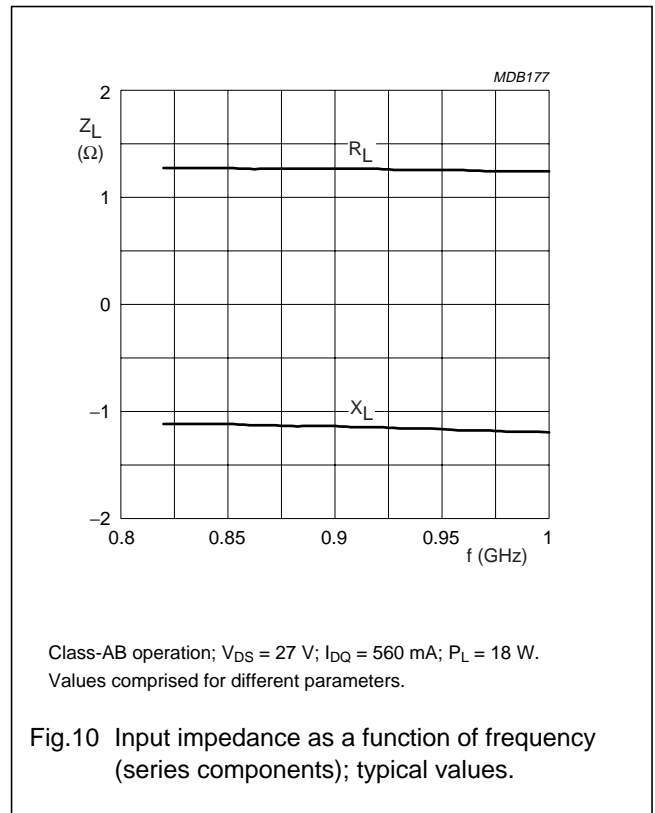
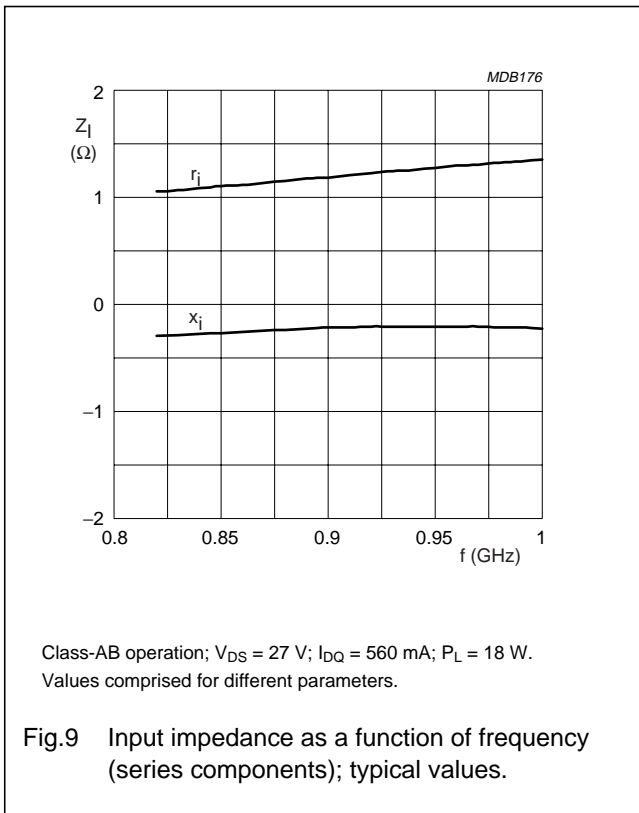

## Base station LDMOS transistors

## BLF0810-90; BLF0810S-90

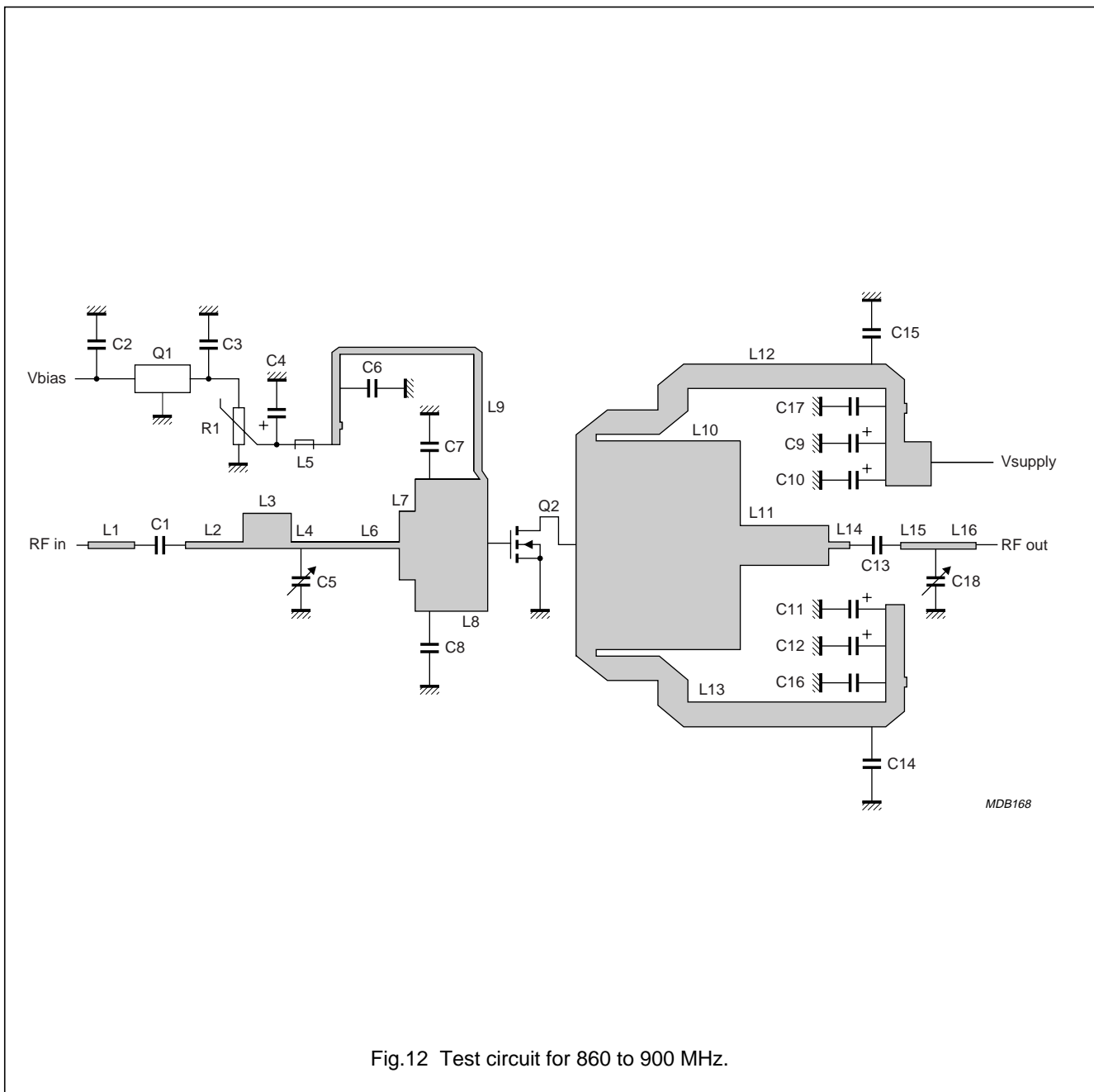
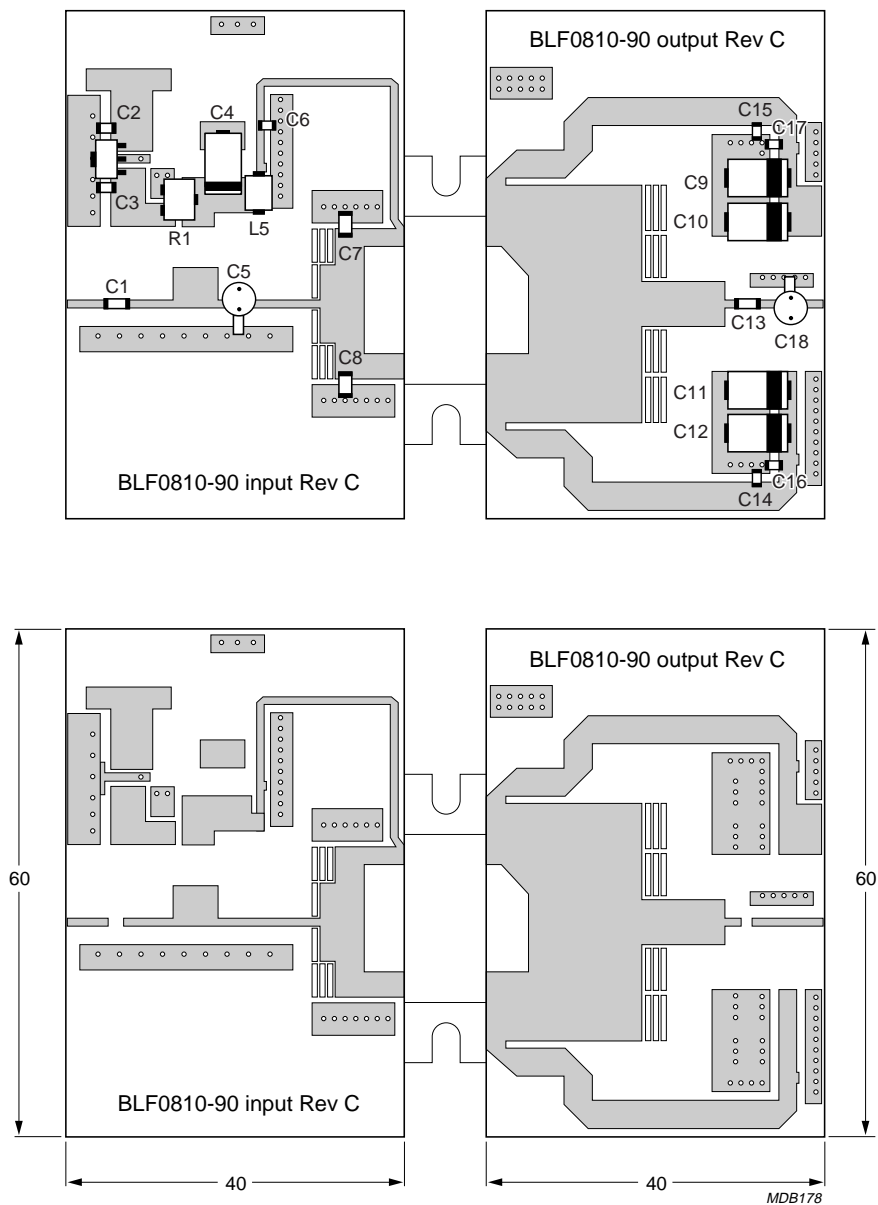

Fig.12 Test circuit for 860 to 900 MHz.

Base station LDMOS transistors

BLF0810-90; BLF0810S-90



Dimensions in mm.

The components are situated on one side of the copper-clad Rogers 6006 printed-circuit board ( $\epsilon_r = 6.15$ ); thickness = 25 mm. The other side is unetched and serves as a ground plane.

Fig.13 Component layout for 860 to 900 MHz test circuit.



## Base station LDMOS transistors

## BLF0810-90; BLF0810S-90

## List of components (see Figs 12 and 13)

| COMPONENT                       | DESCRIPTION                               | VALUE        | DIMENSIONS             |
|---------------------------------|---|--------------|------------------------|
| C1, C6, C13, C14, C15, C16, C17 | multilayer ceramic chip capacitor; note 1 | 68 pF        |                        |
| C2                              | multilayer ceramic chip capacitor; note 1 | 330 nF       |                        |
| C3                              | multilayer ceramic chip capacitor; note 1 | 100 nF       |                        |
| C4, C9, C10, C11, C12           | tantalum capacitor                        | 10 $\mu$ F   |                        |
| C5, C18                         | air trimmer capacitor                     | 8 pF         |                        |
| C7, C8                          | multilayer ceramic chip capacitor         | 8.2 pF       |                        |
| R1                              | potentiometer                             | 1 k $\Omega$ |                        |
| Q1                              | 7808 voltage regulator                    |              |                        |
| Q2                              | BLF0810-90/BLF0810S-90 LDMOS transistor   |              |                        |
| L1                              | stripline; note 2                         |              | 5.22 $\times$ 0.92 mm  |
| L2                              | stripline; note 2                         |              | 6.47 $\times$ 0.92 mm  |
| L3                              | stripline; note 2                         |              | 5.38 $\times$ 4.8 mm   |
| L4                              | stripline; note 2                         |              | 2.4 $\times$ 0.92 mm   |
| L5                              | ferroxcube                                |              |                        |
| L6                              | stripline; note 2                         |              | 9.73 $\times$ 0.92 mm  |
| L7                              | stripline; note 2                         |              | 1.82 $\times$ 9.3 mm   |
| L8                              | stripline; note 2                         |              | 8.15 $\times$ 17.9 mm  |
| L9                              | stripline; note 2                         |              | 44 $\times$ 0.92 mm    |
| L10                             | stripline; note 2                         |              | 18.45 $\times$ 28.3 mm |
| L11                             | stripline; note 2                         |              | 9.95 $\times$ 5.38 mm  |
| L12, L13                        | stripline; note 2                         |              | 37.6 $\times$ 3.35 mm  |
| L14                             | stripline; note 2                         |              | 2.36 $\times$ 0.92 mm  |
| L15, L16                        | stripline; note 2                         |              | 4.22 $\times$ 0.92 mm  |

## Notes

1. American Technical Ceramics type 100A or capacitor of same quality.
2. The striplines are on a double copper-clad Rogers 6006 printed-circuit board ( $\epsilon_r = 6.15$ ); thickness = 0.64 mm.

Base station LDMOS transistors

BLF0810-90; BLF0810S-90

PACKAGE OUTLINES

Flanged LDMOST ceramic package; 2 mounting holes; 2 leads

SOT502A

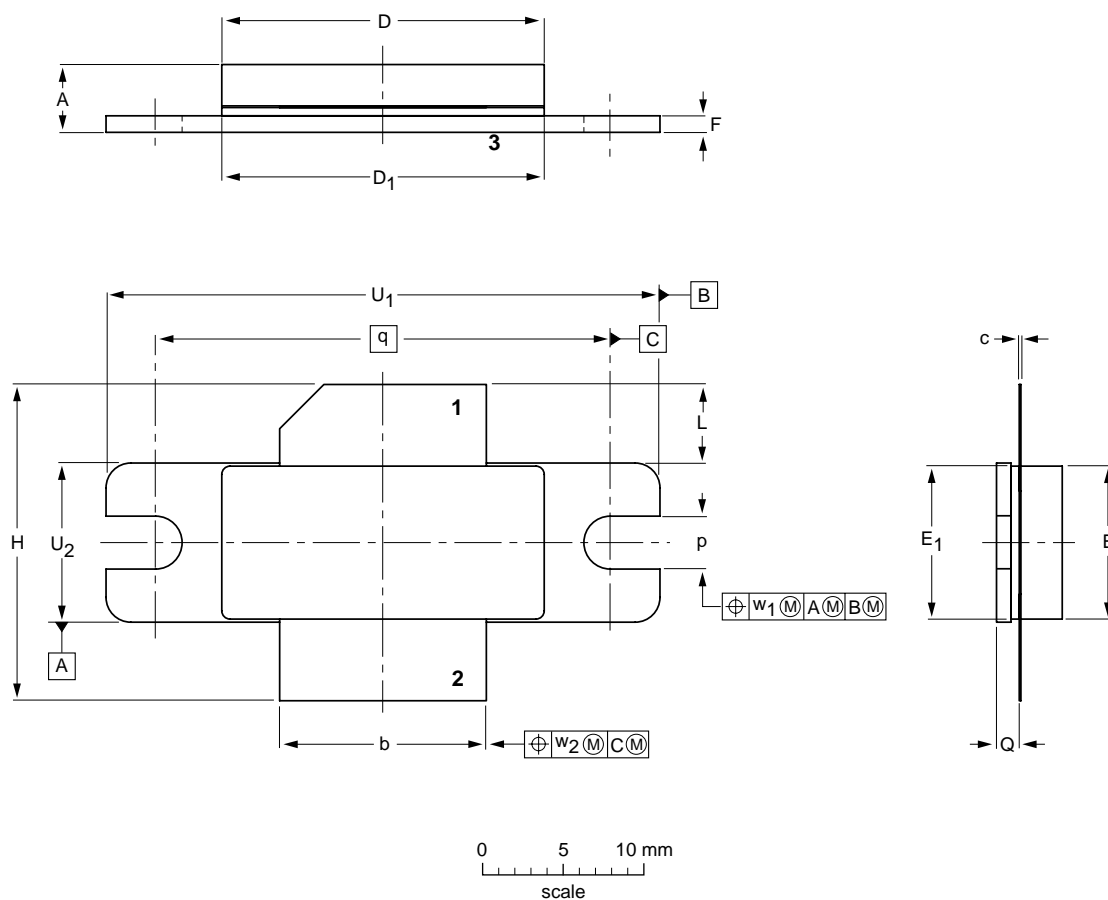

DIMENSIONS (millimetre dimensions are derived from the original inch dimensions)

| UNIT   | A              | b              | c              | D              | D <sub>1</sub> | E              | E <sub>1</sub> | F              | H              | L              | p              | Q              | q     | U <sub>1</sub> | U <sub>2</sub> | w <sub>1</sub> | w <sub>2</sub> |
|--------|----------------|----------------|----------------|----------------|----------------|----------------|----------------|----------------|----------------|----------------|----------------|----------------|-------|----------------|----------------|----------------|----------------|
| mm     | 4.72<br>3.43   | 12.83<br>12.57 | 0.15<br>0.08   | 20.02<br>19.61 | 19.96<br>19.66 | 9.50<br>9.30   | 9.53<br>9.25   | 1.14<br>0.89   | 19.94<br>18.92 | 5.33<br>4.32   | 3.38<br>3.12   | 1.70<br>1.45   | 27.94 | 34.16<br>33.91 | 9.91<br>9.65   | 0.25           | 0.51           |
| inches | 0.186<br>0.135 | 0.505<br>0.495 | 0.006<br>0.003 | 0.788<br>0.772 | 0.786<br>0.774 | 0.374<br>0.366 | 0.375<br>0.364 | 0.045<br>0.035 | 0.785<br>0.745 | 0.210<br>0.170 | 0.133<br>0.123 | 0.067<br>0.057 | 1.100 | 1.345<br>1.335 | 0.390<br>0.380 | 0.01           | 0.02           |

| OUTLINE VERSION | REFERENCES |       |       |  | EUROPEAN PROJECTION | ISSUE DATE           |
|-----------------|------------|-------|-------|--|---------------------|----------------------|
|                 | IEC        | JEDEC | JEITA |  |                     |                      |
| SOT502A         |            |       |       |  |                     | 99-12-28<br>03-01-10 |

Base station LDMOS transistors

BLF0810-90; BLF0810S-90

Earless flanged LDMOST ceramic package; 2 leads

SOT502B

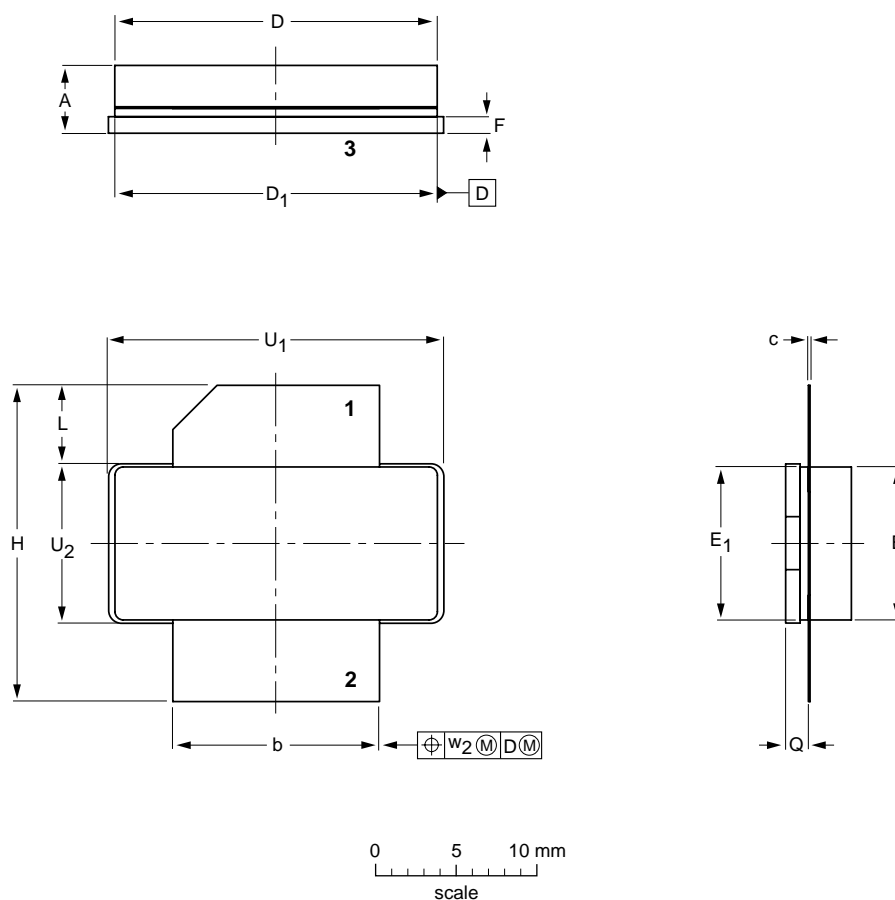

DIMENSIONS (millimetre dimensions are derived from the original inch dimensions)

| UNIT   | A              | b              | c              | D              | D <sub>1</sub> | E              | E <sub>1</sub> | F              | H              | L              | Q              | U <sub>1</sub> | U <sub>2</sub> | w <sub>2</sub> |
|--------|----------------|----------------|----------------|----------------|----------------|----------------|----------------|----------------|----------------|----------------|----------------|----------------|----------------|----------------|
| mm     | 4.72<br>3.43   | 12.83<br>12.57 | 0.15<br>0.08   | 20.02<br>19.61 | 19.96<br>19.66 | 9.50<br>9.30   | 9.53<br>9.25   | 1.14<br>0.89   | 19.94<br>18.92 | 5.33<br>4.32   | 1.70<br>1.45   | 20.70<br>20.45 | 9.91<br>9.65   | 0.25           |
| inches | 0.186<br>0.135 | 0.505<br>0.495 | 0.006<br>0.003 | 0.788<br>0.772 | 0.786<br>0.774 | 0.374<br>0.366 | 0.375<br>0.364 | 0.045<br>0.035 | 0.785<br>0.745 | 0.210<br>0.170 | 0.067<br>0.057 | 0.815<br>0.805 | 0.390<br>0.380 | 0.010          |

| OUTLINE VERSION | REFERENCES |       |       |  | EUROPEAN PROJECTION | ISSUE DATE            |
|-----------------|------------|-------|-------|--|---------------------|-----------------------|
|                 | IEC        | JEDEC | JEITA |  |                     |                       |
| SOT502B         |            |       |       |  |                     | 99-12-28-<br>03-01-10 |

## Base station LDMOS transistors

## BLF0810-90; BLF0810S-90

## DATA SHEET STATUS

| LEVEL | DATA SHEET STATUS <sup>(1)</sup> | PRODUCT STATUS <sup>(2)(3)</sup> | DEFINITION   |
|-------|----------------------------------|----------------------------------|--|
| I     | Objective data                   | Development                      | This data sheet contains data from the objective specification for product development. Philips Semiconductors reserves the right to change the specification in any manner without notice.  |
| II    | Preliminary data                 | Qualification                    | This data sheet contains data from the preliminary specification. Supplementary data will be published at a later date. Philips Semiconductors reserves the right to change the specification without notice, in order to improve the design and supply the best possible product.             |
| III   | Product data                     | Production                       | This data sheet contains data from the product specification. Philips Semiconductors reserves the right to make changes at any time in order to improve the design, manufacturing and supply. Relevant changes will be communicated via a Customer Product/Process Change Notification (CPCN). |

## Notes

1. Please consult the most recently issued data sheet before initiating or completing a design.
2. The product status of the device(s) described in this data sheet may have changed since this data sheet was published. The latest information is available on the Internet at URL <http://www.semiconductors.philips.com>.
3. For data sheets describing multiple type numbers, the highest-level product status determines the data sheet status.

## DEFINITIONS

**Short-form specification** — The data in a short-form specification is extracted from a full data sheet with the same type number and title. For detailed information see the relevant data sheet or data handbook.

**Limiting values definition** — Limiting values given are in accordance with the Absolute Maximum Rating System (IEC 60134). Stress above one or more of the limiting values may cause permanent damage to the device. These are stress ratings only and operation of the device at these or at any other conditions above those given in the Characteristics sections of the specification is not implied. Exposure to limiting values for extended periods may affect device reliability.

**Application information** — Applications that are described herein for any of these products are for illustrative purposes only. Philips Semiconductors make no representation or warranty that such applications will be suitable for the specified use without further testing or modification.

## DISCLAIMERS

**Life support applications** — These products are not designed for use in life support appliances, devices, or systems where malfunction of these products can reasonably be expected to result in personal injury. Philips Semiconductors customers using or selling these products for use in such applications do so at their own risk and agree to fully indemnify Philips Semiconductors for any damages resulting from such application.

**Right to make changes** — Philips Semiconductors reserves the right to make changes in the products - including circuits, standard cells, and/or software - described or contained herein in order to improve design and/or performance. When the product is in full production (status 'Production'), relevant changes will be communicated via a Customer Product/Process Change Notification (CPCN). Philips Semiconductors assumes no responsibility or liability for the use of any of these products, conveys no licence or title under any patent, copyright, or mask work right to these products, and makes no representations or warranties that these products are free from patent, copyright, or mask work right infringement, unless otherwise specified.

Base station LDMOS transistors

BLF0810-90; BLF0810S-90

---

**NOTES**

Base station LDMOS transistors

BLF0810-90; BLF0810S-90

---

**NOTES**

Base station LDMOS transistors

BLF0810-90; BLF0810S-90

---

**NOTES**

# ***Philips Semiconductors – a worldwide company***

## **Contact information**

For additional information please visit <http://www.semiconductors.philips.com>. Fax: +31 40 27 24825

For sales offices addresses send e-mail to: [sales.addresses@www.semiconductors.philips.com](mailto:sales.addresses@www.semiconductors.philips.com).

© Koninklijke Philips Electronics N.V. 2003

SCA75

All rights are reserved. Reproduction in whole or in part is prohibited without the prior written consent of the copyright owner.

The information presented in this document does not form part of any quotation or contract, is believed to be accurate and reliable and may be changed without notice. No liability will be accepted by the publisher for any consequence of its use. Publication thereof does not convey nor imply any license under patent- or other industrial or intellectual property rights.

Printed in The Netherlands

613524/03/pp16

Date of release: 2003 Jun 12

Document order number: 9397 750 11544

*Let's make things better.*

**Philips  
Semiconductors**



**PHILIPS**  
www.DataSheet4U.com