

# DATA SHEET

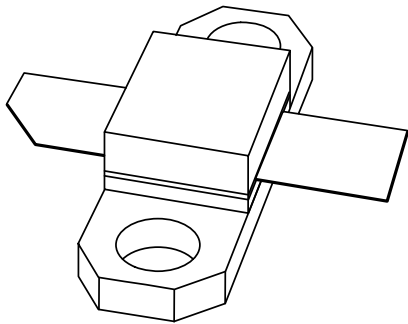

## **BLF2043F** UHF power LDMOS transistor

Product specification  
Supersedes data of 2000 Oct 19

2002 Mar 05

# UHF power LDMOS transistor

# BLF2043F

### FEATURES

- High power gain
- Easy power control
- Excellent ruggedness
- Source on mounting base eliminates DC isolators, reducing common mode inductance
- Designed for broadband operation (HF to 2.2 GHz).

### APPLICATIONS

- Communication transmitter applications in the UHF frequency range.

### DESCRIPTION

Silicon N-channel enhancement mode lateral D-MOS transistor encapsulated in a 2-lead flange package (SOT467C) with a ceramic cap. The common source is connected to the mounting flange.

### PINNING - SOT467C

PIN	DESCRIPTION
1	drain
2	gate
3	source, connected to flange

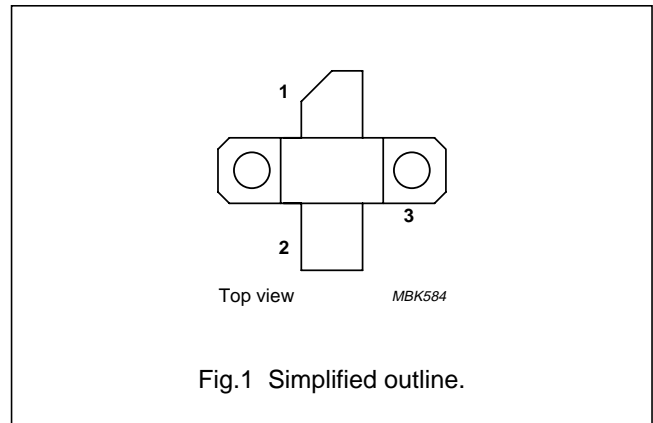

### QUICK REFERENCE DATA

RF performance at  $T_h = 25\text{ °C}$  in a common source test circuit.

MODE OF OPERATION	f (MHz)	$V_{DS}$ (V)	$P_L$ (W)	$G_p$ (dB)	$\eta_D$ (%)	$d_{im}$ (dBc)
CW, class-AB (2-tone)	$f_1 = 2200; f_2 = 2200.1$	26	10 (PEP)	>11	>30	$\leq -26$

### LIMITING VALUES

In accordance with the Absolute Maximum Rating System (IEC 60134).

SYMBOL	PARAMETER	MIN.	MAX.	UNIT
$V_{DS}$	drain-source voltage	–	65	V
$V_{GS}$	gate-source voltage	–	$\pm 15$	V
$I_D$	drain current (DC)	–	2.2	A
$T_{stg}$	storage temperature	–65	+150	°C
$T_j$	junction temperature	–	200	°C

CAUTION	
This product is supplied in anti-static packing to prevent damage caused by electrostatic discharge during transport and handling. For further information, refer to Philips specs.: SNW-EQ-608, SNW-FQ-302A and SNW-FQ-302B.	

UHF power LDMOS transistor

BLF2043F

**THERMAL CHARACTERISTICS**

SYMBOL	PARAMETER	CONDITIONS	VALUE	UNIT
$R_{th\ j-mb}$	thermal resistance from junction to mounting base	$T_{mb} = 25\text{ °C}$ ; note 1	5	K/W
$R_{th\ mb-h}$	thermal resistance from mounting base to heatsink		0.5	K/W

**Note**

1. Thermal resistance is determined under RF operating conditions.

**CHARACTERISTICS**

$T_j = 25\text{ °C}$  unless otherwise specified.

SYMBOL	PARAMETER	CONDITIONS	MIN.	TYP.	MAX.	UNIT
$V_{(BR)DSS}$	drain-source breakdown voltage	$V_{GS} = 0$ ; $I_D = 0.2\text{ mA}$	75	–	–	V
$V_{GSth}$	gate-source threshold voltage	$V_{DS} = 10\text{ V}$ ; $I_D = 20\text{ mA}$	4	–	5	V
$I_{DSS}$	drain-source leakage current	$V_{GS} = 0$ ; $V_{DS} = 26\text{ V}$	–	–	1.5	$\mu\text{A}$
$I_{DSX}$	on-state drain current	$V_{GS} = V_{GSth} + 9\text{ V}$ ; $V_{DS} = 10\text{ V}$	2.8	–	–	A
$I_{GSS}$	gate leakage current	$V_{GS} = \pm 15\text{ V}$ ; $V_{DS} = 0$	–	–	40	nA
$g_{fs}$	forward transconductance	$V_{DS} = 10\text{ V}$ ; $I_D = 0.75\text{ A}$	–	0.5	–	S
$R_{DSon}$	drain-source on-state resistance	$V_{GS} = 10\text{ V}$ ; $I_D = 0.75\text{ A}$	–	1.2	–	$\Omega$
$C_{is}$	input capacitance	$V_{GS} = 0$ ; $V_{DS} = 26\text{ V}$ ; $f = 1\text{ MHz}$	–	13	–	pF
$C_{os}$	output capacitance	$V_{GS} = 0$ ; $V_{DS} = 26\text{ V}$ ; $f = 1\text{ MHz}$	–	11	–	pF
$C_{rs}$	feedback capacitance	$V_{GS} = 0$ ; $V_{DS} = 26\text{ V}$ ; $f = 1\text{ MHz}$	–	0.5	–	pF

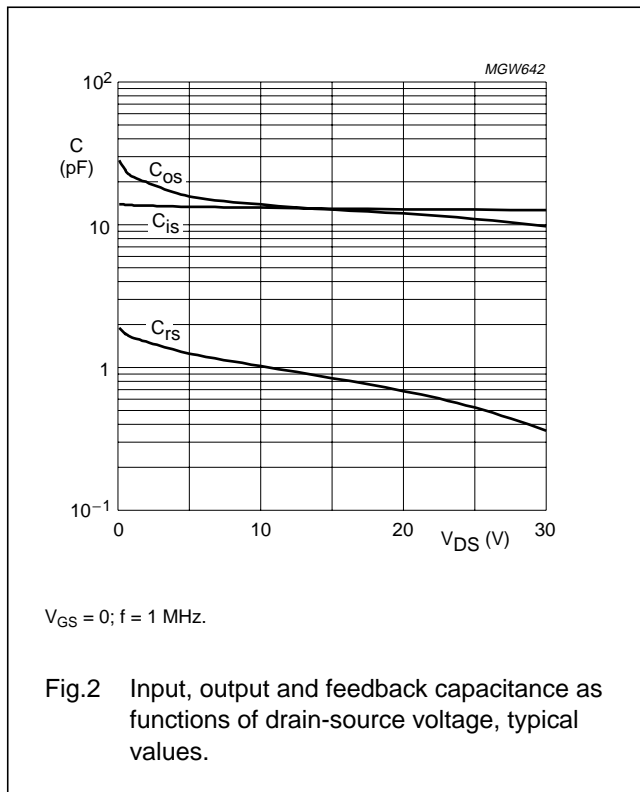

UHF power LDMOS transistor

BLF2043F

APPLICATION INFORMATION

RF performance in a common source class-AB circuit.  $T_h = 25\text{ }^\circ\text{C}$ ;  $R_{th\text{ mb-h}} = 0.4\text{ K/W}$ ; unless otherwise specified.

MODE OF OPERATION	f (MHz)	$V_{DS}$ (V)	$I_{DQ}$ (mA)	$P_L$ (W)	$G_p$ (dB)	$\eta_D$ (%)	$d_{im}$ (dBc)
CW, class-AB (2-tone)	$f_1 = 2200; f_2 = 2200.1$	26	85	10 (PEP)	>11	>30	$\leq -26$

Ruggedness in class-AB operation

The BLF2043F is capable of withstanding a load mismatch corresponding to  $V_{SWR} = 10 : 1$  through all phases under the following conditions:  $V_{DS} = 26\text{ V}$ ;  $f = 2200\text{ MHz}$  at rated load power.

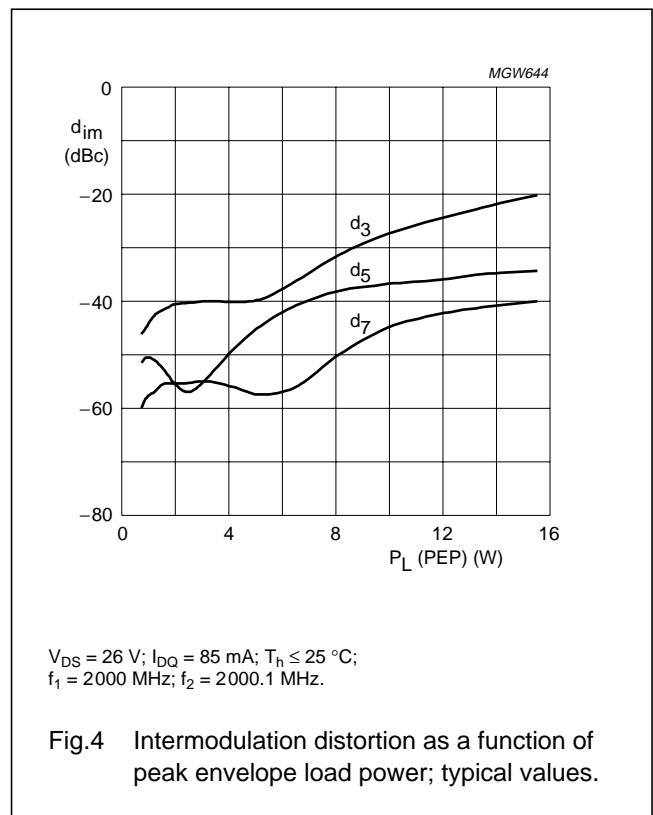
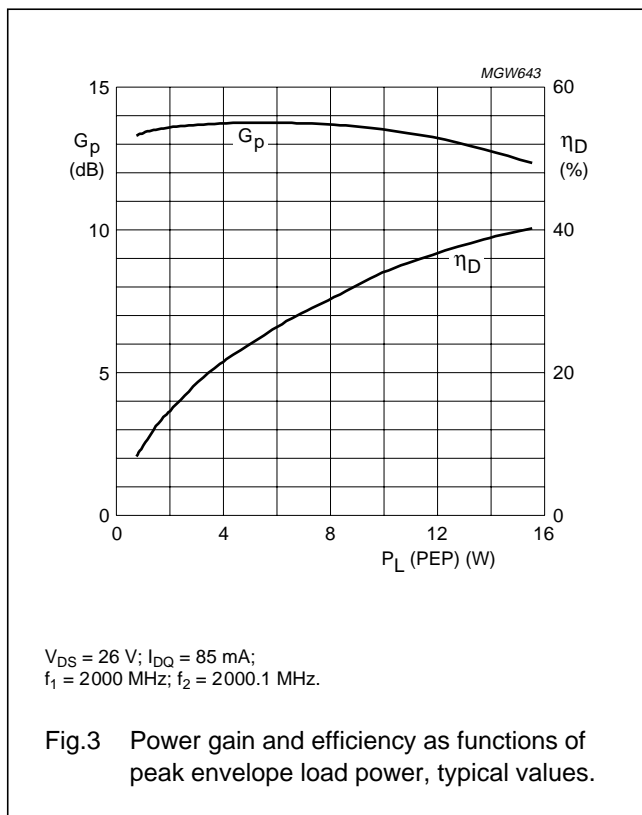

UHF power LDMOS transistor

BLF2043F

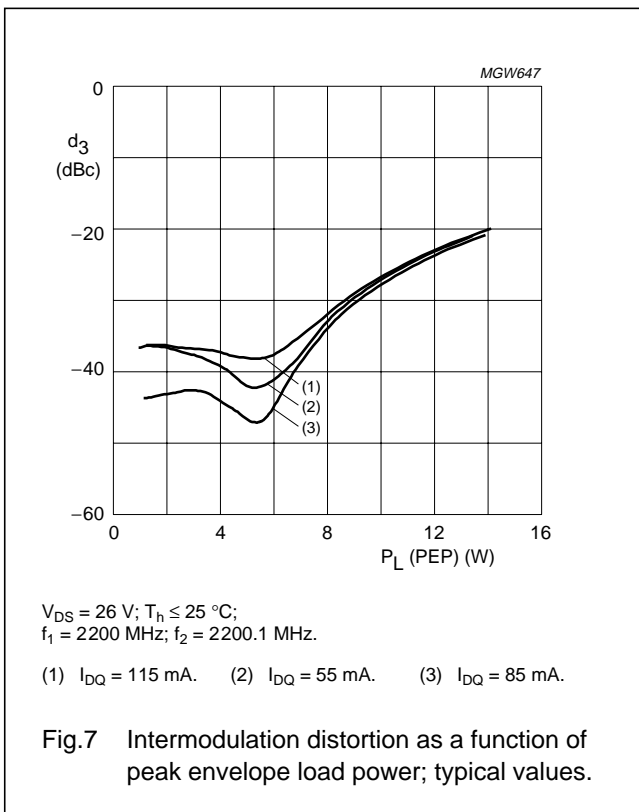
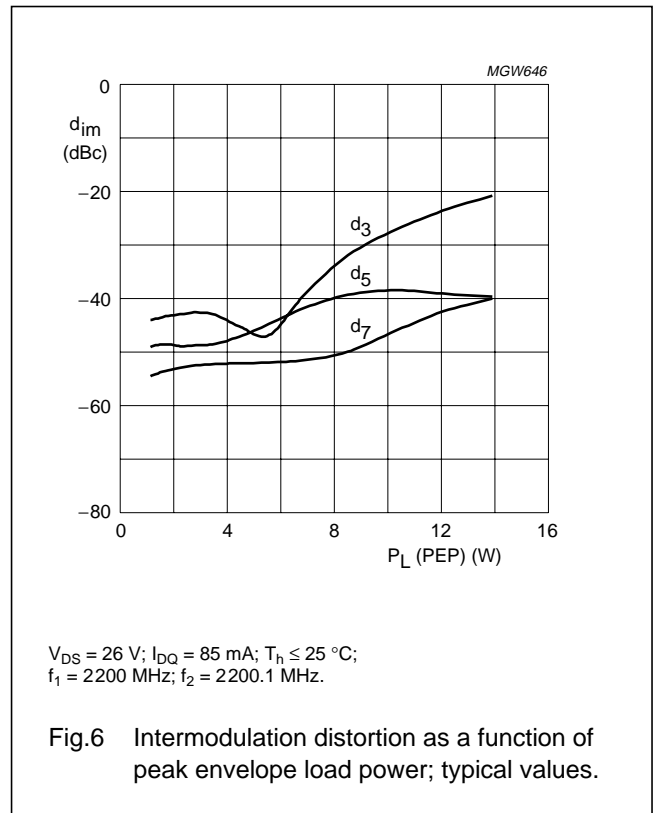
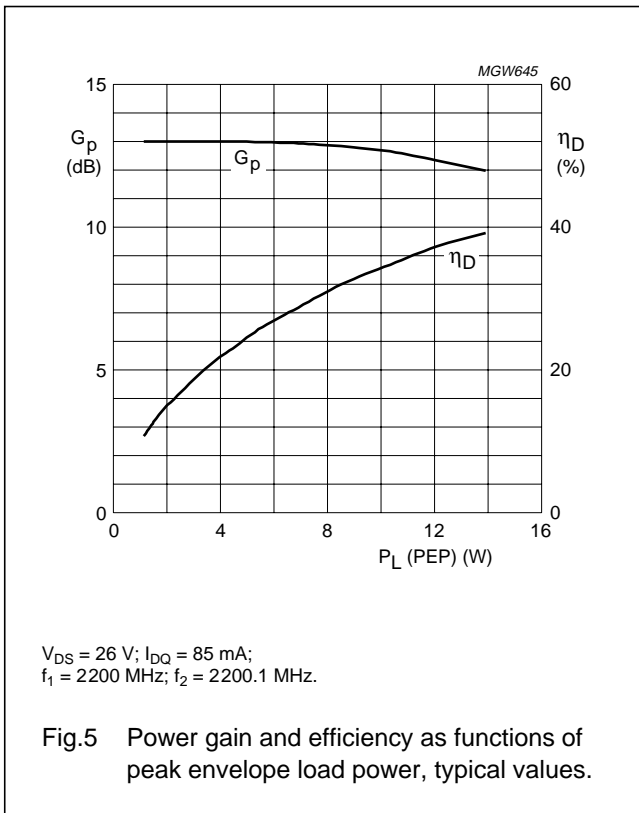

UHF power LDMOS transistor

BLF2043F

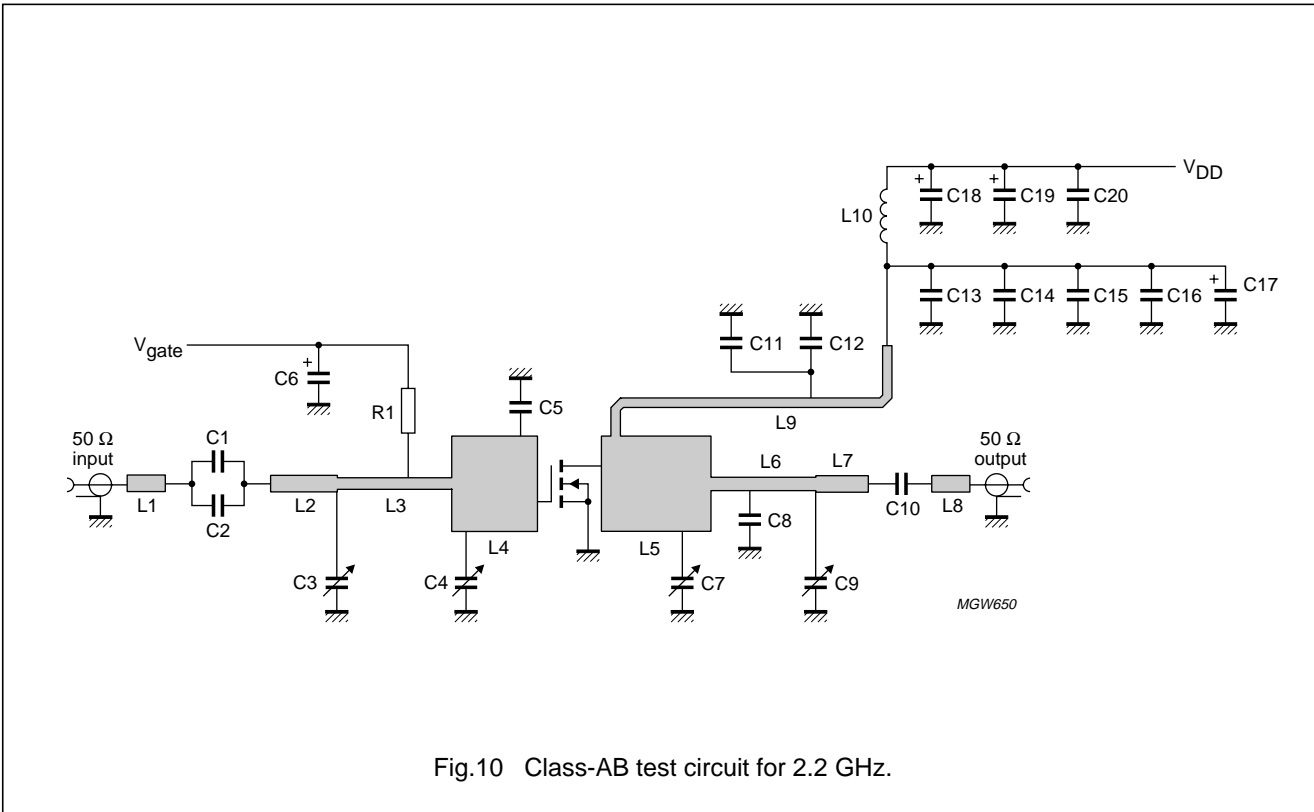
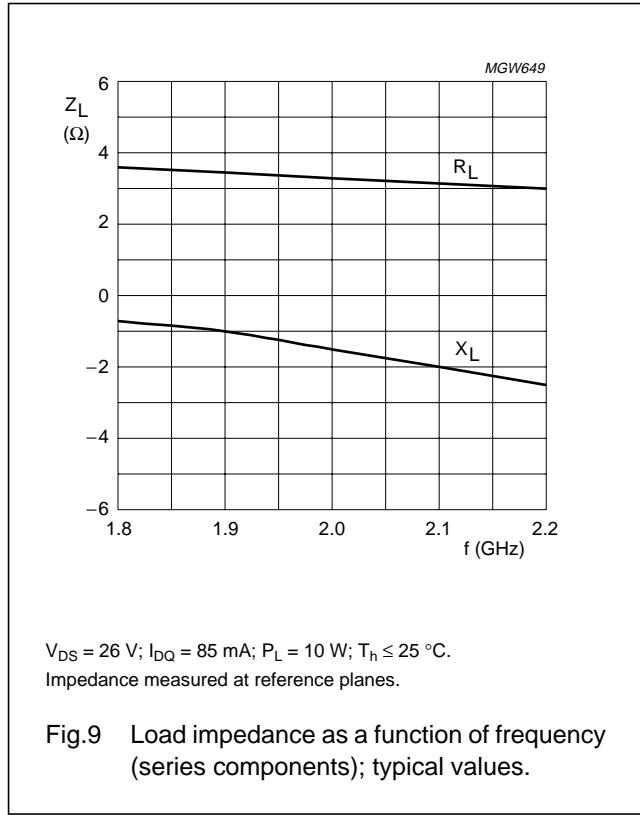
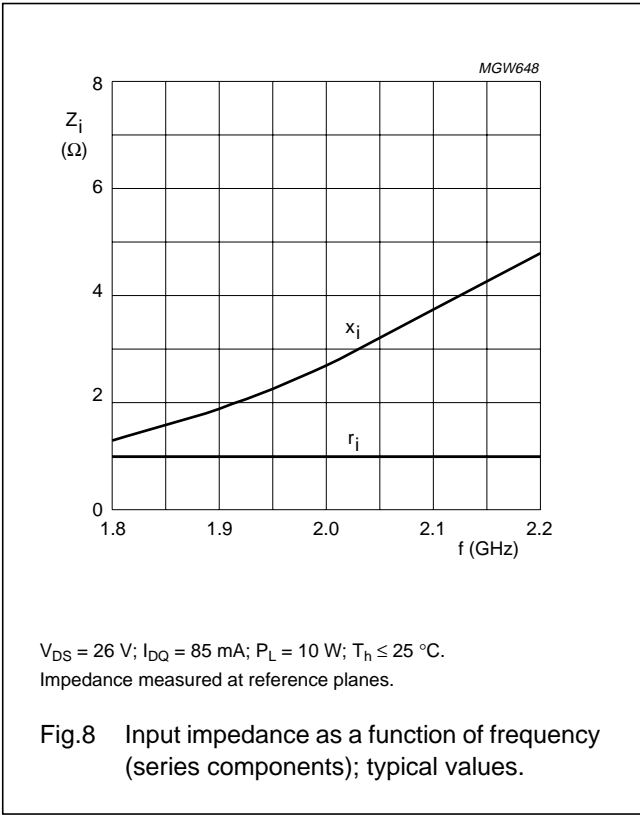

## UHF power LDMOS transistor

BLF2043F

## List of components (see Figs 10 and 11)

COMPONENT	DESCRIPTION	VALUE	DIMENSIONS	CATALOGUE NO.
C1, C2, C10, C11	multilayer ceramic chip capacitor; note 1	6.8 pF		
C3, C4, C7, C9	Tekelec variable capacitor; type 37271	0.6 to 4.5 pF		
C5	multilayer ceramic chip capacitor; note 1	2.4 pF		
C6, C18	tantalum SMD capacitor	10 $\mu$ F; 35 V		
C8	multilayer ceramic chip capacitor; note 1	1.5 pF		
C12, C20	multilayer ceramic chip capacitor; note 2	1 nF		
C13	multilayer ceramic chip capacitor; note 1	10 pF		
C14	multilayer ceramic chip capacitor; note 1	51 pF		
C15	multilayer ceramic chip capacitor; note 1	120 pF		
C16	multilayer ceramic chip capacitor	100 nF		2222 581 16641
C17	electrolytic capacitor	47 $\mu$ F; 35 V		2222 036 90094
C19	electrolytic capacitor	100 $\mu$ F; 63 V		2222 037 58101
L1, L8	stripline; note 3	50 $\Omega$	4 $\times$ 1.5 mm	
L2	stripline; note 3	50 $\Omega$	7 $\times$ 1.5 mm	
L3	stripline; note 3	58.1 $\Omega$	12 $\times$ 1.2 mm	
L4	stripline; note 3	11.3 $\Omega$	9 $\times$ 10 mm	
L5	stripline; note 3	11.3 $\Omega$	11.5 $\times$ 10 mm	
L6	stripline; note 3	52.8 $\Omega$	11 $\times$ 1.4 mm	
L7	stripline; note 3	50 $\Omega$	5.5 $\times$ 1.5 mm	
L9	stripline; note 3	64.7 $\Omega$	38 $\times$ 1 mm	
L10	2 turns enamelled 0.5 mm copper wire		int. dia. = 3 mm; length = 3 mm	
R1	metal film resistor	390 $\Omega$ ; 0.6 W		2322 156 11009

## Notes

1. American Technical Ceramics type 100A or capacitor of same quality.
2. American Technical Ceramics type 100B or capacitor of same quality.
3. The striplines are on a double copper-clad printed-circuit board with Rogers 5880 dielectric ( $\epsilon_r = 2.2$ ); thickness 0.51 mm.

UHF power LDMOS transistor

BLF2043F

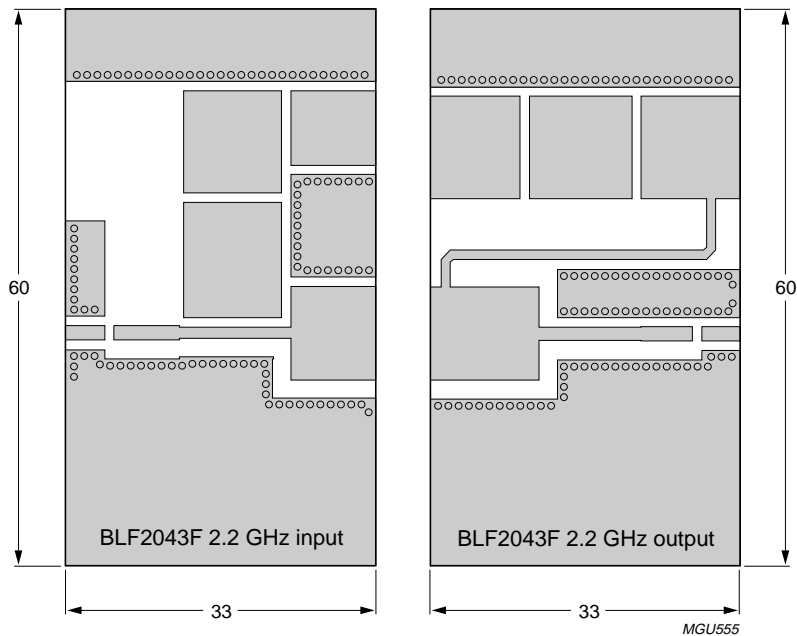
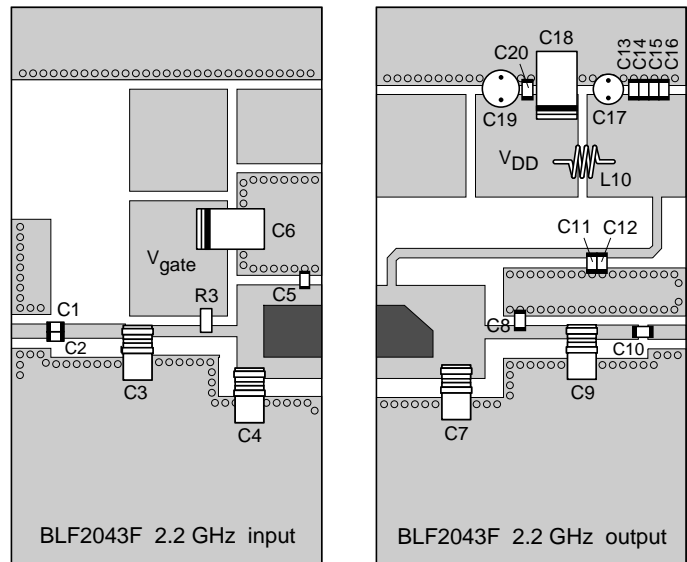

Dimensions in mm.

The components are situated on one side of the copper-clad printed-circuit board with Teflon dielectric ( $\epsilon_r = 2.2$ ), thickness 0.51 mm. The other side is unetched and serves as a ground plane.

Fig.11 Component layout for 2.2 GHz class-AB test circuit.



UHF power LDMOS transistor

BLF2043F

PACKAGE OUTLINE

Flanged LDMOST ceramic package; 2 mounting holes; 2 leads

SOT467C

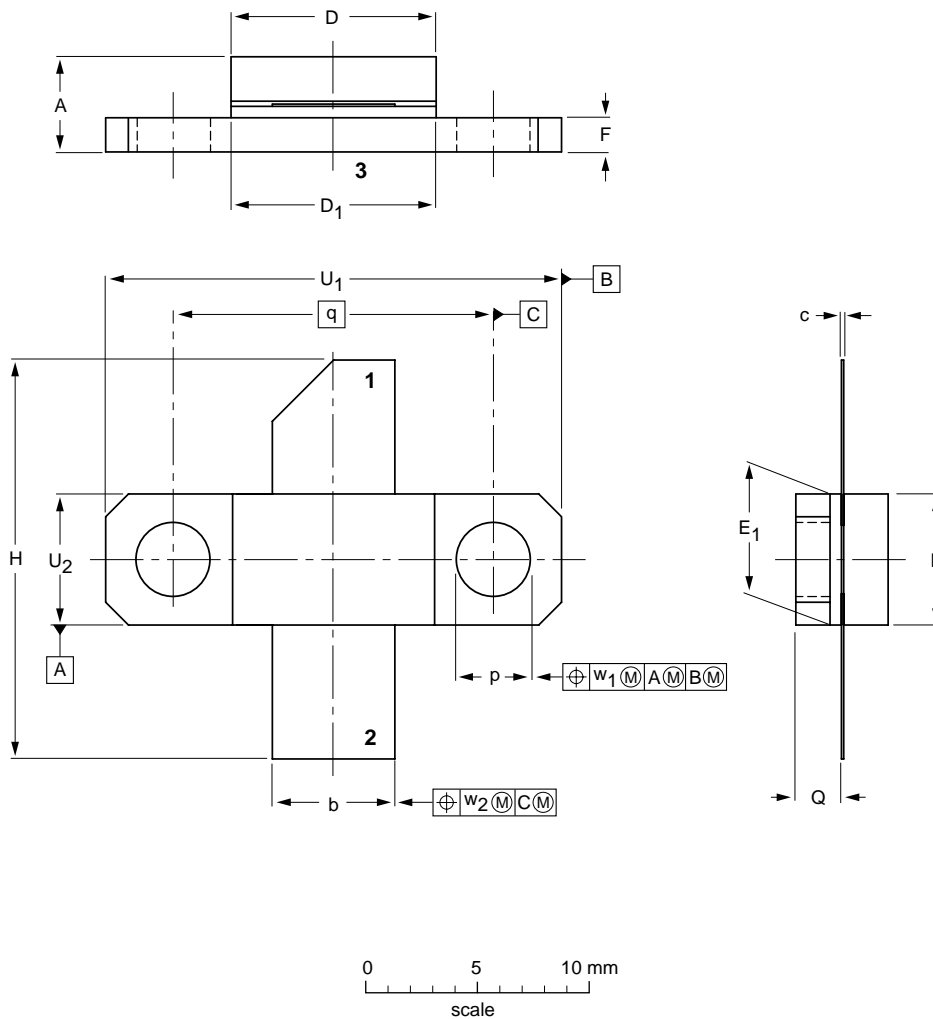

DIMENSIONS (millimetre dimensions are derived from the original inch dimensions)

UNIT	A	b	c	D	D <sub>1</sub>	E	E <sub>1</sub>	F	H	p	Q	q	U <sub>1</sub>	U <sub>2</sub>	w <sub>1</sub>	w <sub>2</sub>
mm	4.67 3.94	5.59 5.33	0.15 0.10	9.25 9.04	9.27 9.02	5.92 5.77	5.97 5.72	1.65 1.40	18.54 17.02	3.43 3.18	2.21 1.96	14.27	20.45 20.19	5.97 5.72	0.25	0.51
inch	0.184 0.155	0.220 0.210	0.006 0.004	0.364 0.356	0.365 0.355	0.233 0.227	0.235 0.225	0.065 0.055	0.73 0.67	0.135 0.125	0.087 0.077	0.562	0.805 0.795	0.235 0.225	0.010	0.020

OUTLINE VERSION	REFERENCES				EUROPEAN PROJECTION	ISSUE DATE
	IEC	JEDEC	EIAJ			
SOT467C						99-12-06 99-12-28

## UHF power LDMOS transistor

BLF2043F

## DATA SHEET STATUS

DATA SHEET STATUS <sup>(1)</sup>	PRODUCT STATUS <sup>(2)</sup>	DEFINITIONS
Objective data	Development	This data sheet contains data from the objective specification for product development. Philips Semiconductors reserves the right to change the specification in any manner without notice.
Preliminary data	Qualification	This data sheet contains data from the preliminary specification. Supplementary data will be published at a later date. Philips Semiconductors reserves the right to change the specification without notice, in order to improve the design and supply the best possible product.
Product data	Production	This data sheet contains data from the product specification. Philips Semiconductors reserves the right to make changes at any time in order to improve the design, manufacturing and supply. Changes will be communicated according to the Customer Product/Process Change Notification (CPCN) procedure SNW-SQ-650A.

## Notes

1. Please consult the most recently issued data sheet before initiating or completing a design.
2. The product status of the device(s) described in this data sheet may have changed since this data sheet was published. The latest information is available on the Internet at URL <http://www.semiconductors.philips.com>.

## DEFINITIONS

**Short-form specification** — The data in a short-form specification is extracted from a full data sheet with the same type number and title. For detailed information see the relevant data sheet or data handbook.

**Limiting values definition** — Limiting values given are in accordance with the Absolute Maximum Rating System (IEC 60134). Stress above one or more of the limiting values may cause permanent damage to the device. These are stress ratings only and operation of the device at these or at any other conditions above those given in the Characteristics sections of the specification is not implied. Exposure to limiting values for extended periods may affect device reliability.

**Application information** — Applications that are described herein for any of these products are for illustrative purposes only. Philips Semiconductors make no representation or warranty that such applications will be suitable for the specified use without further testing or modification.

## DISCLAIMERS

**Life support applications** — These products are not designed for use in life support appliances, devices, or systems where malfunction of these products can reasonably be expected to result in personal injury. Philips Semiconductors customers using or selling these products for use in such applications do so at their own risk and agree to fully indemnify Philips Semiconductors for any damages resulting from such application.

**Right to make changes** — Philips Semiconductors reserves the right to make changes, without notice, in the products, including circuits, standard cells, and/or software, described or contained herein in order to improve design and/or performance. Philips Semiconductors assumes no responsibility or liability for the use of any of these products, conveys no licence or title under any patent, copyright, or mask work right to these products, and makes no representations or warranties that these products are free from patent, copyright, or mask work right infringement, unless otherwise specified.

UHF power LDMOS transistor

BLF2043F

---

**NOTES**

# ***Philips Semiconductors – a worldwide company***

## **Contact information**

For additional information please visit <http://www.semiconductors.philips.com>. Fax: **+31 40 27 24825**

For sales offices addresses send e-mail to: [sales.addresses@www.semiconductors.philips.com](mailto:sales.addresses@www.semiconductors.philips.com).

© Koninklijke Philips Electronics N.V. 2002

SCA74

All rights are reserved. Reproduction in whole or in part is prohibited without the prior written consent of the copyright owner.

The information presented in this document does not form part of any quotation or contract, is believed to be accurate and reliable and may be changed without notice. No liability will be accepted by the publisher for any consequence of its use. Publication thereof does not convey nor imply any license under patent- or other industrial or intellectual property rights.

Printed in The Netherlands

613524/02/pp12

Date of release: 2002 Mar 05

Document order number: 9397 750 09171

*Let's make things better.*

**Philips  
Semiconductors**



**PHILIPS**