

Gate Driver Providing Galvanic Isolation Series

Isolation Voltage 3750 Vrms

1ch Gate Driver Providing Galvanic Isolation

BM61S41RFV-C

General Description

The BM61S41RFV-C is a gate driver with an isolation voltage of 3750 Vrms, I/O delay time of 65 ns, and minimum input pulse width of 60 ns. It has the Under-Voltage Lockout (UVLO) function and Miller clamp function.

Key Specifications

■ Isolation Voltage:	3750 Vrms
■ Maximum Gate Drive Voltage:	24 V
■ I/O Delay Time:	65 ns(Max)
■ Minimum Input Pulse Width:	60 ns
■ Output Current	4 A

Features

- AEC-Q100 Qualified (Note 1)
- Providing Galvanic Isolation
- Active Miller Clamping
- Under-Voltage Lockout Function
- UL1577 (pending)
(Note 1) Grade1

Applications

- SiC MOSFET Gate Drive

Package

SSOP-B10W

W(Typ) x D(Typ) x H(Max)
3.5 mm x 10.2 mm x 1.9 mm



Typical Application Circuits

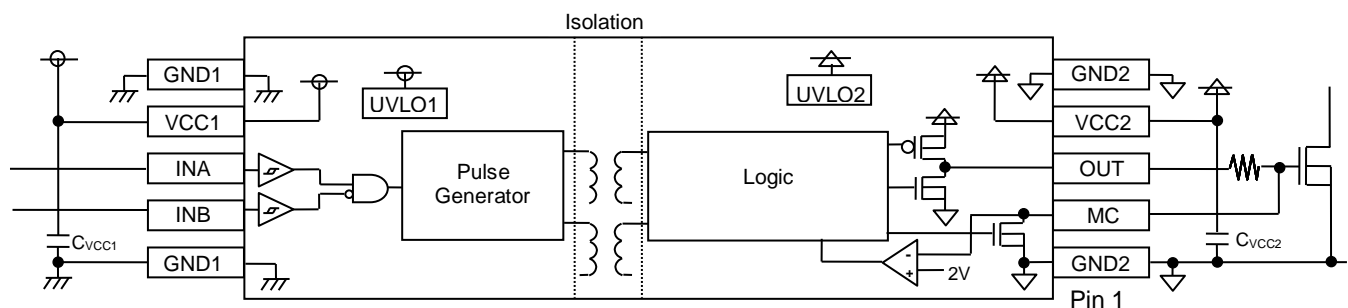

Figure 1. For Driving SiC without Negative Power Supply

○Product structure : Silicon integrated circuit ○This product has no designed protection against radioactive rays

Contents

General Description	1
Features	1
Applications	1
Key Specifications	1
Package W(Typ) x D(Typ) x H(Max)	1
Typical Application Circuits	1
Contents	2
Recommended Range of External Constants	3
Pin Configurations	3
Pin Descriptions	3
Description of Functions and Examples of Constant Setting	5
Absolute Maximum Ratings	8
Thermal Resistance ^(Note 5)	8
Recommended Operating Conditions	9
Insulation Related Characteristics	9
Electrical Characteristics	10
Typical Performance Curves	11
Figure 7. Input-side Circuit Current 1 vs Input-side Supply Voltage	11
Figure 8. Input-side Circuit Current 1 vs Temperature	11
Figure 9. Input-side Circuit Current 2 vs Input-side Supply Voltage (At INA=100 kHz, Duty=50 %)	11
Figure 10. Input-side Circuit Current 2 vs Temperature (At INA=100 kHz, Duty=50 %)	11
Figure 11. Output-side Circuit Current 1 vs Output-side Supply Voltage (At OUT=L)	12
Figure 12. Output-side Circuit Current 1 vs Temperature (At OUT=L)	12
Figure 13. Output-side Circuit Current 2 vs Output-side Supply Voltage (At OUT=H)	12
Figure 14. Output-side Circuit Current 2 vs Temperature (At OUT=H)	12
Figure 15. Logic High/Low Level Input Voltage	13
Figure 16. Output Voltage vs Logic Level Input Voltage (INA)	13
Figure 17. Logic Pull-up/down Resistance vs Temperature	13
Figure 18. Logic Input Minimum Pulse Width vs Temperature	13
Figure 19. OUT ON Resistance (Source) vs Temperature	14
Figure 20. OUT ON Resistance (Sink) vs Temperature	14
Figure 21. Turn ON Time vs Temperature	14
Figure 22. Turn OFF Time vs Temperature	14
Figure 23. Turn ON Time vs Temperature (INA=H, INB=PWM)	15
Figure 24. Turn OFF Time vs Temperature (INA=H, INB=PWM)	15
Figure 25. MC ON Resistance vs Temperature	15
Figure 26. MC ON Threshold Voltage vs Temperature	15
Figure 27. V _{CC1} UVLO ON/OFF Voltage vs Temperature	16
Figure 28. V _{CC1} UVLO Mask Time vs Temperature	16
Figure 29. V _{CC2} UVLO ON/OFF Voltage vs Temperature	16
Figure 30. V _{CC2} UVLO Mask Time vs Temperature	16
Application Examples	17
I/O Equivalence Circuits	18
Operational Notes	19
1. Reverse Connection of Power Supply	19
2. Power Supply Lines	19
3. Ground Voltage	19
4. Ground Wiring Pattern	19
5. Recommended Operating Conditions	19
6. Inrush Current	19
7. Testing on Application Boards	19
8. Inter-pin Short and Mounting Errors	19
9. Unused Input Pins	20
10. Regarding the Input Pin of the IC	20
11. Ceramic Capacitor	20
Ordering Information	21
Marking Diagram	21
Physical Dimension and Packing Information	22
Revision History	23

Recommended Range of External Constants

Pin Name	Symbol	Recommended Value			Unit
		Min	Typ	Max	
VCC1	C _{VCC1}	0.1	1.0	-	μF
VCC2	C _{VCC2}	0.01	-(Note 2)	-	μF

(Note 2) Value according to the load

Pin Configurations

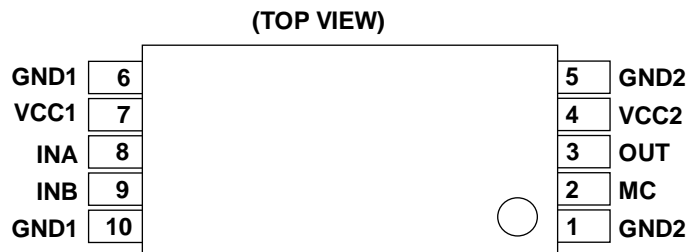

Pin Descriptions

Pin No.	Pin Name	Function
1	GND2	Output-side ground pin
2	MC	Miller clamp pin
3	OUT	Output pin
4	VCC2	Output-side power supply pin
5	GND2	Output-side ground pin
6	GND1	Input-side ground pin
7	VCC1	Input-side power supply pin
8	INA	Control input A pin
9	INB	Control input B pin
10	GND1	Input-side ground pin

Pin Descriptions - continued

1. VCC1 (Input-side Power Supply Pin)

The VCC1 pin is a power supply pin on the input side. To suppress voltage fluctuations due to the current to drive internal transformers, connect a bypass capacitor between the VCC1 and the GND1 pins.

2. GND1 (Input-side Ground Pin)

The GND1 pin is a ground pin on the input side.

3. VCC2 (Output-side Power Supply Pin)

The VCC2 pin is a power supply pin on the output side. To reduce voltage fluctuations due to OUT pin output current, connect a bypass capacitor between the VCC2 and the GND2 pins.

4. GND2 (Output-side Ground Pin)

The GND2 pin is a ground pin on the output side.

5. INA, INB (Control Input A/B Pin)

The INA and INB pins are used to determine output logic.

INB	INA	OUT
H	L	L
H	H	L
L	L	L
L	H	H

6. OUT (Output Pin)

The OUT pin is used to drive the gate of a power device.

7. MC (Miller Clamp Pin)

The MC pin is for preventing the increase in gate voltage due to the Miller current of the power device connected to the OUT pin. If the Miller Clamp function is not used, short-circuit the MC pin to the GND2 pin.

Description of Functions and Examples of Constant Setting

1. Miller Clamp Function

When the INA=L or INB=H and OUT pin voltage < V_{MCON} (Typ 2V), the internal MOSFET of the MC pin is turned ON.

INA	INB	MC	Internal MOSFET of the MC Pin
L	X	Less Than V_{MCON}	ON
X	H	Less Than V_{MCON}	ON
H	L	X	OFF

X: Don't care

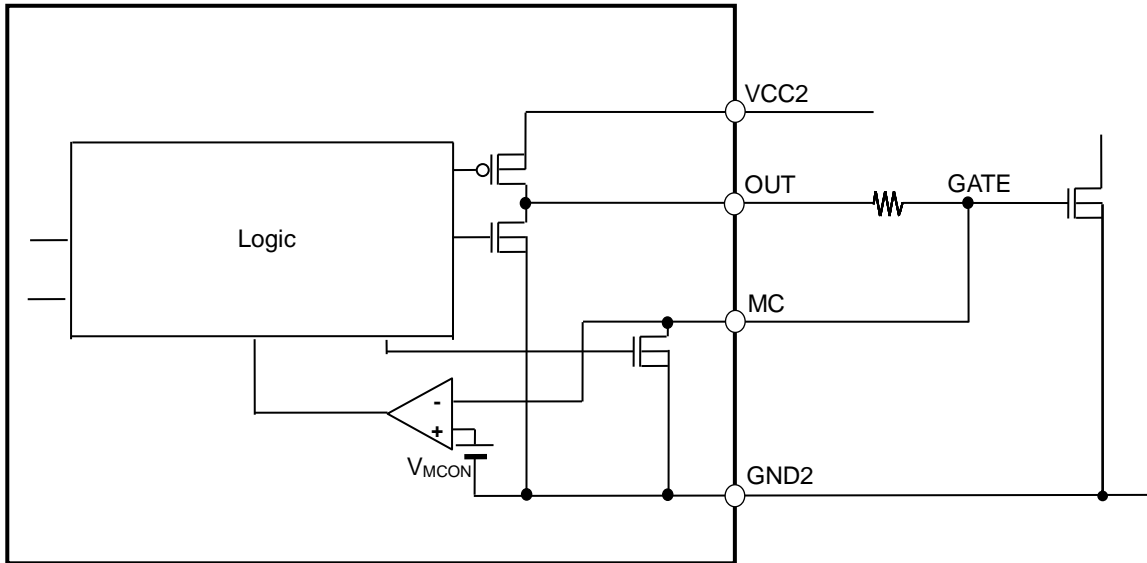

Figure 2. Block Diagram of Miller Clamp Function

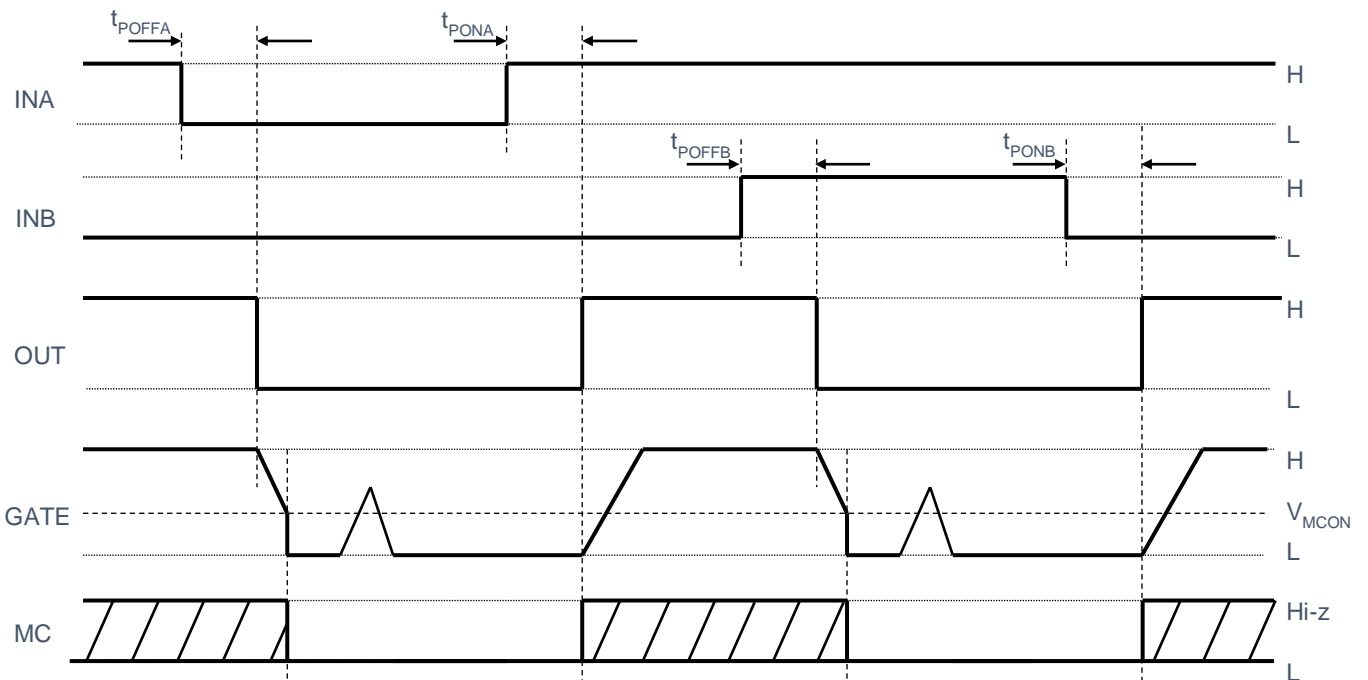

Figure 3. Timing Chart of Miller Clamp Function

Description of Functions and Examples of Constant Setting - continued

2. Under-Voltage Lockout (UVLO) Function

The BM61S41RFV-C has the Under-Voltage Lockout (UVLO) function both on the Input-side and the output-side. When the power supply voltage drops to the UVLO ON voltage (input-side Typ 4.0 V, output-side 14.5 V), the OUT pin will output the "L" signal. In addition, to prevent malfunctions due to noises, a mask time of $t_{UVLO1MSK}$ (Typ 1.5 μ s) and $t_{UVLO2MSK}$ (Typ 2.9 μ s) are set on both the input-side and the output-side. After the UVLO on Input-side is released, the input signal will take effect from when the time after the input signal switches.

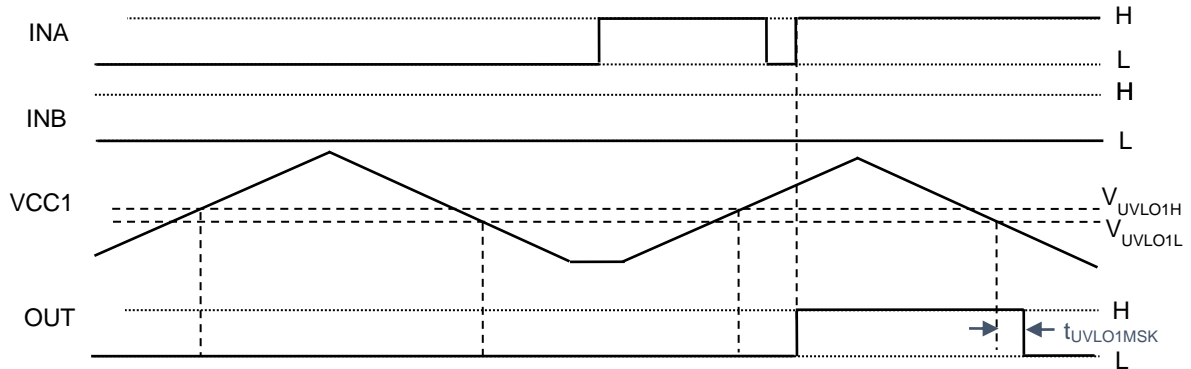

Figure 4. Timing Chart of Input-side UVLO Function

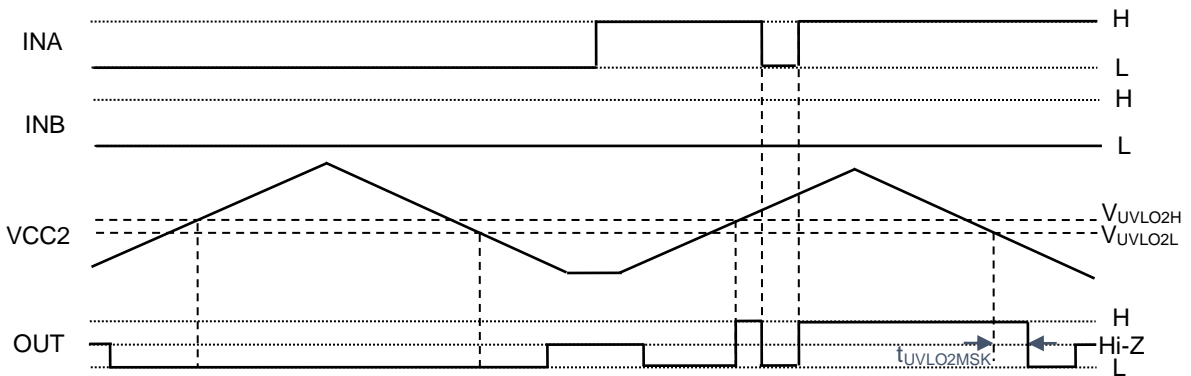

Figure 5. Timing Chart of Output-side UVLO Function

Description of Functions and Examples of Constant Setting - continued

3. I/O Condition Table

No.	Status	Input				Output	
		VCC1	VCC2	INB	INA	OUT	MC
1	VCC1 UVLO	UVLO	X	X	X	L	L
2	VCC2 UVLO	X	UVLO	X	X	L	L
3	INB Active	No UVLO	No UVLO	H	X	L	L
4	Normal Operation L Input	No UVLO	No UVLO	L	L	L	L
5	Normal Operation H input	No UVLO	No UVLO	L	H	H	Hi-Z

X: Don't care

Absolute Maximum Ratings

Parameter	Symbol	Limits	Unit
Input-side Supply Voltage	V _{CC1}	-0.3 to +7.0 ^(Note 3)	V
Output-side Supply Voltage	V _{CC2}	-0.3 to +30.0 ^(Note 4)	V
INA Pin Input Voltage	V _{INA}	-0.3 to +V _{CC1} +0.3 or +7.0 ^(Note 3)	V
INB Pin Input Voltage	V _{INB}	-0.3 to +V _{CC1} +0.3 or +7.0 ^(Note 3)	V
OUT Pin Output Current (Peak 10μs)	I _{OUTPEAK}	self limited	A
Storage Temperature Range	T _{stg}	-55 to +150	°C
Maximum Junction Temperature	T _{jmax}	+150	°C

Caution 1: Operating the IC over the absolute maximum ratings may damage the IC. The damage can either be a short circuit between pins or an open circuit between pins and the internal circuitry. Therefore, it is important to consider circuit protection measures, such as adding a fuse, in case the IC is operated over the absolute maximum ratings.

Caution 2: Should by any chance the maximum junction temperature rating be exceeded the rise in temperature of the chip may result in deterioration of the properties of the chip. In case of exceeding this absolute maximum rating, design a PCB with thermal resistance taken into consideration by increasing board size and copper area so as not to exceed the maximum junction temperature rating.

(Note 3) Relative to GND1.

(Note 4) Relative to GND2.

Thermal Resistance ^(Note 5)

Parameter	Symbol	Thermal Resistance (Typ)		Unit
		1s ^(Note 7)	2s2p ^(Note 8)	
SSOP-B10W				
Input-side Junction to Ambient	θ _{JA1}	172.1	101.8	°C/W
Output-side Junction to Ambient	θ _{JA2}	180.2	108.9	°C/W
Input-side Junction to Top Characterization Parameter ^(Note 6)	Ψ _{JT1}	32	27	°C/W
Output-side Junction to Top Characterization Parameter ^(Note 6)	Ψ _{JT2}	82	60	°C/W

(Note 5) Based on JESD51-2A (Still-Air)

(Note 6) The thermal characterization parameter to report the difference between junction temperature and the temperature at the top center of the outside surface of the component package.

(Note 7) Using a PCB board based on JESD51-3.

(Note 8) Using a PCB board based on JESD51-7.

Layer Number of Measurement Board	Material	Board Size
Single	FR-4	114.3 mm x 76.2 mm x 1.57 mmt

Top	
Copper Pattern	Thickness
Footprints and Traces	70 μm

Layer Number of Measurement Board	Material	Board Size
4 Layers	FR-4	114.3 mm x 76.2 mm x 1.6 mmt

Top		2 Internal Layers		Bottom	
Copper Pattern	Thickness	Copper Pattern	Thickness	Copper Pattern	Thickness
Footprints and Traces	70 μm	74.2 mm x 74.2 mm	35 μm	74.2 mm x 74.2 mm	70 μm

Recommended Operating Conditions

Parameter	Symbol	Min	Max	Unit
Input-side Supply Voltage	V_{CC1} (Note 9)	4.5	5.5	V
Output-side Supply Voltage	V_{CC2} (Note 10)	16	24	V
Operating Temperature	T_{opr}	-40	+125	°C

(Note 9) Relative to GND1.

(Note 10) Relative to GND2.

Insulation Related Characteristics**Reinforced Insulation Requirements according to VDE0884-10(pending)**

Parameter	Symbol	Characteristic	Unit
Insulation Classification Per EN 60664-1, Table 1 For Rated Main Voltage < 150 Vrms For Rated Main Voltage < 300 Vrms For Rated Main Voltage < 450 Vrms For Rated Main Voltage < 600 Vrms		Rated Impulse Voltage I - IV I - IV I - III I - III	-
Climatic Classification		40/125/21	-
Pollution Degree(EN 60664-1)		2	-
Minimum External Clearance	CLR	8.1	mm
Minimum External Creepage	CPG	8.1	mm
Minimum Internal Gap (Internal Clearance)		0.012	mm
Minimum Comparative Tracking Index	CTI	>400	-
Minimum Repetitive Insulation Voltage	V_{IORM}	891	V_{PK}
Input to Output Test Voltage, Method b $V_{IORM} \times 1.875 = V_{PR}$, Productive Test, $t_m = 1$ s, Partial Discharge < 5 pC	V_{PR}	1671	
Surge Isolation Voltage	V_{IOSM}	6000	
Highest Allowable Voltage, 1 min	V_{IOTM}	3750	Vrms
Insulation Resistance at T_s , $V_{IO} = 500$ V	R_{IO}	>10 ⁹	Ω

Recognized under UL 1577 (pending)

Description	Symbol	Characteristic	Unit
Insulation Withstand Voltage / 1 min	V_{ISO}	3750	Vrms
Insulation Test Voltage / 1 s	V_{ISO}	4500	Vrms

Electrical Characteristics

(Unless otherwise specified Ta=-40°C to +125°C, V_{CC1}=4.5 V to 5.5 V, V_{CC2}=16 V to 24 V)

Parameter	Symbol	Min	Typ	Max	Unit	Conditions
General						
Input-side Circuit Current 1	I _{CC11}	0.2	0.4	1.0	mA	INA=L, INB=H
Input-side Circuit Current 2	I _{CC12}	1.0	2.0	4.0	mA	INA=100kHz, Duty=50%
Output-side Circuit Current 1	I _{CC21}	0.30	0.70	1.20	mA	OUT=L
Output-side Circuit Current 2	I _{CC22}	0.22	0.52	0.90	mA	OUT=H
Logic Block						
Logic High Level Input Voltage	V _{INH}	2.0	-	V _{CC1}	V	INA, INB
Logic Low Level Input Voltage	V _{INL}	0	-	0.8	V	INA, INB
Logic Pull-down Resistance	R _{IND}	25	50	100	kΩ	INA
Logic Pull-up Resistance	R _{INU}	25	50	100	kΩ	INB
Logic Input Minimum Pulse Width	t _{INMIN}	60	-	-	ns	INA, INB
Output						
OUT ON Resistance (Source)	R _{ONH}	0.3	0.67	1.5	Ω	I _{OUT} =-40 mA
OUT ON Resistance (Sink)	R _{ONL}	0.15	0.45	0.98	Ω	I _{OUT} =40 mA
OUT Maximum Current (Source)	I _{OUTMAXH}	4.0	-	-	A	V _{CC2} =18 V, Guaranteed by Design
OUT Maximum Current (Sink)	I _{OUTMAXL}	4.0	-	-	A	V _{CC2} =18 V, Guaranteed by Design
Turn ON Time	t _{PONA}	45	55	65	ns	INA=PWM, INB=L
	t _{PONB}	45	55	65	ns	INA=H, INB=PWM
Turn OFF Time	t _{POFFA}	45	55	65	ns	INA=PWM, INB=L
	t _{POFFB}	45	55	65	ns	INA=H, INB=PWM
Propagation Distortion	t _{PDISTA}	-10	0	+10	ns	t _{POFFA} - t _{PONA}
	t _{PDISTB}	-10	0	+10	ns	t _{POFFB} - t _{PONB}
Part to Part Skew	t _{SK-PP}	-	-	20	ns	
Rise Time	t _{RISE}	-	15	-	ns	2 nF between OUT-GND2
Fall Time	t _{FALL}	-	15	-	ns	2 nF between OUT-GND2
MC ON Resistance	R _{ONMC}	0.15	0.45	0.98	Ω	I _{MC} =40 mA
MC ON Threshold Voltage	V _{MCON}	1.8	2	2.2	V	
Common Mode Transient Immunity	CM	100	-	-	kV/μs	Guaranteed by Design
Protection Functions						
V _{CC1} UVLO OFF Voltage	V _{UVLO1H}	3.95	4.2	4.45	V	
V _{CC1} UVLO ON Voltage	V _{UVLO1L}	3.75	4.0	4.25	V	
V _{CC1} UVLO Mask Time	t _{UVLO1MSK}	0.4	1.5	5.0	μs	
V _{CC2} UVLO OFF Voltage	V _{UVLO2H}	14.6	15.0	15.4	V	
V _{CC2} UVLO ON Voltage	V _{UVLO2L}	14.1	14.5	14.9	V	
V _{CC2} UVLO Mask Time	t _{UVLO2MSK}	1.0	2.9	5.0	μs	

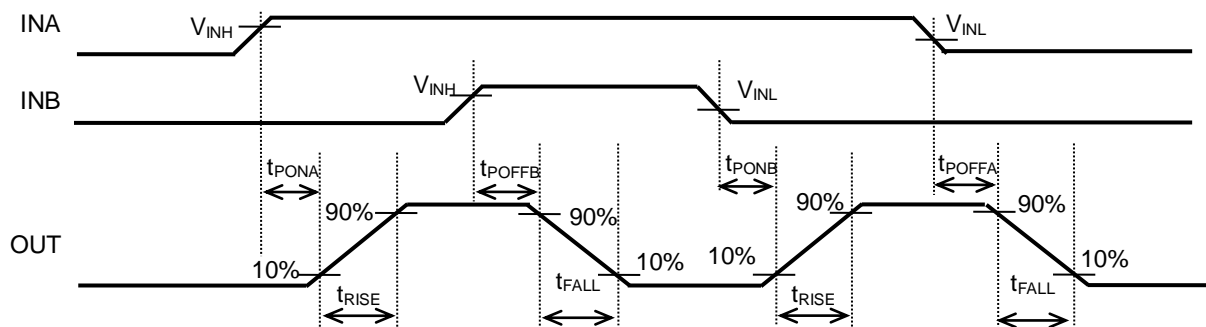

Figure 6. Timing Chart of IN-OUT

Typical Performance Curves

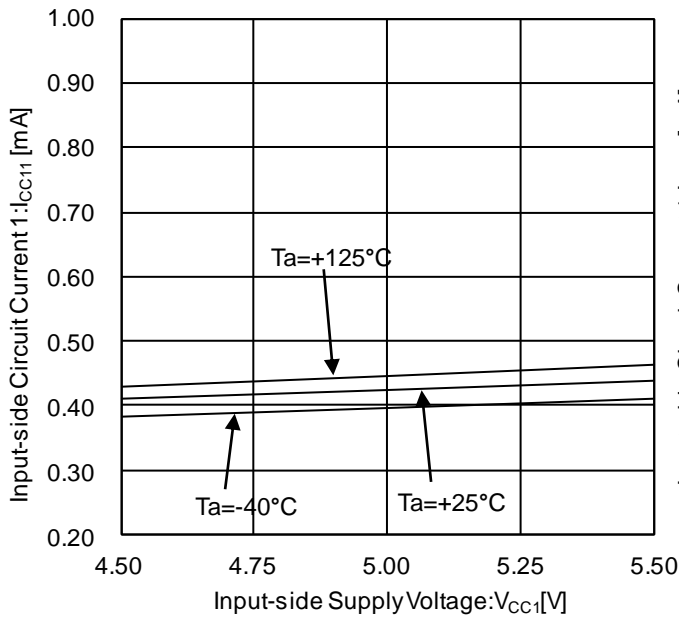

Figure 7. Input-side Circuit Current 1 vs Input-side Supply Voltage

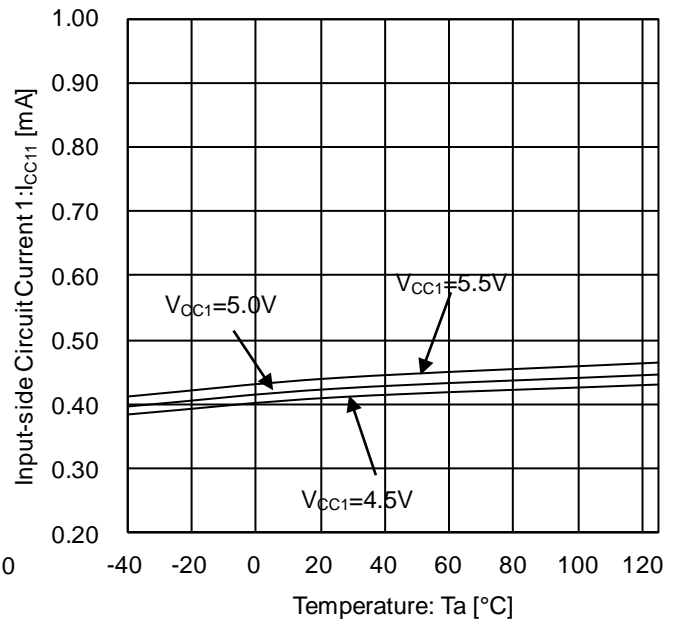

Figure 8. Input-side Circuit Current 1 vs Temperature

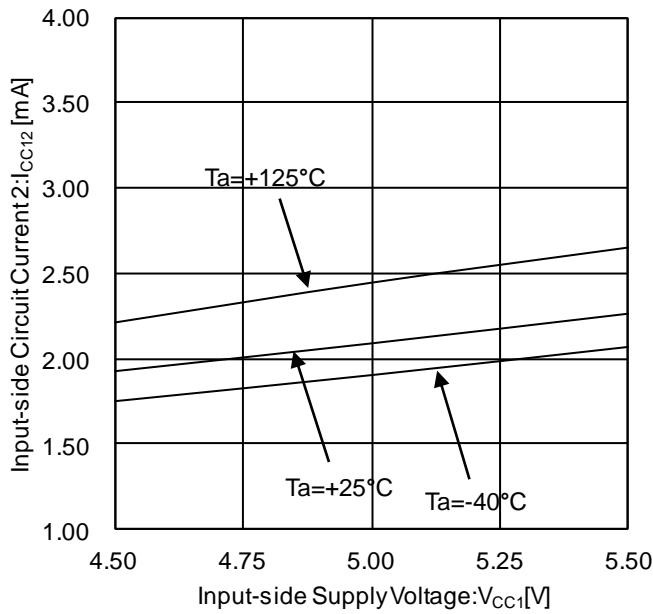

Figure 9. Input-side Circuit Current 2 vs Input-side Supply Voltage (At $I_{NA}=100\text{ kHz}$, Duty=50 %)

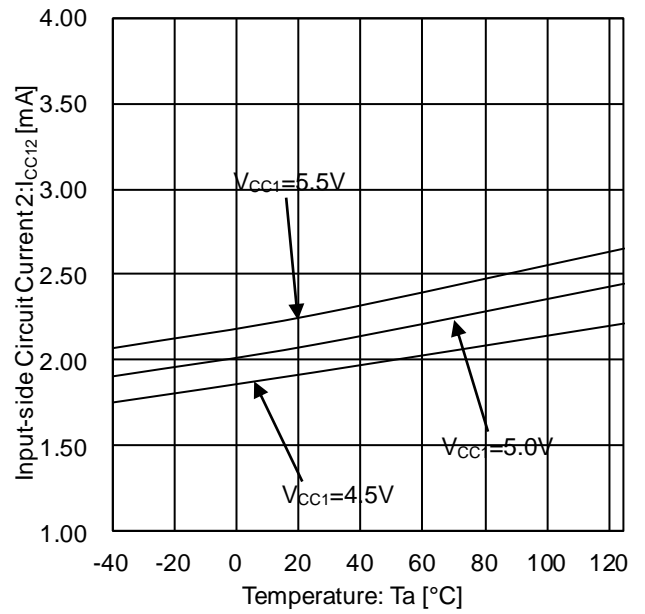

Figure 10. Input-side Circuit Current 2 vs Temperature (At $I_{NA}=100\text{ kHz}$, Duty=50 %)

Typical Performance Curves - continued

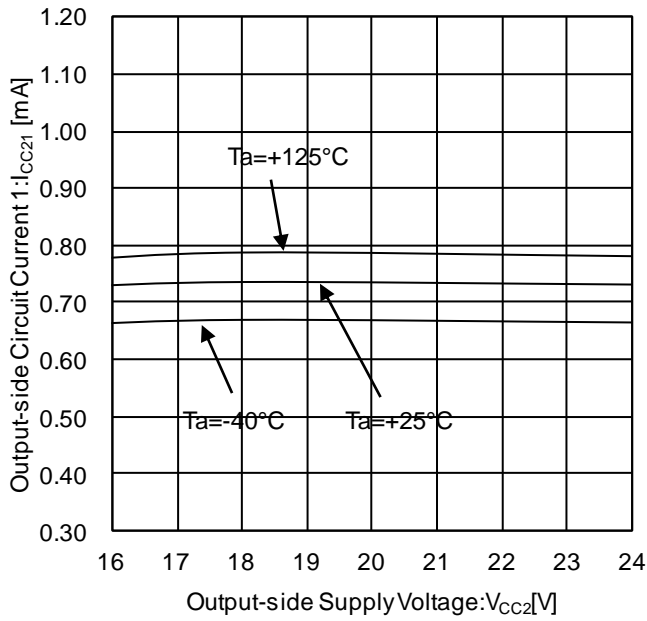

Figure 11. Output-side Circuit Current 1 vs Output-side Supply Voltage (At $OUT=L$)

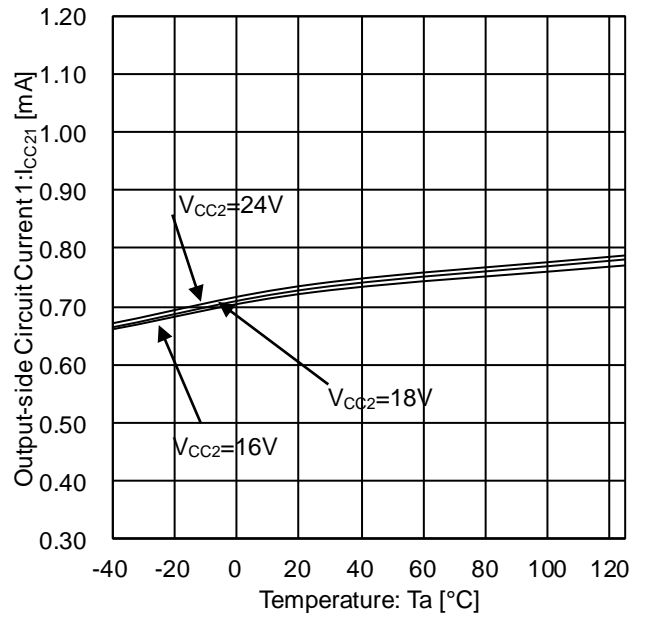

Figure 12. Output-side Circuit Current 1 vs Temperature (At $OUT=L$)

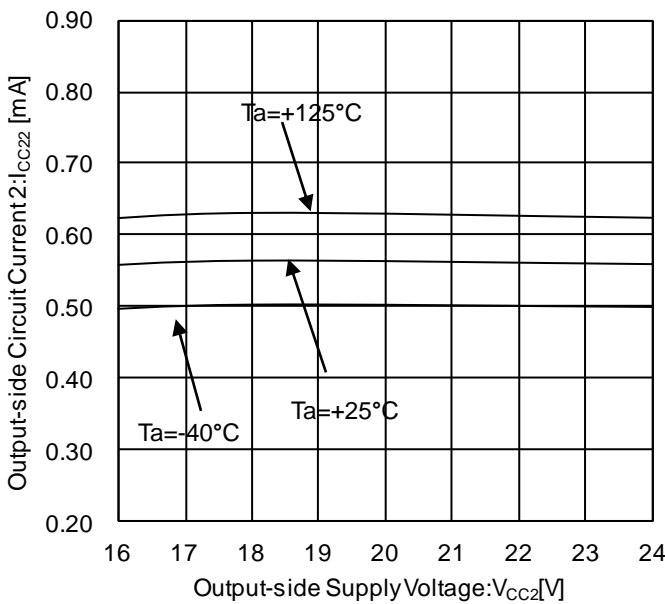

Figure 13. Output-side Circuit Current 2 vs Output-side Supply Voltage (At $OUT=H$)

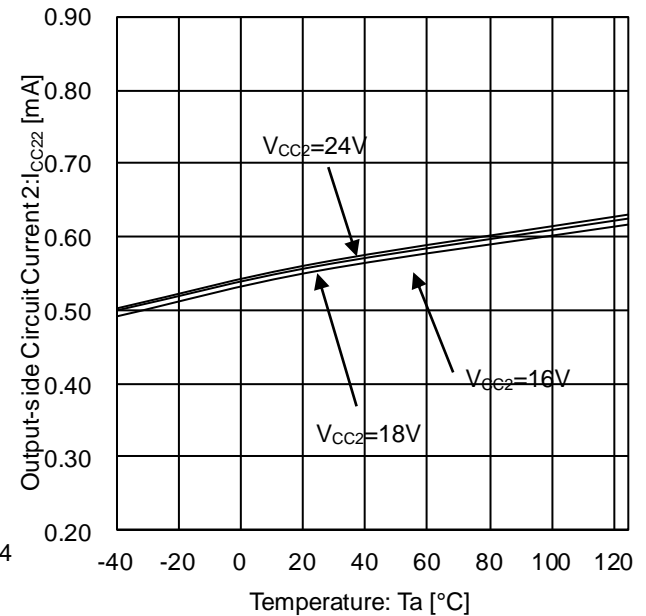

Figure 14. Output-side Circuit Current 2 vs Temperature (At $OUT=H$)

Typical Performance Curves - continued

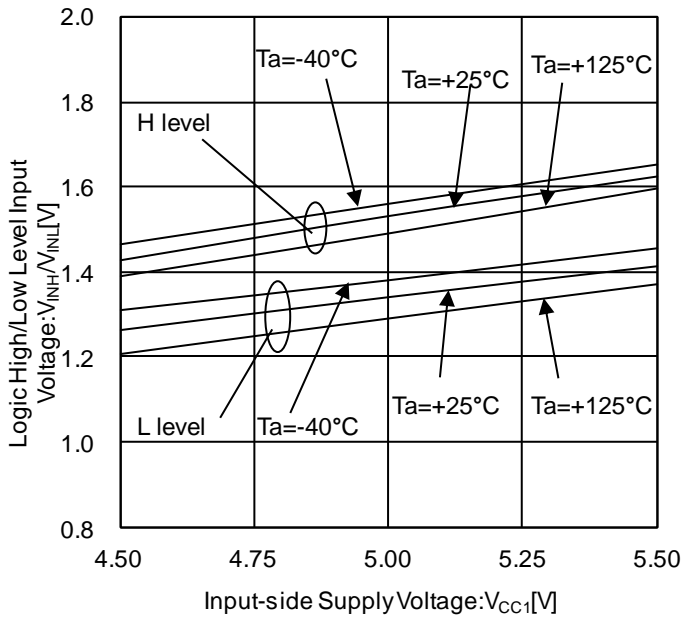

Figure 15. Logic High/Low Level Input Voltage vs Input-side Supply Voltage

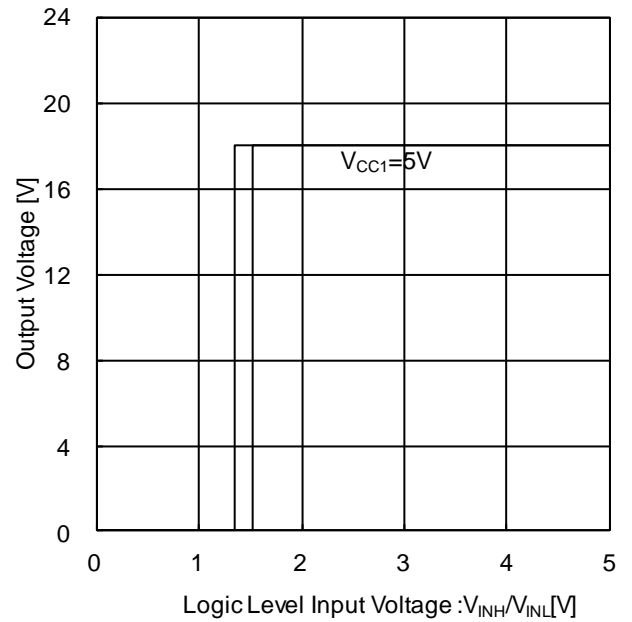

Figure 16 Output Voltage vs Logic Level Input Voltage (INA)
(V_{CC1}=5 V, V_{CC2}=18 V, Ta=25 °C)

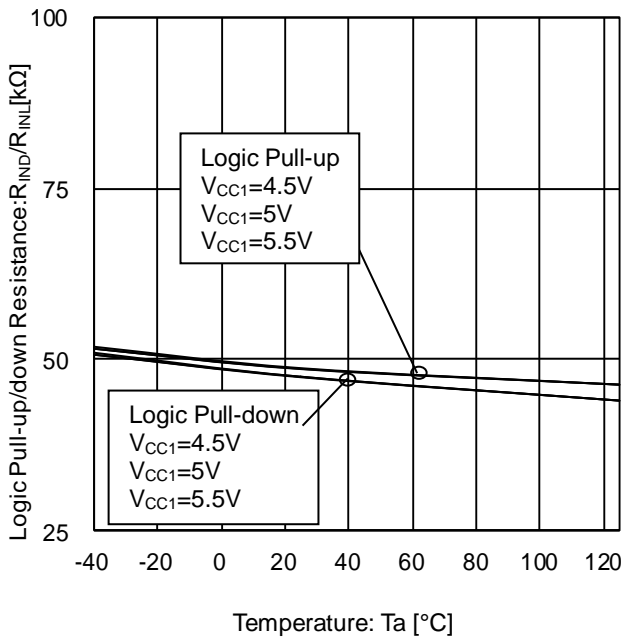

Figure 17. Logic Pull-up/down Resistance vs Temperature

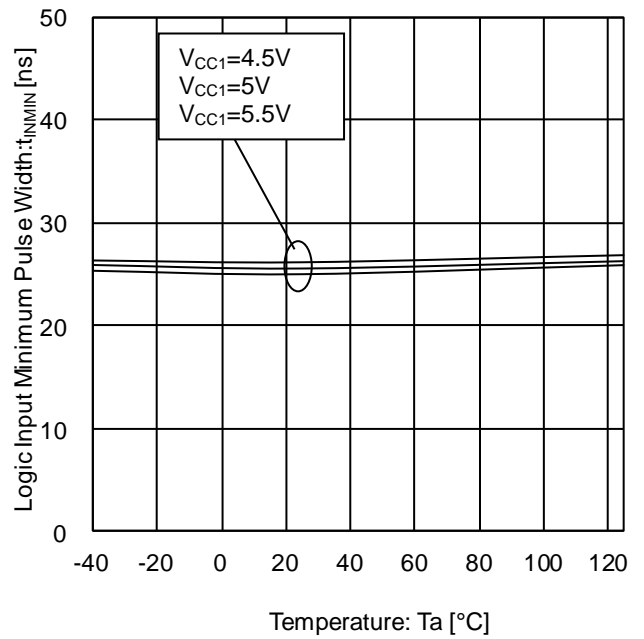

Figure 18. Logic Input Minimum Pulse Width vs Temperature

Typical Performance Curves - continued

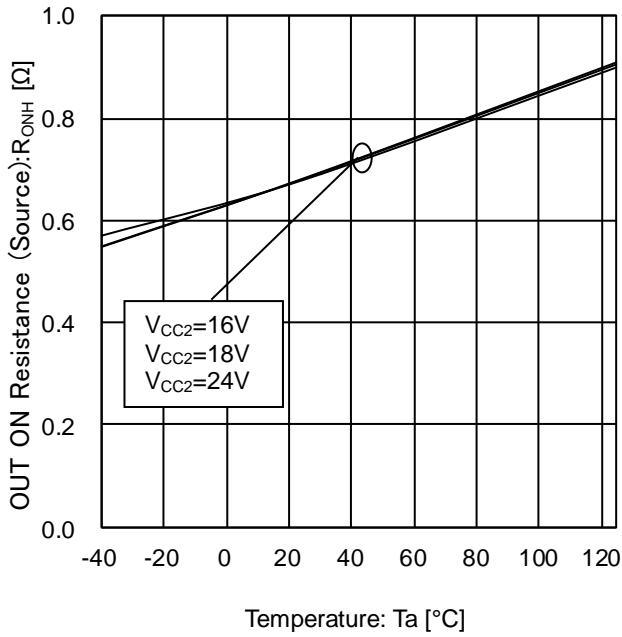

Figure 19. OUT ON Resistance (Source) vs Temperature

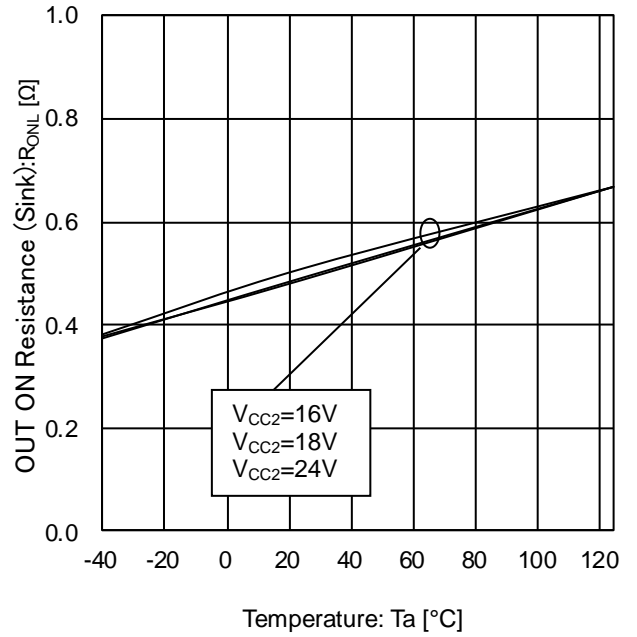

Figure 20. OUT ON Resistance (Sink) vs Temperature

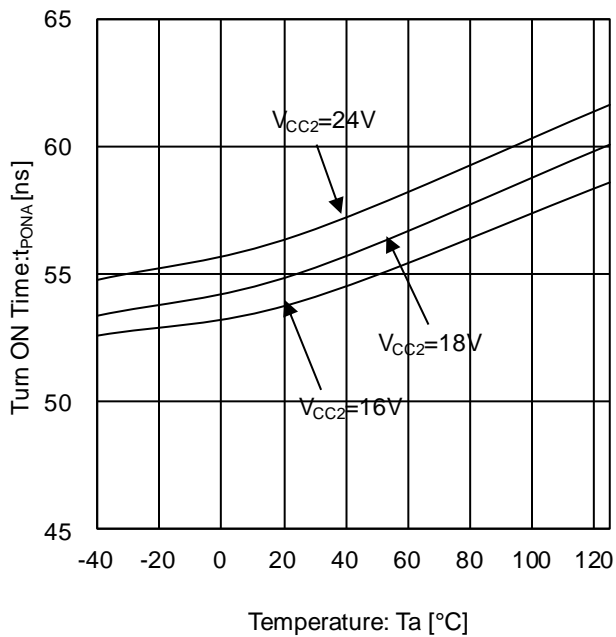

Figure 21. Turn ON Time vs Temperature (INA=PWM, INB=L)

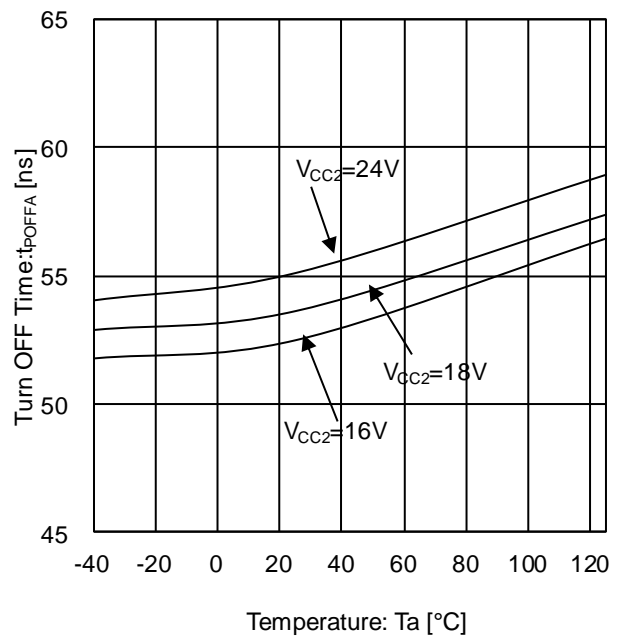

Figure 22. Turn OFF Time vs Temperature (INA=PWM, INB=L)

Typical Performance Curves - continued

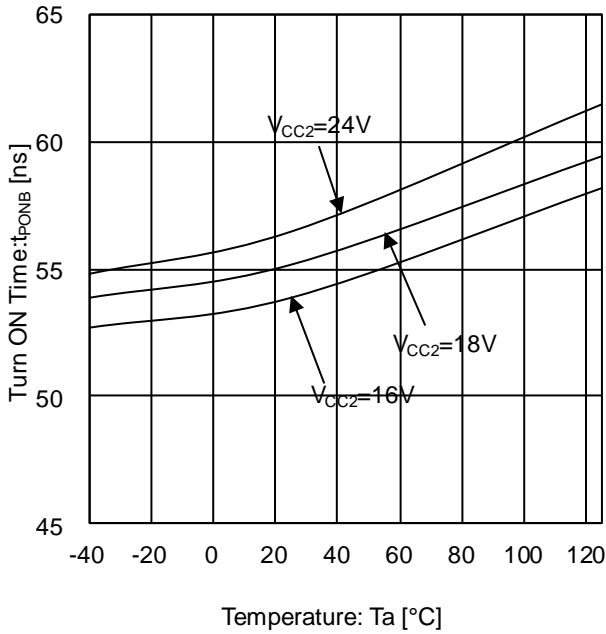

Figure 23. Turn ON Time vs Temperature (INA=H, INB=PWM)

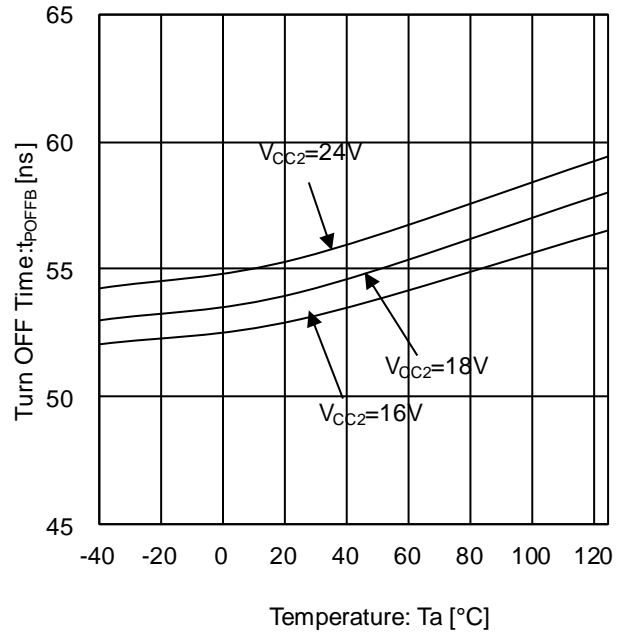

Figure 24. Turn OFF Time vs Temperature (INA=H, INB=PWM)

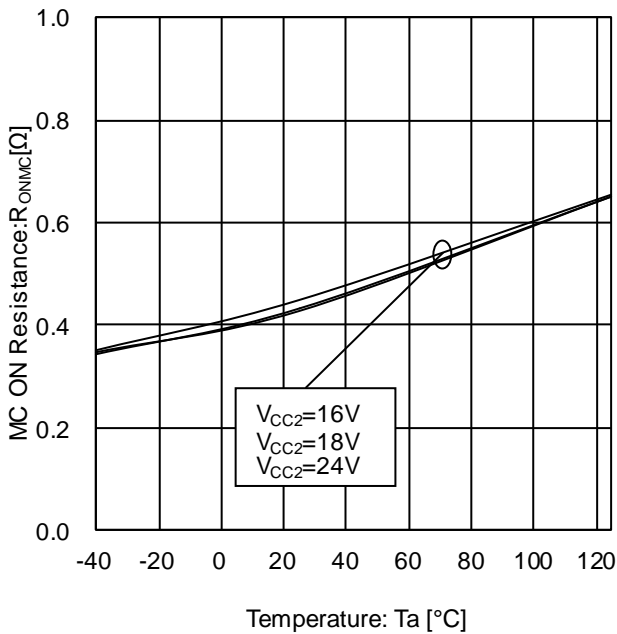

Figure 25. MC ON Resistance vs Temperature

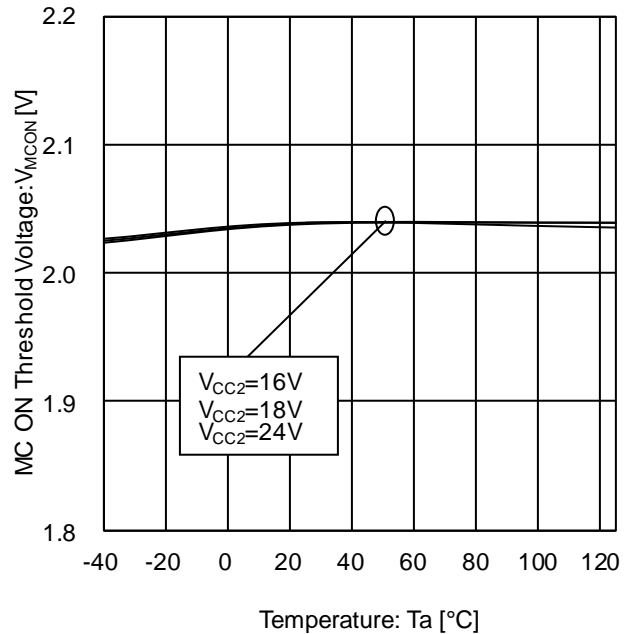

Figure 26. MC ON Threshold Voltage vs Temperature

Typical Performance Curves - continued

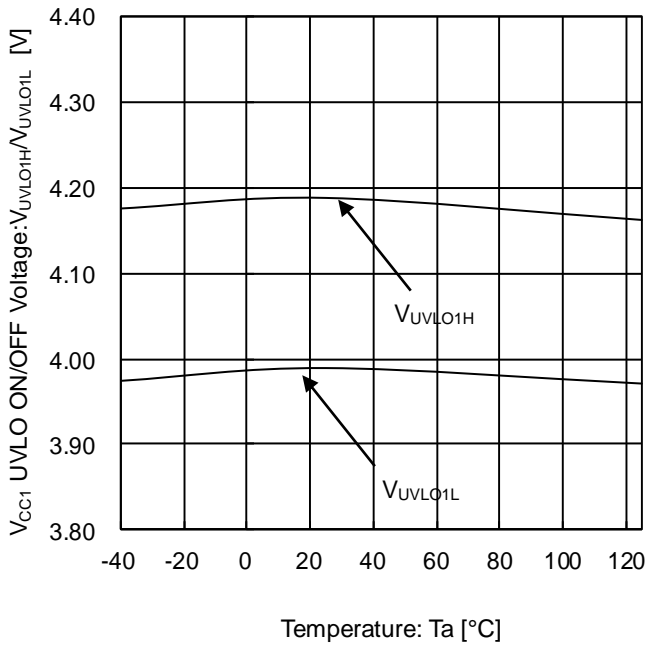

Figure 27. V_{CC1} UVLO ON/OFF Voltage vs Temperature

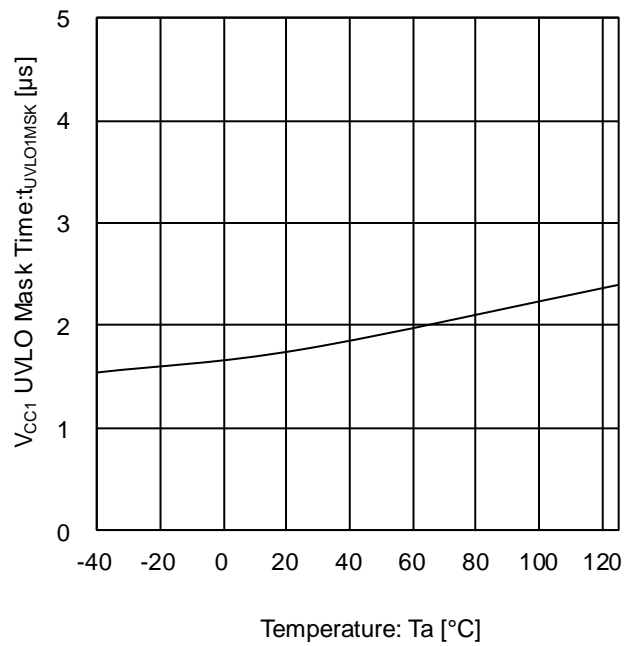

Figure 28. V_{CC1} UVLO Mask Time vs Temperature

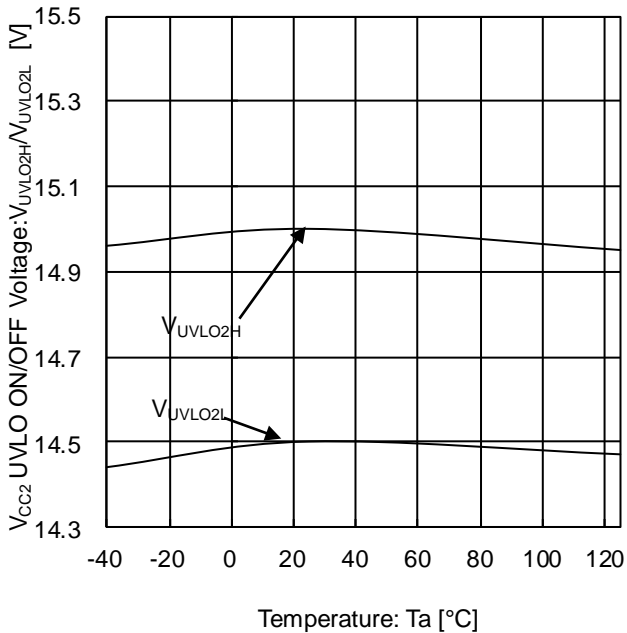

Figure 29. V_{CC2} UVLO ON/OFF Voltage vs Temperature

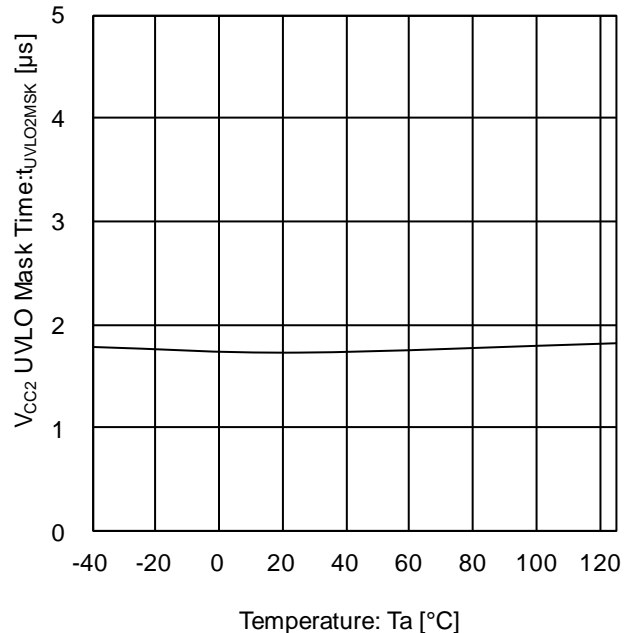

Figure 30. V_{CC2} UVLO Mask Time vs Temperature

Application Examples

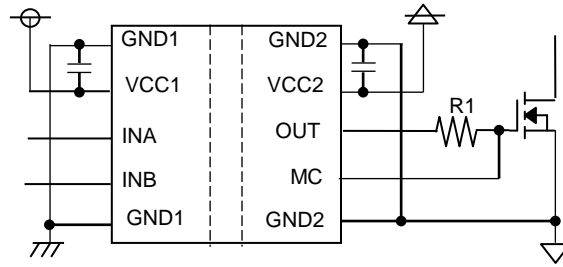

Figure 31. Driving SiC

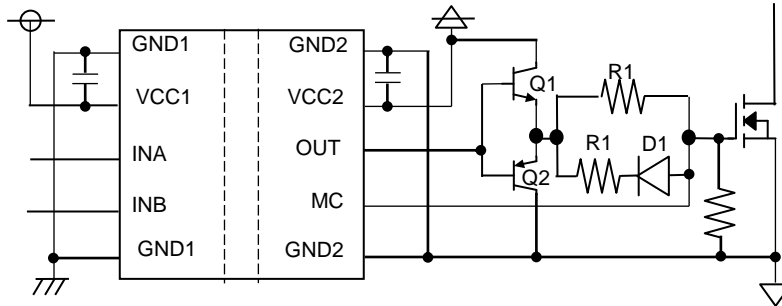

Figure 32. Driving SiC with Buffer Circuit

Recommended Parts

	Manufacturer	Element	Part Number
R1	ROHM	Resistor	LTR18EZP,LTR50UZP
Q1	ROHM	NPN Transistor	2SCR542PFRA
Q2	ROHM	PNP Transistor	2SAR542PFRA
D1	ROHM	Diode	RBR3MM30ATF,RBR5LAM30ATF

I/O Equivalence Circuits

Pin No.	Pin Name	I/O Equivalence Circuits
	Function	
3	OUT	
	Output Pin	
2	MC	
	Miller Clamp pin	
8	INA	
	Control Input A pin	
9	INB	
	Control Input B pin	

Operational Notes

1. Reverse Connection of Power Supply

Connecting the power supply in reverse polarity can damage the IC. Take precautions against reverse polarity when connecting the power supply, such as mounting an external diode between the power supply and the IC's power supply pins.

2. Power Supply Lines

Design the PCB layout pattern to provide low impedance supply lines. Separate the ground and supply lines of the digital and analog blocks to prevent noise in the ground and supply lines of the digital block from affecting the analog block. Furthermore, connect a capacitor to ground at all power supply pins. Consider the effect of temperature and aging on the capacitance value when using electrolytic capacitors.

3. Ground Voltage

Ensure that no pins are at a voltage below that of the ground pin at any time, even during transient condition.

4. Ground Wiring Pattern

When using both small-signal and large-current ground traces, the two ground traces should be routed separately but connected to a single ground at the reference point of the application board to avoid fluctuations in the small-signal ground caused by large currents. Also ensure that the ground traces of external components do not cause variations on the ground voltage. The ground lines must be as short and thick as possible to reduce line impedance.

5. Recommended Operating Conditions

The function and operation of the IC are guaranteed within the range specified by the recommended operating conditions. The characteristic values are guaranteed only under the conditions of each item specified by the electrical characteristics.

6. Inrush Current

When power is first supplied to the IC, it is possible that the internal logic may be unstable and inrush current may flow instantaneously due to the internal powering sequence and delays, especially if the IC has more than one power supply. Therefore, give special consideration to power coupling capacitance, power wiring, width of ground wiring, and routing of connections.

7. Testing on Application Boards

When testing the IC on an application board, connecting a capacitor directly to a low-impedance output pin may subject the IC to stress. Always discharge capacitors completely after each process or step. The IC's power supply should always be turned off completely before connecting or removing it from the test setup during the inspection process. To prevent damage from static discharge, ground the IC during assembly and use similar precautions during transport and storage.

8. Inter-pin Short and Mounting Errors

Ensure that the direction and position are correct when mounting the IC on the PCB. Incorrect mounting may result in damaging the IC. Avoid nearby pins being shorted to each other especially to ground, power supply and output pin. Inter-pin shorts could be due to many reasons such as metal particles, water droplets (in very humid environment) and unintentional solder bridge deposited in between pins during assembly to name a few.

Operational Notes – continued

9. Unused Input Pins

Input pins of an IC are often connected to the gate of a MOS transistor. The gate has extremely high impedance and extremely low capacitance. If left unconnected, the electric field from the outside can easily charge it. The small charge acquired in this way is enough to produce a significant effect on the conduction through the transistor and cause unexpected operation of the IC. So unless otherwise specified, unused input pins should be connected to the power supply or ground line.

10. Regarding the Input Pin of the IC

This IC contains P+ isolation and P substrate layers between adjacent elements in order to keep them isolated. P-N junctions are formed at the intersection of the P layers with the N layers of other elements, creating a parasitic diode or transistor. For example (refer to figure below):

When GND > Pin A and GND > Pin B, the P-N junction operates as a parasitic diode.
 When GND > Pin B, the P-N junction operates as a parasitic transistor.

Parasitic diodes inevitably occur in the structure of the IC. The operation of parasitic diodes can result in mutual interference among circuits, operational faults, or physical damage. Therefore, conditions that cause these diodes to operate, such as applying a voltage lower than the GND voltage to an input pin (and thus to the P substrate) should be avoided.

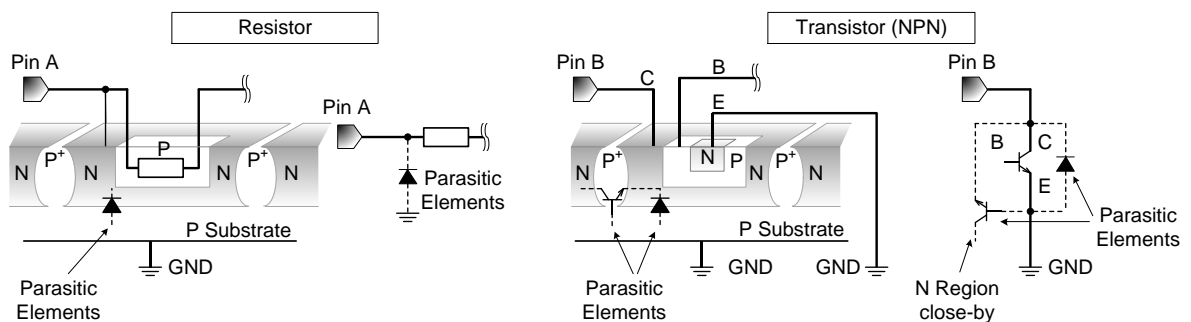
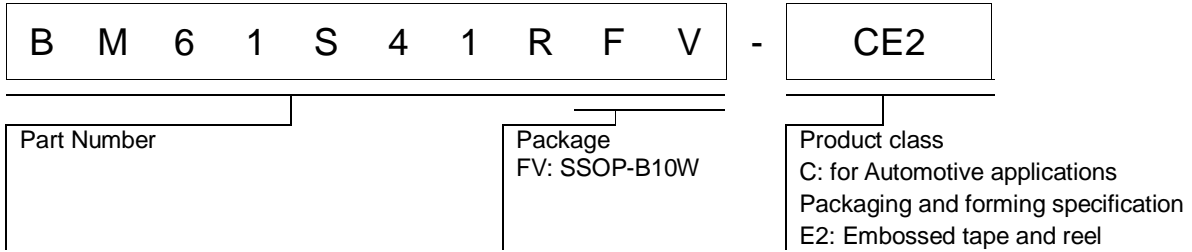

Figure 33. Example of IC structure

11. Ceramic Capacitor

When using a ceramic capacitor, determine a capacitance value considering the change of capacitance with temperature and the decrease in nominal capacitance due to DC bias and others.

Ordering Information



Marking Diagram

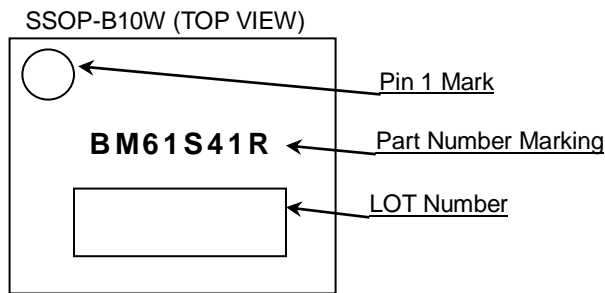

Physical Dimension and Packing Information

Package Name	SSOP-B10W
--------------	-----------

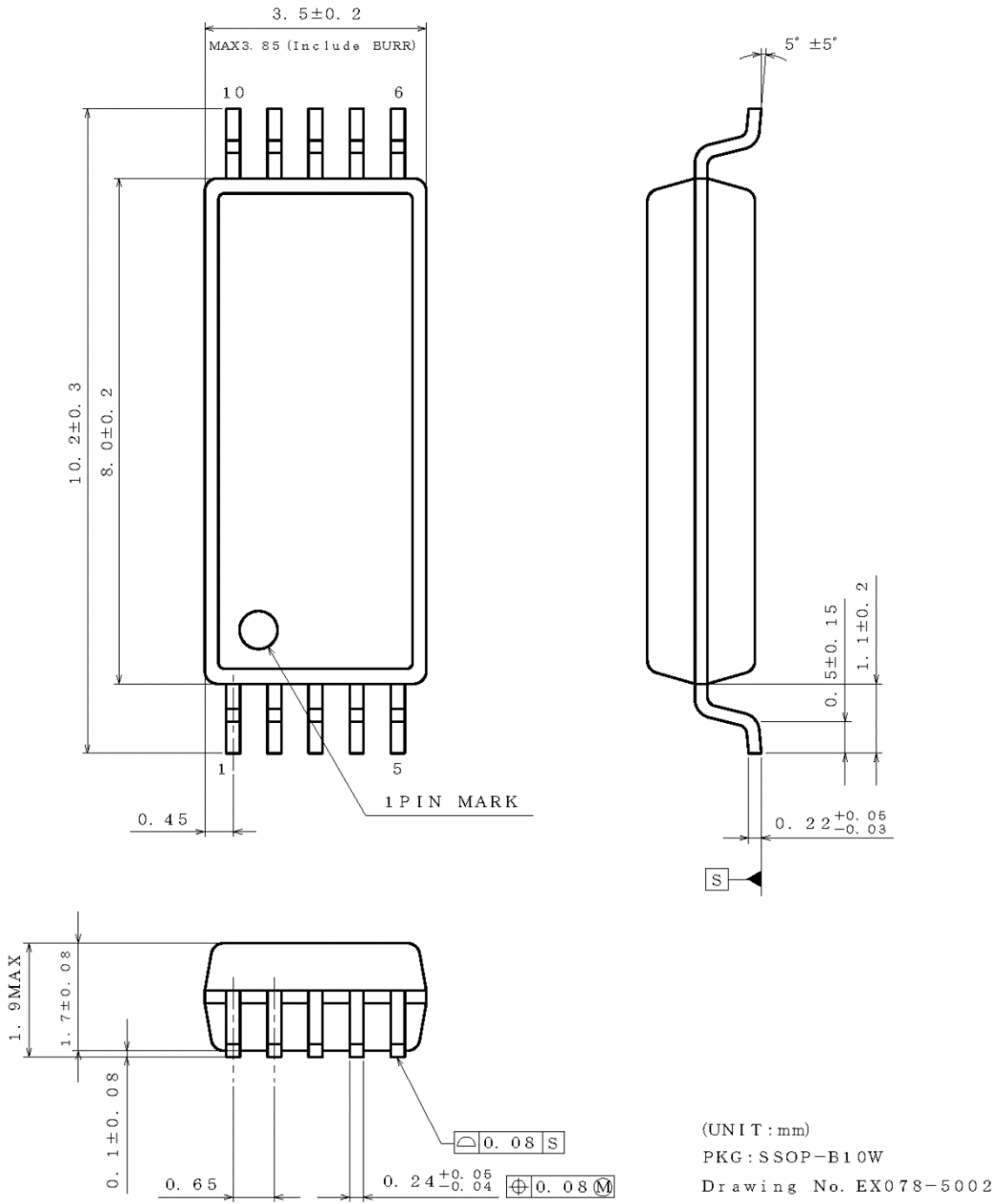

< Tape and Reel Information >

Tape	Embossed carrier tape (with dry pack)
Quantity	1500pcs
Direction of feed	E2 The direction is the pin 1 of product is at the upper left when you hold reel on the left hand and you pull out the tape on the right hand

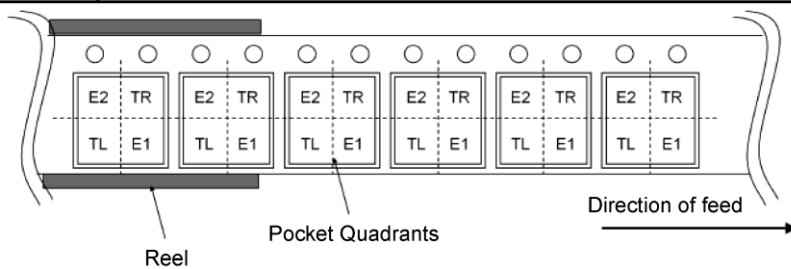

Revision History

Date	Revision	Changes
15.Jun.2018	001	New Release

Notice

Precaution on using ROHM Products

1. If you intend to use our Products in devices requiring extremely high reliability (such as medical equipment ^(Note 1), aircraft/spacecraft, nuclear power controllers, etc.) and whose malfunction or failure may cause loss of human life, bodily injury or serious damage to property ("Specific Applications"), please consult with the ROHM sales representative in advance. Unless otherwise agreed in writing by ROHM in advance, ROHM shall not be in any way responsible or liable for any damages, expenses or losses incurred by you or third parties arising from the use of any ROHM's Products for Specific Applications.

(Note1) Medical Equipment Classification of the Specific Applications

JAPAN	USA	EU	CHINA
CLASS III	CLASS III	CLASS II b	CLASS III
CLASS IV		CLASS III	

2. ROHM designs and manufactures its Products subject to strict quality control system. However, semiconductor products can fail or malfunction at a certain rate. Please be sure to implement, at your own responsibilities, adequate safety measures including but not limited to fail-safe design against the physical injury, damage to any property, which a failure or malfunction of our Products may cause. The following are examples of safety measures:
 - [a] Installation of protection circuits or other protective devices to improve system safety
 - [b] Installation of redundant circuits to reduce the impact of single or multiple circuit failure
3. Our Products are not designed under any special or extraordinary environments or conditions, as exemplified below. Accordingly, ROHM shall not be in any way responsible or liable for any damages, expenses or losses arising from the use of any ROHM's Products under any special or extraordinary environments or conditions. If you intend to use our Products under any special or extraordinary environments or conditions (as exemplified below), your independent verification and confirmation of product performance, reliability, etc. prior to use, must be necessary:
 - [a] Use of our Products in any types of liquid, including water, oils, chemicals, and organic solvents
 - [b] Use of our Products outdoors or in places where the Products are exposed to direct sunlight or dust
 - [c] Use of our Products in places where the Products are exposed to sea wind or corrosive gases, including Cl₂, H₂S, NH₃, SO₂, and NO₂
 - [d] Use of our Products in places where the Products are exposed to static electricity or electromagnetic waves
 - [e] Use of our Products in proximity to heat-producing components, plastic cords, or other flammable items
 - [f] Sealing or coating our Products with resin or other coating materials
 - [g] Use of our Products without cleaning residue of flux (even if you use no-clean type fluxes, cleaning residue of flux is recommended); or Washing our Products by using water or water-soluble cleaning agents for cleaning residue after soldering
 - [h] Use of the Products in places subject to dew condensation
4. The Products are not subject to radiation-proof design.
5. Please verify and confirm characteristics of the final or mounted products in using the Products.
6. In particular, if a transient load (a large amount of load applied in a short period of time, such as pulse. is applied, confirmation of performance characteristics after on-board mounting is strongly recommended. Avoid applying power exceeding normal rated power; exceeding the power rating under steady-state loading condition may negatively affect product performance and reliability.
7. De-rate Power Dissipation depending on ambient temperature. When used in sealed area, confirm that it is the use in the range that does not exceed the maximum junction temperature.
8. Confirm that operation temperature is within the specified range described in the product specification.
9. ROHM shall not be in any way responsible or liable for failure induced under deviant condition from what is defined in this document.

Precaution for Mounting / Circuit board design

1. When a highly active halogenous (chlorine, bromine, etc.) flux is used, the residue of flux may negatively affect product performance and reliability.
2. In principle, the reflow soldering method must be used on a surface-mount products, the flow soldering method must be used on a through hole mount products. If the flow soldering method is preferred on a surface-mount products, please consult with the ROHM representative in advance.

For details, please refer to ROHM Mounting specification

Precautions Regarding Application Examples and External Circuits

1. If change is made to the constant of an external circuit, please allow a sufficient margin considering variations of the characteristics of the Products and external components, including transient characteristics, as well as static characteristics.
2. You agree that application notes, reference designs, and associated data and information contained in this document are presented only as guidance for Products use. Therefore, in case you use such information, you are solely responsible for it and you must exercise your own independent verification and judgment in the use of such information contained in this document. ROHM shall not be in any way responsible or liable for any damages, expenses or losses incurred by you or third parties arising from the use of such information.

Precaution for Electrostatic

This Product is electrostatic sensitive product, which may be damaged due to electrostatic discharge. Please take proper caution in your manufacturing process and storage so that voltage exceeding the Products maximum rating will not be applied to Products. Please take special care under dry condition (e.g. Grounding of human body / equipment / solder iron, isolation from charged objects, setting of Ionizer, friction prevention and temperature / humidity control).

Precaution for Storage / Transportation

1. Product performance and soldered connections may deteriorate if the Products are stored in the places where:
 - [a] the Products are exposed to sea winds or corrosive gases, including Cl₂, H₂S, NH₃, SO₂, and NO₂
 - [b] the temperature or humidity exceeds those recommended by ROHM
 - [c] the Products are exposed to direct sunshine or condensation
 - [d] the Products are exposed to high Electrostatic
2. Even under ROHM recommended storage condition, solderability of products out of recommended storage time period may be degraded. It is strongly recommended to confirm solderability before using Products of which storage time is exceeding the recommended storage time period.
3. Store / transport cartons in the correct direction, which is indicated on a carton with a symbol. Otherwise bent leads may occur due to excessive stress applied when dropping of a carton.
4. Use Products within the specified time after opening a humidity barrier bag. Baking is required before using Products of which storage time is exceeding the recommended storage time period.

Precaution for Product Label

A two-dimensional barcode printed on ROHM Products label is for ROHM's internal use only.

Precaution for Disposition

When disposing Products please dispose them properly using an authorized industry waste company.

Precaution for Foreign Exchange and Foreign Trade act

Since concerned goods might be fallen under listed items of export control prescribed by Foreign exchange and Foreign trade act, please consult with ROHM in case of export.

Precaution Regarding Intellectual Property Rights

1. All information and data including but not limited to application example contained in this document is for reference only. ROHM does not warrant that foregoing information or data will not infringe any intellectual property rights or any other rights of any third party regarding such information or data.
2. ROHM shall not have any obligations where the claims, actions or demands arising from the combination of the Products with other articles such as components, circuits, systems or external equipment (including software).
3. No license, expressly or implied, is granted hereby under any intellectual property rights or other rights of ROHM or any third parties with respect to the Products or the information contained in this document. Provided, however, that ROHM will not assert its intellectual property rights or other rights against you or your customers to the extent necessary to manufacture or sell products containing the Products, subject to the terms and conditions herein.

Other Precaution

1. This document may not be reprinted or reproduced, in whole or in part, without prior written consent of ROHM.
2. The Products may not be disassembled, converted, modified, reproduced or otherwise changed without prior written consent of ROHM.
3. In no event shall you use in any way whatsoever the Products and the related technical information contained in the Products or this document for any military purposes, including but not limited to, the development of mass-destruction weapons.
4. The proper names of companies or products described in this document are trademarks or registered trademarks of ROHM, its affiliated companies or third parties.

General Precaution

1. Before you use our Products, you are requested to carefully read this document and fully understand its contents. ROHM shall not be in any way responsible or liable for failure, malfunction or accident arising from the use of any ROHM's Products against warning, caution or note contained in this document.
2. All information contained in this document is current as of the issuing date and subject to change without any prior notice. Before purchasing or using ROHM's Products, please confirm the latest information with a ROHM sales representative.
3. The information contained in this document is provided on an "as is" basis and ROHM does not warrant that all information contained in this document is accurate and/or error-free. ROHM shall not be in any way responsible or liable for any damages, expenses or losses incurred by you or third parties resulting from inaccuracy or errors of or concerning such information.



BM61S41RFV-C - Web Page

[Distribution Inventory](#)

Part Number	BM61S41RFV-C
Package	SSOP-B10W
Unit Quantity	1500
Minimum Package Quantity	1500
Packing Type	Taping
Constitution Materials List	inquiry
RoHS	Yes