

P-Channel Enhancement Mode MOSFET

Features

- -30V/-5.3A ,
 $R_{DS(ON)} = 65m\Omega(\text{typ.}) @ V_{GS} = -10V$
 $R_{DS(ON)} = 100m\Omega(\text{typ.}) @ V_{GS} = -4.5V$
- Super High Dense Cell Design
- Reliable and Rugged
- Lead Free Available (RoHS Compliant)

Applications

- Power Management in Notebook Computer, Portable Equipment and Battery Powered Systems ; **LCD-TV ; LCD-monitor ; Net-card**

Pin Description

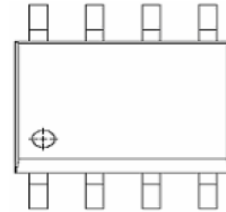

1	2	3	4
S	S	S	G

Top View of SOP – 8

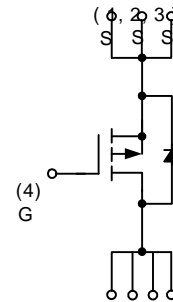

D D D
(5,6,7,8)

P-Channel MOSFET

BM reserves the right to make changes to improve reliability or manufacturability without notice, and advise customers to obtain the latest version of relevant information to verify before placing orders.

Absolute Maximum Ratings ($T_A = 25^\circ\text{C}$ unless otherwise noted)

Symbol	Parameter	Rating	Unit	
V_{DSS}	Drain-Source Voltage	-30	V	
V_{GSS}	Gate-Source Voltage	± 25		
I_D^*	Continuous Drain Current	$V_{GS} = -10\text{V}$ -5.3	A	
I_{DM}^*	Pulsed Drain Current			-20
I_S^*	Diode Continuous Forward Current	-2	A	
T_J	Maximum Junction Temperature	150	$^\circ\text{C}$	
T_{STG}	Storage Temperature Range	-55 to 150		
P_D^*	Maximum Power Dissipation	$T_A = 25^\circ\text{C}$	2	W
		$T_A = 100^\circ\text{C}$	0.8	
$R_{\theta JA}^*$	Thermal Resistance-Junction to Ambient	62.5	$^\circ\text{C/W}$	

Note:

*Surface Mounted on 1in^2 pad area, $t \leq 10\text{sec}$.

Electrical Characteristics ($T_A = 25^\circ\text{C}$ unless otherwise noted)

Symbol	Parameter	Test Condition	BM9435A			Unit
			Min.	Typ.	Max.	
Static Characteristics						
BV_{DSS}	Drain-Source Breakdown Voltage	$V_{GS} = 0\text{V}, I_{DS} = -250\mu\text{A}$	-30			V
I_{DSS}	Zero Gate Voltage Drain Current	$V_{DS} = -24\text{V}, V_{GS} = 0\text{V}$ $T_A = 25^\circ\text{C}$			-1	μA
					-30	
$V_{GS(th)}$	Gate Threshold Voltage	$V_{DS} = V_{GS}, I_{DS} = -250\mu\text{A}$	-1	-1.5	-2	V
I_{GSS}	Gate Leakage Current	$V_{GS} = \pm 25\text{V}, V_{DS} = 0\text{V}$			± 100	nA
$R_{DS(ON)}^a$	Drain-Source On-state Resistance	$V_{GS} = -10\text{V}, I_{DS} = -4.6\text{A}$			65	m Ω
		$V_{GS} = -4.5\text{V}, I_{DS} = -2\text{A}$			100	
V_{SD}^a	Diode Forward Voltage	$I_{SD} = -2\text{A}, V_{GS} = 0\text{V}$		-0.9	-1.3	V
Gate Charge Characteristics^b						
Q_g	Total Gate Charge	$V_{DS} = -15\text{V}, V_{GS} = -10\text{V},$ $I_{DS} = -5\text{A}$		27	32	nC
Q_{gs}	Gate-Source Charge			4		
Q_{gd}	Gate-Drain Charge			6.5		

Electrical Characteristics (Cont.) (T_A = 25°C unless otherwise noted)

Symbol	Parameter	Test Condition	BM9435A			Unit
			Min.	Typ.	Max.	
Dynamic Characteristics^b						
C _{iss}	Input Capacitance	V _{GS} =0V, V _{DS} =-15V, Frequency=1.0MHz		545		pF
C _{oss}	Output Capacitance			85		
C _{rss}	Reverse Transfer Capacitance			55		
t _{d(ON)}	Turn-on Delay Time	V _{DD} =-15V, R _L =15Ω, I _{DS} =-1A, V _{GEN} =-10V, R _G =6Ω			12	ns
T _r	Turn-on Rise Time			8	15	
t _{d(OFF)}	Turn-off Delay Time			25	46	
T _f	Turn-off Fall Time			5	10	
t _{rr}	Reverse Recovery Time	I _{DS} =-4.6A, dI _{SD} /dt=100A/μs		56		ns
Q _{rr}	Reverse Recovery Charge			30		nC

Notes:

- a : Pulse test ; pulse width≤300μs, duty cycle≤2%.
- b : Guaranteed by design, not subject to production testing.

Typical Characteristics

Power Dissipation

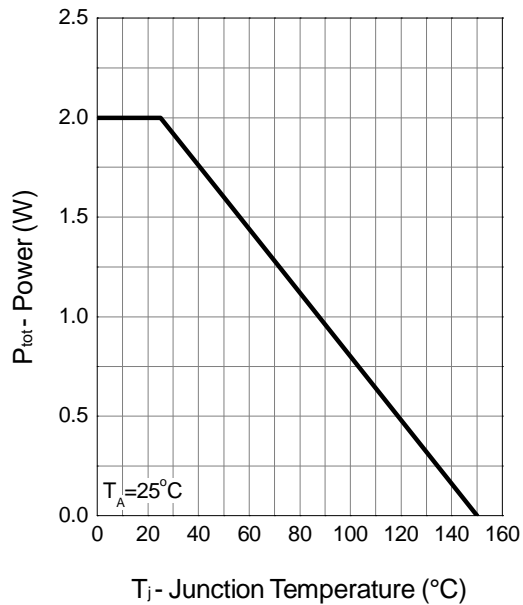

Drain Current

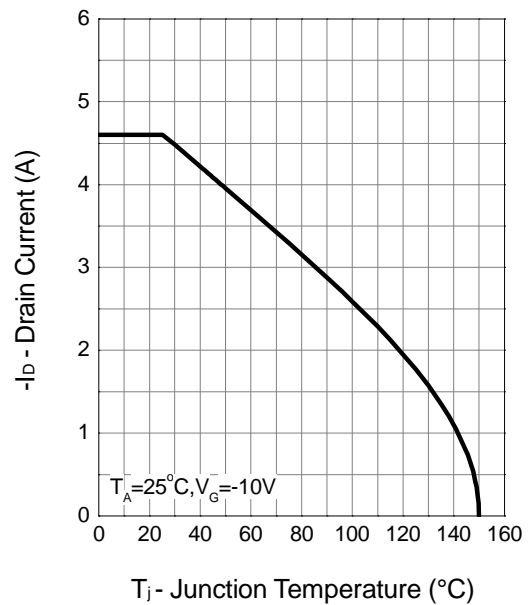

Safe Operation Area

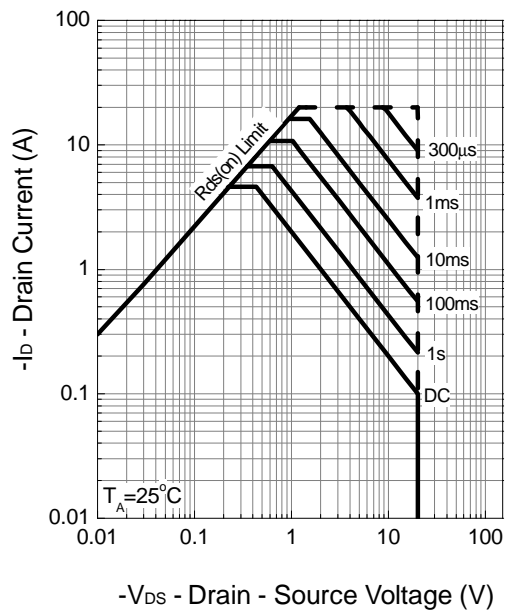

Thermal Transient Impedance

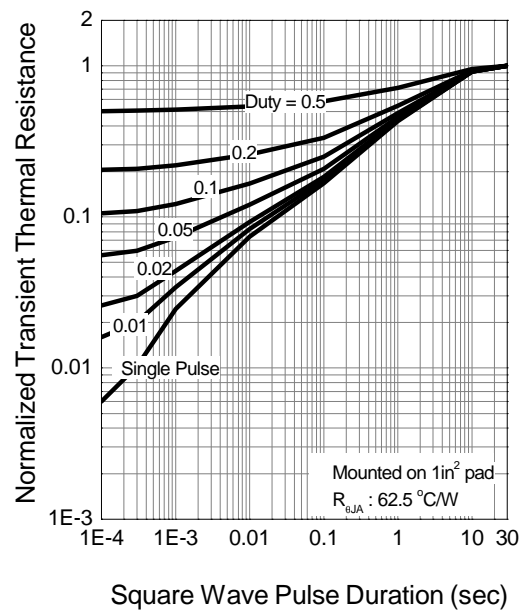

Typical Characteristics (Cont.)

Output Characteristics

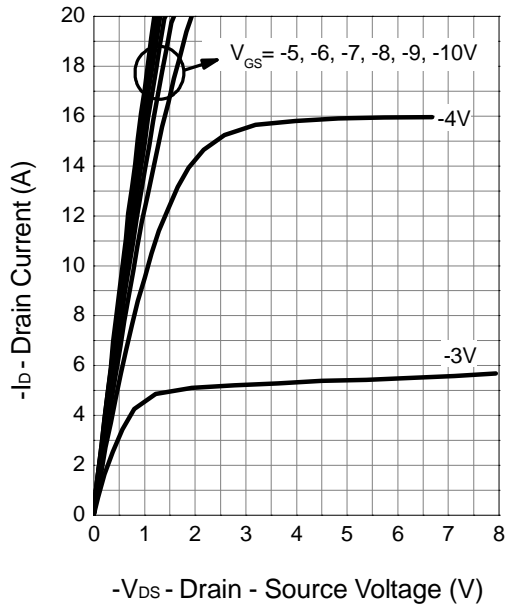

Drain-Source On Resistance

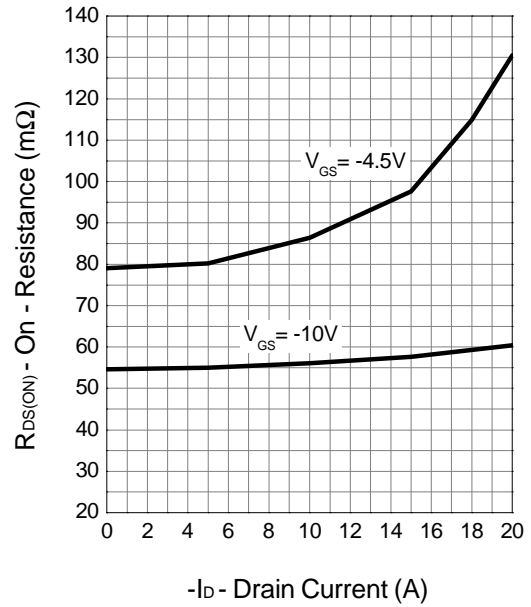

Transfer Characteristics

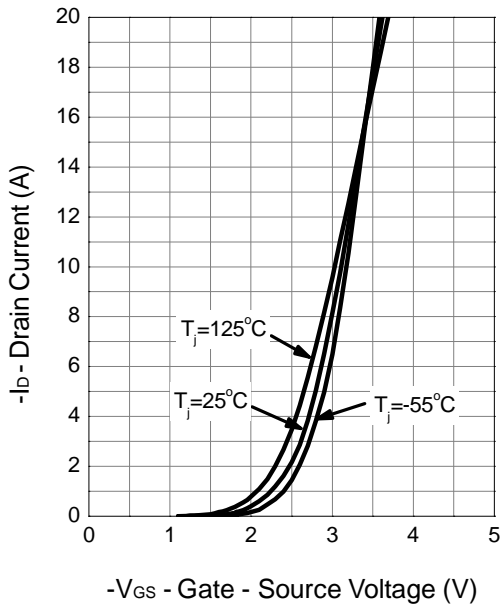

Gate Threshold Voltage

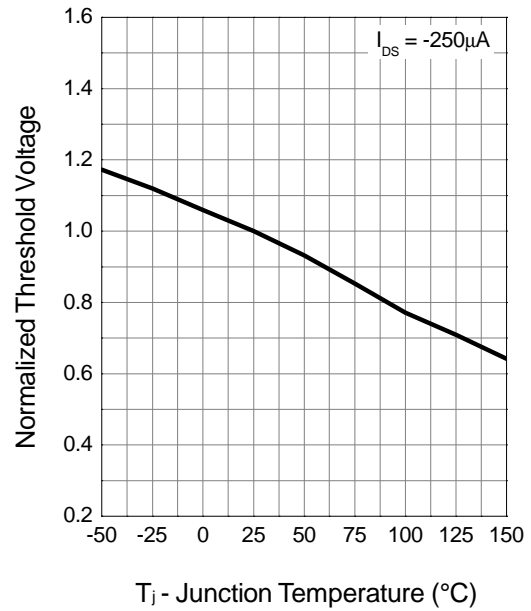

Typical Characteristics (Cont.)

Drain-Source On Resistance

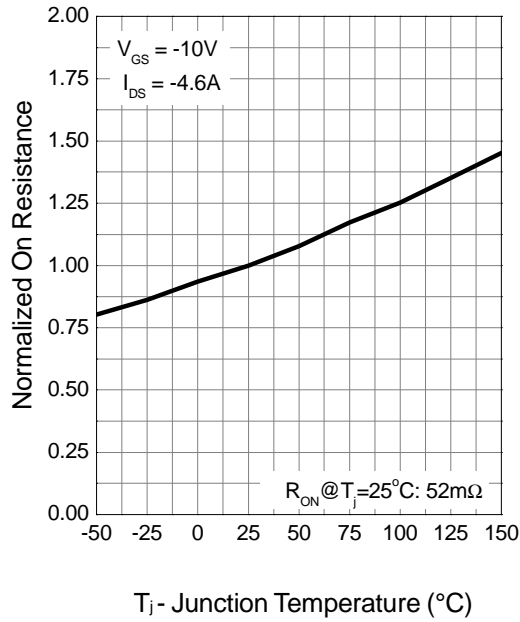

Source-Drain Diode Forward

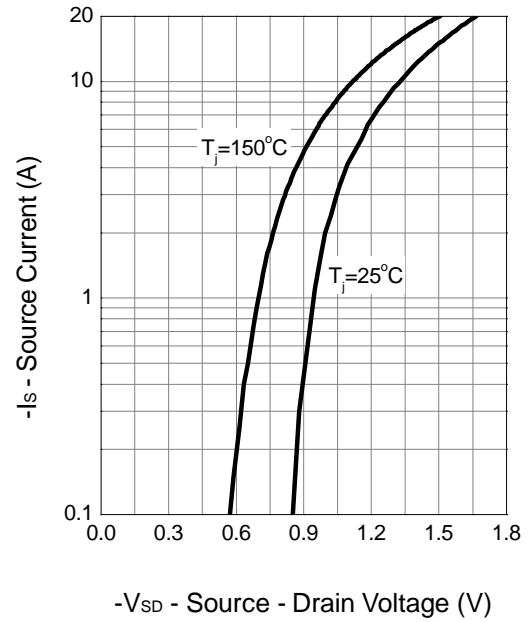

Capacitance

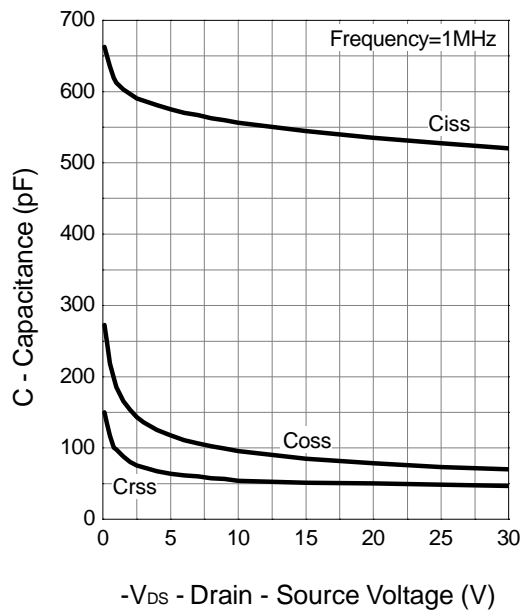

Gate Charge

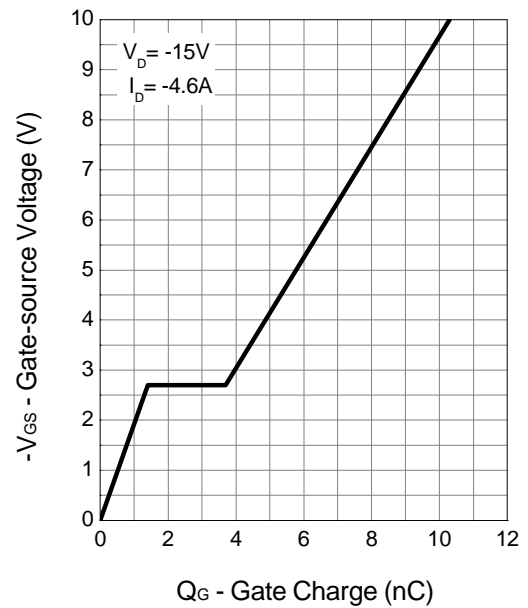

Packaging Information

SOP-8 pin (Reference JEDEC Registration MS-012)

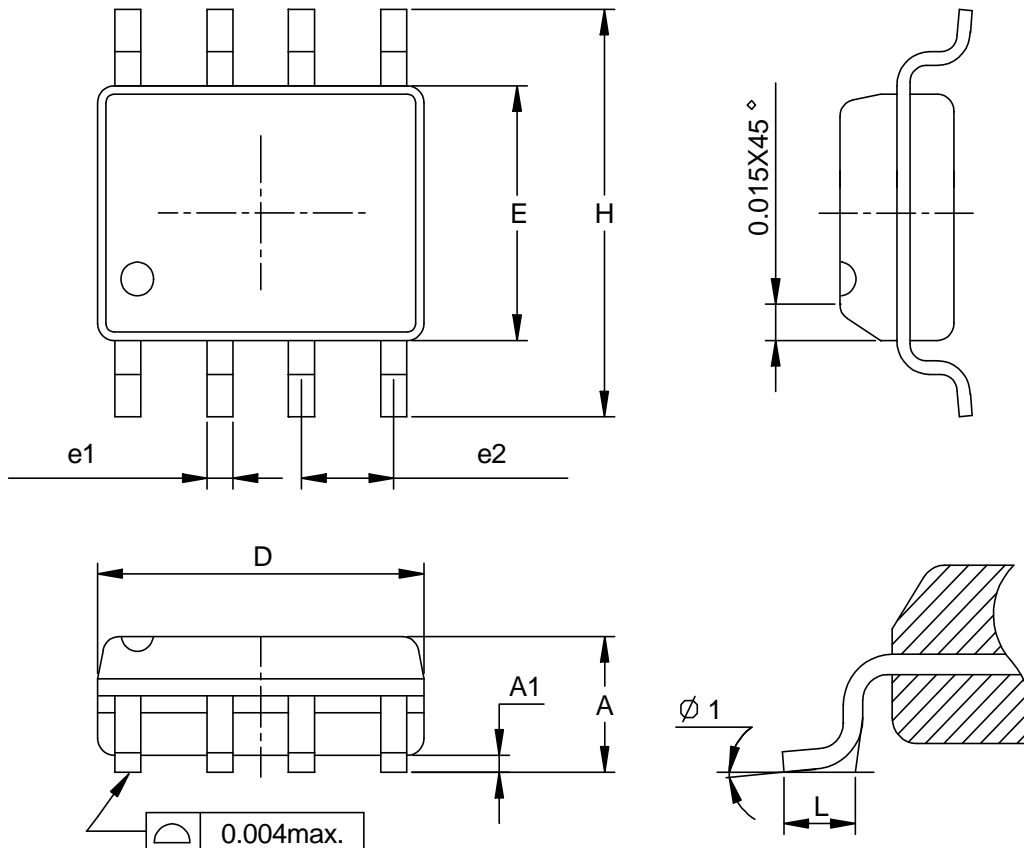

Dim	Millimeters		Inches	
	Min.	Max.	Min.	Max.
A	1.35	1.75	0.053	0.069
A1	0.10	0.25	0.004	0.010
D	4.80	5.00	0.189	0.197
E	3.80	4.00	0.150	0.157
H	5.80	6.20	0.228	0.244
L	0.40	1.27	0.016	0.050
e1	0.33	0.51	0.013	0.020
e2	1.27BSC		0.50BSC	
φ 1	0°	8°	0°	8°

Carrier Tape & Reel Dimensions

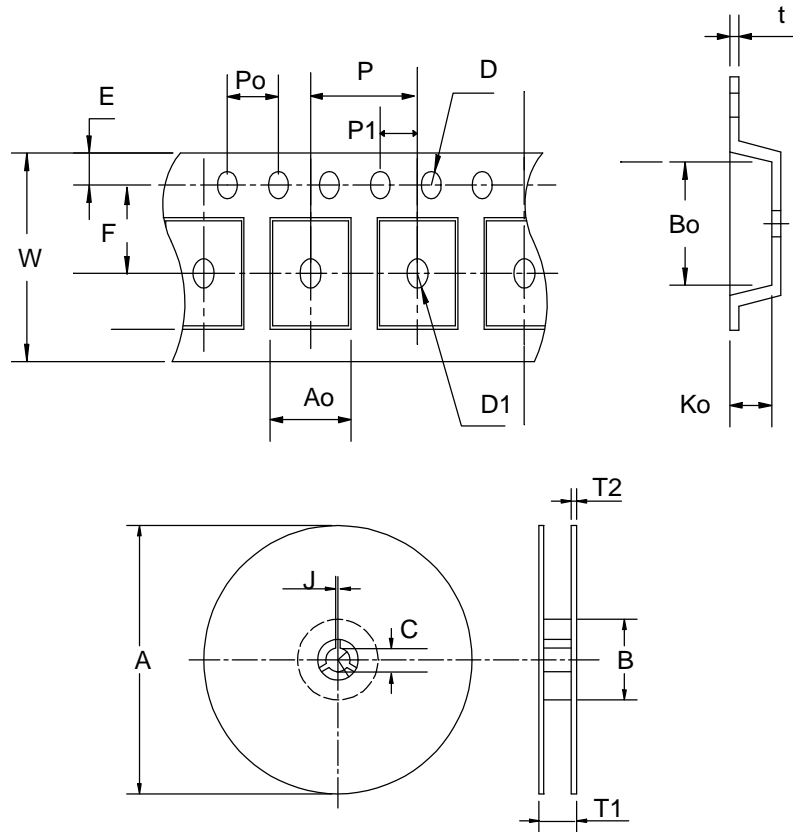

Application	A	B	C	J	T1	T2	W	P	E
SOP-8	330±1	62 ± 1.5	12.75 + 0.15	2 + 0.5	12.4 +0.2	2± 0.2	12 + 0.3 - 0.1	8± 0.1	1.75± 0.1
	F	D	D1	Po	P1	Ao	Bo	Ko	t
	5.5 ± 0.1	1.55±0.1	1.55+ 0.25	4.0 ± 0.1	2.0 ± 0.1	6.4 ± 0.1	5.2± 0.1	2.1± 0.1	0.3±0.013

(mm)

Cover Tape Dimensions

Application	Carrier Width	Cover Tape Width	Devices Per Reel
SOP- 8	12	9.3	2500