

BMI055

Small, versatile 6DoF sensor module

Bosch Sensortec



BOSCH

Invented for life

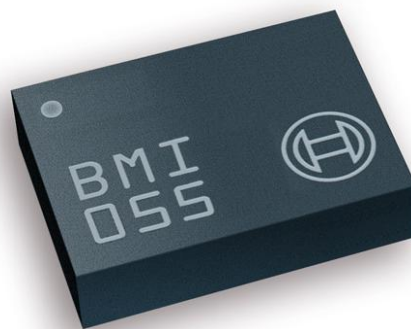

BMI055: Data sheet

Document revision	1.2
Document release date	July 24 th , 2014
Document number	BST-BMI055-DS000-08
Technical reference code(s)	0 273 141 134

Notes

Data and descriptions within this document are subject to change without notice.

Product photos and pictures are for illustration purposes only and may differ from the real product's appearance.

BMI055

Basic Description

Key features

- 2 inertial sensors in one device an advanced triaxial 16bit gyroscope and a versatile, leading edge triaxial 12bit accelerometer for reduced PCB space and simplified signal routing
- Small package LGA package 16 pins
footprint 3.0 x 4.5 mm², height 0.95mm
- Common voltage supplies V_{DD} voltage range: 2.4V to 3.6V
- Digital interface SPI (4-wire, 3-wire), I²C, 4 interrupt pins
 V_{DDIO} voltage range: 1.2V to 3.6V
- Smart operation and integration Gyroscope and accelerometer can be operated individually
- Consumer electronics suite MSL1, RoHS compliant, halogen-free
Operating temperature: -40°C ... +85°C
9DoF software compatible

Accelerometer features

- Programmable functionality Acceleration ranges $\pm 2g/\pm 4g/\pm 8g/\pm 16g$
Low-pass filter bandwidths 1kHz - <8Hz
- On-chip FIFO Integrated FIFO with a depth of 32 frames
- On-chip interrupt controller Motion-triggered interrupt-signal generation for
 - new data
 - any-motion (slope) detection
 - tap sensing (single tap / double tap)
 - orientation- & motion inactivity recognition
 - flat/low-g/high-g detection
- On-chip temperature sensor factory trimmed, 8-bit, typical slope 0.5K/LSB.
- Ultra-low power IC 130 μ A current consumption, 1.3ms wake-up time, advanced features for system power management

Gyroscope features

- Programmable functionality Ranges switchable from $\pm 125^\circ/s$ to $\pm 2000^\circ/s$
Low-pass filter bandwidths 230Hz - 12Hz
Fast and slow offset controller (FOC and SOC)
- On-chip FIFO Integrated FIFO with a depth of 100 frames
- On-chip interrupt controller Motion-triggered interrupt-signal generation for
 - new data
 - any-motion (slope) detection
 - high rate
- Low power IC < 5mA current consumption, 30ms start-up time
wake-up time in fast power-up mode only 10ms

Typical applications

- Advanced gaming & HMI
- Advanced gesture recognition
- Indoor navigation
- Image stabilization
- Display profile switching
- Advanced system power management for mobile applications
- Menu scrolling, tap / double tap sensing
- Pedometer / step counting
- Free-fall detection
- E-compass tilt compensation
- Drop detection for warranty logging

General description

The BMI055 is an inertial measurement unit (IMU) for the detection of movements and rotations in 6 degrees of freedom (6DoF). It reflects the full functionality of a triaxial, low-g acceleration sensor and at the same time it is capable to measure angular rates. Both – acceleration and angular rate – in three perpendicular room dimensions, the x-, y- and z-axis.

The BMI055 is designed to meet all requirements for consumer applications such as gaming and pointing devices, HMI and image stabilization (DSC and camera-phone). It also senses tilt, motion, inactivity and shock vibration in cell phones, handhelds, computer peripherals, man-machine interfaces, virtual reality features and game controllers.

An evaluation circuitry (ASIC) converts the output of the micro-electromechanical sensing structures (MEMS), developed, produced and tested in BOSCH facilities. The corresponding chip-sets are packed into one single LGA 3.0mm x 4.5mm x 0.95mm housing. For optimum system integration the BMI055 is fitted with digital bi-directional SPI and I²C interfaces. To provide maximum performance and reliability each device is tested and ready-to-use calibrated.

Package and interfaces of the BMI055 have been defined to match a multitude of hardware requirements. Since the sensor features a small footprint, a flat package and very low power consumption it is ingeniously suited for mobile-phone and tablet PC applications.

The BMI055 offers a variable V_{DDIO} voltage range from 1.2V to 3.6V and can be programmed to optimize functionality, performance and power consumption in customer specific applications. In addition it features on-chip interrupt controllers enabling motion-based applications without use of a microcontroller.

Index of Contents

BASIC DESCRIPTION	2
1. SPECIFICATION	11
1.1 ELECTRICAL SPECIFICATION.....	11
1.2 ELECTRICAL AND PHYSICAL CHARACTERISTICS, MEASUREMENT PERFORMANCE	12
2. ABSOLUTE MAXIMUM RATINGS	17
3. BLOCK DIAGRAM	18
4. BASIC POWER MANAGEMENT	19
5. FUNCTIONAL DESCRIPTION ACCELEROMETER	20
5.1 POWER MODES ACCELEROMETER	20
5.2 IMU DATA ACCELEROMETER	24
5.2.1 ACCELERATION DATA	24
5.2.2 TEMPERATURE SENSOR.....	25
5.3 SELF-TEST ACCELEROMETER.....	25
5.4 OFFSET COMPENSATION ACCELEROMETER.....	26
5.4.1 SLOW COMPENSATION	28
5.4.2 FAST COMPENSATION.....	28
5.4.3 MANUAL COMPENSATION.....	29
5.4.4 INLINE CALIBRATION	29
5.5 NON-VOLATILE MEMORY ACCELEROMETER	30
5.6 INTERRUPT CONTROLLER ACCELEROMETER	30
5.6.1 GENERAL FEATURES	31
5.6.2 MAPPING TO PHYSICAL INTERRUPT PINS (INTTYPE TO INT PIN#)	32
5.6.3 ELECTRICAL BEHAVIOR (INT PIN# TO OPEN-DRIVE OR PUSH-PULL)	32
5.6.4 NEW DATA INTERRUPT.....	33
5.6.5 SLOPE / ANY-MOTION DETECTION	33
5.6.6 ORIENTATION RECOGNITION	37
5.6.7 FLAT DETECTION.....	41
5.6.8 LOW-G INTERRUPT	42
5.6.9 HIGH-G INTERRUPT	42
5.6.10 NO-MOTION / SLOW MOTION DETECTION.....	43
5.7 SOFTRESET ACCELEROMETER	44
6. REGISTER DESCRIPTION ACCELEROMETER	45
6.1 GENERAL REMARKS ACCELEROMETER	45
6.2 REGISTER MAP ACCELEROMETER	46
ACC REGISTER 0x00 (BGW_CHIPID)	47

ACC REGISTER 0x01 IS RESERVED.....	47
ACC REGISTER 0x02 (ACCD_X_LSB).....	47
ACC REGISTER 0x03 (ACCD_X_MSB).....	48
ACC REGISTER 0x04 (ACCD_Y_LSB).....	48
ACC REGISTER 0x05 (ACCD_Y_MSB).....	49
ACC REGISTER 0x06 (ACCD_Z_LSB).....	49
ACC REGISTER 0x07 (ACCD_Z_MSB).....	50
ACC REGISTER 0x08 (ACCD_TEMP).....	50
ACC REGISTER 0x09 (INT_STATUS_0).....	51
ACC REGISTER 0x0A (INT_STATUS_1).....	52
ACC REGISTER 0x0B (INT_STATUS_2).....	52
ACC REGISTER 0x0C (INT_STATUS_3).....	53
ACC REGISTER 0x0D IS RESERVED.....	54
ACC REGISTER 0x0E (FIFO_STATUS).....	54
ACC REGISTER 0x0F (PMU_RANGE).....	54
ACC REGISTER 0x10 (PMU_BW).....	55
ACC REGISTER 0x11 (PMU_LPW).....	55
ACC REGISTER 0x12 (PMU_LOW_POWER).....	56
ACC REGISTER 0x13 (ACCD_HBW).....	57
ACC REGISTER 0x14 (BGW_SOFTRESET).....	57
ACC REGISTER 0x15 IS RESERVED.....	58
ACC REGISTER 0x16 (INT_EN_0).....	58
ACC REGISTER 0x17 (INT_EN_1).....	58
ACC REGISTER 0x18 (INT_EN_2).....	59
ACC REGISTER 0x19 (INT_MAP_0).....	59
ACC REGISTER 0x1A (INT_MAP_1).....	60
ACC REGISTER 0x1B (INT_MAP_2).....	61
ACC REGISTER 0x1C IS RESERVED.....	61
ACC REGISTER 0x1D IS RESERVED.....	61
ACC REGISTER 0x1E (INT_SRC).....	61
ACC REGISTER 0x1F IS RESERVED.....	62
ACC REGISTER 0x20 (INT_OUT_CTRL).....	62
ACC REGISTER 0x21 (INT_RST_LATCH).....	62
ACC REGISTER 0x22 (INT_0).....	63
ACC REGISTER 0x23 (INT_1).....	63

ACC REGISTER 0x24 (INT_2)	64
ACC REGISTER 0x25 (INT_3)	64
ACC REGISTER 0x26 (INT_4)	65
ACC REGISTER 0x27 (INT_5)	65
ACC REGISTER 0x28 (INT_6)	66
ACC REGISTER 0x29 (INT_7)	67
ACC REGISTER 0x2A (INT_8)	67
ACC REGISTER 0x2B (INT_9)	68
ACC REGISTER 0x2C (INT_A)	68
ACC REGISTER 0x2D (INT_B)	69
ACC REGISTER 0x2E (INT_C)	69
ACC REGISTER 0x2F (INT_D)	70
ACC REGISTER 0x30 (FIFO_CONFIG_0)	70
ACC REGISTER 0x31 IS RESERVED	71
ACC REGISTER 0x32 (PMU_SELF_TEST)	71
ACC REGISTER 0x33 (TRIM_NVM_CTRL)	72
ACC REGISTER 0x34 (BGW_SPI3_WDT)	72
ACC REGISTER 0x35 IS RESERVED	73
ACC REGISTER 0x36 (OFC_CTRL)	73
ACC REGISTER 0x37 (OFC_SETTING)	74
ACC REGISTER 0x38 (OFC_OFFSET_X)	74
ACC REGISTER 0x39 (OFC_OFFSET_Y)	75
ACC REGISTER 0x3A (OFC_OFFSET_Z)	76
ACC REGISTER 0x3B (TRIM_GP0)	76
ACC REGISTER 0x3C (TRIM_GP1)	77
ACC REGISTER 0x3D IS RESERVED	77
ACC REGISTER 0x3E (FIFO_CONFIG_1)	77
ACC REGISTER 0x3F (FIFO_DATA)	78
7. FUNCTIONAL DESCRIPTION GYRO	79
7.1 POWER MODES GYROSCOPE	79
7.1.1 ADVANCED POWER-SAVING MODES	80
7.2 IMU DATA GYRO	82
7.2.1 RATE DATA	82
7.3 ANGULAR RATE READ-OUT	83

7.4 SELF-TEST GYRO.....	83
7.5 OFFSET COMPENSATION GYROSCOPE	84
7.5.1 SLOW COMPENSATION	84
7.5.2 FAST COMPENSATION.....	84
7.5.3 MANUAL COMPENSATION.....	85
7.5.4 INLINE CALIBRATION	85
7.6 NON-VOLATILE MEMORY GYROSCOPE.....	85
7.7 INTERRUPT CONTROLLER GYRO	86
7.7.1 GENERAL FEATURES	86
7.7.2 MAPPING TO PHYSICAL INTERRUPT PINS (INTTYPE TO INT PIN#).....	88
7.7.3 ELECTRICAL BEHAVIOR (INT PIN# TO OPEN-DRIVE OR PUSH-PULL)	88
7.7.4 NEW DATA INTERRUPT.....	88
7.7.5 ANY-MOTION DETECTION / INTERRUPT	88
7.7.6 HIGH-RATE INTERRUPT	90
8. REGISTER DESCRIPTION GYROSCOPE	92
8.1 GENERAL REMARKS	92
8.2 REGISTER MAP GYROSCOPE	93
GYR REGISTER 0x00 (CHIP_ID)	94
GYR REGISTER 0x01 IS RESERVED.....	94
GYR REGISTER 0x02 (RATE_X_LSB)	94
GYR REGISTER 0x03 (RATE_X_MSB)	95
GYR REGISTER 0x04 (RATE_Y_LSB)	95
GYR REGISTER 0x05 (RATE_Y_MSB)	96
GYR REGISTER 0x06 (RATE_Z_LSB).....	96
GYR REGISTER 0x07 (RATE_Z_MSB).....	97
GYR REGISTER 0x08 RESERVED	97
GYR REGISTER 0x09 (INT_STATUS_0)	97
GYR REGISTER 0x0A (INT_STATUS_1)	98
GYR REGISTER 0x0B (INT_STATUS_2)	98
GYR REGISTER 0x0C (INT_STATUS_3).....	99
GYR REGISTER 0x0D IS RESERVED	99
GYR REGISTER 0x0E (FIFO_STATUS).....	99
GYR REGISTER 0x0F (RANGE)	100
GYR REGISTER 0x10 (BW)	100
GYR REGISTER 0x11 (LPM1).....	101
GYR REGISTER 0x12 (LPM2).....	102
GYR REGISTER 0x13 (RATE_HBW)	103
GYR REGISTER 0x14 (BGW_SOFTRESET)	104

GYR REGISTER 0x15 (INT_EN_0)	104
GYR REGISTER 0x16 (INT_EN_1)	105
GYR REGISTER 0x17 (INT_MAP_0).....	105
GYR REGISTER 0x18 (INT_MAP_1).....	106
GYR REGISTER 0x19 (INT_MAP_2).....	106
GYR REGISTER 0x1A.....	107
GYR REGISTER 0x1B.....	107
GYR REGISTER 0x1C	108
GYR REGISTER 0x1D IS RESERVED.	108
GYR REGISTER 0x1E.....	108
GYR REGISTER 0x1F AND 0x20 ARE RESERVED.....	109
GYR REGISTER 0x21 (INT_RST_LATCH).....	109
GYR REGISTER 0x22 (HIGH_TH_X)	109
GYR REGISTER 0x23 (HIGH_DUR_X).....	110
GYR REGISTER 0x24 (HIGH_TH_Y)	110
GYR REGISTER 0x25 (HIGH_DUR_Y).....	111
GYR REGISTER 0x26 (HIGH_TH_Z)	111
GYR REGISTER 0x27 (HIGH_DUR_Z).....	112
GYR REGISTER 0x28 TO 0x30 ARE RESERVED	112
GYR REGISTER 0x31 (SOC)	112
GYR REGISTER 0x32 (A_FOC)	113
GYR REGISTER 0x33 (TRIM_NVM_CTRL)	114
GYR REGISTER 0x34 (BGW_SPI3_WDT).....	114
GYR REGISTER 0x35 IS RESERVED.....	115
GYR REGISTER 0x36 (OFC1)	115
GYR REGISTER 0x37 (OFC2)	115
GYR REGISTER 0x38 (OFC3)	116
GYR REGISTER 0x39 (OFC4)	117
GYR REGISTER 0x3A (TRIM_GP0).....	117
GYR REGISTER 0x3B (TRIM_GP1).....	118
GYR REGISTER 0x3C (BIST)	118
GYR REGISTER 0x3D (FIFO_CONFIG_0).....	119
GYR REGISTER 0x3E (FIFO_CONFIG_1).....	119
9. DIGITAL INTERFACE OF THE DEVICE.....	121

9.1 SERIAL PERIPHERAL INTERFACE (SPI).....	122
9.2 INTER-INTEGRATED CIRCUIT (I ² C).....	126
9.2.1 SPI AND I ² C ACCESS RESTRICTIONS	129
10. FIFO OPERATION	130
10.1 FIFO OPERATING MODES	130
10.2 FIFO DATA READOUT	131
10.2.1 DATA READOUT ACCELEROMETER.....	131
10.2.2 DATA READOUT GYROSCOPE	132
10.2.3 EXTERNAL FIFO SYNCHRONIZATION (EFS) FOR THE GYROSCOPE	132
10.2.4 INTERFACE SPEED REQUIREMENTS FOR GYROSCOPE FIFO USE.....	133
10.3 FIFO FRAME COUNTER AND OVERRUN FLAG	133
10.4 FIFO INTERRUPTS	134
11. PIN-OUT AND CONNECTION DIAGRAM	135
11.1 PIN-OUT	135
11.2 CONNECTION DIAGRAM 4 WIRE SPI.....	136
11.3 CONNECTION DIAGRAM 3-WIRE SPI	137
11.4 CONNECTION DIAGRAM I ² C.....	138
12. PACKAGE	139
12.1 OUTLINE DIMENSIONS	139
12.2 SENSING AXES ORIENTATION	140
12.3 LANDING PATTERN RECOMMENDATION	142
12.4 MARKING	143
12.4.1 MASS PRODUCTION SAMPLES	143
12.4.2 ENGINEERING SAMPLES	143
12.5 SOLDERING GUIDELINES.....	144
12.6 HANDLING INSTRUCTIONS.....	145
12.7 TAPE AND REEL SPECIFICATION.....	145
12.7.1 ORIENTATION WITHIN THE REEL	146
12.8 ENVIRONMENTAL SAFETY	146
12.8.1 HALOGEN CONTENT	146
12.8.2 INTERNAL PACKAGE STRUCTURE.....	146
13. LEGAL DISCLAIMER	147
13.1 ENGINEERING SAMPLES.....	147
13.2 PRODUCT USE	147
13.3 APPLICATION EXAMPLES AND HINTS	147



14. DOCUMENT HISTORY AND MODIFICATION148

1. Specification

If not stated otherwise, the given values are over lifetime and full performance temperature and voltage ranges, minimum/maximum values are $\pm 3\sigma$.

1.1 Electrical specification

Table 1: Electrical parameter specification

OPERATING CONDITIONS						
Parameter	Symbol	Condition	Min	Typ	Max	Unit
Supply Voltage Internal Domains	V_{DD}		2.4	3.0	3.6	V
Supply Voltage I/O Domain	V_{DDIO}		1.2	2.4	3.6	V
Voltage Input Low Level	$V_{IL,a}$	SPI & I ² C			$0.3V_{DDIO}$	-
Voltage Input High Level	$V_{IH,a}$	SPI & I ² C	$0.7V_{DDIO}$			-
Voltage Output Low Level	$V_{OL,a}$	$I_{OL} = 3\text{mA}$, SPI & I ² C			$0.23V_{DDIO}$	-
Voltage Output High Level	V_{OH}	$I_{OH} = 3\text{mA}$, SPI	$0.8V_{DDIO}$			-
Operating Temperature	T_A		-40		+85	°C

1.2 Electrical and physical characteristics, measurement performance

Table 2: Electrical characteristics accelerometer

OPERATING CONDITIONS ACCELEROMETER						
Parameter	Symbol	Condition	Min	Typ	Max	Units
Acceleration Range	g_{FS2g}	Selectable via serial digital interface		±2		g
	g_{FS4g}			±4		g
	g_{FS8g}			±8		g
	g_{FS16g}			±16		g
Total Supply Current in Normal Mode	I_{DD}	see ¹		130		μA
Total Supply Current in Suspend Mode	I_{DDsum}	see ¹		2.1		μA
Total Supply Current in Deep Suspend Mode	I_{DDdsum}	see ¹		1.0		μA
Total Supply Current in Low-power Mode 1	I_{DDlp1}	see ¹ sleep duration ≥ 25ms		6.5		μA
Total Supply Current in Low-power Mode 2	I_{DDlp2}	see ¹ sleep duration ≥ 25ms		66		μA
Total Supply Current in Standby Mode	I_{DDsbm}	see ¹		62		μA
Wake-Up Time 1	$t_{w,up1}$	from Low-power Mode 1 or Suspend Mode or Deep Suspend Mode bw = 1kHz		1.3		ms
Wake-Up Time 2	$t_{w,up2}$	from Low-power Mode 2 or Stand-by Mode bw = 1kHz		1		ms
Start-Up Time	$t_{s,up}$	POR, bw = 1kHz			3	ms
Non-volatile memory (NVM) write-cycles	n_{NVM}				15	Cycles

¹ Conditions of current consumption if not specified otherwise: $T_A=25^{\circ}C$, $BW_Accel=1kHz$, $V_{DD} = V_{DDIO} = 2.4V$, digital protocol on, no streaming data

OUTPUT SIGNAL ACCELEROMETER						
Parameter	Symbol	Condition	Min	Typ	Max	Units
Sensitivity	S_{2g}	$g_{FS2g}, T_A=25^\circ C$		1024		LSB/g
	S_{4g}	$g_{FS4g}, T_A=25^\circ C$		512		LSB/g
	S_{8g}	$g_{FS8g}, T_A=25^\circ C$		256		LSB/g
	S_{16g}	$g_{FS16g}, T_A=25^\circ C$		128		LSB/g
Sensitivity Temperature Drift	TCS	g_{FS2g} , Nominal V_{DD} supplies		± 0.02		%/K
Sensitivity Supply Volt. Drift	S_{VDD}	$g_{FS2g}, T_A=25^\circ C$, $V_{DD \min} \leq V_{DD} \leq V_{DD \max}$		0.05		%/V
Zero-g Offset (x,z)	Off _{x,z}	$g_{FS2g}, T_A=25^\circ C$, nominal V_{DD} supplies, over life-time		± 70		mg
Zero-g Offset (y)	Off _y	$g_{FS2g}, T_A=25^\circ C$, nominal V_{DD} supplies, over life-time		± 70		mg
Zero-g Offset Temperature Drift	TCO	g_{FS2g} , Nominal V_{DD} supplies		± 1		mg/K
Zero-g Offset Supply Volt. Drift	Off _{VDD}	$g_{FS2g}, T_A=25^\circ C$, $V_{DD \min} \leq V_{DD} \leq V_{DD \max}$		0.5		mg/V
Bandwidth	bw_8	2 nd order filter, bandwidth programmable		8		Hz
	bw_{16}			16		Hz
	bw_{31}			31		Hz
	bw_{63}			63		Hz
	bw_{125}			125		Hz
	bw_{250}			250		Hz
	bw_{500}			500		Hz
	bw_{1000}			1,000		Hz
Nonlinearity	NL	best fit straight line, g_{FS2g}		± 0.5		%FS
Output Noise Density	n_{rms}	$g_{FS2g}, T_A=25^\circ C$ Nominal V_{DD} supplies Normal mode		150		$\mu g/\sqrt{Hz}$
Temperature Sensor Measurement Range	T_S		-40		85	$^\circ C$
Temperature Sensor Slope	dT_S			0.5		K/LSB
Temperature Sensor Offset	OT _S			± 2		K

MECHANICAL CHARACTERISTICS ACCELEROMETER						
Parameter	Symbol	Condition	Min	Typ	Max	Units
Cross Axis Sensitivity	S	relative contribution between any two of the three axes		1		%
Alignment Error	E _A	relative to package outline		±0.5		°

Table 3: Electrical characteristics gyroscope

OPERATING CONDITIONS GYROSCOPE						
Parameter	Symbol	Condition	Min	Typ	Max	Unit
Range	R _{FS125}	Selectable via serial digital interface		125		°/s
	R _{FS250}			250		°/s
	R _{FS500}			500		°/s
	R _{FS1000}			1,000		°/s
	R _{FS2000}			2,000		°/s
Supply Current in Normal Mode	I _{DD}	see ²		5		mA
Supply Current in Fast Power-up Mode	I _{DDfpm}	see ²		2.5		mA
Supply Current in Suspend Mode	I _{DDsum}	see ² , digital and analog (only IF active)		25		μA
Supply Current in Deep Suspend Mode	I _{DDdsum}	see ²		<5		μA
Start-up time	t _{su}	to ±1%/s of final value; from power-off		30		ms
Wake-up time	t _{wusm}	From suspend- and deep suspend-modes		30		ms
Wake-up time	t _{wufpm}	From fast power-up mode		10		ms
Non-volatile memory (NVM) write-cycles	n _{NVM}				15	cycles

² Conditions of current consumption if not specified otherwise: T_A=25°C, BW_{Gyro}=1kHz, V_{DD}=2.4V, V_{DDIO}=1.8V, digital protocol on, no streaming data

OUTPUT SIGNAL GYROSCOPE						
Parameter	Symbol	Condition	Min	Typ	Max	Unit
Sensitivity		Ta=25°C, R _{FS2000}		16.4		LSB/°/s
		Ta=25°C, R _{FS1000}		32.8		LSB/°/s
		Ta=25°C, R _{FS500}		65.6		LSB/°/s
		Ta=25°C, R _{FS250}		131.2		LSB/°/s
		Ta=25°C, R _{FS125}		262.4		LSB/°/s
Sensitivity tolerance		Ta=25°C, R _{FS2000}		±1		%
Sensitivity Change over Temperature	TCS	Nominal V _{DD} supplies -40°C ≤ T _A ≤ +85°C R _{FS2000}		±0.03		%/K
Sensitivity Supply Volt. Drift	S _{VDD}	T _A =25°C, V _{DD_min} ≤ V _{DD} ≤ V _{DD_max}		<0.4		%/V
Nonlinearity	NL	best fit straight line R _{FS1000} , R _{FS2000}		±0.05		%FS
g- Sensitivity		Sensitivity to acceleration stimuli in all three axis (frequency <20kHz)			0.1	°/s/g
Zero-rate Offset	Off Ω _x Ω _y and Ω _z	Nominal V _{DD} supplies T _A =25°C, slow and fast offset cancellation off		±1		°/s
Zero-Ω Offset Change over Temperature	TCO	Nominal V _{DD} supplies -40°C ≤ T _A ≤ +85°C R _{FS2000}		±0.015		°/s per K
Zero-Ω Offset Supply Volt. Drift	OffΩ _{VDD}	T _A =25°C, V _{DD_min} ≤ V _{DD} ≤ V _{DD_max}		<0.1		°/s /V
Output Noise	n _{rms}	rms, BW=47Hz (@ 0.014°/s/√Hz)		0.1		°/s



Bandwidth BW	f_{-3dB}			unfiltered 230 116 64 47 32 23 12		Hz
Data rate (set of x,y,z rate)				2000 1000 400 200 100		Hz
Data rate tolerance (set of x,y,z rate)				±0.3		%
Cross Axis Sensitivity		Sensitivity to stimuli in non-sense-direction		±1		%

2. Absolute maximum ratings

Table 4: Absolute maximum ratings

Parameter	Condition	Min	Max	Units
Voltage at Supply Pin	V_{DD} Pin	-0.3	4.25	V
	V_{DDIO} Pin	-0.3	4.25	V
Voltage at any Logic Pin	Non-Supply Pin	-0.3	$V_{DDIO}+0.3$	V
Passive Storage Temp. Range	$\leq 65\%$ rel. H.	-50	+150	$^{\circ}\text{C}$
None-volatile memory (NVM) Data Retention	$T = 85^{\circ}\text{C}$, after 15 cycles	10		y
Mechanical Shock	Duration $\leq 200\mu\text{s}$		10,000	g
	Duration $\leq 1.0\text{ms}$		2,000	g
	Free fall onto hard surfaces		1.8	m
ESD	HBM, at any Pin		2	kV
	CDM		500	V
	MM		200	V

Note: Stress above these limits may cause damage to the device. Exceeding the specified electrical limits may affect the device reliability or cause malfunction.

3. Block diagram

Figure 1 shows the basic building blocks of the BMI055:

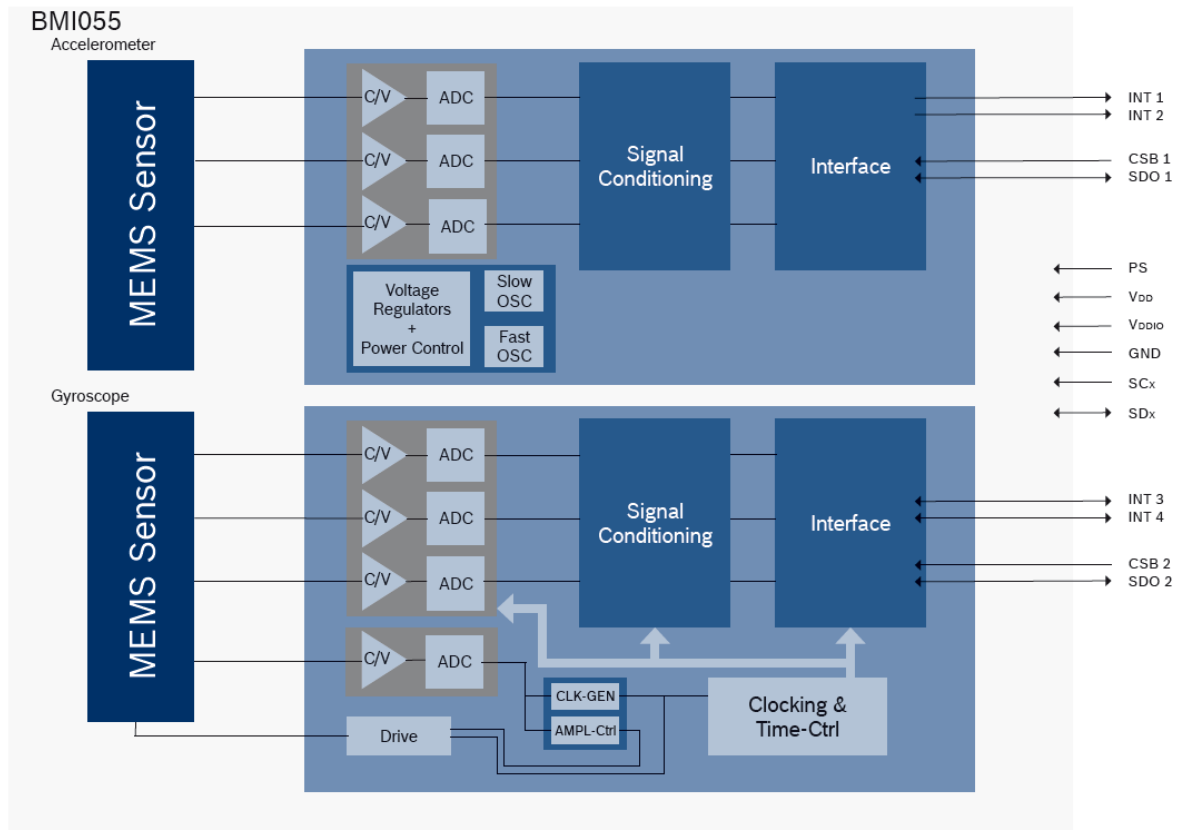

Figure 1: Block diagram of the BMI055

4. Basic power management

The BMI055 has two distinct power supply pins:

- V_{DD} is the main power supply for the internal blocks
- V_{DDIO} is a separate power supply pin mainly used for the supply of the interface

There are no limitations on the voltage levels of both pins relative to each other, as long as each of them lies within its operating range. Furthermore, the device can be completely switched off ($V_{DD} = 0V$) while keeping the V_{DDIO} supply on ($V_{DDIO} > 0V$) or vice versa.

When the V_{DDIO} supply is switched off, all interface pins (CSB, SDI, SCK, PS) must be kept close to GND_{IO} potential.

The device contains a power-on reset (POR) generator. It resets the logic part and the register values after powering-on V_{DD} and V_{DDIO} . Please note, that all application specific settings which are not equal to the default settings (refer to 6.2 register map accelerometer and to 8.2 register map gyroscope), must be re-set to its designated values after POR.

In case the I²C interface shall be used, a direct electrical connection between V_{DDIO} supply and the PS pin is needed in order to ensure reliable protocol selection. For SPI interface mode the PS pin must be directly connected to GND_{IO} .

5. Functional description accelerometer

Note: Default values for registers can be found in chapter 6.

5.1 Power modes accelerometer

The accelerometer has six different power modes. Besides normal mode, which represents the fully operational state of the device, there are five energy saving modes: deep-suspend mode, suspend mode, standby mode, low-power mode 1 and low-power mode 2.

The possible transitions between the power modes are illustrated in figure 2:

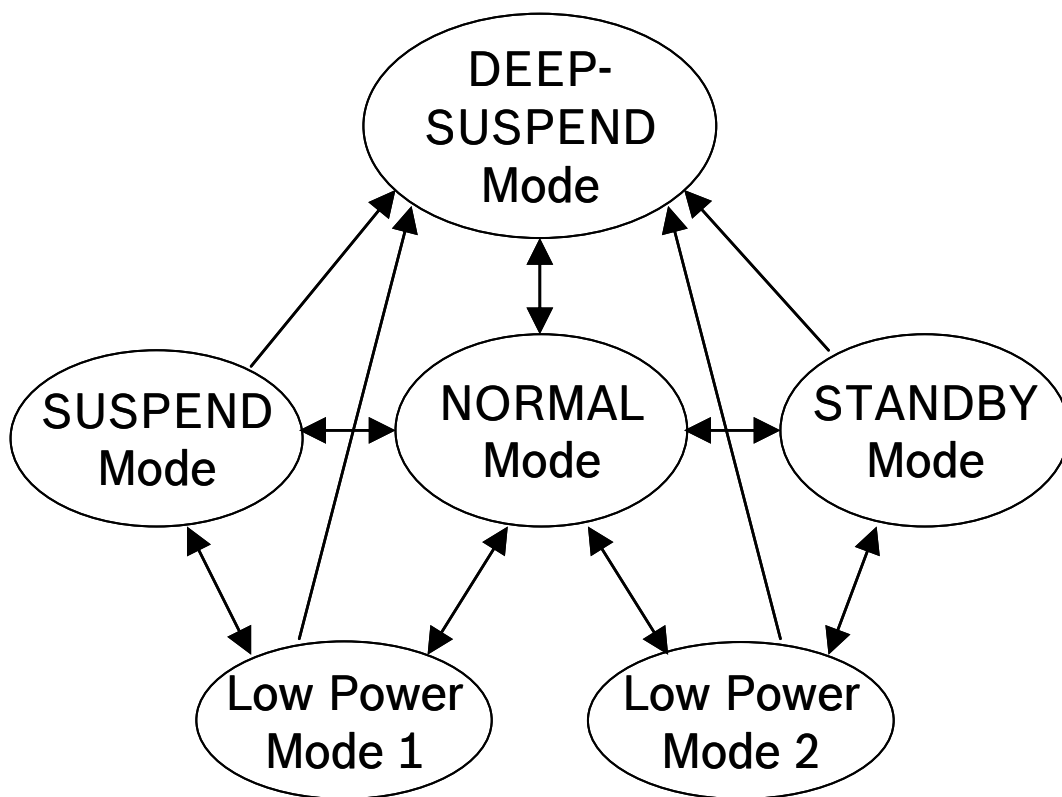

Figure 2: Power mode transition diagram

After power-up accelerometer is in normal mode so that all parts of the device are held powered-up and data acquisition is performed continuously.

In **deep-suspend** mode the device reaches the lowest possible power consumption. Only the interface section is kept alive. No data acquisition is performed and the content of the configuration registers is lost. Deep suspend mode is entered (left) by writing '1' ('0') to the (ACC 0x11) *deep_suspend* bit while (ACC 0x11) *suspend* bit is set to '0'. The I²C watchdog timer remains functional. The (ACC 0x11) *deep_suspend* bit, the (ACC 0x34) *spi3* bit, (ACC 0x34) *i2c_wdt_en* bit and the (ACC 0x34) *i2c_wdt_sel* bit are functional in deep-suspend mode. Equally the interrupt level and driver configuration registers (ACC 0x20) *int1_lvl*, (ACC 0x20)

int1_od, (ACC 0x20) *int2_lvl*, and (ACC 0x20) *int2_od* are accessible. Still it is possible to enter normal mode by performing a softreset as described in chapter 5.7. Please note, that all application specific settings which are not equal to the default settings (refer to 6.2 register map accelerometer), must be re-set to its designated values after leaving deep-suspend mode.

In **suspend mode** the whole analog part is powered down. No data acquisition is performed. While in suspend mode the latest acceleration data and the content of all configuration registers are kept. Writing to and reading from registers is supported except from the (0x3E) *fifo_config_1*, (0x30) *fifo_config_0* and (0x3F) *fifo_data* register. It is possible to enter normal mode by performing a softreset as described in chapter 5.7.

Suspend mode is entered (left) by writing '1' ('0') to the (ACC 0x11) *suspend* bit after bit (ACC 0x12) *lowpower_mode* has been set to '0'. Although write access to registers is supported at the full interface clock speed (SCL or SCK), a waiting period must be inserted between two consecutive write cycles (please refer also to section 9.2.1).

In **standby mode** the analog part is powered down, while the digital part remains largely operational. No data acquisition is performed. Reading and writing registers is supported without any restrictions. The latest acceleration data and the content of all configuration registers are kept. Standby mode is entered (left) by writing '1' ('0') to the (ACC 0x11) *suspend* bit after bit (ACC 0x12) *lowpower_mode* has been set to '1'. It is also possible to enter normal mode by performing a softreset as described in chapter 5.7.

In **low-power mode 1**, the device is periodically switching between a sleep phase and a wake-up phase. The wake-up phase essentially corresponds to operation in normal mode with complete power-up of the circuitry. The sleep phase essentially corresponds to operation in suspend mode. Low-power mode is entered (left) by writing '1' ('0') to the (ACC 0x11) *lowpower_en* bit with bit (ACC 0x12) *lowpower_mode* set to '0'. Read access to registers is possible except from the (0x3F) *fifo_data* register. However, unless the register access is synchronised with the wake-up phase, the restrictions of the suspend mode apply.

Low-power mode 2 is very similar to low-power mode 1, but register access is possible at any time without restrictions. It consumes more power than low-power mode 1. In low-power mode 2 the device is periodically switching between a sleep phase and a wake-up phase. The wake-up phase essentially corresponds to operation in normal mode with complete power-up of the circuitry. The sleep phase essentially corresponds to operation in standby mode. Low-power mode is entered (left) by writing '1' ('0') to the (ACC 0x11) *lowpower_en* bit with bit (ACC 0x12) *lowpower_mode* set to '1'.

The **timing behaviour** of the low-power modes 1 and 2 depends on the setting of the (ACC 0x12) *sleeptimer_en* bit. When (ACC 0x12) *sleeptimer_en* is set to '0', the event-driven time-base mode (EDT) is selected. In EDT the duration of the wake-up phase depends on the number of samples required by the enabled interrupt engines. If an interrupt is detected, the device stays in the wake-up phase as long as the interrupt condition endures (non-latched interrupt), or until the latch time expires (temporary interrupt), or until the interrupt is reset (latched interrupt). If no interrupt is detected, the device enters the sleep phase immediately after the required number of acceleration samples have been taken and an active interface access cycle has ended. The EDT mode is recommended for power-critical applications which do not use the FIFO. Also, EDT mode is compatible with legacy BST sensors. Figure 3 shows the timing diagram for low-power modes 1 and 2 when EDT is selected.

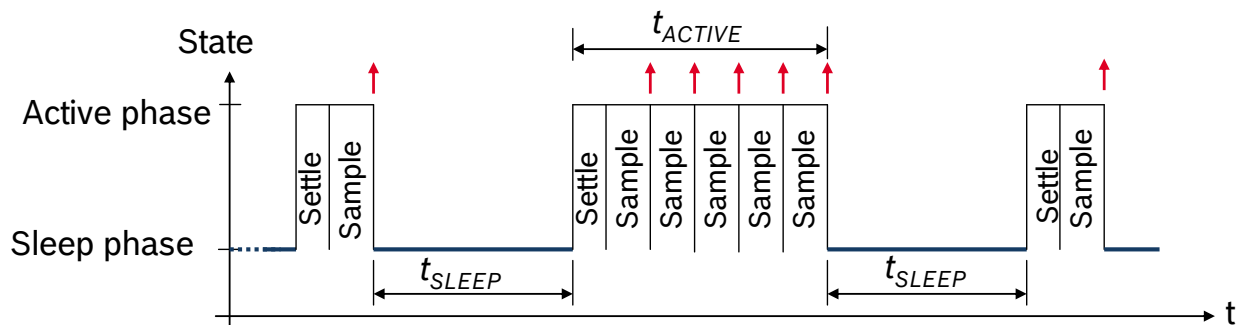

Figure 3: Timing Diagram for low-power mode 1/2, EDT

When (*ACC 0x12*) *sleeptimer_en* is set to '1', the equidistant-sampling mode (EST) is selected. The use of the EST mode is recommended when the FIFO is used since it ensures that equidistant samples are sampled into the FIFO regardless of whether the active phase is extended by active interrupt engines or interface activity. In EST mode the sleep time t_{SLEEP} is defined as shown in figure 4. The FIFO sampling time t_{SAMPLE} is the sum of the sleep time t_{SLEEP} and the sensor data sampling time t_{SSMP} . Since interrupt engines can extend the active phase to exceed the sleep time t_{SLEEP} , equidistant sampling is only guaranteed if the bandwidth has been chosen such that $1/(2 * bw) = n * t_{SLEEP}$ where n is an integer. If this condition is infringed, equidistant sampling is not possible. Once the sleep time has elapsed the device will store the next available sample in the FIFO. This set-up condition is not recommended as it may result in timing jitter.

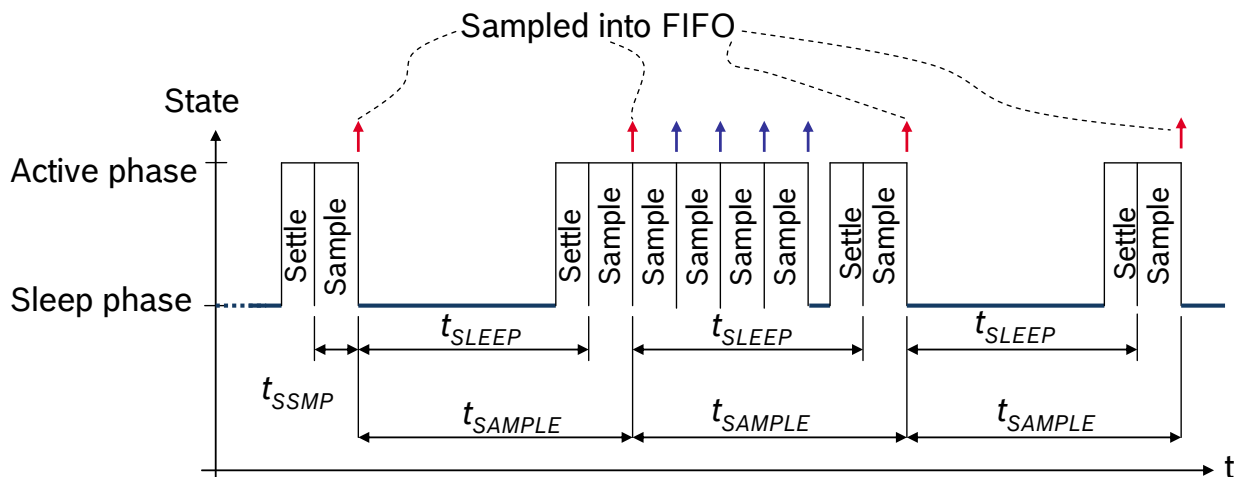

Figure 4: Timing Diagram for low-power mode 1/2, EST

The sleep time for lower-power mode 1 and 2 is set by the (*ACC 0x11*) *sleep_dur* bits as shown

in the following table:

Table 5: Sleep phase duration settings

(ACC 0x11) <i>sleep_dur</i>	Sleep Phase Duration t_{sleep}
0000b	0.5ms
0001b	0.5ms
0010b	0.5ms
0011b	0.5ms
0100b	0.5ms
0101b	0.5ms
0110b	1ms
0111b	2ms
1000b	4ms
1001b	6ms
1010b	10ms
1011b	25ms
1100b	50ms
1101b	100ms
1110b	500ms
1111b	1s

The current consumption of the accelerometer in low-power mode 1 (I_{DDlp1}) and low-power mode 2 (I_{DDlp2}) can be estimated according to the following formulae:

$$I_{DDlp1} \approx \frac{t_{sleep} \cdot I_{DDsum} + t_{active} \cdot I_{DD}}{t_{sleep} + t_{active}}$$

$$I_{DDlp2} \approx \frac{t_{sleep} \cdot I_{DDsbm} + t_{active} \cdot I_{DD}}{t_{sleep} + t_{active}}$$

When estimating the length of the wake-up phase t_{active} , the corresponding typical wake-up time, $t_{w,up1}$ or $t_{w,up2}$ and t_{ut} (given in table 6) have to be considered:

If bandwidth is ≥ 31.25 Hz:

$$t_{active} = t_{ut} + t_{w,up1} - 0.9 \text{ ms (or } t_{active} = t_{ut} + t_{w,up2} - 0.9 \text{ ms)}$$

else:

$$t_{active} = 4 t_{ut} + t_{w,up1} - 0.9 \text{ ms (or } t_{active} = 4 t_{ut} + t_{w,up2} - 0.9 \text{ ms)}$$

During the wake-up phase all analog modules are held powered-up, while during the sleep phase most analog modules are powered down. Consequently, a wake-up time of more than $t_{w,up1}$ ($t_{w,up2}$) ms is needed to settle the analog modules so that reliable acceleration data are generated.

5.2 IMU data accelerometer

5.2.1 Acceleration data

The width of acceleration data is 12 bits given in two's complement representation. The 12 bits for each axis are split into an MSB upper part (one byte containing bits 11 to 4) and an LSB lower part (one byte containing bits 3 to 0 of acceleration and a (*ACC 0x02, 0x04, 0x06*) *new_data* flag). Reading the acceleration data registers shall always start with the LSB part. In order to ensure the integrity of the acceleration data, the content of an MSB register is locked by reading the corresponding LSB register (shadowing procedure). When shadowing is enabled, the MSB must always be read in order to remove the data lock. The shadowing procedure can be disabled (enabled) by writing '1' ('0') to the bit *shadow_dis*. With shadowing disabled, the content of both MSB and LSB registers is updated by a new value immediately. Unused bits of the LSB registers may have any value and should be ignored. The (*ACC 0x02, 0x04, 0x06*) *new_data* flag of each LSB register is set if the data registers have been updated. The flag is reset if either the corresponding MSB or LSB part is read.

Two different streams of acceleration data are available, unfiltered and filtered. The unfiltered data is sampled with 2kHz. The sampling rate of the filtered data depends on the selected filter bandwidth and is always twice the selected bandwidth ($BW = ODR/2$). Which kind of data is stored in the acceleration data registers depends on bit (*ACC 0x13*) *data_high_bw*. If (*ACC 0x13*) *data_high_bw* is '0' ('1'), then filtered (unfiltered) data is stored in the registers. Both data streams are offset-compensated.

The bandwidth of filtered acceleration data is determined by setting the (*ACC 0x10*) *bw* bit as followed:

Table 6: Bandwidth configuration

bw	Bandwidth	Update Time t_{ut}
00xxx	*)	-
01000	7.81Hz	64ms
01001	15.63Hz	32ms
01010	31.25Hz	16ms
01011	62.5Hz	8ms
01100	125Hz	4ms
01101	250Hz	2ms
01110	500Hz	1ms
01111	1000Hz	0.5ms
1xxxx	*)	-

*) Note: Settings 00xxx result in a bandwidth of 7.81 Hz; settings 1xxxx result in a bandwidth of 1000 Hz. It is recommended to actively set an application specific and an appropriate bandwidth and to use the range from '01000b' to '01111b' only in order to be compatible with future products.

The accelerometer supports four different acceleration measurement ranges. A measurement range is selected by setting the (*ACC 0x0F*) range bits as follows:

Table 7: Range selection

Range	Acceleration measurement range	Resolution
0011	±2g	0.98mg/LSB
0101	±4g	1.95mg/LSB
1000	±8g	3.91mg/LSB
1100	±16g	7.81mg/LSB
others	reserved	-

5.2.2 Temperature Sensor

The width of temperature data is 8 bits given in two's complement representation. Temperature values are available in the (*ACC 0x08*) *temp* register.

The slope of the temperature sensor is 0.5K/LSB, its center temperature is 23°C [(*ACC 0x08*) *temp* = 0x00].

5.3 Self-test accelerometer

This feature permits to check the sensor functionality by applying electrostatic forces to the sensor core instead of external accelerations. By actually deflecting the seismic mass, the entire signal path of the sensor can be tested. Activating the self-test results in a static offset of the acceleration data; any external acceleration or gravitational force applied to the sensor during active self-test will be observed in the output as a superposition of both acceleration and self-test signal.

Before the self-test is enabled the g-range should be set to 8 g. The self-test is activated individually for each axis by writing the proper value to the (*ACC 0x32*) *self_test_axis* bits ('01b' for x-axis, '10b' for y-axis, '11b' for z-axis, '00b' to deactivate self-test). It is possible to control the direction of the deflection through bit (*ACC 0x32*) *self_test_sign*. The excitation occurs in negative (positive) direction if (*ACC 0x32*) *self_test_sign* = '0b' ('1b'). The amplitude of the deflection has to be set high by writing (*ACC 0x32*) *self_test_amp*='1b'. After the self-test is enabled, the user should wait 50ms before interpreting the acceleration data.

In order to ensure a proper interpretation of the self-test signal it is recommended to perform the self-test for both (positive and negative) directions and then to calculate the difference of the resulting acceleration values. Table 8 shows the minimum differences for each axis. The actually measured signal differences can be significantly larger.

Table 8: Self-test difference values

	x-axis signal	y-axis signal	z-axis signal
resulting minimum difference signal	800 mg	800 mg	400 mg

It is recommended to perform a reset of the device after a self-test has been performed. If the reset cannot be performed, the following sequence must be kept to prevent unwanted interrupt generation: disable interrupts, change parameters of interrupts, wait for at least 50ms, enable desired interrupts.

5.4 Offset compensation accelerometer

Offsets in measured signals can have several causes but they are always unwanted and disturbing in many cases. Therefore, the accelerometer offers an advanced set of four digital offset compensation methods which are closely matched to each other. These are slow, fast, and manual compensation as well as inline calibration.

The compensation is performed with filtered data, and is then applied to both, unfiltered and filtered data. If necessary the result of this computation is saturated to prevent any overflow errors (the smallest or biggest possible value is set, depending on the sign). However, the registers used to read and write compensation values have a width of 8 bits.

An overview of the offset compensation principle is given in figure 5:

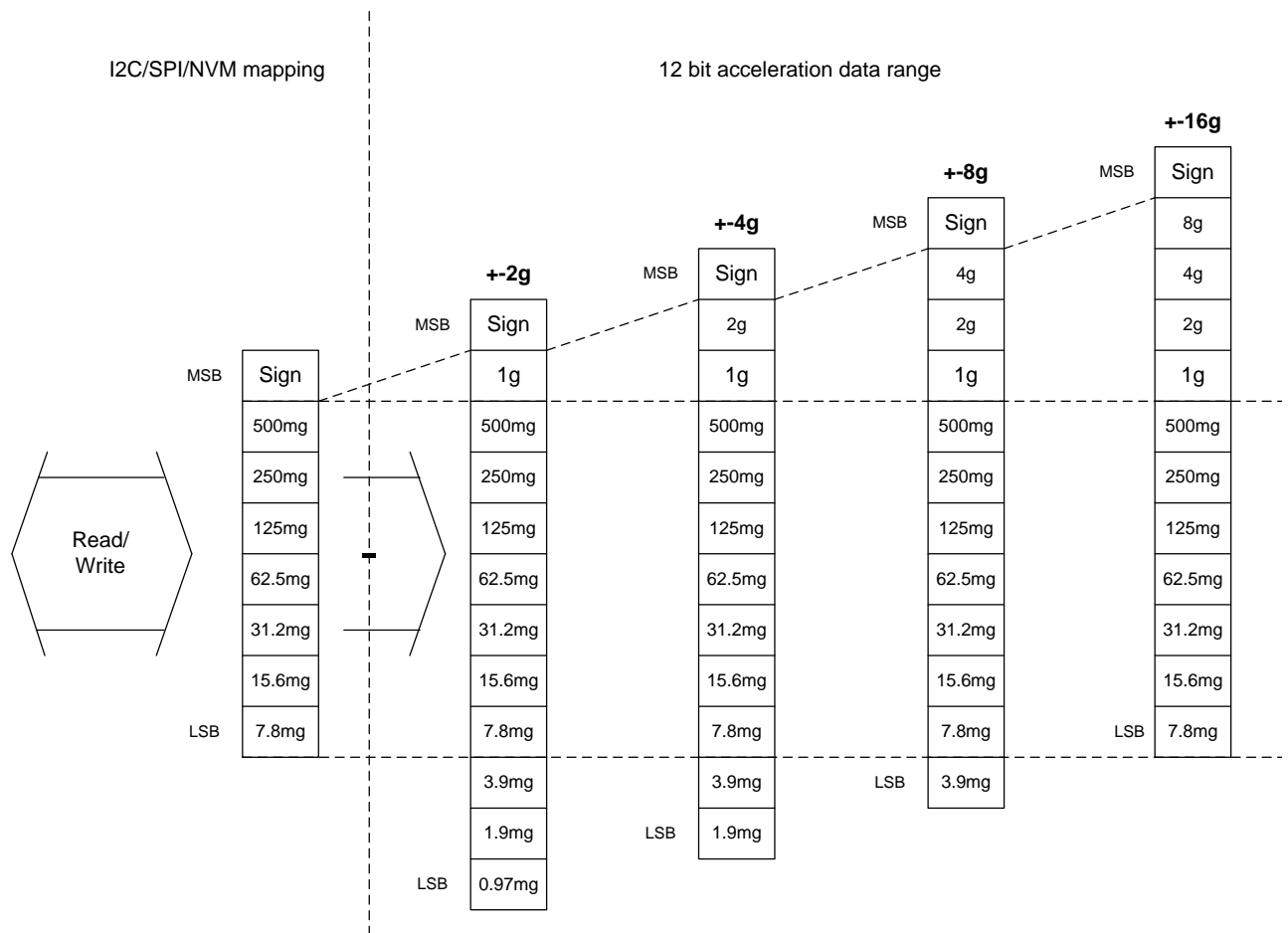

Figure 5: Principle of offset compensation

The public offset compensation registers (*ACC 0x38*) *offset_x*, (*ACC 0x39*) *offset_y*, (*ACC 0x3A*) *offset_z* are images of the corresponding registers in the NVM. With each image update (see section 5.5 Non-volatile memory accelerometer for details) the contents of the NVM registers are written to the public registers. The public registers can be over-written by the user at any time. After changing the contents of the public registers by either an image update or manually, all 8bit values are extended to 12bit values for internal computation. In the opposite direction, if an internally computed value changes it is converted to an 8bit value and stored in the public register.

Depending on the selected g-range the conversion from 12bit to 8bit values can result in a loss of accuracy of one to several LSB. This is shown in figure 5.

In case an internally computed compensation value is too small or too large to fit into the corresponding register, it is saturated in order to prevent an overflow error.

By writing '1' to the (*ACC 0x36*) *offset_reset* bit, all offset compensation registers are reset to zero.

5.4.1 Slow compensation

Slow compensation is based on a 1st order high-pass filter, which continuously drives the average value of the output data stream of each axis to zero. The bandwidth of the high-pass filter is configured with bit (*ACC 0x37*) *cut_off* according to table 9.

Table 9: Compensation period settings

(<i>ACC 0x37</i>) <i>cut_off</i>	high-pass filter bandwidth
0b	1
1b	10 Hz

The slow compensation can be enabled (disabled) for each axis independently by setting the bits (*ACC 0x36*) *hp_x_en*, *hp_y_en*, *hp_z_en* to '1' ('0'), respectively.

Slow compensation should not be used in combination with low-power mode. In low-power mode the conditions (availability of necessary data) for proper function of slow compensation are not fulfilled.

5.4.2 Fast compensation

Fast compensation is a one-shot process by which the compensation value is set in such a way that when added to the raw acceleration, the resulting acceleration value of each axis approaches the target value. This is best suited for "end-of-line trimming" with the customer's device positioned in a well-defined orientation. For fast compensation the g-range has to be switched to 2g.

The algorithm in detail: An average of 16 consecutive acceleration values is computed and the difference between target value and computed value is written to (*ACC 0x38*, *0x39*, *0x3A*) *offset_filt_x/y/z*. The public registers (*ACC 0x38*, *0x39*, *0x3A*) *offset_filt_x/y/z* are updated with the contents of the internal registers (using saturation if necessary) and can be read by the user.

Fast compensation is triggered for each axis individually by setting the (*ACC 0x36*) *cal_trigger* bits as shown in table 10:

Table 10: Fast compensation axis selection

(<i>ACC 0x36</i>) <i>cal_trigger</i>	Selected Axis
00b	none
01b	x
10b	y
11b	z

Register (*ACC 0x36*) *cal_trigger* is a write-only register. Once triggered, the status of the fast correction process is reflected in the status bit (*ACC 0x36*) *cal_rdy*. Bit (*ACC 0x36*) *cal_rdy* is '0'

while the correction is in progress. Otherwise it is '1'. Bit (ACC 0x36) *cal_rdy* is '0' when (ACC 0x36) *cal_trigger* is not '00'.

For the fast offset compensation, the compensation target can be chosen by setting the bits (ACC 0x37) *offset_target_x*, (ACC 0x37) *offset_target_y*, and (ACC 0x37) *offset_target_z* according to table 11:

Table 11: Offset target settings

(ACC 0x37) <i>offset_target_x/y/z</i>	Target value
00b	0g
01b	+1g
10b	-1g
11b	0g

Fast compensation should not be used in combination with any of the low-power modes. In low-power mode the conditions (availability of necessary data) for proper function of fast compensation are not fulfilled.

5.4.3 Manual compensation

The contents of the public compensation registers (ACC 0x38, 0x39, 0x3A) *offset_filt_x/y/z* can be set manually via the digital interface. It is recommended to write into these registers directly after a new data interrupt has occurred in order not to disturb running offset computations.

Writing to the offset compensation registers is not allowed while the fast compensation procedure is running.

5.4.4 Inline calibration

For certain applications, it is often desirable to calibrate the offset once and to store the compensation values permanently. This can be achieved by using one of the aforementioned offset compensation methods to determine the proper compensation values and then storing these values permanently in the NVM. See section 5.5 Non-volatile memory accelerometer for details of the storing procedure.

Each time the device is reset, the compensation values are loaded from the non-volatile memory into the image registers and used for offset compensation. until they are possibly overwritten using one of the other compensation methods.

5.5 Non-volatile memory accelerometer

The entire memory of the accelerometer consists of three different kinds of registers: hard-wired, volatile, and non-volatile. Part of it can be both read and written by the user. Access to non-volatile memory is only possible through (volatile) image registers.

Altogether, there are eight registers (octets) with NVM backup which are accessible by the user. The addresses of the image registers range from (ACC 0x38) to (ACC 0x3C). While the addresses up to (ACC 0x3A) are used for offset compensation (see 5.4 Offset Compensation), addresses (ACC 0x3B) and (ACC 0x3C) are general purpose registers not linked to any sensor-specific functionality.

The content of the NVM is loaded to the image registers after a reset (either POR or softreset) or after a user request which is performed by writing '1' to the write-only bit (ACC 0x33) *nvm_load*. As long as the image update is in progress, bit (ACC 0x33) *nvm_rdy* is '0', otherwise it is '1'.

The image registers can be read and written like any other register.

Writing to the NVM is a three-step procedure:

1. Write the new contents to the image registers.
2. Write '1' to bit (ACC 0x33) *nvm_prog_mode* in order to unlock the NVM.
3. Write '1' to bit (ACC 0x33) *nvm_prog_trig* and keep '1' in bit (ACC 0x33) *nvm_prog_mode* in order to trigger the write process.

Writing to the NVM always renews the entire NVM contents. It is possible to check the write status by reading bit (ACC 0x33) *nvm_rdy*. While (ACC 0x33) *nvm_rdy* = '0', the write process is still in progress; if (ACC 0x33) *nvm_rdy* = '1', then writing is completed. As long as the write process is ongoing, no change of power mode and image registers is allowed. Also, the NVM write cycle must not be initiated while image registers are updated, in low-power mode, and in suspend mode.

Please note that the number of permitted NVM write-cycles is limited as specified in table 2. The number of remaining write-cycles can be obtained by reading bits (ACC 0x33) *nvm_remain*.

5.6 Interrupt controller accelerometer

The accelerometer is equipped with eight programmable interrupt engines. Each interrupt can be independently enabled and configured. If the trigger condition of an enabled interrupt is fulfilled, the corresponding status bit is set to '1' and the selected interrupt pin is activated. The accelerometer provides two interrupt pins, INT1 and INT2; interrupts can be freely mapped to any of these pins. The state of a specific interrupt pin is derived from a logic 'or' combination of all interrupts mapped to it.

The interrupt status registers are updated when a new data word is written into the acceleration data registers. If an interrupt is disabled, all active status bits associated with it are immediately reset.

5.6.1 General features

An interrupt is cleared depending on the selected interrupt mode, which is common to all interrupts. There are three different interrupt modes: non-latched, latched, and temporary. The mode is selected by the (ACC 0x21) *latch_int* bits according to table 12.

Table 12: Interrupt mode selection

(ACC 0x21) <i>latch_int</i>	Interrupt mode
0000b	non-latched
0001b	temporary, 250ms
0010b	temporary, 500ms
0011b	temporary, 1s
0100b	temporary, 2s
0101b	temporary, 4s
0110b	temporary, 8s
0111b	latched
1000b	non-latched
1001b	temporary, 250µs
1010b	temporary, 500µs
1011b	temporary, 1ms
1100b	temporary, 12.5ms
1101b	temporary, 25ms
1110b	temporary, 50ms
1111b	latched

An interrupt is generated if its activation condition is met. It cannot be cleared as long as the activation condition is fulfilled. In the non-latched mode the interrupt status bit and the selected pin (the contribution to the 'or' condition for INT1 and/or INT2) are cleared as soon as the activation condition is no more valid. Exceptions to this behavior are the new data, orientation, and flat interrupts, which are automatically reset after a fixed time.

In latched mode an asserted interrupt status and the selected pin are cleared by writing '1' to bit (ACC 0x21) *reset_int*. If the activation condition still holds when it is cleared, the interrupt status is asserted again with the next change of the acceleration registers.

In the temporary mode an asserted interrupt and selected pin are cleared after a defined period of time. The behavior of the different interrupt modes is shown graphically in figure 6. The timings in this mode are subject to the same tolerances as the bandwidths (see table 2).

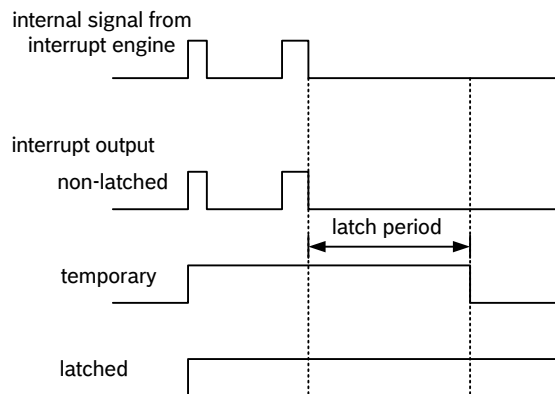

Figure 6: Interrupt modes

Several interrupt engines can use either unfiltered or filtered acceleration data as their input. For these interrupts, the source can be selected with the bits in register (*ACC 0x1E*). These are (*ACC 0x1E*) *int_src_data*, (*ACC 0x1E*) *int_src_tap*, (*ACC 0x1E*) *int_src_slo_no_mot*, (*ACC 0x1E*) *int_src_slope*, (*ACC 0x1E*) *int_src_high*, and (*ACC 0x1E*) *int_src_low*. Setting the respective bits to '0' ('1') selects filtered (unfiltered) data as input. The orientation recognition and flat detection interrupt always use filtered input data.

It is strongly recommended to set interrupt parameters prior to enabling the interrupt. Changing parameters of an already enabled interrupt may cause unwanted interrupt generation and generation of a false interrupt history. A safe way to change parameters of an enabled interrupt is to keep the following sequence: disable the desired interrupt, change parameters, wait for at least 10ms, and then re-enable the desired interrupt.

5.6.2 Mapping to physical interrupt pins (inttype to INT Pin#)

Registers (*ACC 0x19*) to (*ACC 0x1B*) are dedicated to mapping of interrupts to the interrupt pins "INT1" or "INT2". Setting (*ACC 0x19*) *int1_"inttype"* to '1' ('0') maps (unmaps) "inttype" to pin "INT1". Correspondingly setting (*ACC 0x1B*) *int2_"inttype"* to '1' ('0') maps (unmaps) "inttype" to pin "INT2".

Note: "inttype" to be replaced with the precise notation, given in the memory map in chapter 6.

Example: For flat interrupt (*int1_flat*): Setting (*ACC 0x19*) *int1_flat* to '1' maps *int1_flat* to pin "INT1".

5.6.3 Electrical behavior (INT pin# to open-drive or push-pull)

Both interrupt pins can be configured to show the desired electrical behavior. The 'active' level of each interrupt pin is determined by the (*ACC 0x20*) *int1_lvl* and (*ACC 0x20*) *int2_lvl* bits.

If (*ACC 0x20*) *int1_lvl* = '1' ('0') / (*ACC 0x20*) *int2_lvl* = '1' ('0'), then pin "INT1" / pin "INT2" is active '1' ('0'). The characteristic of the output driver of the interrupt pins may be configured with bits (*ACC 0x20*) *int1_od* and (*ACC 0x20*) *int2_od*. By setting bits (*ACC 0x20*) *int1_od* / (*ACC 0x20*) *int2_od* to '1', the output driver shows open-drive characteristic, by setting the configuration bits to '0', the output driver shows push-pull characteristic. When open-drive characteristic is selected in the design, external pull-up or pull-down resistor should be applied

according to the `int_lvl` configuration. When open-drive characteristic is selected in the design, external pull-up or pull-down resistor should be applied according to the `int_lvl` configuration.

5.6.4 New data interrupt

This interrupt serves for synchronous reading of acceleration data. It is generated after storing a new value of z-axis acceleration data in the data register. The interrupt is cleared automatically when the next data acquisition cycle starts. The interrupt status is '0' for at least 50µs.

The interrupt mode of the new data interrupt is fixed to non-latched.

It is enabled (disabled) by writing '1' ('0') to bit (`ACC 0x17`) `data_en`. The interrupt status is stored in bit (`ACC 0x0A`) `data_int`.

Due to the settling time of the filter, the first interrupt after wake-up from suspend or standby mode will take longer than the update time.

5.6.5 Slope / any-motion detection

Slope / any-motion detection uses the slope between successive acceleration signals to detect changes in motion. An interrupt is generated when the slope (absolute value of acceleration difference) exceeds a preset threshold. It is cleared as soon as the slope falls below the threshold. The principle is made clear in figure 7.

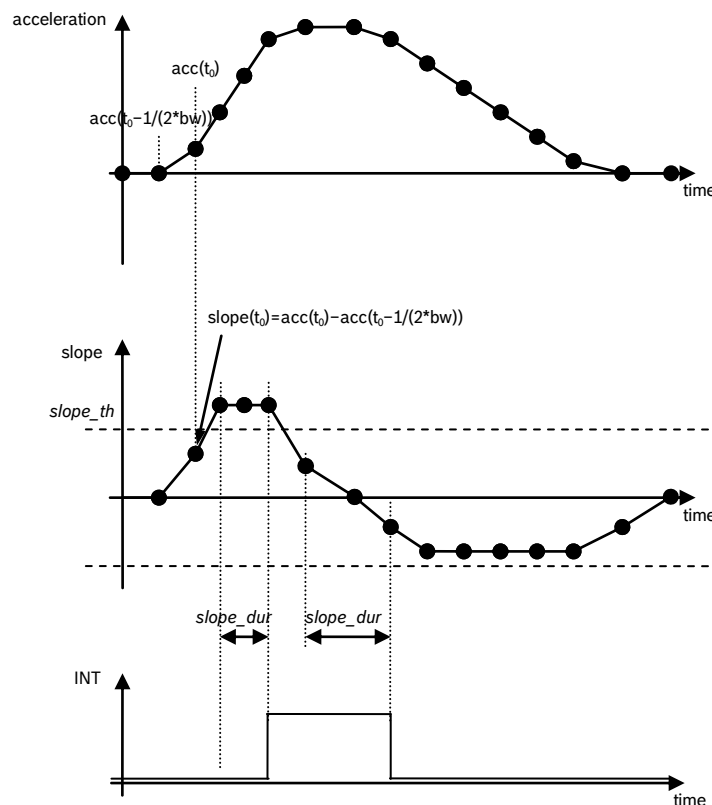

Figure 7: Principle of any-motion detection

The threshold is defined through register (ACC 0x28) *slope_th*. In terms of scaling 1 LSB of (ACC 0x28) *slope_th* corresponds to 3.91 mg in 2g-range (7.81 mg in 4g-range, 15.6 mg in 8g-range and 31.3 mg in 16g-range). Therefore the maximum value is 996 mg in 2g-range (1.99g in 4g-range, 3.98g in 8g-range and 7.97g in 16g-range).

The time difference between the successive acceleration signals depends on the selected bandwidth and equates to $1/(2 \cdot \text{bandwidth})$ ($t=1/(2 \cdot \text{bw})$). In order to suppress false triggers, the interrupt is only generated (cleared) if a certain number N of consecutive slope data points is larger (smaller) than the slope threshold given by (ACC 0x28) *slope_th*. This number is set by the (ACC 0x27) *slope_dur* bits. It is $N = (\text{ACC } 0x27) \text{ slope_dur} + 1$ for (ACC 0x27).

Example: (ACC 0x27) *slope_dur* = 00b, ..., 11b = 1decimal, ..., 4decimal.

5.6.5.1 Enabling (disabling) for each axis

Any-motion detection can be enabled (disabled) for each axis separately by writing '1' ('0') to bits (ACC 0x16) *slope_en_x*, (ACC 0x16) *slope_en_y*, (ACC 0x16) *slope_en_z*. The criteria for any-motion detection are fulfilled and the slope interrupt is generated if the slope of any of the enabled axes exceeds the threshold (ACC 0x28) *slope_th* for [(ACC 0x27) *slope_dur* + 1] consecutive times. As soon as the slopes of all enabled axes fall or stay below this threshold for [(ACC 0x27) *slope_dur* + 1] consecutive times the interrupt is cleared unless interrupt signal is latched.

5.6.5.2 Axis and sign information of slope / any motion interrupt

The interrupt status is stored in bit (ACC 0x09) *slope_int*. The any-motion interrupt supplies additional information about the detected slope. The axis which triggered the interrupt is given by that one of bits (ACC 0x0B) *slope_first_x*, (ACC 0x0B) *slope_first_y*, (ACC 0x0B) *slope_first_z* that contains a value of '1'. The sign of the triggering slope is held in bit (ACC 0x0B) *slope_sign* until the interrupt is retriggered. If (ACC 0x0B) *slope_sign* = '0' ('1'), the sign is positive (negative).

5.6.5.3 Tap sensing

Tap sensing has a functional similarity with a common laptop touch-pad or clicking keys of a computer mouse. A tap event is detected if a pre-defined slope of the acceleration of at least one axis is exceeded. Two different tap events are distinguished: A 'single tap' is a single event within a certain time, followed by a certain quiet time. A 'double tap' consists of a first such event followed by a second event within a defined time frame.

Single tap interrupt is enabled (disabled) by writing '1' ('0') to bit (ACC 0x16) *s_tap_en*. Double tap interrupt is enabled (disabled) by writing '1' ('0') to bit (ACC 0x16) *d_tap_en*.

The status of the single tap interrupt is stored in bit (ACC 0x09) *s_tap_int*, the status of the double tap interrupt is stored in bit (ACC 0x09) *d_tap_int*.

The slope threshold for detecting a tap event is set by bits (ACC 0x2B) *tap_th*. The meaning of (ACC 0x2B) *tap_th* depends on the range setting. 1 LSB of (ACC 0x2B) *tap_th* corresponds to a slope of 62.5mg in 2g-range, 125mg in 4g-range, 250mg in 8g-range, and 500mg in 16g-range.

In figure 8 the meaning of the different timing parameters is visualized:

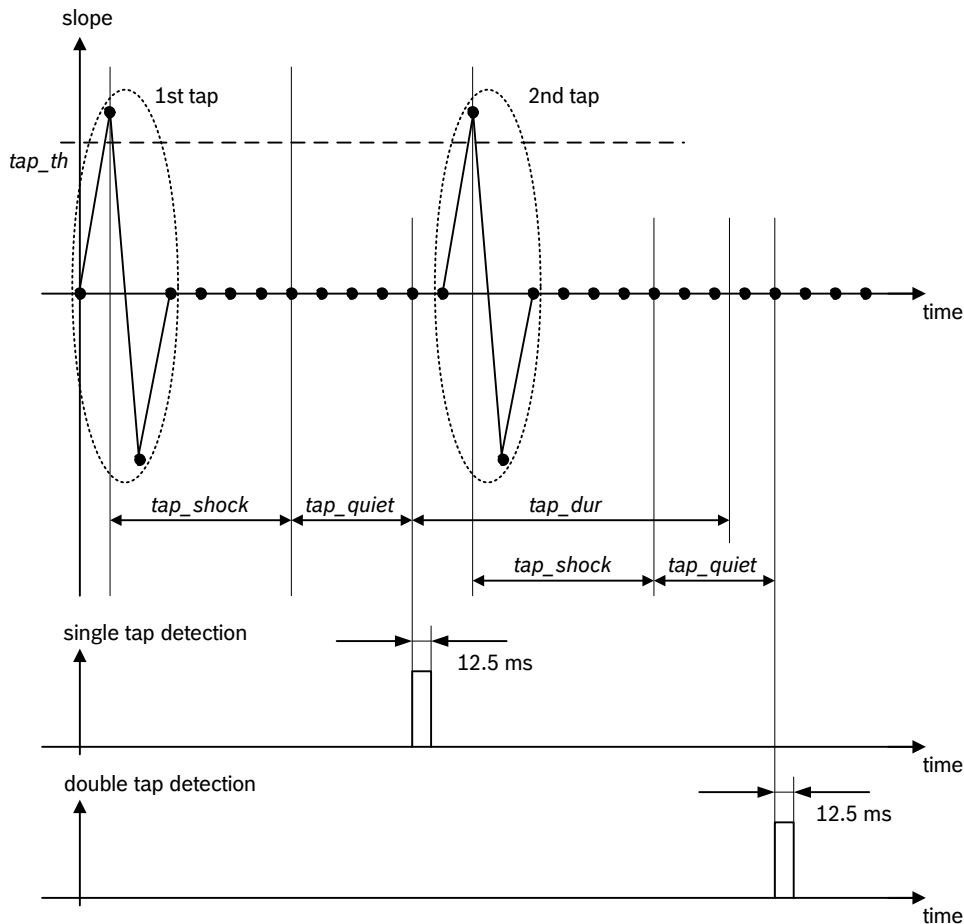

Figure 8: Timing of tap detection

The parameters (*ACC 0x2A*) *tap_shock* and (*ACC 0x2A*) *tap_quiet* apply to both single tap and double tap detection, while (*ACC 0x2A*) *tap_dur* applies to double tap detection only. Within the duration of (*ACC 0x2A*) *tap_shock* any slope exceeding (*ACC 0x2B*) *tap_th* after the first event is ignored. Contrary to this, within the duration of (*ACC 0x2A*) *tap_quiet* no slope exceeding (*ACC 0x2B*) *tap_th* must occur, otherwise the first event will be cancelled.

5.6.5.4 Single tap detection

A single tap is detected and the single tap interrupt is generated after the combined durations of (*ACC 0x2A*) *tap_shock* and (*ACC 0x2A*) *tap_quiet*, if the corresponding slope conditions are fulfilled. The interrupt is cleared after a delay of 12.5 ms.

Do not map single-tap to any INT pin if you do not want to use it.

5.6.5.5 Double tap detection

A double tap interrupt is generated if an event fulfilling the conditions for a single tap occurs within the set duration in (*ACC 0x2A*) *tap_dur* after the completion of the first tap event. The interrupt is automatically cleared after a delay of 12.5 ms.

5.6.5.6 Selecting the timing of tap detection

For each of parameters (ACC 0x2A) *tap_shock* and (ACC 0x2A) *tap_quiet* two values are selectable. By writing '0' ('1') to bit (ACC 0x2A) *tap_shock* the duration of (ACC 0x2A) *tap_shock* is set to 50 ms (75 ms). By writing '0' ('1') to bit (ACC 0x2A) *tap_quiet* the duration of (ACC 0x2A) *tap_quiet* is set to 30 ms (20 ms).

The length of (ACC 0x2A) *tap_dur* can be selected by setting the (ACC 0x2A) *tap_dur* bits according to table 13:

Table 13: Selection of *tap_dur*

(ACC 0x2A) <i>tap_dur</i>	length of <i>tap_dur</i>
000b	50 ms
001b	100 ms
010b	150 ms
011b	200 ms
100b	250 ms
101b	375 ms
110b	500 ms
111b	700 ms

5.6.5.7 Axis and sign information of tap sensing

The sign of the slope of the first tap which triggered the interrupt is stored in bit (ACC 0x0B) *tap_sign* ('0' means positive sign, '1' means negative sign). The value of this bit persists after clearing the interrupt.

The axis which triggered the interrupt is indicated by bits (ACC 0x0B) *tap_first_x*, (ACC 0x0B) *tap_first_y*, and (ACC 0x0B) *tap_first_z*.

The bit corresponding to the triggering axis contains a '1' while the other bits hold a '0'. These bits are cleared together with clearing the interrupt status.

5.6.5.8 Tap sensing in low power mode

In low-power mode, a limited number of samples is processed after wake-up to decide whether an interrupt condition is fulfilled. The number of samples is selected by bits (ACC 0x2B) *tap_samp* according to table 14.

Table 14: Meaning of (ACC 0x2B) *tap_samp*

(ACC 0x2B) <i>tap_samp</i>	Number of Samples
00b	2
01b	4
10b	8
11b	16

5.6.6 Orientation recognition

The orientation recognition feature informs on an orientation change of the sensor with respect to the gravitational field vector 'g'. The measured acceleration vector components with respect to the gravitational field are defined as shown in figure 9.

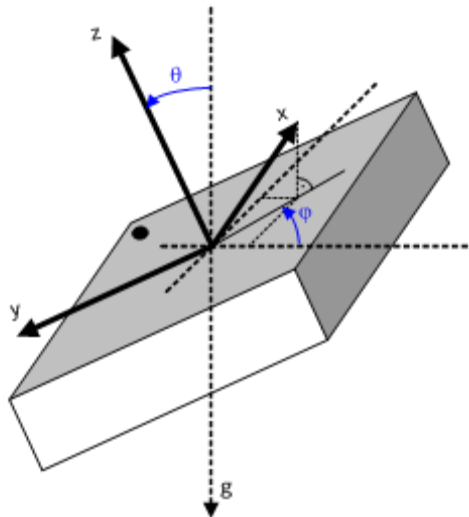

Figure 9: Definition of vector components

Therefore, the magnitudes of the acceleration vectors are calculated as follows:

$$\begin{aligned} \text{acc_x} &= 1g \times \sin\theta \times \cos\varphi \\ \text{acc_y} &= -1g \times \sin\theta \times \sin\varphi \\ \text{acc_z} &= 1g \times \cos\theta \\ \text{acc_y}/\text{acc_x} &= -\tan\varphi \end{aligned}$$

Depending on the magnitudes of the acceleration vectors the orientation of the device in the space is determined and stored in the three (*ACC 0x0C*) *orient* bits. These bits may not be reset in the sleep phase of low-power mode. There are three orientation calculation modes with different thresholds for switching between different orientations: symmetrical, high-asymmetrical, and low-asymmetrical. The mode is selected by setting the (*ACC 0x2C*) *orient_mode* bits as given in table 15.

Table 15: Orientation mode settings

<i>(ACC 0x2C)</i> <i>orient_mode</i>	Orientation Mode
00b	symmetrical
01b	high-asymmetrical
10b	low-asymmetrical
11b	symmetrical



For each orientation mode the (ACC 0x0C) *orient* bits have a different meaning as shown in table 16 to table 18:

Table 16: Meaning of the (ACC 0x0C) *orient* bits in symmetrical mode

(ACC 0x0C) <i>orient</i>	Name	Angle	Condition
x00	portrait upright	$315^\circ < \varphi < 45^\circ$	$ \text{acc_y} < \text{acc_x} - \text{'hyst'}$ and $\text{acc_x} - \text{'hyst'} \geq 0$
x01	portrait upside down	$135^\circ < \varphi < 225^\circ$	$ \text{acc_y} < \text{acc_x} - \text{'hyst'}$ and $\text{acc_x} + \text{'hyst'} < 0$
x10	landscape left	$45^\circ < \varphi < 135^\circ$	$ \text{acc_y} \geq \text{acc_x} + \text{'hyst'}$ and $\text{acc_y} < 0$
x11	landscape right	$225^\circ < \varphi < 315^\circ$	$ \text{acc_y} \geq \text{acc_x} + \text{'hyst'}$ and $\text{acc_y} \geq 0$

Table 17: Meaning of the (ACC 0x0C) *orient* bits in high-asymmetrical mode

(ACC 0x0C) <i>orient</i>	Name	Angle	Condition
x00	portrait upright	$297^\circ < \varphi < 63^\circ$	$ \text{acc_y} < 2 \cdot \text{acc_x} - \text{'hyst'}$ and $\text{acc_x} - \text{'hyst'} \geq 0$
x01	portrait upside down	$117^\circ < \varphi < 243^\circ$	$ \text{acc_y} < 2 \cdot \text{acc_x} - \text{'hyst'}$ and $\text{acc_x} + \text{'hyst'} < 0$
x10	landscape left	$63^\circ < \varphi < 117^\circ$	$ \text{acc_y} \geq 2 \cdot \text{acc_x} + \text{'hyst'}$ and $\text{acc_y} < 0$
x11	landscape right	$243^\circ < \varphi < 297^\circ$	$ \text{acc_y} \geq 2 \cdot \text{acc_x} + \text{'hyst'}$ and $\text{acc_y} \geq 0$

Table 18: Meaning of the (ACC 0x0C) *orient* bits in low-asymmetrical mode

(ACC 0x0C) <i>orient</i>	Name	Angle	Condition
x00	portrait upright	$333^\circ < \varphi < 27^\circ$	$ \text{acc_y} < 0.5 \cdot \text{acc_x} - \text{'hyst'}$ and $\text{acc_x} - \text{'hyst'} \geq 0$
x01	portrait upside down	$153^\circ < \varphi < 207^\circ$	$ \text{acc_y} < 0.5 \cdot \text{acc_x} - \text{'hyst'}$ and $\text{acc_x} + \text{'hyst'} < 0$
x10	landscape left	$27^\circ < \varphi < 153^\circ$	$ \text{acc_y} \geq 0.5 \cdot \text{acc_x} + \text{'hyst'}$ and $\text{acc_y} < 0$
x11	landscape right	$207^\circ < \varphi < 333^\circ$	$ \text{acc_y} \geq 0.5 \cdot \text{acc_x} + \text{'hyst'}$ and $\text{acc_y} \geq 0$

In the preceding tables, the parameter 'hyst' stands for a hysteresis, which can be selected by setting the (ACC 0x2C) *orient_hyst* bits. 1 LSB of (ACC 0x2C) *orient_hyst* always corresponds to 62.5 mg, in any g-range (i.e. increment is independent from g-range setting). It is important to note that by using a hysteresis $\neq 0$ the actual switching angles become different from the angles given in the tables since there is an overlap between the different orientations.

The most significant bit of the (*ACC 0x0C*) *orient* bits (which is displayed as an 'x' in the above given tables) contains information about the direction of the z-axis. It is set to '0' ('1') if $\text{acc_z} \geq 0$ ($\text{acc_z} < 0$).

Figure 10 shows the typical switching conditions between the four different orientations for the symmetrical mode i.e. without hysteresis:

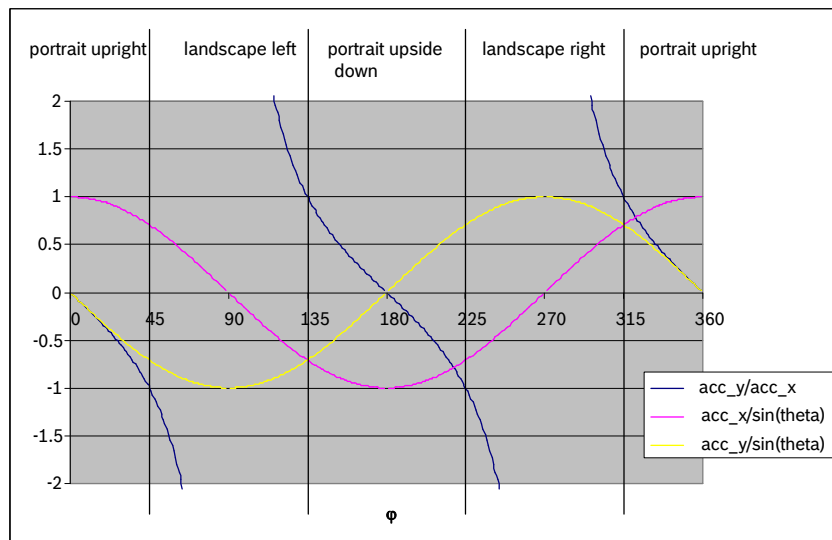

Figure 10: Typical orientation switching conditions w/o hysteresis

The orientation interrupt is enabled (disabled) by writing '1' ('0') to bit (*ACC 0x16*) *orient_en*. The interrupt is generated if the value of (*ACC 0x0C*) *orient* has changed. It is automatically cleared after one stable period of the (*ACC 0x0C*) *orient* value. The interrupt status is stored in the (*ACC 0x09*) *orient_int* bit. The register (*ACC 0x0C*) *orient* always reflects the current orientation of the device, irrespective of which interrupt mode has been selected. Bit (*ACC 0x0C*) *orient*<2> reflects the device orientation with respect to the z-axis. The bits (*ACC 0x0C*) *orient*<1:0> reflect the device orientation in the x-y-plane. The conventions associated with register (*ACC 0x0C*) *orient* are detailed in chapter 6.

5.6.6.1 Orientation blocking

The change of the (*ACC 0x0C*) *orient* value and – as a consequence – the generation of the interrupt can be blocked according to conditions selected by setting the value of the (*ACC 0x2C*) *orient_blocking* bits as described by table 19.

Table 19: Blocking conditions for orientation recognition

(ACC 0x2C) <i>orient_blocking</i>	Conditions
00b	no blocking
01b	theta blocking or acceleration in any axis > 1.5g
10b	theta blocking or acceleration slope in any axis > 0.2 g or acceleration in any axis > 1.5g
11b	theta blocking or acceleration slope in any axis > 0.4 g or acceleration in any axis > 1.5g and value of orient is not stable for at least 100 ms

The theta blocking is defined by the following inequality:

$$|\tan \theta| < \frac{\sqrt{\text{blocking_theta}}}{8}$$

The parameter *blocking_theta* of the above given equation stands for the contents of the (ACC 0x2D) *orient_theta* bits. It is possible to define a blocking angle between 0° and 44.8°. The internal blocking algorithm saturates the acceleration values before further processing. As a consequence, the blocking angles are strictly valid only for a device at rest; they can be different if the device is moved.

Example:

To get a maximum blocking angle of 19° the parameter *blocking_theta* is determined in the following way: $(8 * \tan(19^\circ))^2 = 7.588$, therefore, *blocking_value* = 8dec = 001000b has to be chosen.

In order to avoid unwanted generation of the orientation interrupt in a nearly flat position ($z \sim 0$, sign change due to small movements or noise), a hysteresis of 0.2 g is implemented for the z-axis, i. e. a after a sign change the interrupt is only generated after $|z| > 0.2$ g.

5.6.6.2 Up-Down Interrupt Suppression Flag

Per default an orientation interrupt is triggered when any of the bits in register (ACC 0x0C) *orient* changes state. The accelerometer can be configured to trigger orientation interrupts only when the device position changes in the x-y-plane while orientation changes with respect to the z-axis are ignored. A change of the orientation of the z-axis, and hence a state change of bit (ACC 0x0C) *orient<2>* is ignored (considered) when bit (ACC 0x2D) *orient_ud_en* is set to '0' ('1').

5.6.7 Flat detection

The flat detection feature gives information about the orientation of the devices' z-axis relative to the g-vector, i. e. it recognizes whether the device is in a flat position or not.

The flat angle Θ is adjustable by (0x2E) *flat_theta* from 0° to 44.8°. The flat angle can be set according to following formula:

$$\Theta = \text{atan}\left(\frac{1}{8}\sqrt{\text{flat_theta}}\right)$$

A hysteresis of the flat detection can be enabled by (0x2F) *flat_hy* bits. In this case the flat position is set if the angle drops below following threshold:

$$\Theta_{\text{hyst, ll}} = \text{atan}\left(\frac{1}{8}\sqrt{\text{flat_theta} \cdot \left(1 - \frac{\text{flat_hy}}{1024}\right) - \frac{\text{flat_hy}}{16}}\right)$$

The flat position is reset if the angle exceeds the following threshold:

$$\Theta_{\text{hyst, ul}} = \text{atan}\left(\frac{1}{8}\sqrt{\text{flat_theta} \cdot \left(1 + \frac{\text{flat_hy}}{1024}\right) + \frac{\text{flat_hy}}{16}}\right)$$

The flat interrupt is enabled (disabled) by writing '1' ('0') to bit (ACC 0x16) *flat_en*. The flat value is stored in the (ACC 0x0C) *flat* bit if the interrupt is enabled. This value is '1' if the device is in the flat position, it is '0' otherwise. The flat interrupt is generated if the flat value has changed and the new value is stable for at least the time given by the (ACC 0x2F) *flat_hold_time* bits. A flat interrupt may be also generated if the flat interrupt is enabled. The actual status of the interrupt is stored in the (ACC 0x09) *flat_int* bit. The flat orientation of the sensor can always be determined from reading the (ACC 0x0C) *flat* bit after interrupt generation. If unlatched interrupt mode is used, the (ACC 0x09) *flat_int* value and hence the interrupt is automatically cleared after one sample period. If temporary or latched interrupt mode is used, the (ACC 0x09) *flat_int* value is kept fixed until the latch time expires or the interrupt is reset.

The meaning of the (ACC 0x2F) *flat_hold_time* bits can be seen from table 20.

Table 20: Meaning of *flat_hold_time*

(ACC 0x2F) <i>flat_hold_time</i>	Time
00b	0
01b	512 ms
10b	1024 ms
11b	2048 ms

5.6.8 Low-g interrupt

This interrupt is based on the comparison of acceleration data against a low-g threshold, which is most useful for free-fall detection.

The interrupt is enabled (disabled) by writing '1' ('0') to the (*ACC 0x17*) *low_en* bit. There are two modes available, 'single' mode and 'sum' mode. In 'single' mode, the acceleration of each axis is compared with the threshold; in 'sum' mode, the sum of absolute values of all accelerations $|acc_x| + |acc_y| + |acc_z|$ is compared with the threshold. The mode is selected by the contents of the (*ACC 0x24*) *low_mode* bit: '0' means 'single' mode, '1' means 'sum' mode.

The low-g threshold is set through the (*ACC 0x23*) *low_th* register. 1 LSB of (*ACC 0x23*) *low_th* always corresponds to an acceleration of 7.81 mg (i.e. increment is independent from g-range setting).

A hysteresis can be selected by setting the (*ACC 0x24*) *low_hy* bits. 1 LSB of (*ACC 0x24*) *low_hy* always corresponds to an acceleration difference of 125 mg in any g-range (as well, increment is independent from g-range setting).

The low-g interrupt is generated if the absolute values of the acceleration of all axes ('and' relation, in case of single mode) or their sum (in case of sum mode) are lower than the threshold for at least the time defined by the (*ACC 0x22*) *low_dur* register. The interrupt is reset if the absolute value of the acceleration of at least one axis ('or' relation, in case of single mode) or the sum of absolute values (in case of sum mode) is higher than the threshold plus the hysteresis for at least one data acquisition. In bit (*ACC 0x09*) *low_int* the interrupt status is stored.

The relation between the content of (*ACC 0x22*) *low_dur* and the actual delay of the interrupt generation is: $\text{delay [ms]} = [(ACC\ 0x22)\ low_dur + 1] \cdot 2\ \text{ms}$. Therefore, possible delay times range from 2 ms to 512 ms.

5.6.9 High-g interrupt

This interrupt is based on the comparison of acceleration data against a high-g threshold for the detection of shock or other high-acceleration events.

The high-g interrupt is enabled (disabled) per axis by writing '1' ('0') to bits (*ACC 0x17*) *high_en_x*, (*ACC 0x17*) *high_en_y*, and (*ACC 0x17*) *high_en_z*, respectively. The high-g threshold is set through the (*ACC 0x26*) *high_th* register. The meaning of an LSB of (*ACC 0x26*) *high_th* depends on the selected g-range: it corresponds to 7.81 mg in 2g-range, 15.63 mg in 4g-range, 31.25 mg in 8g-range, and 62.5 mg in 16g-range (i.e. increment depends from g-range setting).

A hysteresis can be selected by setting the (*ACC 0x24*) *high_hy* bits. Analogously to (*ACC 0x26*) *high_th*, the meaning of an LSB of (*ACC 0x24*) *high_hy* is g-range dependent: It corresponds to an acceleration difference of 125 mg in 2g-range, 250 mg in 4g-range, 500 mg in 8g-range, and 1000mg in 16g-range (as well, increment depends from g-range setting).

The high-g interrupt is generated if the absolute value of the acceleration of at least one of the enabled axes ('or' relation) is higher than the threshold for at least the time defined by the (*ACC 0x25*) *high_dur* register. The interrupt is reset if the absolute value of the acceleration of all

enabled axes ('and' relation) is lower than the threshold minus the hysteresis for at least the time defined by the (ACC 0x25) *high_dur* register. In bit (ACC 0x09) *high_int* the interrupt status is stored. The relation between the content of (ACC 0x25) *high_dur* and the actual delay of the interrupt generation is $\text{delay [ms]} = [(ACC\ 0x22)\ \textit{low_dur} + 1] \cdot 2\ \text{ms}$. Therefore, possible delay times range from 2 ms to 512 ms. The interrupt will be cleared immediately once acceleration is lower than threshold.

5.6.9.1 Axis and sign information of high-g interrupt

The axis which triggered the interrupt is indicated by bits (ACC 0x0C) *high_first_x*, (ACC 0x0C) *high_first_y*, and (ACC 0x0C) *high_first_z*. The bit corresponding to the triggering axis contains a '1' while the other bits hold a '0'. These bits are cleared together with clearing the interrupt status. The sign of the triggering acceleration is stored in bit (ACC 0x0C) *high_sign*. If (ACC 0x0C) *high_sign* = '0' ('1'), the sign is positive (negative).

5.6.10 No-motion / slow motion detection

The slow-motion/no-motion interrupt engine can be configured in two modes.

In slow-motion mode an interrupt is triggered when the measured slope of at least one enabled axis exceeds the programmable slope threshold for a programmable number of samples. Hence the engine behaves similar to the any-motion interrupt, but with a different set of parameters. In order to suppress false triggers, the interrupt is only generated (cleared) if a certain number *N* of consecutive slope data points is larger (smaller) than the slope threshold given by (ACC 0x27) *slo_no_mot_dur<1:0>*. The number is $N = (ACC\ 0x27)\ \textit{slo_no_mot_dur<1:0>} + 1$.

In no-motion mode an interrupt is generated if the slope on all selected axes remains smaller than a programmable threshold for a programmable delay time. Figure 11 shows the timing diagram for the no-motion interrupt. The scaling of the threshold value is identical to that of the slow-motion interrupt. However, in no-motion mode register (ACC 0x27) *slo_no_mot_dur* defines the delay time before the no-motion interrupt is triggered. Table 21 lists the delay times adjustable with register (ACC 0x27) *slo_no_mot_dur*. The timer tick period is 1 second. Hence using short delay times can result in considerable timing uncertainty.

If bit (ACC 0x18) *slo_no_mot_sel* is set to '1' ('0') the no-motion/slow-motion interrupt engine is configured in the no-motion (slow-motion) mode. Common to both modes, the engine monitors the slopes of the axes that have been enabled with bits (ACC 0x18) *slo_no_mot_en_x*, (ACC 0x18) *slo_no_mot_en_y*, and (ACC 0x18) *slo_no_mot_en_z* for the x-axis, y-axis and z-axis, respectively. The measured slope values are continuously compared against the threshold value defined in register (ACC 0x29) *slo_no_mot_th*. The scaling is such that 1 LSB of (ACC 0x29) *slo_no_mot_th* corresponds to 3.91 mg in 2g-range (7.81 mg in 4g-range, 15.6 mg in 8g-range and 31.3 mg in 16g-range). Therefore the maximum value is 996 mg in 2g-range (1.99g in 4g-range, 3.98g in 8g-range and 7.97g in 16g-range). The time difference between the successive acceleration samples depends on the selected bandwidth and equates to $1/(2 \cdot \textit{bw})$.

Table 21: No-motion time-out periods

(ACC 0x27) <i>slo_no_mot_dur</i>	Delay time	(ACC 0x27) <i>slo_no_mot_dur</i>	Delay time	(ACC 0x27) <i>slo_no_mot_dur</i>	Delay Time
0	1 s	16	40 s	32	88 s
1	2 s	17	48 s	33	96 s
2	3 s	18	56 s	34	104 s
...	...	19	64 s
14	15 s	20	72 s	62	328 s
15	16 s	21	80 s	63	336 s

Note: *slo_no_mot_dur* values 22 to 31 are not specified

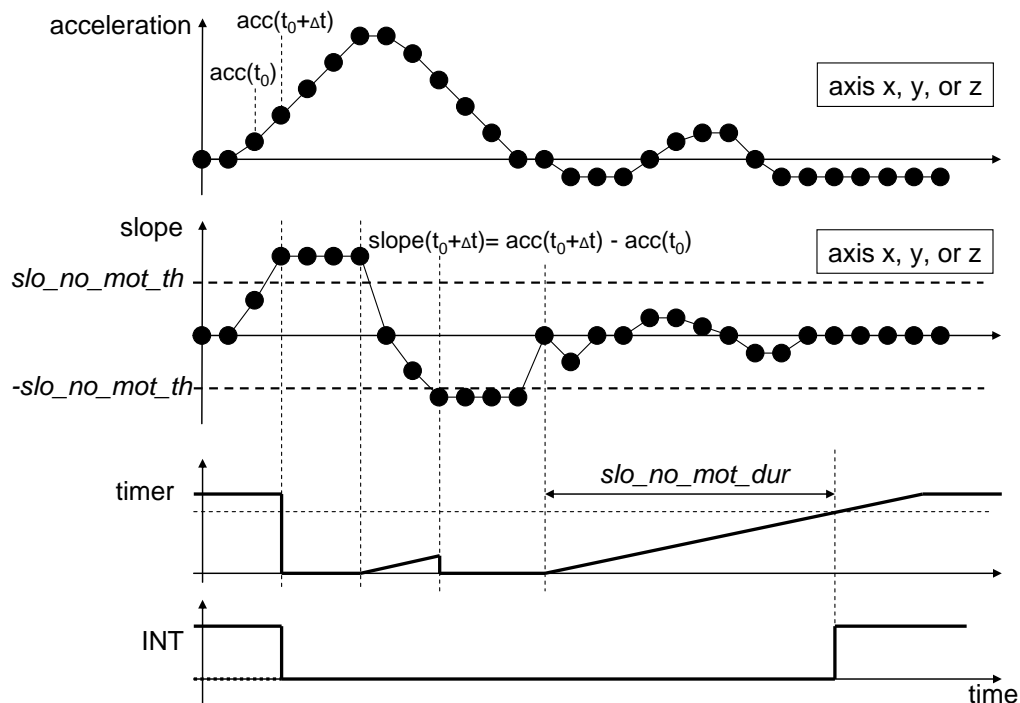

Figure 11: Timing of no-motion interrupt

5.7 Softreset accelerometer

A softreset causes all user configuration settings to be overwritten with their default value and the sensor to enter normal mode.

A softreset is initiated by means of writing value '0xB6' to register (ACC 0x14) *softreset*. Subsequently a waiting time of $t_{w,up1}$ (max.) is required prior to accessing any configuration register.

6. Register description accelerometer

6.1 General remarks accelerometer

The entire communication with the device is performed by reading from and writing to registers. Registers have a width of 8 bits; they are mapped to a common space of 64 addresses from (ACC 0x00) up to (ACC 0x3F). Within the used range there are several registers which are either completely or partially marked as 'reserved'. Any reserved bit is ignored when it is written and no specific value is guaranteed when read. It is recommended not to use registers at all which are completely marked as 'reserved'. Furthermore it is recommended to mask out (logical *and* with zero) reserved bits of registers which are partially marked as reserved.

Registers with addresses from (ACC 0x00) up to (ACC 0x0E) are read-only. Any attempt to write to these registers is ignored. There are bits within some registers that trigger internal sequences. These bits are configured for write-only access, e. g. (ACC 0x21) *reset_int* or the entire (ACC 0x14) *softreset* register, and read as value '0'.

6.2 Register map accelerometer

Register Address	bit7	bit6	bit5	bit4	bit3	bit2	bit1	bit0	Access	Default		
0x3F	fifo_data_output_register<7:0>								ro	0x00		
0x3E	fifo_mode<1:0>							fifo_data_select<1:0>		w/r	0x00	
0x3D									w/r	0xFF		
0x3C	GP1<7:0>								w/r	0x00		
0x3B	GP0<7:0>								w/r	0x00		
0x3A	offset_z<7:0>								w/r	0x00		
0x39	offset_y<7:0>								w/r	0x00		
0x38	offset_x<7:0>								w/r	0x00		
0x37	offset_target_z<1:0>			offset_target_y<1:0>		offset_target_x<1:0>		cut_off		w/r	0x00	
0x36	offset_reset	cal_trigger<1:0>		cal_rdy	hp_z_en		hp_y_en	hp_x_en	w/r	0x10		
0x35									w/r	0x00		
0x34									w/r	0x00		
0x33	nvm_remain<3:0>				nvm_load	i2c_wdt_en	i2c_wdt_sel	spi3		w/r	0x00	
0x32					self_test_amp	self_test_sign		self_test_axis<1:0>		w/r	0x00	
0x31									w/r	0xFF		
0x30	fifo_water_mark_level_trigger_retain<5:0>								w/r	0x00		
0x2F	flat_hold_time<1:0>							flat_hy<2:0>		w/r	0x11	
0x2E	flat_theta<5:0>								w/r	0x08		
0x2D	orient_theta<5:0>								w/r	0x48		
0x2C	orient_ud_en			orient_hyst<2:0>		orient_blocking<1:0>		orient_mode<1:0>		w/r	0x18	
0x2B	tap_samp<1:0>							tap_th<4:0>		w/r	0x0A	
0x2A	tap_quiet	tap_shock					tap_dur<2:0>		w/r	0x04		
0x29	slo_no_mot_th<7:0>								w/r	0x14		
0x28	slope_th<7:0>								w/r	0x14		
0x27	slo_no_mot_dur<5:0>								w/r	0x00		
0x26	high_th<7:0>								w/r	0xC0		
0x25	high_dur<7:0>								w/r	0x0F		
0x24	high_hy<1:0>						low_mode	low_hy<1:0>		w/r	0x81	
0x23	low_th<7:0>								w/r	0x30		
0x22	low_dur<7:0>								w/r	0x09		
0x21	reset_int					latch_int<3:0>				w/r	0x00	
0x20					int2_od	int2_lm	int1_od	int1_lm		w/r	0x05	
0x1F									w/r	0xFF		
0x1E	int_src_data			int_src_tap	int_src_slo_no_mot	int_src_slope	int_src_high	int_src_low		w/r	0x00	
0x1D									w/r	0xFF		
0x1C									w/r	0xFF		
0x1B	int2_flat	int2_orient	int2_s_tap	int2_d_tap	int2_slo_no_mot	int2_slope	int2_high	int2_low		w/r	0x00	
0x1A	int2_data	int2_fwm	int2_ffull			int1_ffull	int1_fwm	int1_data		w/r	0x00	
0x19	int1_flat	int1_orient	int1_s_tap	int1_d_tap	int1_slo_no_mot	int1_slope	int1_high	int1_low		w/r	0x00	
0x18					slo_no_mot_sel	slo_no_mot_en_z	slo_no_mot_en_y	slo_no_mot_en_x		w/r	0x00	
0x17	int_fwm_en		int_ffull_en	data_en	low_en		high_en_z	high_en_y	high_en_x	w/r	0x00	
0x16	flat_en	orient_en	s_tap_en	d_tap_en			slope_en_z	slope_en_y	slope_en_x	w/r	0x00	
0x15									w/r	0xFF		
0x14	softreset								wo	0x00		
0x13	data_high_bw	shadow_dis							w/r	0x00		
0x12	lowpower_mode		sleeptimer_mode							w/r	0x00	
0x11	suspend	lowpower_en	deep_suspend	sleep_dur<3:0>						w/r	0x00	
0x10									w/r	0x0F		
0x0F					bw<4:0>				w/r	0x03		
0x0E	fifo_overrun	fifo_frame_counter<6:0>						range<3:0>		ro	0x00	
0x0D									w/r	0xFF		
0x0C	flat	orient<2:0>			high_sign	high_first_z	high_first_y	high_first_x		ro	0x00	
0x0B	tap_sign	tap_first_z	tap_first_y	tap_first_x	slope_sign	slope_first_z	slope_first_y	slope_first_x		ro	0x00	
0x0A	data_int	fifo_wm_int	fifo_full_int								ro	0x00
0x09	flat_int	orient_int	s_tap_int	d_tap_int	slo_no_mot_int	slope_int	high_int	low_int		ro	0x00	
0x08	temp<7:0>								ro	0x00		
0x07	acc_z_msb<11:4>								ro	0x00		
0x06	acc_z_lsb<3:0>								new_data_z	ro	0x00	
0x05	acc_y_msb<11:4>								ro	0x00		
0x04	acc_y_lsb<3:0>								new_data_y	ro	0x00	
0x03	acc_x_msb<11:4>								ro	0x00		
0x02	acc_x_lsb<3:0>								new_data_x	ro	0x00	
0x01									ro	--		
0x00	chip_id<7:0>								ro	0xFA		

common w/r registers: Application specific settings which are not equal to the default settings, must be re-set to its designated values after POR, soft-reset and wake up from deep suspend.

user w/r registers: Initial default content = 0x00. Freely programmable by the user. Remains unchanged after POR, soft-reset and wake up from deep suspend.

Figure 12: Register map accelerometer part

ACC Register 0x00 (BGW_CHIPID)

The register contains the chip identification code.

Name	0x00	BGW_CHIPID		
Bit	7	6	5	4
Read/Write	R	R	R	R
Reset Value	n/a	n/a	n/a	n/a
Content	chip_id<7:4>			
Bit	3	2	1	0
Read/Write	R	R	R	R
Reset Value	n/a	n/a	n/a	n/a
Content	chip_id<3:0>			

chip_id<7:0>: Fixed value b'1111'1010

ACC Register 0x01 is reserved

ACC Register 0x02 (ACCD_X_LSB)

The register contains the least-significant bits of the X-channel acceleration readout value. When reading out X-channel acceleration values, data consistency is guaranteed if the ACCD_X_LSB is read out before the ACCD_X_MSB and shadow_dis='0'. In this case, after the ACCD_X_LSB has been read, the value in the ACCD_X_MSB register is locked until the ACCD_X_MSB has been read. This condition is inherently fulfilled if a burst-mode read access is performed. Acceleration data may be read from register ACCD_X_LSB at any time except during power-up and in DEEP_SUSPEND mode.

Name	0x02	ACCD_X_LSB		
Bit	7	6	5	4
Read/Write	R	R	R	R
Reset Value	n/a	n/a	n/a	n/a
Content	acc_x_lsb<3:0>			
Bit	3	2	1	0
Read/Write	R	R	R	R
Reset Value	n/a	n/a	n/a	n/a
Content	undefined	undefined	undefined	new_data_x

acc_x_lsb<3:0>: Least significant 4 bits of acceleration read-back value; (two's-complement format)

undefined: random data; to be ignored.

new_data_x: '0': acceleration value has not been updated since it has been read out last
 '1': acceleration value has been updated since it has been read out last

ACC Register 0x03 (ACCD_X_MSB)

The register contains the most-significant bits of the X-channel acceleration readout value. When reading out X-channel acceleration values, data consistency is guaranteed if the ACCD_X_LSB is read out before the ACCD_X_MSB and shadow_dis='0'. In this case, after the ACCD_X_LSB has been read, the value in the ACCD_X_MSB register is locked until the ACCD_X_MSB has been read. This condition is inherently fulfilled if a burst-mode read access is performed. Acceleration data may be read from register ACCD_X_MSB at any time except during power-up and in DEEP_SUSPEND mode.

Name	0x02	ACCD_X_MSB		
Bit	7	6	5	4
Read/Write	R	R	R	R
Reset Value	n/a	n/a	n/a	n/a
Content	acc_x_msb<11:8>			
Bit	3	2	1	0
Read/Write	R	R	R	R
Reset Value	n/a	n/a	n/a	n/a
Content	acc_x_msb<7:4>			

acc_x_msb<11:4>: Most significant 8 bits of acceleration read-back value (two's-complement format)

ACC Register 0x04 (ACCD_Y_LSB)

The register contains the least-significant bits of the Y-channel acceleration readout value. When reading out Y-channel acceleration values, data consistency is guaranteed if the ACCD_Y_LSB is read out before the ACCD_Y_MSB and shadow_dis='0'. In this case, after the ACCD_Y_LSB has been read, the value in the ACCD_Y_MSB register is locked until the ACCD_Y_MSB has been read. This condition is inherently fulfilled if a burst-mode read access is performed. Acceleration data may be read from register ACCD_Y_LSB at any time except during power-up and in DEEP_SUSPEND mode.

Name	0x04	ACCD_Y_LSB		
Bit	7	6	5	4
Read/Write	R	R	R	R
Reset Value	n/a	n/a	n/a	n/a
Content	acc_y_lsb<3:0>			
Bit	3	2	1	0
Read/Write	R	R	R	R
Reset Value	n/a	n/a	n/a	n/a
Content	undefined	undefined	undefined	new_data_y

acc_y_lsb<3:0>: Least significant 4 bits of acceleration read-back value; (two's-complement format)

undefined: random data; to be ignored

new_data_y: '0': acceleration value has not been updated since it has been read out last
 '1': acceleration value has been updated since it has been read out last

ACC Register 0x05 (ACCD_Y_MSB)

The register contains the most-significant bits of the Y-channel acceleration readout value. When reading out Y-channel acceleration values, data consistency is guaranteed if the ACCD_Y_LSB is read out before the ACCD_Y_MSB and shadow_dis='0'. In this case, after the ACCD_Y_LSB has been read, the value in the ACCD_Y_MSB register is locked until the ACCD_Y_MSB has been read. This condition is inherently fulfilled if a burst-mode read access is performed. Acceleration data may be read from register ACCD_Y_MSB at any time except during power-up and in DEEP_SUSPEND mode.

Name	0x05	ACCD_Y_MSB		
Bit	7	6	5	4
Read/Write	R	R	R	R
Reset Value	n/a	n/a	n/a	n/a
Content	acc_y_msb<11:8>			
Bit	3	2	1	0
Read/Write	R	R	R	R
Reset Value	n/a	n/a	n/a	n/a
Content	acc_y_msb<7:4>			

acc_y_msb<11:4>: Most significant 8 bits of acceleration read-back value (two's-complement format)

ACC Register 0x06 (ACCD_Z_LSB)

The register contains the least-significant bits of the Z-channel acceleration readout value. When reading out Z-channel acceleration values, data consistency is guaranteed if the ACCD_Z_LSB is read out before the ACCD_Z_MSB and shadow_dis='0'. In this case, after the ACCD_Z_LSB has been read, the value in the ACCD_Z_MSB register is locked until the ACCD_Z_MSB has been read. This condition is inherently fulfilled if a burst-mode read access is performed. Acceleration data may be read from register ACCD_Z_LSB at any time except during power-up and in DEEP_SUSPEND mode.

Name	0x06	ACCD_Z_LSB		
Bit	7	6	5	4
Read/Write	R	R	R	R
Reset Value	n/a	n/a	n/a	n/a
Content	acc_z_lsb<3:0>			

Bit	3	2	1	0
Read/Write	R	R	R	R
Reset Value	n/a	n/a	n/a	n/a
Content	undefined	undefined	undefined	new_data_z

Acc_z_lsb<3:0>: Least significant 4 bits of acceleration read-back value; (two's-complement format)

undefined: random data; to be ignored

new_data_z: '0': acceleration value has not been updated since it has been read out last
 '1': acceleration value has been updated since it has been read out last

ACC Register 0x07 (ACCD_Z_MSB)

The register contains the most-significant bits of the Z-channel acceleration readout value. When reading out Z-channel acceleration values, data consistency is guaranteed if the ACCD_Z_LSB is read out before the ACCD_Z_MSB and shadow_dis='0'. In this case, after the ACCD_Z_LSB has been read, the value in the ACCD_Z_MSB register is locked until the ACCD_Z_MSB has been read. This condition is inherently fulfilled if a burst-mode read access is performed. Acceleration data may be read from register ACCD_Z_MSB at any time except during power-up and in DEEP_SUSPEND mode.

Name	0x07	ACCD_Z_MSB		
Bit	7	6	5	4
Read/Write	R	R	R	R
Reset Value	n/a	n/a	n/a	n/a
Content	acc_z_msb<11:8>			
Bit	3	2	1	0
Read/Write	R	R	R	R
Reset Value	n/a	n/a	n/a	n/a
Content	acc_z_msb<7:4>			

acc_z_msb<11:4>: Most significant 8 bits of acceleration read-back value (two's-complement format)

ACC Register 0x08 (ACCD_TEMP)

The register contains the current chip temperature represented in two's complement format. A readout value of temp<7:0>=0x00 corresponds to a temperature of 23°C.

Name	0x08	ACCD_TEMP
------	------	-----------

Bit	7	6	5	4
Read/Write	R	R	R	R
Reset Value	n/a	n/a	n/a	n/a
Content	temp<7:4>			

Bit	3	2	1	0
Read/Write	R	R	R	R
Reset Value	n/a	n/a	n/a	n/a

Content temp<3:0>

temp<7:0>: Temperature value (two s-complement format)

ACC Register 0x09 (INT_STATUS_0)

The register contains interrupt status flags. Each flag is associated with a specific interrupt function. It is set when the associated interrupt triggers. The setting of latch_int<3:0> controls if the interrupt signal and hence the respective interrupt flag will be permanently latched, temporarily latched or not latched. The interrupt function associated with a specific status flag must be enabled.

Name	0x09	INT_STATUS_0		
Bit	7	6	5	4
Read/Write	R	R	R	R
Reset Value	n/a	n/a	n/a	n/a
Content	flat_int	orient_int	s_tap_int	d_tap_int
Bit	3	2	1	0
Read/Write	R	R	R	R
Reset Value	n/a	n/a	n/a	n/a
Content	slo_no_mot_int	slope_int	high_int	low_int

flat_int: flat interrupt status: '0'→inactive, '1' →active
 orient_int: orientation interrupt status: '0'→inactive, '1' →active
 s_tap_int: single tap interrupt status: '0'→inactive, '1' →active
 d_tap_int: double tap interrupt status: '0'→inactive, '1' →active
 slo_not_mot_int: slow/no-motion interrupt status: '0'→inactive, '1' →active
 slope_int: slope interrupt status: '0'→inactive, '1' →active
 high_int: high-g interrupt status: '0'→inactive, '1' →active
 low_int: low-g interrupt status: '0'→inactive, '1' →active

ACC Register 0x0A (INT_STATUS_1)

The register contains interrupt status flags. Each flag is associated with a specific interrupt function. It is set when the associated interrupt engine triggers. The setting of latch_int<3:0> controls if the interrupt signal and hence the respective interrupt flag will be permanently latched, temporarily latched or not latched. The interrupt function associated with a specific status flag must be enabled.

Name	0x0A	INT_STATUS_1		
Bit	7	6	5	4
Read/Write	R	R	R	R
Reset Value	n/a	n/a	n/a	n/a
Content	data_int	fifo_wm_int	fifo_full_int	reserved
Bit	3	2	1	0
Read/Write	R	R	R	R
Reset Value	n/a	n/a	n/a	n/a
Content	reserved			

data_int: data ready interrupt status: '0' → inactive, '1' → active
 fifo_wm_int: FIFO watermark interrupt status: '0' → inactive, '1' → active
 fifo_full_int: FIFO full interrupt status: '0' → inactive, '1' → active
 reserved: reserved, write to '0'

ACC Register 0x0B (INT_STATUS_2)

The register contains interrupt status flags. Each flag is associated with a specific interrupt engine. It is set when the associated interrupt engine triggers. The setting of latch_int<3:0> controls if the interrupt signal and hence the respective interrupt flag will be permanently latched, temporarily latched or not latched. The interrupt function associated with a specific status flag must be enabled.

Name	0x0B	INT_STATUS_2		
Bit	7	6	5	4
Read/Write	R	R	R	R
Reset Value	n/a	n/a	n/a	n/a
Content	tap_sign	tap_first_z	tap_first_y	tap_first_x
Bit	3	2	1	0
Read/Write	R	R	R	R
Reset Value	n/a	n/a	n/a	n/a
Content	slope_sign	slope_first_z	slope_first_y	slope_first_x

tap_sign:	sign of single/double tap triggering signal was '0'→positive, or '1' →negative
tap_first_z:	single/double tap interrupt: '1' → triggered by, or '0'→not triggered by z-axis
tap_first_y:	single/double tap interrupt: '1' → triggered by, or '0'→not triggered by y-axis
tap_first_x:	single/double tap interrupt: '1' → triggered by, or '0'→not triggered by x-axis
slope_sign:	slope sign of slope tap triggering signal was '0'→positive, or '1' →negative
slope_first_z:	slope interrupt: '1' → triggered by, or '0'→not triggered by z-axis
slope_first_y:	slope interrupt: '1' → triggered by, or '0'→not triggered by y-axis
slope_first_x:	slope interrupt: '1' → triggered by, or '0'→not triggered by x-axis

ACC Register 0x0C (INT_STATUS_3)

The register contains interrupt status flags. Each flag is associated with a specific interrupt engine. It is set when the associated interrupt engine triggers. With the exception of orient<3:0> the setting of latch_int<3:0> controls if the interrupt signal and hence the respective interrupt flag will be permanently latched, temporarily latched or not latched. The interrupt function associated with a specific status flag must be enabled.

Name	0x0C	INT_STATUS_3		
Bit	7	6	5	4
Read/Write	R	R	R	R
Reset Value	n/a	n/a	n/a	n/a
Content	flat	orient<2:0>		
Bit	3	2	1	0
Read/Write	R	R	R	R
Reset Value	n/a	n/a	n/a	n/a
Content	high_sign	high_first_z	high_first_y	high_first_x

flat:	device is in '1' → flat, or '0'→ non flat position; only valid if (ACC 0x16) flat_en = '1' ‘
orient<2>:	Orientation value of z-axis: '0' → upward looking, or '1' → downward looking. The flag always reflect the current orientation status, independent of the setting of latch_int<3:0>. The flag is not updated as long as an orientation blocking condition is active.
orient<1:0>:	orientation value of x-y-plane: '00'→portrait upright; '01'→portrait upside down; '10'→landscape left; '11'→landscape right; The flags always reflect the current orientation status, independent of the setting of latch_int<3:0>. The flag is not updated as long as an orientation blocking condition is active.
high_sign:	sign of acceleration signal that triggered high-g interrupt was '0'→positive, '1' →negative
high_first_z:	high-g interrupt: '1' → triggered by, or '0'→not triggered by z-axis
high_first_y:	high-g interrupt: '1' → triggered by, or '0'→not triggered by y-axis
high_first_x:	high-g interrupt: '1' → triggered by, or '0'→not triggered by x-axis

ACC Register 0x0D is reserved
ACC Register 0x0E (FIFO_STATUS)

The register contains FIFO status flags.

Name	0x0E	FIFO_STATUS		
Bit	7	6	5	4
Read/Write	R	R	R	R
Reset Value	n/a	n/a	n/a	n/a
Content	fifo_overrun	fifo_frame_counter<6:4>		
Bit	3	2	1	0
Read/Write	R	R	R	R
Reset Value	n/a	n/a	n/a	n/a
Content	fifo_frame_counter<3:0>			

fifo_overrun: FIFO overrun condition has '1' → occurred, or '0' → not occurred; flag can be cleared by writing to the FIFO configuration register FIFO_CONFIG_1 only

fifo_frame_counter<6:4>: Current fill level of FIFO buffer. An empty FIFO corresponds to 0x00. The frame counter can be cleared by reading out all frames from the FIFO buffer or writing to the FIFO configuration register FIFO_CONFIG_1.

ACC Register 0x0F (PMU_RANGE)

The register allows the selection of the accelerometer g-range.

Name	0x0F	PMU_RANGE		
Bit	7	6	5	4
Read/Write	R/W	R/W	R/W	R/W
Reset Value	0	0	0	0
Content	reserved			
Bit	3	2	1	0
Read/Write	R/W	R/W	R/W	R/W
Reset Value	0	0	1	1
Content	range<3:0>			

range<3:0>: Selection of accelerometer g-range:
 '0011b' → ±2g range; '0101b' → ±4g range; '1000b' → ±8g range;
 '1100b' → ±16g range; all other settings → reserved (do not use)

reserved: write '0'

ACC Register 0x10 (PMU_BW)

The register allows the selection of the acceleration data filter bandwidth.

Name	0x10	PMU_BW		
Bit	7	6	5	4
Read/Write	R/W	R/W	R/W	R/W
Reset Value	0	0	0	0
Content	reserved			bw<4>
Bit	3	2	1	0
Read/Write	R/W	R/W	R/W	R/W
Reset Value	1	1	1	1
Content	bw<3:0>			

bw<4:0>: Selection of data filter bandwidth:
 '00xxxb' → 7.81 Hz, '01000b' → 7.81 Hz, '01001b' → 15.63 Hz,
 '01010b' → 31.25 Hz, '01011b' → 62.5 Hz, '01100b' → 125 Hz,
 '01101b' → 250 Hz, '01110b' → 500 Hz, '01111b' → 1000 Hz,
 '1xxxxb' → 1000 Hz

reserved: write '0'

ACC Register 0x11 (PMU_LPW)

Selection of the main power modes and the low power sleep period.

Name	0x11	PMU_LPW		
Bit	7	6	5	4
Read/Write	R/W	R/W	R/W	R/W
Reset Value	0	0	0	0
Content	suspend	lowpower_en	deep_suspend	sleep_dur<3>
Bit	3	2	1	0
Read/Write	R/W	R/W	R/W	R/W
Reset Value	0	0	0	0
Content	sleep_dur<2:0>			reserved

suspend, low_power_en, deep_suspend:

Main power mode configuration setting {suspend; lowpower_en; deep_suspend}:

{0; 0; 0} → NORMAL mode;
 {0; 0; 1} → DEEP_SUSPEND mode;
 {0; 1; 0} → LOW_POWER mode;
 {1; 0; 0} → SUSPEND mode;
 {all other} → illegal

Please note that only certain power mode transitions are permitted.

sleep_dur<3:0>: Configures the sleep phase duration in LOW_POWER mode:

'0000b' to '0101b'	→ 0.5 ms,	'0110b' → 1 ms,
'0111b'	→ 2 ms,	'1000b' → 4 ms,
'1001b'	→ 6 ms,	'1010b' → 10 ms,
'1011b'	→ 25 ms,	'1100b' → 50 ms,
'1101b'	→ 100 ms,	'1110b' → 500 ms,
'1111b'	→ 1 s	

Please note, that all application specific settings which are not equal to the default settings (refer to 6.2 register map), must be re-set to its designated values after DEEP_SUSPEND.

ACC Register 0x12 (PMU_LOW_POWER)

Configuration settings for low power mode.

Name	0x12	PMU_LOW_POWER			
Bit	7	6	5	4	
Read/Write	R/W	R/W	R/W	R/W	
Reset Value	0	0	0	0	
Content	reserved	lowpower_mode	sleeptimer_mode	reserved	
Bit	3	2	1	0	
Read/Write	R/W	R/W	R/W	R/W	
Reset Value	0	0	0	0	
Content	reserved				

lowpower_mode: select '0' → LPM1, or '1' → LPM2 configuration for SUSPEND and LOW_POWER mode. In the LPM1 configuration the power consumption in LOW_POWER mode and SUSPEND mode is significantly reduced when compared to LPM2 configuration, but the FIFO is not accessible and writing to registers must be slowed down. In the LPM2 configuration the power consumption in LOW_POWER mode is reduced compared to NORMAL mode, but the FIFO is fully accessible and registers can be written to at full speed.

sleeptimer_mode: when in LOW_POWER mode '0' → use event-driven time-base mode (compatible with BMA250), or '1' → use equidistant sampling time-base mode. Equidistant sampling of data into the FIFO is maintained in equidistant time-base mode only.

reserved: write '0'

ACC Register 0x13 (ACCD_HBW)

Acceleration data acquisition and data output format.

Name	0x13	ACCD_HBW		
Bit	7	6	5	4
Read/Write	R/W	R/W	R/W	R/W
Reset Value	0	0 (1 in 8-bit mode)	0	0
Content	data_high_bw	shadow_dis	reserved	
Bit	3	2	1	0
Read/Write	R/W	R/W	R/W	R/W
Reset Value	0	0	0	0
Content	reserved			

data_high_bw: select whether '1' → unfiltered, or '0' → filtered data may be read from the acceleration data registers.

shadow_dis: '1' → disable, or '0' → the shadowing mechanism for the acceleration data output registers. When shadowing is enabled, the content of the acceleration data component in the MSB register is locked, when the component in the LSB is read, thereby ensuring the integrity of the acceleration data during read-out. The lock is removed when the MSB is read.

reserved: write '0'

ACC Register 0x14 (BGW_SOFTRESET)

Controls user triggered reset of the sensor.

Name	0x14	BGW_SOFTRESET		
Bit	7	6	5	4
Read/Write	W	W	W	W
Reset Value	0	0	0	0
Content	softreset			
Bit	3	2	1	0
Read/Write	W	W	W	W
Reset Value	0	0	0	0
Content	softreset			

softreset: 0xB6 → triggers a reset. Other values are ignored. Following a delay, all user configuration settings are overwritten with their default state or the setting stored in the NVM, wherever applicable. This register is functional in all operation modes. Please note that all application specific settings which are not equal to the default settings (refer to 6.2 register map), must be reconfigured to their designated values.

ACC Register 0x15 is reserved
ACC Register 0x16 (INT_EN_0)

Controls which interrupt engines in group 0 are enabled.

Name	0x16	INT_EN_0		
Bit	7	6	5	4
Read/Write	R/W	R/W	R/W	R/W
Reset Value	0	0	0	0
Content	flat_en	orient_en	s_tap_en	d_tap_en
Bit	3	2	1	0
Read/Write	R/W	R/W	R/W	R/W
Reset Value	0	0	0	0
Content	reserved	slope_en_z	slope_en_y	slope_en_x

flat_en: flat interrupt: '0'→disabled, or '1' →enabled
 orient_en: orientation interrupt: '0'→disabled, or '1' →enabled
 s_tap_en: single tap interrupt: '0'→disabled, or '1' →enabled
 d_tap_en: double tap interrupt: '0'→disabled, or '1' →enabled
 reserved: write '0'
 slope_en_z: slope interrupt, z-axis component: '0'→disabled, or '1' →enabled
 slope_en_y: slope interrupt, y-axis component: '0'→disabled, or '1' →enabled
 slope_en_x: slope interrupt, x-axis component: '0'→disabled, or '1' →enabled

ACC Register 0x17 (INT_EN_1)

Controls which interrupt engines in group 1 are enabled.

Name	0x17	INT_EN_1		
Bit	7	6	5	4
Read/Write	R/W	R/W	R/W	R/W
Reset Value	0	0	0	0
Content	reserved	int_fwm_en	int_full_en	data_en
Bit	3	2	1	0
Read/Write	R/W	R/W	R/W	R/W
Reset Value	0	0	0	0
Content	low_en	high_en_z	high_en_y	high_en_x

reserved: write '0'
 int_fwm_en: FIFO watermark interrupt: '0'→disabled, or '1' →enabled
 int_full_en: FIFO full interrupt: '0'→disabled, or '1' →enabled

data_en	data ready interrupt: '0'→disabled, or '1' →enabled
low_en:	low-g interrupt: '0'→disabled, or '1' →enabled
high_en_z:	high-g interrupt, z-axis component: '0'→disabled, or '1' →enabled
high_en_y:	high-g interrupt, y-axis component: '0'→disabled, or '1' →enabled
high_en_x:	high-g interrupt, x-axis component: '0'→disabled, or '1' →enabled

ACC Register 0x18 (INT_EN_2)

Controls which interrupt engines in group 2 are enabled.

Name	0x18	INT_EN_2		
Bit	7	6	5	4
Read/Write	R/W	R/W	R/W	R/W
Reset Value	0	0	0	0
Content	reserved			
Bit	3	2	1	0
Read/Write	R/W	R/W	R/W	R/W
Reset Value	0	0	0	0
Content	slo_no_mot_sel	slo_no_mot_en_z	slo_no_mot_en_y	slo_no_mot_en_x

reserved: write '0'

slo_no_mot_sel: select '0'→slow-motion, '1' →no-motion interrupt function

slo_no_mot_en_z: slow/n-motion interrupt, z-axis component: '0'→disabled, or '1' →enabled

slo_no_mot_en_y: slow/n-motion interrupt, y-axis component: '0'→disabled, or '1' →enabled

slo_no_mot_en_x: slow/n-motion interrupt, x-axis component: '0'→disabled, or '1' →enabled

ACC Register 0x19 (INT_MAP_0)

Controls which interrupt signals are mapped to the INT1 pin.

Name	0x19	INT_MAP_0		
Bit	7	6	5	4
Read/Write	R/W	R/W	R/W	R/W
Reset Value	0	0	0	0
Content	int1_flat	int1_orient	int1_s_tap	int1_d_tap
Bit	3	2	1	0
Read/Write	R/W	R/W	R/W	R/W
Reset Value	0	0	0	0
Content	int1_slo_no_mot	int1_slope	int1_high	int1_low

int1_flat:	map flat interrupt to INT1 pin: '0'→disabled, or '1' →enabled
int1_orient:	map orientation interrupt to INT1 pin: '0'→disabled, or '1' →enabled
int1_s_tap:	map single tap interrupt to INT1 pin: '0'→disabled, or '1' →enabled
int1_d_tap:	map double tap interrupt to INT1 pin: '0'→disabled, or '1' →enabled
int1_slo_no_mot:	map slow/no-motion interrupt to INT1 pin: '0'→disabled, or '1' →enabled
int1_slope:	map slope interrupt to INT1 pin: '0'→disabled, or '1' →enabled
int1_high:	map high-g to INT1 pin: '0'→disabled, or '1' →enabled
int1_low:	map low-g to INT1 pin: '0'→disabled, or '1' →enabled

ACC Register 0x1A (INT_MAP_1)

Controls which interrupt signals are mapped to the INT1 and INT2 pins.

Name	0x1A	INT_MAP_1		
Bit	7	6	5	4
Read/Write	R/W	R/W	R/W	R/W
Reset Value	0	0	0	0
Content	int2_data	int2_fwm	int2_full	reserved
Bit	3	2	1	0
Read/Write	R/W	R/W	R/W	R/W
Reset Value	0	0	0	0
Content	reserved	int1_full	int1_fwm	int1_data

int2_data:	map data ready interrupt to INT2 pin: '0'→disabled, or '1' →enabled
int2_fwm:	map FIFO watermark interrupt to INT2 pin: '0'→disabled, or '1' →enabled
int2_full:	map FIFO full interrupt to INT2 pin: '0'→disabled, or '1' →enabled
reserved:	write '0'
int1_full:	map FIFO full interrupt to INT1 pin: '0'→disabled, or '1' →enabled
int1_fwm:	map FIFO watermark interrupt to INT1 pin: '0'→disabled, or '1' →enabled
int1_data:	map data ready interrupt to INT1 pin: '0'→disabled, or '1' →enabled

ACC Register 0x1B (INT_MAP_2)

Controls which interrupt signals are mapped to the INT2 pin.

Name	0x1B	INT_MAP_2		
Bit	7	6	5	4
Read/Write	R/W	R/W	R/W	R/W
Reset Value	0	0	0	0
Content	int2_flat	int2_orient	int2_s_tap	int2_d_tap
Bit	3	2	1	0
Read/Write	R/W	R/W	R/W	R/W
Reset Value	0	0	0	0
Content	int2_slo_no_mot	int2_slope	int2_high	int2_low

int2_flat:	map flat interrupt to INT2 pin: '0'→disabled, or '1' →enabled
int2_orient:	map orientation interrupt to INT2 pin: '0'→disabled, or '1' →enabled
int2_s_tap:	map single tap interrupt to INT2 pin: '0'→disabled, or '1' →enabled
int2_d_tap:	map double tap interrupt to INT2 pin: '0'→disabled, or '1' →enabled
int2_slo_no_mot:	map slow/no-motion interrupt to INT2 pin: '0'→disabled, or '1' →enabled
int2_slope:	map slope interrupt to INT2 pin: '0'→disabled, or '1' →enabled
int2_high:	map high-g to INT2 pin: '0'→disabled, or '1' →enabled
int2_low:	map low-g to INT2 pin: '0'→disabled, or '1' →enabled

ACC Register 0x1C is reserved

ACC Register 0x1D is reserved

ACC Register 0x1E (INT_SRC)

Contains the data source definition for interrupts with selectable data source.

Name	0x1E	INT_SRC		
Bit	7	6	5	4
Read/Write	R/W	R/W	R/W	R/W
Reset Value	0	0	0	0
Content	reserved		int_src_data	int_src_tap
Bit	3	2	1	0
Read/Write	R/W	R/W	R/W	R/W
Reset Value	0	0	0	0
Content	int_src_slo_no_m	int_src_slope	int_src_high	int_src_low

	ot
reserved:	write '0'
int_src_data:	select '0'→filtered, or '1' →unfiltered data for new data interrupt
int_src_tap:	select '0'→filtered, or '1' →unfiltered data for single-/double tap interrupt
int_src_slo_no_mot:	select '0'→filtered, or '1' →unfiltered data for slow/no-motion interrupt
int_src_slope:	select '0'→filtered, or '1' →unfiltered data for slope interrupt
int_src_high:	select '0'→filtered, or '1' →unfiltered data for high-g interrupt
int_src_low:	select '0'→filtered, or '1' →unfiltered data for low-g interrupt

ACC Register 0x1F is reserved

ACC Register 0x20 (INT_OUT_CTRL)

Contains the behavioural configuration (electrical behavior) of the interrupt pins.

Name	0x20	INT_OUT_CTRL		
Bit	7	6	5	4
Read/Write	R/W	R/W	R/W	R/W
Reset Value	0	0	0	0
Content	reserved			
Bit	3	2	1	0
Read/Write	R/W	R/W	R/W	R/W
Reset Value	0	1	0	1
Content	int2_od	int2_lvl	int1_od	int1_lvl

reserved:	write '0'
int2_od:	select '0'→push-pull, or '1' →open drain behavior for INT2 pin
int2_lvl:	select '0'→active low, or '1'→active high level for INT2 pin
int1_od:	select '0'→push-pull, or '1' →open drain behavior for INT1 pin
int1_lvl:	select '0'→active low, or '1'→active high level for INT1 pin

ACC Register 0x21 (INT_RST_LATCH)

Contains the interrupt reset bit and the interrupt mode selection.

Name	0x21	INT_RST_LATCH		
Bit	7	6	5	4
Read/Write	W	R/W	R/W	R/W
Reset Value	0	0	0	0
Content	reset_int	Reserved		

Bit	3	2	1	0
Read/Write	R/W	R/W	R/W	R/W
Reset Value	0	0	0	0
Content	latch_int<3:0>			

reset_int: write '1' → clear any latched interrupts, or '0' → keep latched interrupts active

reserved: write '0'

latch_int<3:0>: '0000b' → non-latched, '0001b' → temporary, 250 ms,
 '0010b' → temporary, 500 ms, '0011b' → temporary, 1 s,
 '0100b' → temporary, 2 s, '0101b' → temporary, 4 s,
 '0110b' → temporary, 8 s, '0111b' → latched,
 '1000b' → non-latched, '1001b' → temporary, 250 μs,
 '1010b' → temporary, 500 μs, '1011b' → temporary, 1 ms,
 '1100b' → temporary, 12.5 ms, '1101b' → temporary, 25 ms,
 '1110b' → temporary, 50 ms, '1111b' → latched

ACC Register 0x22 (INT_0)

Contains the delay time definition for the low-g interrupt.

Name	0x22	INT_0		
Bit	7	6	5	4
Read/Write	W	R/W	R/W	R/W
Reset Value	0	0	0	0
Content	low_dur<7:4>			
Bit	3	2	1	0
Read/Write	R/W	R/W	R/W	R/W
Reset Value	1	0	0	1
Content	low_dur<3:0>			

low_dur<7:0>: low-g interrupt trigger delay according to $[low_dur<7:0> + 1] \cdot 2$ ms in a range from 2 ms to 512 ms; the default corresponds to a delay of 20 ms.

ACC Register 0x23 (INT_1)

Contains the threshold definition for the low-g interrupt.

Name	0x23	INT_1		
Bit	7	6	5	4
Read/Write	W	R/W	R/W	R/W
Reset Value	0	0	1	1
Content	low_th<7:4>			

Bit	3	2	1	0
Read/Write	R/W	R/W	R/W	R/W
Reset Value	0	0	0	0
Content	low_th<3:0>			

low_th<7:0>: low-g interrupt trigger threshold according to low_th<7:0> • 7.81 mg in a range from 0 g to 1.992 g; the default value corresponds to an acceleration of 375 mg

ACC Register 0x24 (INT_2)

Contains the low-g interrupt mode selection, the low-g interrupt hysteresis setting, and the high-g interrupt hysteresis setting.

Name	0x24	INT_2		
Bit	7	6	5	4
Read/Write	R/W	R/W	R/W	R/W
Reset Value	1	0	0	0
Content	high_hy<1:0>		reserved	

Bit	3	2	1	0
Read/Write	R/W	R/W	R/W	R/W
Reset Value	0	0	0	1
Content	reserved	low_mode	low_hy<1:0>	

high_hy<1:0>: hysteresis of high-g interrupt according to high_hy<1:0> • 125 mg (2-g range), high_hy<1:0> • 250 mg (4-g range), high_hy<1:0> • 500 mg (8-g range), or high_hy<1:0> • 1000 mg (16-g range)

low_mode: select low-g interrupt '0' single-axis mode, or '1' axis-summing mode

low_hy<1:0>: hysteresis of low-g interrupt according to low_hy<1:0> • 125 mg independent of the selected accelerometer g-range

ACC Register 0x25 (INT_3)

Contains the delay time definition for the high-g interrupt.

Name	0x25	INT_3		
Bit	7	6	5	4
Read/Write	R/W	R/W	R/W	R/W
Reset Value	0	0	0	0
Content	high_dur<7:4>			

Bit	3	2	1	0
Read/Write	R/W	R/W	R/W	R/W
Reset Value	1	1	1	1
Content	high_dur<3:0>			

high_dur<7:0>: high-g interrupt trigger delay according to $[high_dur<7:0> + 1] \cdot 2$ ms in a range from 2 ms to 512 ms; the default corresponds to a delay of 32 ms.

ACC Register 0x26 (INT_4)

Contains the threshold definition for the high-g interrupt.

Name	0x26	INT_4		
Bit	7	6	5	4
Read/Write	R/W	R/W	R/W	R/W
Reset Value	1	1	0	0
Content	high_th<7:4>			
Bit	3	2	1	0
Read/Write	R/W	R/W	R/W	R/W
Reset Value	0	0	0	0
Content	high_th<3:0>			

high_th<7:0>: threshold of high-g interrupt according to $high_th<7:0> \cdot 7.81$ mg (2-g range), $high_th<7:0> \cdot 15.63$ mg (4-g range), $high_th<7:0> \cdot 31.25$ mg (8-g range), or $high_th<7:0> \cdot 62.5$ mg (16-g range)

ACC Register 0x27 (INT_5)

Contains the definition of the number of samples to be evaluated for the slope interrupt (any-motion detection) and the slow/no-motion interrupt trigger delay.

Name	0x27	INT_5		
Bit	7	6	5	4
Read/Write	R/W	R/W	R/W	R/W
Reset Value	0	0	0	0
Content	slo_no_mot_dur<5:2>			
Bit	3	2	1	0
Read/Write	R/W	R/W	R/W	R/W
Reset Value	0	0	0	0
Content	slo_no_mot_dur<1:0>		slope_dur<1:0>	

slo_no_mot_dur<5:0>: Function depends on whether the slow-motion or no-motion interrupt function has been selected. If the slow-motion interrupt function has been enabled (slo_no_mot_sel = '0') then [slo_no_mot_dur<1:0>+1] consecutive slope data points must be above the slow/no-motion threshold (slo_no_mot_th) for the slow-/no-motion interrupt to trigger. If the no-motion interrupt function has been enabled (slo_no_mot_sel = '1') then slo_no_motion_dur<5:0> defines the time for which no slope data points must exceed the slow/no-motion threshold (slo_no_mot_th) for the slow/no-motion interrupt to trigger. The delay time in seconds may be calculated according with the following equation:

$$\begin{aligned} \text{slo_no_mot_dur}\langle 5:4 \rangle = 'b00' &\rightarrow [\text{slo_no_mot_dur}\langle 3:0 \rangle + 1] \\ \text{slo_no_mot_dur}\langle 5:4 \rangle = 'b01' &\rightarrow [\text{slo_no_mot_dur}\langle 3:0 \rangle \cdot 4 + 20] \\ \text{slo_no_mot_dur}\langle 5 \rangle = '1' &\rightarrow [\text{slo_no_mot_dur}\langle 4:0 \rangle \cdot 8 + 88] \end{aligned}$$

slope_dur<1:0>: slope interrupt triggers if [slope_dur<1:0>+1] consecutive slope data points are above the slope interrupt threshold slope_th<7:0>

ACC Register 0x28 (INT_6)

Contains the threshold definition for the any-motion interrupt.

Name	0x28	INT_6		
Bit	7	6	5	4
Read/Write	R/W	R/W	R/W	R/W
Reset Value	0	0	0	1
Content	slope_th<7:4>			
Bit	3	2	1	0
Read/Write	R/W	R/W	R/W	R/W
Reset Value	0	1	0	0
Content	slope_th<3:0>			

slope_th<7:0>: Threshold of the any-motion interrupt. It is range-dependent and defined as a sample-to-sample difference according to
 slope_th<7:0> · 3.91 mg (2-g range) /
 slope_th<7:0> · 7.81 mg (4-g range) /
 slope_th<7:0> · 15.63 mg (8-g range) /
 slope_th<7:0> · 31.25 mg (16-g range)

ACC Register 0x29 (INT_7)

Contains the threshold definition for the slow/no-motion interrupt.

Name	0x29	INT_7		
Bit	7	6	5	4
Read/Write	R/W	R/W	R/W	R/W
Reset Value	0	0	0	1
Content	slo_no_mot_th<7:4>			
Bit	3	2	1	0
Read/Write	R/W	R/W	R/W	R/W
Reset Value	0	1	0	0
Content	slo_no_mot_th<3:0>			

slo_no_mot_th<7:0>: Threshold of slow/no-motion interrupt. It is range-dependent and defined as a sample-to-sample difference according to
 slo_no_mot_th<7:0> · 3.91 mg (2-g range),
 slo_no_mot_th<7:0> · 7.81 mg (4-g range),
 slo_no_mot_th<7:0> · 15.63 mg (8-g range),
 slo_no_mot_th<7:0> · 31.25 mg (16-g range)

ACC Register 0x2A (INT_8)

Contains the timing definitions for the single tap and double tap interrupts.

Name	0x2A	INT_8		
Bit	7	6	5	4
Read/Write	R/W	R/W	R/W	R/W
Reset Value	0	0	0	0
Content	tap_quiet	tap_shock	reserved	reserved
Bit	3	2	1	0
Read/Write	R/W	R/W	R/W	R/W
Reset Value	0	1	0	0
Content	reserved	tap_dur<2:0>		

tap_quiet: selects a tap quiet duration of '0' → 30 ms, '1' → 20 ms
 tap_shock: selects a tap shock duration of '0' → 50 ms, '1' → 75 ms
 reserved: write '0'
 tap_dur<2:0>: selects the length of the time window for the second shock event for double tap detection according to '000b' → 50 ms, '001b' → 100 ms, '010b' → 150 ms, '011b' → 200 ms, '100b' → 250 ms, '101b' → 375 ms, '110b' → 500 ms, '111b' → 700 ms.

ACC Register 0x2B (INT_9)

Contains the definition of the number of samples processed by the single / double-tap interrupt engine after wake-up in low-power mode. It also defines the threshold definition for the single and double tap interrupts.

Name	0x2B	INT_9		
Bit	7	6	5	4
Read/Write	R/W	R/W	R/W	R/W
Reset Value	0	0	0	0
Content	tap_samp<1:0>	reserved		tap_th<4>
Bit	3	2	1	0
Read/Write	R/W	R/W	R/W	R/W
Reset Value	1	0	1	0
Content	tap_th<3:0>			

tap_samp<1:0>: selects the number of samples that are processed after wake-up in the low-power mode according to '00b' → 2 samples, '01b' → 4 samples, '10b' → 8 samples, and '11b' → 16 samples

reserved: write '0'

tap_th<4>: threshold of the single/double-tap interrupt corresponding to an acceleration difference of tap_th<3:0> · 62.5mg (2g-range), tap_th<3:0> · 125mg (4g-range), tap_th<3:0> · 250mg (8g-range), and tap_th<3:0> · 500mg (16g-range).

ACC Register 0x2C (INT_A)

Contains the definition of hysteresis, blocking, and mode for the orientation interrupt

Name	0x2C	INT_A		
Bit	7	6	5	4
Read/Write	R/W	R/W	R/W	R/W
Reset Value	0	0	0	1
Content	reserved	orient_hyst<2:0>		
Bit	3	2	1	0
Read/Write	R/W	R/W	R/W	R/W
Reset Value	1	0	0	0
Content	orient_blocking<1:0>		orient_mode<1:0>	

- reserved: write '0'
- orient_hyst<2:0>: sets the hysteresis of the orientation interrupt; 1 LSB corresponds to 62.5 mg irrespective of the selected g-range
- orient_blocking<1:0>: selects the blocking mode that is used for the generation of the orientation interrupt. The following blocking modes are available:
 '00b' → no blocking,
 '01b' → theta blocking or acceleration in any axis > 1.5g,
 '10b' → ,theta blocking or acceleration slope in any axis > 0.2 g or acceleration in any axis > 1.5g
 '11b' → theta blocking or acceleration slope in any axis > 0.4 g or acceleration in any axis > 1.5g and value of orient is not stable for at least 100ms
- orient_mode<1:0>: sets the thresholds for switching between the different orientations. The settings: '00b' → symmetrical, '01b' → high-asymmetrical, '10b' → low-asymmetrical, '11b' → symmetrical.

ACC Register 0x2D (INT_B)

Contains the definition of the axis orientation, up/down masking, and the theta blocking angle for the orientation interrupt.

Name	0x2D	INT_B		
Bit	7	6	5	4
Read/Write	R/W	R/W	R/W	R/W
Reset Value	n/a	1	0	0
Content	reserved	orient_ud_en	orient_theta<5:4>	
Bit	3	2	1	0
Read/Write	R/W	R/W	R/W	R/W
Reset Value	1	0	0	0
Content	orient_theta<3:0>			

- orient_ud_en: change of up/down-bit '1' → generates an orientation interrupt, '0' → is ignored and will not generate an orientation interrupt
- orient_theta<5:0>: defines a blocking angle between 0° and 44.8°

ACC Register 0x2E (INT_C)

Contains the definition of the flat threshold angle for the flat interrupt.

Name	0x2E	INT_C		
Bit	7	6	5	4
Read/Write	R/W	R/W	R/W	R/W
Reset Value	n/a	n/a	0	0
Content	reserved	flat_theta<5:4>		

Bit	3	2	1	0
Read/Write	R/W	R/W	R/W	R/W
Reset Value	1	0	0	0
Content	flat_theta<3:0>			

reserved: write '0'

flat_theta<5:0>: defines threshold for detection of flat position in range from 0° to 44.8°.

ACC Register 0x2F (INT_D)

Contains the definition of the flat interrupt hold time and flat interrupt hysteresis.

Name	0x2F	INT_D		
Bit	7	6	5	4
Read/Write	R/W	R/W	R/W	R/W
Reset Value	0	0	0	1
Content	reserved	flat_hold_time<1:0>		
Bit	3	2	1	0
Read/Write	R/W	R/W	R/W	R/W
Reset Value	0	0	0	1
Content	reserved	flat_hy<2:0>		

reserved: write '0'

flat_hold_time<1:0>: delay time for which the flat value must remain stable for the flat interrupt to be generated: '00b' → 0 ms, '01b' → 512 ms, '10b' → 1024 ms, '11b' → 2048 ms

flat_hy<2:0>: defines flat interrupt hysteresis; flat value must change by more than twice the value of flat interrupt hysteresis to detect a state change. For details see chapter 4.7.8.

'000b' → hysteresis of the flat detection disabled

ACC Register 0x30 (FIFO_CONFIG_0)

Contains the FIFO watermark level.

Name	0x30	FIFO_CONFIG_0		
Bit	7	6	5	4
Read/Write	R/W	R/W	R/W	R/W
Reset Value	n/a	n/a	0	0
Content	reserved	fifo_water_mark_level_trigger_retain<5:4>		

Bit	3	2	1	0
Read/Write	R/W	R/W	R/W	R/W
Reset Value	0	0	0	0
Content	fifo_water_mark_level_trigger_retain<3:0>			

reserved: write '0'

fifo_water_mark_level_trigger_retain<5:0>: fifo_water_mark_level_trigger_retain<5:0> defines the FIFO watermark level. An interrupt will be generated, when the number of entries in the FIFO is equal to fifo_water_mark_level_trigger_retain<5:0>;

ACC Register 0x31 is reserved

ACC Register 0x32 (PMU_SELF_TEST)

Contains the settings for the sensor self-test configuration and trigger.

Name	0x32	PMU_SELF_TEST		
Bit	7	6	5	4
Read/Write	R/W	R/W	R/W	R/W
Reset Value	0	0	0	0
Content	reserved			self_test_amp

Bit	3	2	1	0
Read/Write	R/W	R/W	R/W	R/W
Reset Value	0	0	0	0
Content	reserved_0	self_test_sign	self_test-axis<1:0>	

reserved: write '0x0'

reserved_0: write '0x0'

self_test_amp; select amplitude of the selftest deflection '1' → high, default value is low ('0'),

self_test_sign: select sign of self-test excitation as '1' → positive, or '0' → negative

self_test_axis: select axis to be self-tested: '00b' → self-test disabled, '01b' → x-axis, '10b' → y-axis, or '11b' → z-axis; when a self-test is performed, only the acceleration data readout value of the selected axis is valid; after the self-test has been enabled a delay of a least 50 ms is necessary for the read-out value to settle

ACC Register 0x33 (TRIM_NVM_CTRL)

Contains the control settings for the few-time programmable non-volatile memory (NVM).

Name	0x33	TRIM_NVM_CTRL		
Bit	7	6	5	4
Read/Write	R	R	R	R
Reset Value	n/a	n/a	n/a	n/a
Content	nvm_remain<3:0>			
Bit	3	2	1	0
Read/Write	R/W	R	W	R/W
Reset Value	0	n/a	0	0
Content	nvm_load	nvm_rdy	nvm_prog_trig	nvm_prog_mode

nvm_remain<3:0>: number of remaining write cycles permitted for NVM; the number is decremented each time a write to the NVM is triggered

nvm_load: '1' → trigger, or '0' → do not trigger an update of all configuration registers from NVM; the nvm_rdy flag must be '1' prior to triggering the update

nvm_rdy: status of NVM controller: '0' → NVM write / NVM update operation is in progress, '1' → NVM is ready to accept a new write or update trigger

nvm_prog_trig: '1' → trigger, or '0' → do not trigger an NVM write operation; the trigger is only accepted if the NVM was unlocked before and nvm_remain<3:0> is greater than '0'; flag nvm_rdy must be '1' prior to triggering the write cycle

nvm_prog_mode: '1' → unlock, or '0' → lock NVM write operation

ACC Register 0x34 (BGW_SPI3_WDT)

Contains settings for the digital interfaces.

Name	0x34	BGW_SPI3_WDT		
Bit	7	6	5	4
Read/Write	R/W	R/W	R/W	R/W
Reset Value	0	0	0	0
Content	reserved			
Bit	3	2	1	0
Read/Write	R/W	R/W	R/W	R/W
Reset Value	0	0	0	0
Content	reserved	i2c_wdt_en	i2c_wdt_sel	spi3

reserved: write '0'

i2c_wdt_en: if I²C interface mode is selected then '1' → enable, or '0' → disables the watchdog at the SDI pin (= SDA for I²C)

i2c_wdt_sel: select an I²C watchdog timer period of '0' → 1 ms, or '1' → 50 ms

spi3: select '0' → 4-wire SPI, or '1' → 3-wire SPI mode

ACC Register 0x35 is reserved

ACC Register 0x36 (OFC_CTRL)

Contains control signals and configuration settings for the fast and the slow offset compensation.

Name	0x36	OFC_CTRL		
Bit	7	6	5	4
Read/Write	W	W	W	R
Reset Value	0	0	0	0
Content	offset_reset	cal_trigger<1:0>		cal_rdy
Bit	3	2	1	0
Read/Write	R/W	R/W	R/W	R/W
Reset Value	0	0	0	0
Content	reserved	hp_z_en	hp_y_en	hp_x_en

offset_reset: '1' → set all offset compensation registers (0x38 to 0x3A) to zero, or '0' → keep their values

offset_trigger<1:0>: trigger fast compensation for '01b' → x-axis, '10b' → y-axis, or '11b' → z-axis; '00b' → do not trigger offset compensation; offset compensation must not be triggered when cal_rdy is '0'

cal_rdy: indicates the state of the fast compensation: '0' → offset compensation is in progress, or '1' → offset compensation is ready to be retrIGGERED

reserved: write '0'

hp_z_en: '1' → enable, or '0' → disable slow offset compensation for the z-axis

hp_y_en: '1' → enable, or '0' → disable slow offset compensation for the y-axis

hp_x_en: '1' → enable, or '0' → disable slow offset compensation for the x-axis

ACC Register 0x37 (OFC_SETTING)

Contains configuration settings for the fast and the slow offset compensation.

Name	0x37	OFC_SETTING		
Bit	7	6	5	4
Read/Write	R/W	R/W	R/W	R/W
Reset Value	0	0	0	0
Content	reserved	offset_target_z<1:0>		offset_target_y<1>
Bit	3	2	1	0
Read/Write	R/W	R/W	R/W	R/W
Reset Value	0	0	0	0
Content	offset_target_y<0>	offset_target_x<1:0>		cut_off

reserved: write '0'

offset_target_z<1:0>: offset compensation target value for z-axis is '00b' → 0 g, '01b' → +1 g, '10b' → -1 g, or '11b' → 0 g

offset_target_y<1:0>: offset compensation target value for y-axis is '00b' → 0 g, '01b' → +1 g, '10b' → -1 g, or '11b' → 0 g

offset_target_x<1:0>: offset compensation target value for x-axis is '00b' → 0 g, '01b' → +1 g, '10b' → -1 g, or '11b' → 0 g

cut_off: select '0' → 1 Hz, or '1' → 10 Hz cut-off frequency for slow offset compensation high-pass filter

ACC Register 0x38 (OFC_OFFSET_X)

Contains the offset compensation value for x-axis acceleration readout data.

Name	0x38	OFC_OFFSET_X		
Bit	7	6	5	4
Read/Write	R/W	R/W	R/W	R/W
Reset Value	0	0	0	0
Content	offset_x<7:4>			
Bit	3	2	1	0
Read/Write	R/W	R/W	R/W	R/W
Reset Value	0	0	0	0
Content	offset_x<3:0>			

offset_x<7:0>: offset value, which is added to the internal filtered and unfiltered x-axis acceleration data; the offset value is represented with two's complement notation, with a mapping of +127 → +0.992g, 0 → 0 g, and -128 → -1 g; the scaling is independent of the selected g-range; the content of the offset_x<7:0> may be written to the NVM; it is automatically restored from the NVM after each power-on or softreset; offset_x<7:0> may be written directly by the user; it is generated automatically after triggering the fast offset compensation procedure for the x-axis

Example:

Original readout value	Value in offset register	Compensated readout value
0 g	127	0.992 g
0 g	0	0 g
0 g	-128	-1 g

ACC Register 0x39 (OFC_OFFSET_Y)

Contains the offset compensation value for y-axis acceleration readout data.

Name	0x39	OFC_OFFSET_Y		
Bit	7	6	5	4
Read/Write	R/W	R/W	R/W	R/W
Reset Value	0	0	0	0
Content	offset_y<7:4>			
Bit	3	2	1	0
Read/Write	R/W	R/W	R/W	R/W
Reset Value	0	0	0	0
Content	offset_y<3:0>			

offset_y<7:0>: offset value, which is added to the internal filtered and unfiltered y-axis acceleration data; the offset value is represented with two's complement notation, with a mapping of +127 → +0.992g, 0 → 0 g, and -128 → -1 g; the scaling is independent of the selected g-range; the content of the offset_y<7:0> may be written to the NVM; it is automatically restored from the NVM after each power-on or softreset; offset_y<7:0> may be written directly by the user; it is generated automatically after triggering the fast offset compensation procedure for the y-axis

For reference see example at ACC Register 0x38 (OFC_OFFSET_X)

ACC Register 0x3A (OFC_OFFSET_Z)

Contains the offset compensation value for z-axis acceleration readout data.

Name	0x3A	OFC_OFFSET_Z		
Bit	7	6	5	4
Read/Write	R/W	R/W	R/W	R/W
Reset Value	0	0	0	0
Content	offset_z<7:4>			

Bit	3	2	1	0
Read/Write	R/W	R/W	R/W	R/W
Reset Value	0	0	0	0
Content	offset_z<3:0>			

offset_z<7:0>: offset value, which is added to the internal filtered and unfiltered z-axis acceleration data; the offset value is represented with two's complement notation, with a mapping of +127 → +0.992g, 0 → 0 g, and -128 → -1 g; the scaling is independent of the selected g-range; the content of the offset_z<7:0> may be written to the NVM; it is automatically restored from the NVM after each power-on or softreset; offset_z<7:0> may be written directly by the user; it is generated automatically after triggering the fast offset compensation procedure for the z-axis

For reference see example at ACC Register 0x38 (OFC_OFFSET_X)

ACC Register 0x3B (TRIM_GP0)

Contains general purpose data register with NVM back-up.

Name	0x3B	TRIM_GP0		
Bit	7	6	5	4
Read/Write	R/W	R/W	R/W	R/W
Reset Value	0	0	0	0
Content	GP0<7:4>			

Bit	3	2	1	0
Read/Write	R/W	R/W	R/W	R/W
Reset Value	0	0	0	0
Content	GP0<3:0>			

GP0<7:0>: general purpose NVM image register not linked to any sensor-specific functionality; register may be written to NVM and is restored after each power-up or softreset

ACC Register 0x3C (TRIM_GP1)

Contains general purpose data register with NVM back-up.

Name	0x3C	TRIM_GP1		
Bit	7	6	5	4
Read/Write	R/W	R/W	R/W	R/W
Reset Value	0	0	0	0
Content	GP1<7:4>			
Bit	3	2	1	0
Read/Write	R/W	R/W	R/W	R/W
Reset Value	0	0	0	0
Content	GP1<3:0>			

GP1<7:0>: general purpose NVM image register not linked to any sensor-specific functionality; register may be written to NVM and is restored after each power-up or softreset

ACC Register 0x3D is reserved

ACC Register 0x3E (FIFO_CONFIG_1)

Contains FIFO configuration settings. The FIFO buffer memory is cleared and the fifo-full flag is cleared when writing to FIFO_CONFIG_1 register.

Name	0x3E	FIFO_CONFIG_1		
Bit	7	6	5	4
Read/Write	R/W	R/W	R/W	R/W
Reset Value	0	0	0	0
Content	fifo_mode<1:0>		Reserved	
Bit	3	2	1	0
Read/Write	R/W	R/W	R/W	R/W
Reset Value	0	0	0	0
Content	Reserved		fifo_data_select<1:0>	

fifo_mode<1:0>: selects the FIFO operating mode:
 '00b' → BYPASS (buffer depth of 1 frame; old data is discarded),
 '01b' → FIFO (data collection stops when buffer is filled with 32 frames),
 '10b' → STREAM (sampling continues when buffer is full; old is discarded),
 '11b' → reserved, do not use

fifo_data_select<1:0>: selects whether '00b' → X+Y+Z, '01b' → X only, '10b' → Y only, '11b' → Z only acceleration data are stored in the FIFO

ACC Register 0x3F (FIFO_DATA)

FIFO data readout register. The format of the LSB and MSB components corresponds to that of the acceleration data readout registers. The new data flag is preserved. Read burst access may be used since the address counter will not increment when the read burst is started at the address of FIFO_DATA. The entire frame is discarded when a frame is only partially read out.

Name	0x3F	FIFO_DATA		
Bit	7	6	5	4
Read/Write	R	R	R	R
Reset Value	n/a	n/a	n/a	n/a
Content	fifo_data_output_register<7:4>			
Bit	3	2	1	0
Read/Write	R	R	R	R
Reset Value	n/a	n/a	n/a	n/a
Content	fifo_data_output_register<3:0>			

fifo_data_output_register<7:0>: FIFO data readout; data format depends on the setting of register fifo_data_select<1:0>:
 if X+Y+Z data are selected, the data of frame n is reading out in the order of X-lsb(n), X-msb(n), Y-lsb(n), Y-msb(n), Z-lsb(n), Z-msb(n);
 if X-only is selected, the data of frame n and n+1 are reading out in the order of X-lsb(n), X-msb(n), X-lsb(n+1), X-msb(n+1); the Y-only and Z-only modes behave analogously

7. Functional description Gyro

Note: Default values for registers can be found in chapter 8.

7.1 Power modes gyroscope

The gyroscope has 4 different power modes. Besides normal mode, which represents the fully operational state of the device, there are 3 energy saving modes: deep-suspend mode, suspend mode, and fast power up

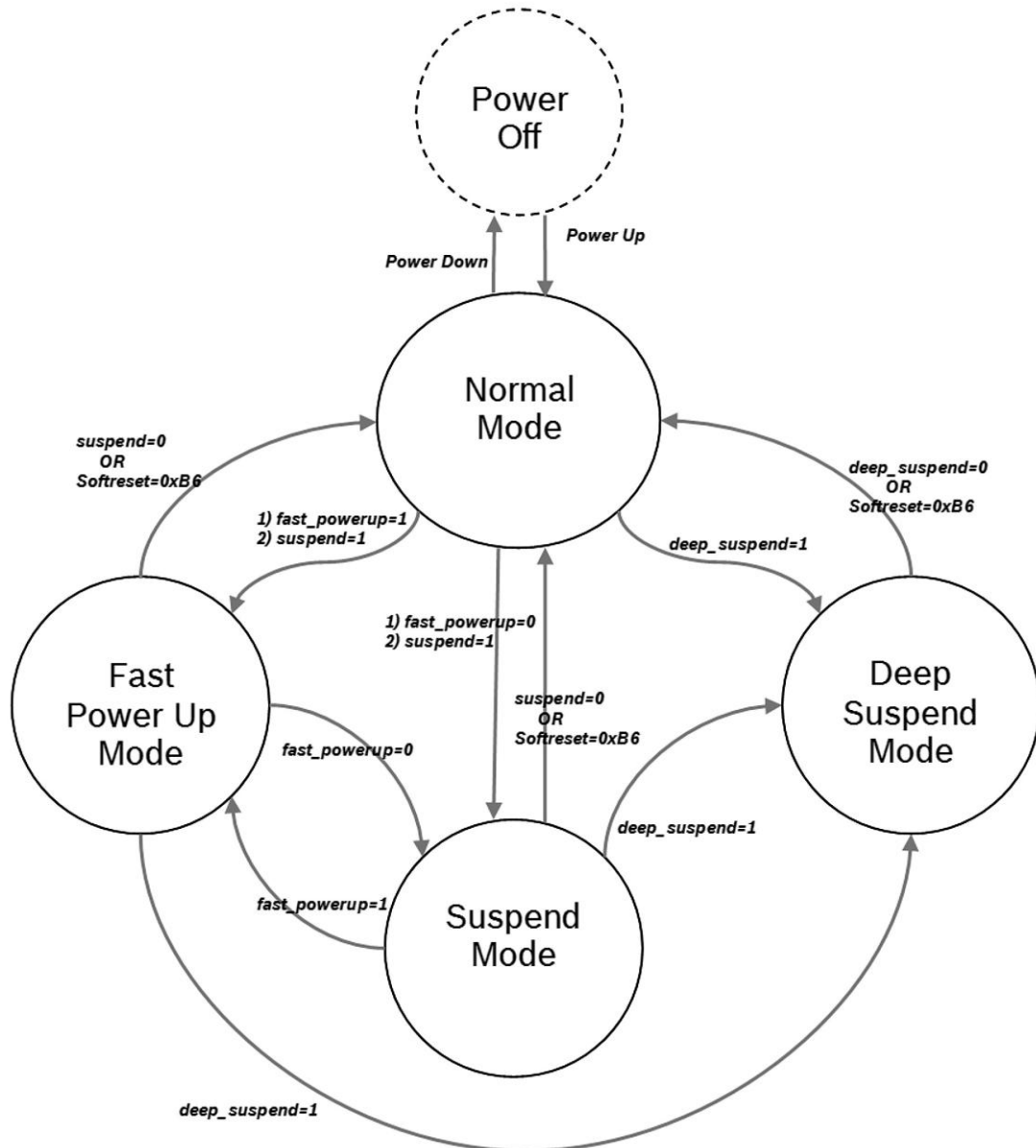

Figure 13: Block diagram of the power modes of gyroscope

After power-up gyro is in normal mode so that all parts of the device are held powered-up and data acquisition is performed continuously.

In **deep-suspend mode** the device reaches the lowest possible power consumption. Only the interface section is kept alive. No data acquisition is performed and the content of the configuration registers is lost. Deep suspend mode is entered (left) by writing '1' ('0') to the (GYR 0x11) *deep_suspend* bit. The I²C watchdog timer remains functional. The (GYR 0x11) *deep_suspend* bit, the (GYR 0x34) *spi3* bit, (GYR 0x34) *i2c_wdt_en* bit and the (GYR 0x34) *i2c_wdt_sel* bit are functional in deep-suspend mode. Equally the interrupt level and driver configuration registers (GYR 0x20) *int1_lvl*, (GYR 0x20) *int1_od*, (GYR 0x20) *int2_lvl*, and (GYR 0x20) *int2_od* are accessible. Still it is possible to enter normal mode by writing to the (GYR 0x14) *softreset* register. Please note, that all application specific settings which are not equal to the default settings (refer to 8.2 register map gyroscope), must be re-set to its designated values after leaving deep-suspend mode.

In **suspend mode** the whole analog part is powered down. No data acquisition is performed. While in suspend mode the latest rate data and the content of all configuration registers are kept. The only supported operations are reading registers as well as writing to the (GYR 0x14) *softreset* register.

Suspend mode is entered (left) by writing '1' ('0') to the (GYR 0x11) *suspend* bit. Bit (GYR 0x12) *fast_power_up* must be set to '0'.

Although write access to registers is supported at the full interface clock speed (SCL or SCK), a waiting period must be inserted between two consecutive write cycles (please refer also to section 9.2.1).

In **external wake-up mode**, when the device is in deep suspend mode or suspend mode, it can be woken-up by external trigger to pin INT3/4. Register settings:

Table 22

ext_trig_sel [1:0]	Trigger source
'00'	No
'01'	INT3 pin
'10'	INT4 pin
'11'	SDO2 pin (SPI3 mode)

In **fast power-up mode** the sensing analog part is powered down, while the drive and the digital part remains largely operational. No data acquisition is performed. Reading and writing registers as well as writing to the (GYR 0x14) *softreset* register are supported without any restrictions. The latest rate data and the content of all configuration registers are kept. Fast power-up mode is entered (left) by writing '1' ('0') to the (GYR 0x11) *suspend* bit with bit (GYR 0x12) *fast_power_up* set to '1'.

7.1.1 Advanced power-saving modes

In addition to the power modes described in figure 13, there are other advanced power modes that can be used to optimize the power consumption of the BMI055.

The *power_save_mode* is set by setting *power_save_mode*='1' (GYR 0x12). This power mode implements a duty cycle and change between normal mode and fast-power-up mode. By setting the *sleep_dur* (time in ms in fast-power-up mode) (GYR 0x11 bits <1:3>) and *auto_sleep_dur* (time in ms in normal mode) (GYR 0x12 bits <0:2>) different timings can be

used. Some of these settings allow the sensor to consume less than 3mA. See also diagram below:

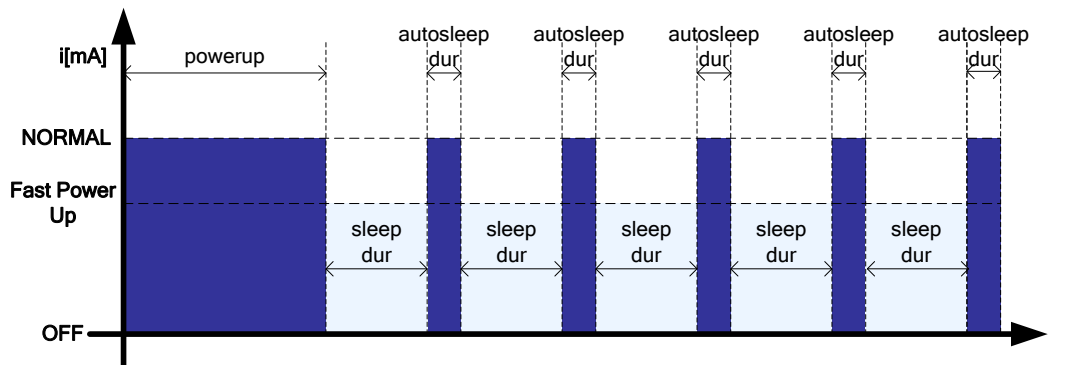

Figure 14: Duty-cycling

The possible configuration for the autosleep_dur and sleep_dur are indicated in the table below:

Table 23

sleep_dur<2:0>	Time (ms)
'000'	2 ms
'001'	4 ms
'010'	5 ms
'011'	8 ms
'100'	10 ms
'101'	15 ms
'110'	18 ms
'111'	20 ms

Table 24

autosleep_dur<2:0>	Time (ms)
'000'	Not allowed
'001'	4 ms
'010'	5 ms
'011'	8 ms
'100'	10 ms
'101'	15 ms
'110'	20 ms
'111'	40 ms

The only restriction for the use of the power save mode comes from the configuration of the digital filter bandwidth (*GYR 0x10*). For each Bandwidth configuration, a minimum autosleep_dur must be ensured. For example, for Bandwidth=47Hz, the minimum autosleep_dur is 5ms. This is specified in the table below. For sleep_dur there is no restriction.

Table 25

bw<3:0>	Bandwidth (Hz)	Mini Autosleep_dur (ms)
'0111'	32 Hz	20 ms
'0110'	64 Hz	10 ms
'0101'	12 Hz	20 ms
'0100'	23 Hz	10 ms
'0011'	47 Hz	5 ms
'0010'	116 Hz	4 ms
'0001'	230 Hz	4 ms
'0000'	Unfiltered (523Hz)	4 ms

7.2 IMU Data Gyro

7.2.1 Rate data

The angular rate data can be read-out through addresses *GYR 0x02* through *GYR 0x07*. The angular rate data is in 2's complement form according to table 26 below. In order to not corrupt the angular rate data, the LSB should always be read out first. Once the LSB of the x,y, or z read-out registers have been read, the MSBs are locked until the MSBs are read out.

This default behavior can be switched off by setting the address (*GYR 0x13*) bit 6 (*shadow_dis*) = '1'. In this case there is no MSB locking, and the data is updated between each read.

The burst-access mechanism provides an efficient way to read out the angular rate data in I²C or SPI mode. During a burst-access, the gyro automatically increments the starting read address after each byte. Any address in the user space can be used as a starting address. When the address (*GYR 0x3F* – *fifo_data*) is reached, the address counter is stopped. In the user space address range, the (*GYR 0x3F* – *fifo_data*) will be continuously read out until burst read ends. It is also possible to start directly with address *0x3F*. In this case, the *fifo_data* (*GYR 0x3F*) data will be read out continuously. The burst-access allows data to be transferred over the I²C bus with an up to 50% reduced data density. The angular rate data in all read-out registers is locked as long as the burst read access is active. Reading the chip angular rate registers in burst read access mode ensures that the angular rate values in all readout registers belong to the same sample.

Table 26: Gyroscope register content for 16bit mode

Decimal value	Angular rate (in 2000°/s range mode)
+32767	+ 2000°/s
...	...
0	0°/s
...	...
-32767	- 2000°/s

Per default, the bandwidth of the data being read-out is limited by the internal low-pass filters according to the filter configuration. Unfiltered (high-bandwidth) data can be read out through the serial interface when the *data_high_bw* (*GYR 0x13* bit 7) is set to '1'.

7.3 Angular rate Read-Out

Bandwidth configuration: The gyro processes the 2kHz data out of the analog front end with a CIC/Decimation filter, followed by an IIR filter before sending this data to the interrupt handler. The possible decimation factors are 2, 5, 10 and 20. It is also possible to bypass these filters, and use the unfiltered 2kHz data. The decimation factor / bandwidth of the filter can be set by setting the address space GYR 0x10 bits<3:0> (bw<3:0>) as shown in the memory map section.

7.4 Self-test Gyro

A built-in self test (BIST) facility has been implemented which provides a quick way to determine if the gyroscope is operational within the specified conditions.

The BIST uses three parameters for evaluation of proper device operation:

- Drive voltage regulator
- Sense frontend offset regulator of x-,y- and z-channel
- Quad regulator for x-,y- and z-channel

If any of the three parameters is not within the limits the BIST result will be “Fail”.

To trigger the BIST 'bit0' bite_trig in address GYR 0x3C must be set '1'. When the test is performed, bit1 bist_rdy will be '1'. If the result is failed the bit bist_failed will be set to '1', otherwise stay a '0'.

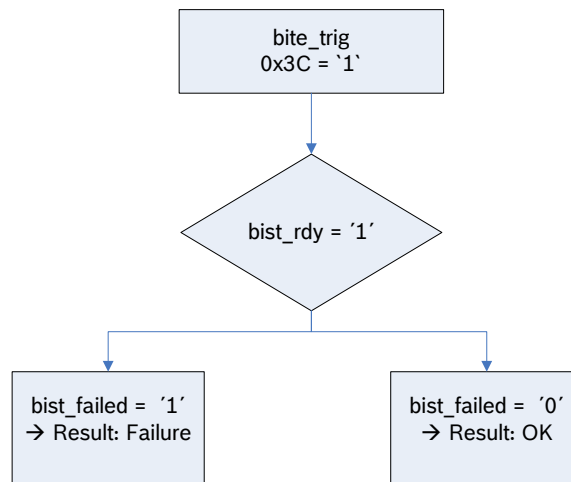

Figure 15: Flow Diagram

Another possibility to get information about the sensor status is to read out rate_ok GYR 0x3C bit4. '1' indicates proper sensor function, no trigger is needed for this.

7.5 Offset compensation gyroscope

Offsets in measured signals can have several causes but they are always unwanted and disturbing in many cases. Therefore, the gyro offers an advanced set of four digital offset compensation methods which are closely matched to each other. These are slow, fast, and manual compensation as well as inline calibration.

The compensation is performed with filtered data, and is then applied to both, unfiltered and filtered data. If necessary the result of this computation is saturated to prevent any overflow errors (the smallest or biggest possible value is set, depending on the sign). However, the registers used to read and write compensation values have a width of 8 bits.

The public offset compensation registers (*GYR 0x36*) to (*GYR 0x39*) are image of the corresponding registers in the NVM. With each image update (see section 7.6 Non-volatile memory gyroscope for details) the contents of the NVM registers are written to the public registers. The public register can be over-written by the user at any time.

In case an internally computed compensation value is too small or too large to fit into the corresponding register, it is saturated in order to prevent an overflow error.

For every axes an offset up to 125°/s with 12 bits full resolution can be calibrated (resolution 0.06°/s).

The modes will be controlled using SPI/I²C commands.

By writing '1' to the (*GYR 0x21*) *offset_reset* bit, all dynamic (fast & slow) offset compensation registers are reset to zero.

7.5.1 Slow compensation

In slow regulation mode, the rate data is monitored permanently. If the rate data is above 0°/s for a certain period of time, an adjustable rate is subtracted by the offset controller. This procedure of monitoring the rate data and subtracting of the adjustable rate at a time is repeated continuously. Thus, the output of the offset converges to 0°/s.

The slow regulation can be enabled through the *slow_offset_en_x/y/z* (*GYR 0x31 <0:2>*) bits for each axis. The slow offset cancellation will work for filtered and unfiltered data (*slow_offset_unfilt* (*GYR 0x1A <5>*); *slow_offset_unfilt=1* → unfiltered data are selected)

Slow Offset cancellation settings are the adjustable rate (*slow_offset_th 0x31 <7:6>*) and the time period (*slow_offset_dur 0x31 <5:3>*)

7.5.2 Fast compensation

A fast offset cancellation controller is implemented in gyro. The fast offset cancellation process is triggerable via SPI/I²C.

The fast offset cancellation can be enabled through the *fast_offset_en_x/y/z* (*GYR 0x32 <0:2>*) bits for each axis. The enable bits will not start the fast offset cancellation! The fast offset cancellation has to be started by setting the *fast_offset_en* (*GYR 0x32 <3>*) bit. Afterwards the algorithm will start and if the algorithm is finished the *fast_offset_en* (*GYR 0x32 <3>*) will be reset to 0.

The fast offset cancellation will work for filtered and unfiltered data (*fast_offset_unfilt* (*GYR 0x1B <7>*); *fast_offset_unfilt=1* → unfiltered data are selected)

The fast offset cancellation parameters are `fast_offset_wordlength` (GYR 0x32 <5:4>)

The sample rate for the fast offset cancellation corresponds to the sample rate of the selected bandwidth. For unfiltered data and bandwidth settings 0-2 the sample rate for the fast offset cancellation will be 400Hz.

The resolution of the calculated offset values for the fast offset compensation depends on the, range setting being less accurate for higher range (e.g. range=2000°/s). Therefore we recommend a range setting of range=125°/s for fast offset compensation.

7.5.3 Manual compensation

The contents of the public compensation registers (GYR 0x36 ... 0x39) `offset_x/y/z` can be set manually via the digital interface. It is recommended to write into these registers directly after a new data interrupt has occurred in order not to disturb running offset computations.

Writing to the offset compensation registers is not allowed while the fast compensation procedure is running.

7.5.4 Inline calibration

For certain applications, it is often desirable to calibrate the offset once and to store the compensation values permanently. This can be achieved by using one of the aforementioned offset compensation methods to determine the proper compensation values and then storing these values permanently in the NVM. See section 7.6 Non-volatile memory gyroscope for details of the storing procedure.

Each time the device is reset, the compensation values are loaded from the non-volatile memory into the image registers and used for offset compensation until they are possibly overwritten using one of the other compensation methods.

7.6 Non-volatile memory gyroscope

The entire memory of the gyro consists of three different kinds of registers: hard-wired, volatile, and non-volatile. Part of it can be both read and written by the user. Access to non-volatile memory is only possible through (volatile) image registers.

Altogether, there are eight registers (octets) with NVM backup which are accessible by the user. The addresses of the image registers range from (GYR 0x36) to (GYR 0x3B). While the addresses up to (GYR 0x39) are used for offset compensation (see 7.5 Offset compensation gyroscope), addresses (GYR 0x3A) and (GYR 0x3B) are general purpose registers not linked to any sensor-specific functionality.

The content of the NVM is loaded to the image registers after a reset (either POR or softreset) or after a user request which is performed by writing '1' to the write-only bit (GYR 0x33) `nvm_load`. As long as the image update is in progress, bit (GYR 0x33) `nvm_rdy` is '0', otherwise it is '1'. In order to read out the correct values (after NVM loading) waiting time is min. 1ms.

The image registers can be read and written like any other register.

Writing to the NVM is a three-step procedure:

4. Write the new contents to the image registers.
5. Write '1' to bit (*GYR 0x33*) *nvm_prog_mode* in order to unlock the NVM.
6. Write '1' to bit (*GYR 0x33*) *nvm_prog_trig* and keep '1' in bit (*GYR 0x33*) *nvm_prog_mode* in order to trigger the write process.

Writing to the NVM always renews the entire NVM contents. It is possible to check the write status by reading bit (*GYR 0x33*) *nvm_rdy*. While (*GYR 0x33*) *nvm_rdy* = '0', the write process is still in progress; if (*GYR 0x33*) *nvm_rdy* = '1', then writing is completed. As long as the write process is ongoing, no change of power mode and image registers is allowed. Also, the NVM write cycle must not be initiated while image registers are updated, in suspend mode.

Please note that the number of permitted NVM write-cycles is limited as specified in table 3. The number of remaining write-cycles can be obtained by reading bits (*GYR 0x33*) *nvm_remain*.

7.7 Interrupt controller Gyro

The gyro is equipped with 3 programmable interrupt engines. Each interrupt can be independently enabled and configured. If the trigger condition of an enabled interrupt is fulfilled, the corresponding status bit is set to '1' and the selected interrupt pin is activated. The gyro provides two interrupt pins, INT3 and INT4; interrupts can be freely mapped to any of these pins. The state of a specific interrupt pin is derived from a logic 'or' combination of all interrupts mapped to it.

The interrupt status registers are updated when a new data word is written into the rate data registers. If an interrupt is disabled, all active status bits associated with it are immediately reset.

Gyro Interrupts are fully functional in normal mode, only. Interrupts are limited in their functionality in other operation modes. Please contact our technical support for further assistance.

7.7.1 General features

An interrupt is cleared depending on the selected interrupt mode, which is common to all interrupts. There are three different interrupt modes: non-latched, latched, and temporary. The mode is selected by the (*GYR 0x21*) *latch_int* bits according to table 27.

Table 27: Interrupt mode selection

(GYR 0x21) latch_int	Interrupt mode
0000b	non-latched
0001b	temporary, 250ms
0010b	temporary, 500ms
0011b	temporary, 1s
0100b	temporary, 2s
0101b	temporary, 4s
0110b	temporary, 8s
0111b	latched
1000b	non-latched
1001b	temporary, 250µs
1010b	temporary, 500µs
1011b	temporary, 1ms
1100b	temporary, 12.5ms
1101b	temporary, 25ms
1110b	temporary, 50ms
1111b	latched

An interrupt is generated if its activation condition is met. It can not be cleared as long as the activation condition is fulfilled. In the non-latched mode the interrupt status bit and the selected pin (the contribution to the 'or' condition for INT3 and/or INT4) are cleared as soon as the activation condition is no more valid. Exception to this behavior is the new data interrupt which is automatically reset after a fixed time.

In latched mode an asserted interrupt status and the selected pin are cleared by writing '1' to bit (GYR 0x21) *reset_int*. If the activation condition still holds when it is cleared, the interrupt status is asserted again with the next change of the rate registers.

In the temporary mode an asserted interrupt and selected pin are cleared after a defined period of time. The behavior of the different interrupt modes is shown graphically in figure 16. The timings in this mode are subject to the same tolerances as the bandwidths (see table 3).

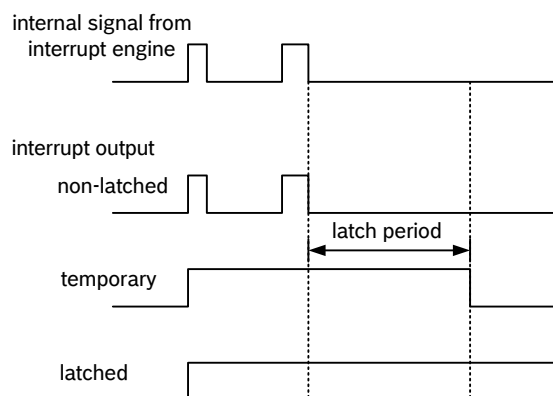

Figure 16: Interrupt modes

7.7.2 Mapping to physical interrupt pins (inttype to INT Pin#)

Registers (*GYR 0x17*) to (*GYR 0x19*) are dedicated to mapping of interrupts to the interrupt pins “INT3” or “INT4”. Setting (*GYR 0x17*) *int1_”inttype”* to ‘1’ (‘0’) maps (unmaps) “inttype” to pin “INT3”. Correspondingly setting (*GYR 0x19*) *int2_”inttype”* to ‘1’ (‘0’) maps (unmaps) “inttype” to pin “INT4”.

Note: “inttype” has to be replaced with the precise notation, given in the memory map in chapter 8.

7.7.3 Electrical behavior (INT pin# to open-drive or push-pull)

Both interrupt pins can be configured to show the desired electrical behavior. The ‘active’ level of each interrupt pin is determined by the (*GYR 0x16*) *int1_lvl* and (*GYR 0x16*) *int2_lvl* bits.

If (*GYR 0x16*) *int1_lvl* = ‘1’ (‘0’) / (*GYR 0x16*) *int2_lvl* = ‘1’ (‘0’), then pin “INT3” / pin “INT4” is active ‘1’ (‘0’). The characteristic of the output driver of the interrupt pins may be configured with bits (*GYR 0x16*) *int1_od* and (*GYR 0x16*) *int2_od*. By setting bits (*GYR 0x16*) *int1_od* / (*GYR 0x16*) *int2_od* to ‘1’, the output driver shows open-drive characteristic, by setting the configuration bits to ‘0’, the output driver shows push-pull characteristic. When open-drive characteristic is selected in the design, external pull-up or pull-down resistor should be applied according the *int_lvl* configuration. When open-drive characteristic is selected in the design, external pull-up or pull-down resistor should be applied according the *int_lvl* configuration.

7.7.4 New data interrupt

This interrupt serves for synchronous reading of angular rate data. It is generated after storing a new value of z-axis angular rate data in the data register. The interrupt is cleared automatically after 280-400 μs (depending on Interrupt settings).

The interrupt mode of the new data interrupt is fixed to non-latched.

It is enabled (disabled) by writing ‘1’ (‘0’) to bit (*GYR 0x15*) *data_en*. The interrupt status is stored in bit (*GYR 0x0A*) *data_int*.

7.7.5 Any-motion detection / Interrupt

Any-motion (slope) detection uses the slope between successive angular rate signals to detect changes in motion. An interrupt is generated when the slope (absolute value of angular rate difference) exceeds a preset threshold. It is cleared as soon as the slope falls below the threshold. The principle is made clear in figure 17.

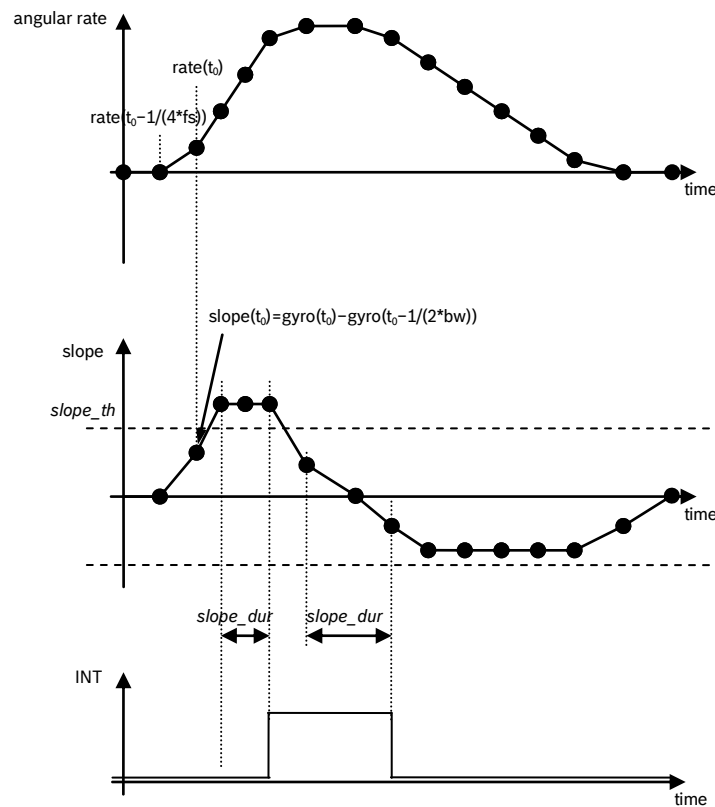

Figure 17: Principle of any-motion detection,(will be updated)

The threshold is defined through register (*GYR 0x1B*) *any_th*. In terms of scaling 1 LSB of (*GYR 0x1B*) *any_th* corresponds to 1 °/s in 2000°/s-range (0.5°/s in 1000°/s-range, 0.25°/s in 500°/s –range ...). Therefore the maximum value is 125°/s in 2000°/s-range (62.5°/s 1000°/s-range, 31.25°/s in 500°/s –range ...).

The time difference between the successive angular rate signals depends on the selected update rate(*fs*) which is coupled to the bandwidth and equates to $1/(4*fs)$ ($t=1/(4*fs)$). For bandwidth settings with an update rate higher than 400Hz (bandwidth =0, 1, 2) *fs* is set to 400Hz.

In order to suppress false triggers, the interrupt is only generated (cleared) if a certain number *N* of consecutive slope data points is larger (smaller) than the slope threshold given by (*GYR 0x1B*) *any_th*. This number is set by the (*GYR 0x1C*) *any_dursample* bits. It is $N = [(GYR 0x1C) any_dursample + 1]*4$ for (*GYR 0x1C*). *N* is set in samples. Thus the time is scaling with the update rate (*fs*). Example: (*GYR 0x1C*) *slope_dur* = 00b, ..., 11b = 4 samples, ..., 16 samples.

7.7.5.1 Enabling (disabling) for each axis

Any-motion detection can be enabled (disabled) for each axis separately by writing '1' ('0') to bits (*GYR 0x1C*) *any_en_x*, (*GYR 0x1C*) *any_en_y*, (*GYR 0x1C*) *any_en_z*. The criteria for any-motion detection are fulfilled and the Any-Motion interrupt is generated if the slope of any of the enabled axes exceeds the threshold (*GYR 0x1B*) *any_th* for $[(GYR 0x1C) slope_dur + 1]*4$ consecutive times. As soon as the slopes of all enabled axes fall or stay below this threshold for $[(GYR 0x1C) slope_dur + 1]*4$ consecutive times the interrupt is cleared unless interrupt signal is latched.

7.7.5.2 Axis and sign information of slope / any motion interrupt

The interrupt status is stored in bit (*GYR 0x09*) *any_int*. The Any-motion interrupt supplies additional information about the detected slope. The axis which triggered the interrupt is given by that one of bits (*GYR 0x0B*) *any_first_x*, (*GYR 0x0B*) *any_first_y*, (*GYR 0x0B*) *any_first_z* that contains a value of '1'. The sign of the triggering slope is held in bit (*GYR 0x0B*) *any_sign* until the interrupt is retriggered. If (*GYR 0x0B*) *slope_sign* = '1' ('0'), the sign is positive (negative).

7.7.6 High-Rate interrupt

This interrupt is based on the comparison of angular rate data against a high-rate threshold for the detection of shock or other high-angular rate events. The principle is made clear in figure 18 below:

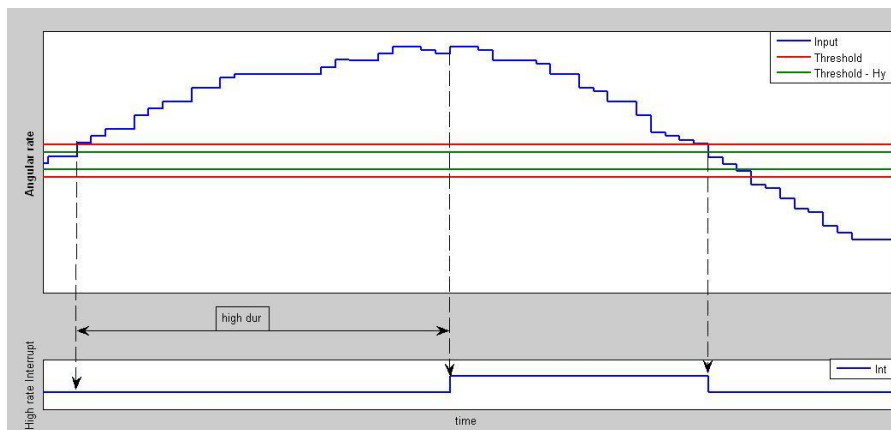

Figure 18: High rate interrupt

The high-rate interrupt is enabled (disabled) per axis by writing '1' ('0') to bits (*GYR 0x22*) *high_en_x*, (*GYR 0x24*) *high_en_y*, and (*GYR 0x26*) *high_en_z*, respectively. The high-rate threshold is set through the (*GYR 0x22*) *high_th_x* register, (*GYR 0x24*) *high_th_y* register and (*GYR 0x26*) *high_th_z* for the corresponding axes. The meaning of an LSB of (*GYR 0x22/24/26*) *high_th_x/y/z* depends on the selected $^{\circ}/s$ -range: it corresponds to 62.5 $^{\circ}/s$ in 2000 $^{\circ}/s$ -range, 31.25 $^{\circ}/s$ in 1000 $^{\circ}/s$ -range, 15.625 $^{\circ}/s$ in 500 $^{\circ}/s$ -range ...). The *high_th_x/y/z* register setting 0 corresponds to 62.26 $^{\circ}/s$ in 2000 $^{\circ}/s$ -range, 31.13 $^{\circ}/s$ in 1000 $^{\circ}/s$ -range, 15.56 $^{\circ}/s$ in 500 $^{\circ}/s$ -range Therefore the maximum value is 1999.76 $^{\circ}/s$ in 2000 $^{\circ}/s$ -range (999.87 $^{\circ}/s$ 1000 $^{\circ}/s$ -range, 499.93 $^{\circ}/s$ in 500 $^{\circ}/s$ -range ...).

A hysteresis can be selected by setting the (*GYR 0x22/24/26*) *high_hy_x/y/z* bits. Analogously to (*GYR 0x22/24/26*) *high_th_x/y/z*, the meaning of an LSB of (*GYR 0x22/24/26*) *high_hy_x/y/z* bits is $^{\circ}/s$ -range dependent: The *high_hy_x/y/z* register setting 0 corresponds to an angular rate difference of 62.26 $^{\circ}/s$ in 2000 $^{\circ}/s$ -range, 31.13 $^{\circ}/s$ in 1000 $^{\circ}/s$ -range, 15.56 $^{\circ}/s$ in 500 $^{\circ}/s$ -range The meaning of an LSB of (*GYR 0x22/24/26*) *high_hy_x/y/z* depends on the selected $^{\circ}/s$ -range too: it corresponds to 62.5 $^{\circ}/s$ in 2000 $^{\circ}/s$ -range, 31.25 $^{\circ}/s$ in 1000 $^{\circ}/s$ -range, 15.625 $^{\circ}/s$ in 500 $^{\circ}/s$ -range ...).

The high-rate interrupt is generated if the absolute value of the angular rate of at least one of the enabled axes ('or' relation) is higher than the threshold for at least the time defined by the

(GYR 0x23/25/27) *high_dur_x/y/z* register. The interrupt is reset if the absolute value of the angular rate of all enabled axes ('and' relation) is lower than the threshold minus the hysteresis. In bit (GYR 0x09) *high_int* the interrupt status is stored. The relation between the content of (GYR 0x23/25/27) *high_dur_x/y/z* and the actual delay of the interrupt generation is $\text{delay [ms]} = [(GYR 0x23/25/27) \text{ high_dur_x/y/z} + 1] * 2.5 \text{ ms}$. Therefore, possible delay times range from 2.5 ms to 640 ms.

7.7.6.1 Axis and sign information of high-rate interrupt

The axis which triggered the interrupt is indicated by bits (GYR 0x0C) *high_first_x*, (GYR 0x0C) *high_first_y*, and (GYR 0x0C) *high_first_z*. The bit corresponding to the triggering axis contains a '1' while the other bits hold a '0'. These bits are cleared together with clearing the interrupt status. The sign of the triggering angular rate is stored in bit (GYR 0x0C) *high_sign*. If (GYR 0x0C) *high_sign* = '1' ('0'), the sign is positive (negative).

8. Register description gyroscope

8.1 General remarks

The entire communication with the device is performed by reading from and writing to registers. Registers have a width of 8 bits; they are mapped to a common space of 64 addresses from (*GYR 0x00*) up to (*GYR 0x3F*). Within the used range there are several registers which are either completely or partially marked as 'reserved'. Any reserved bit is ignored when it is written and no specific value is guaranteed when read. It is recommended not to use registers at all which are completely marked as 'reserved'. Furthermore it is recommended to mask out (logical *and* with zero) reserved bits of registers which are partially marked as reserved.

Registers with addresses from (*GYR 0x00*) up to (*GYR 0x0E*) are read-only. Any attempt to write to these registers is ignored. There are bits within some registers that trigger internal sequences. These bits are configured for write-only access, e. g. (*GYR 0x21*) *reset_int* or the entire (*GYR 0x14*) *softreset* register, and read as value '0'.

8.2 Register map gyroscope

Register Address	bit7	bit6	bit5	bit4	bit3	bit2	bit1	bit0	Access	Reset Value	
0x0F	fifo_data[7]	fifo_data[6]	fifo_data[5]	fifo_data[4]	fifo_data[3]	fifo_data[2]	fifo_data[1]	fifo_data[0]	ro	0x00	
0x0E	mode[1]	mode[0]					data_select[1]	data_select[0]	wr	0x00	
0x0D	tag	h2o_mrk_M_trig_re[6]	h2o_mrk_M_trig_re[5]	h2o_mrk_M_trig_re[4]	h2o_mrk_M_trig_re[3]	h2o_mrk_M_trig_re[2]	h2o_mrk_M_trig_re[1]	h2o_mrk_M_trig_re[0]	wr	0x00	
0x0C				rate_ok			bist_fail	trig_bist	ro	NA	
0x0B	gp0[11]	gp0[10]	gp0[9]	gp0[8]	gp0[7]	gp0[6]	gp0[5]	gp0[4]	wr	NA	
0x0A	gp0[3]	gp0[2]	gp0[1]	gp0[0]	offset_x[1]	offset_x[0]	offset_y[0]	offset_z[0]	wr	NA	
0x09	offset_z[11]	offset_z[10]	offset_z[9]	offset_z[8]	offset_z[7]	offset_z[6]	offset_z[5]	offset_z[4]	wr	NA	
0x08	offset_y[11]	offset_y[10]	offset_y[9]	offset_y[8]	offset_y[7]	offset_y[6]	offset_y[5]	offset_y[4]	wr	NA	
0x07	offset_x[11]	offset_x[10]	offset_x[9]	offset_x[8]	offset_x[7]	offset_x[6]	offset_x[5]	offset_x[4]	wr	NA	
0x06	offset_x[3]	offset_x[2]	offset_x[1]	offset_x[0]	offset_y[1]	offset_y[0]	offset_z[1]	offset_z[0]	wr	NA	
0x05									wr	0x00	
0x04			ext_fifo_sc_en	ext_fifo_sel	burst_same_en	i2c_wdt_en	i2c_wdt_sel	spi3	wr	0x00	
0x03	nvm_remain[3]	nvm_remain[2]	nvm_remain[1]	nvm_remain[0]	nvm_load	nvm_rdy	nvm_prog_trig	nvm_prog_mode	wr	0x00	
0x02	auto_offset_wordlength[11]	auto_offset_wordlength[0]	fast_offset_wordlength[11]	fast_offset_wordlength[0]	fast_offset_en	fast_offset_en_z	fast_offset_en_y	fast_offset_en_x	wr	0x00	
0x01	slow_offset_int[1]	slow_offset_int[0]	slow_offset_dur[2]	slow_offset_dur[1]	slow_offset_dur[0]	slow_offset_en_z	slow_offset_en_y	slow_offset_en_x	wr	0x00	
0x00									wr	0x00	
0x2F									wr	0x00	
0x2E									wr	0x00	
0x2D									wr	0x00	
0x2C									wr	0x00	
0x2B									wr	0x00	
0x2A									wr	0x00	
0x29									wr	0x00	
0x28									wr	0x00	
0x27	high_dur_z[7]	high_dur_z[6]	high_dur_z[5]	high_dur_z[4]	high_dur_z[3]	high_dur_z[2]	high_dur_z[1]	high_dur_z[0]	wr	0x00	
0x26	high_hy_z[1]	high_hy_z[0]	high_th_z[4]	high_th_z[3]	high_th_z[2]	high_th_z[1]	high_th_z[0]	high_en_z	wr	0x00	
0x25	high_dur_y[7]	high_dur_y[6]	high_dur_y[5]	high_dur_y[4]	high_dur_y[3]	high_dur_y[2]	high_dur_y[1]	high_dur_y[0]	wr	0x00	
0x24	high_hy_y[1]	high_hy_y[0]	high_th_y[4]	high_th_y[3]	high_th_y[2]	high_th_y[1]	high_th_y[0]	high_en_y	wr	0x00	
0x23	high_dur_x[7]	high_dur_x[6]	high_dur_x[5]	high_dur_x[4]	high_dur_x[3]	high_dur_x[2]	high_dur_x[1]	high_dur_x[0]	wr	0x00	
0x22	high_hy_x[1]	high_hy_x[0]	high_th_x[4]	high_th_x[3]	high_th_x[2]	high_th_x[1]	high_th_x[0]	high_en_x	wr	0x00	
0x21	reset_int	offset_reset		latch_status_bits	latch_int[3]	latch_int[2]	latch_int[1]	latch_int[0]	wr	0x00	
0x20									wr	0x00	
0x1F									wr	0x00	
0x1E	fifo_wm_en								wr	0x00	
0x1D									wr	0x00	
0x1C	awake_dur[1]	awake_dur[0]	any_dursample[1]	any_dursample[0]			any_en_z	any_en_y	any_en_x	wr	0x00
0x1B	fast_offset_unfilt	any_th[6]	any_th[5]	any_th[4]	any_th[3]	any_th[2]	any_th[1]	any_th[0]	wr	0x00	
0x1A			slow_offset_unfilt		high_unfilt_data	int2_high	int1_auto_offset	int2_high	int1_auto_offset	wr	0x00
0x19					int2_high	int1_auto_offset	int1_fifo	int1_fast_offset	int1_data	wr	0x00
0x18	int2_data	int2_fast_offset	int2_fifo	int2_auto_offset	int1_auto_offset	int1_fifo	int1_fast_offset	int1_data	wr	0x00	
0x17					int1_high	int1_od	int1_od	int1_M	wr	0x00	
0x16					int2_od	int2_M	int1_od	int1_M	wr	0x00	
0x15	data_en	fifo_en				auto_offset_en			wr	0x00	
0x14	softreset[7]	softreset[6]	softreset[5]	softreset[4]	softreset[3]	softreset[2]	softreset[1]	softreset[0]	wo	0x00	
0x13	data_high_bw	shadow_ds							wo	0x00	
0x12	fast_powerup	power_save_mode	ext_trig_sel[1]	ext_trig_sel[0]		autosleep_dur[2]	autosleep_dur[1]	autosleep_dur[0]	wr	0x00	
0x11	suspend	deep_suspend			sleep_dur[2]	sleep_dur[1]	sleep_dur[0]		wr	0x00	
0x10					bw[3]	bw[2]	bw[1]	bw[0]	wr	0x00	
0x0F						range[2]	range[1]	range[0]	wr	0x00	
0x0E	Overrun	frame_counter[6]	frame_counter[5]	frame_counter[4]	frame_counter[3]	frame_counter[2]	frame_counter[1]	frame_counter[0]	ro	0x00	
0x0D									ro	0x00	
0x0C					high_sign	high_first_z	high_first_y	high_first_x	ro	0x00	
0x0B					any_sign	any_first_z	any_first_y	any_first_x	ro	0x00	
0x0A	data_int	auto_offset_int	fast_offset_int	fifo_int					ro	0x00	
0x09						any_int	high_int		ro	0x00	
0x08	rate_z[15]	rate_z[14]	rate_z[13]	rate_z[12]	rate_z[11]	rate_z[10]	rate_z[9]	rate_z[8]	ro	0x00	
0x07	rate_z[7]	rate_z[6]	rate_z[5]	rate_z[4]	rate_z[3]	rate_z[2]	rate_z[1]	rate_z[0]	ro	0x00	
0x06	rate_y[15]	rate_y[14]	rate_y[13]	rate_y[12]	rate_y[11]	rate_y[10]	rate_y[9]	rate_y[8]	ro	0x00	
0x05	rate_y[7]	rate_y[6]	rate_y[5]	rate_y[4]	rate_y[3]	rate_y[2]	rate_y[1]	rate_y[0]	ro	0x00	
0x04	rate_x[15]	rate_x[14]	rate_x[13]	rate_x[12]	rate_x[11]	rate_x[10]	rate_x[9]	rate_x[8]	ro	0x00	
0x03	rate_x[7]	rate_x[6]	rate_x[5]	rate_x[4]	rate_x[3]	rate_x[2]	rate_x[1]	rate_x[0]	ro	0x00	
0x02									ro	0x00	
0x01	chip_id[7]	chip_id[6]	chip_id[5]	chip_id[4]	chip_id[3]	chip_id[2]	chip_id[1]	chip_id[0]	ro	0x00	

	wr
	write only
	read only
	res. future use

common w/r registers: Application specific settings which are not equal to the default settings, must be re-set to its designated values after POR, soft-reset and wake up from deep suspend.
user w/r registers: Initial default content = 0x00. Freely programmable by the user.
 Remains unchanged after POR, soft-reset and wake up from deep suspend.

Figure 19: Register map gyroscope

GYR Register 0x00 (CHIP_ID)

The register contains the chip identification code.

Name	0x00	CHIP_ID		
Bit	7	6	5	4
Read/Write	R	R	R	R
Reset Value	n/a	n/a	n/a	n/a
Content	chip_id<7:4>			
Bit	3	2	1	0
Read/Write	R	R	R	R
Reset Value	n/a	n/a	n/a	n/a
Content	chip_id<3:0>			

chip_id<7:0>: Fixed value b'0000'1111 =0x0F

GYR Register 0x01 is reserved

GYR Register 0x02 (RATE_X_LSB)

The register contains the least-significant bits of the X-channel angular rate readout value. When reading out X-channel angular rate values, data consistency is guaranteed if the RATE_X_LSB is read out before the RATE_X_MSB and shadow_dis='0'. In this case, after the RATE_X_LSB has been read, the value in the RATE_X_MSB register is locked until the RATE_X_MSB has been read. This condition is inherently fulfilled if a burst-mode read access is performed. Angular rate data may be read from register RATE_X_LSB at any time except during power-up and in DEEP_SUSPEND mode.

Name	0x02	RATE_X_LSB		
Bit	7	6	5	4
Read/Write	R	R	R	R
Reset Value	n/a	n/a	n/a	n/a
Content	rate_x_lsb<7:4>			
Bit	3	2	1	0
Read/Write	R	R	R	R
Reset Value	n/a	n/a	n/a	n/a
Content	rate_x_lsb<3:0>			

rate_x_lsb<7:0>: Least significant 8 bits of rate read-back value; (two's-complement format)

GYR Register 0x03 (RATE_X_MSB)

The register contains the most-significant bits of the X-channel angular rate readout value. When reading out X-channel angular rate values, data consistency is guaranteed if the RATE_X_LSB is read out before the RATE_X_MSB and shadow_dis='0'. In this case, after the RATE_X_LSB has been read, the value in the RATE_X_MSB register is locked until the RATE_X_MSB has been read. This condition is inherently fulfilled if a burst-mode read access is performed. Angular rate data may be read from register RATE_X_MSB at any time except during power-up and in DEEP_SUSPEND mode.

Name	0x03	RATE_X_MSB		
Bit	7	6	5	4
Read/Write	R	R	R	R
Reset Value	n/a	n/a	n/a	n/a
Content	rate_x_msb<15:12>			
Bit	3	2	1	0
Read/Write	R	R	R	R
Reset Value	n/a	n/a	n/a	n/a
Content	rate_x_msb<11:8>			

rate_x_msb<15:8>: Most significant 8 bits of rate read-back value (two's-complement format)

GYR Register 0x04 (RATE_Y_LSB)

The register contains the least-significant bits of the Y-channel angular rate readout value. When reading out Y-channel angular rate values, data consistency is guaranteed if the RATE_Y_LSB is read out before the RATE_Y_MSB and shadow_dis='0'. In this case, after the RATE_Y_LSB has been read, the value in the RATE_Y_MSB register is locked until the RATE_Y_MSB has been read. This condition is inherently fulfilled if a burst-mode read access is performed. Angular rate data may be read from register RATE_Y_LSB at any time except during power-up and in DEEP_SUSPEND mode.

Name	0x04	RATE_Y_LSB		
Bit	7	6	5	4
Read/Write	R	R	R	R
Reset Value	n/a	n/a	n/a	n/a
Content	rate_y_lsb<7:4>			
Bit	3	2	1	0
Read/Write	R	R	R	R
Reset Value	n/a	n/a	n/a	n/a
Content	rate_y_lsb<3:0>			

rate_y_lsb<7:0>: Least significant 8 bits of rate read-back value; (two's-complement format)

GYR Register 0x05 (RATE_Y_MSB)

The register contains the most-significant bits of the Y-channel angular rate readout value. When reading out Y-channel angular rate values, data consistency is guaranteed if the RATE_Y_LSB is read out before the RATE_Y_MSB and shadow_dis='0'. In this case, after the RATE_Y_LSB has been read, the value in the RATE_Y_MSB register is locked until the RATE_Y_MSB has been read. This condition is inherently fulfilled if a burst-mode read access is performed. Angular rate data may be read from register RATE_Y_MSB at any time except during power-up and in DEEP_SUSPEND mode.

Name	0x05	RATE_Y_MSB		
Bit	7	6	5	4
Read/Write	R	R	R	R
Reset Value	n/a	n/a	n/a	n/a
Content	rate_y_msb<15:12>			
Bit	3	2	1	0
Read/Write	R	R	R	R
Reset Value	n/a	n/a	n/a	n/a
Content	rate_y_msb<11:8>			

rate_y_msb<15:8>: Most significant 8 bits of rate read-back value (two's-complement format)

GYR Register 0x06 (RATE_Z_LSB)

The register contains the least-significant bits of the Z-channel angular rate readout value. When reading out Z-channel angular rate values, data consistency is guaranteed if the RATE_Z_LSB is read out before the RATE_Z_MSB and shadow_dis='0'. In this case, after the RATE_Z_LSB has been read, the value in the RATE_Z_MSB register is locked until the RATE_Z_MSB has been read. This condition is inherently fulfilled if a burst-mode read access is performed. Angular rate data may be read from register RATE_Z_LSB at any time except during power-up and in DEEP_SUSPEND mode.

Name	0x06	RATE_Z_LSB		
Bit	7	6	5	4
Read/Write	R	R	R	R
Reset Value	n/a	n/a	n/a	n/a
Content	rate_z_lsb<7:4>			
Bit	3	2	1	0
Read/Write	R	R	R	R
Reset Value	n/a	n/a	n/a	n/a
Content	rate_z_lsb<3:0>			

rate_z_lsb<7:0>: Least significant 8 bits of rate read-back value; (two's-complement format)

GYR Register 0x07 (RATE_Z_MSB)

The register contains the most-significant bits of the Z-channel angular rate readout value. When reading out Z-channel angular rate values, data consistency is guaranteed if the RATE_Z_LSB is read out before the RATE_Z_MSB and shadow_dis='0'. In this case, after the RATE_Z_LSB has been read, the value in the RATE_Z_MSB register is locked until the RATE_Z_MSB has been read. This condition is inherently fulfilled if a burst-mode read access is performed. Angular rate data may be read from register RATE_Z_MSB at any time except during power-up and in DEEP_SUSPEND mode.

Name	0x07	RATE_Z_MSB		
Bit	7	6	5	4
Read/Write	R	R	R	R
Reset Value	n/a	n/a	n/a	n/a
Content	rate_z_msb<15:12>			
Bit	3	2	1	0
Read/Write	R	R	R	R
Reset Value	n/a	n/a	n/a	n/a
Content	rate_z_msb<11:8>			

rate_z_msb<15:8>: Most significant 8 bits of rate read-back value (two's-complement format)

GYR Register 0x08 reserved
GYR Register 0x09 (INT_STATUS_0)

The register contains interrupt status bits. Name	0x09	INT_STATUS_0		
Bit	7	6	5	4
Read/Write	R	R	R	R
Reset Value	n/a	n/a	n/a	n/a
Content	reserved			
Bit	3	2	1	0
Read/Write	R	R	R	R
Reset Value	n/a	n/a	n/a	n/a
Content	reserved	any_int	high_int	reserved

any_int: Any motion interrupt status

high_int: High rate interrupt status

GYR Register 0x0A (INT_STATUS_1)

The register contains interrupt status bits.

Name	0x0A	INT_STATUS_1		
Bit	7	6	5	4
Read/Write	R	R	R	R
Reset Value	n/a	n/a	n/a	n/a
Content	data_int	auto_offset_int	fast_offset_int	fifo_int
Bit	3	2	1	0
Read/Write	R	R	R	R
Reset Value	n/a	n/a	n/a	n/a
Content	reserved			

data_int: New data interrupt status
 auto_offset_int: Auto Offset interrupt status
 fast_offset_int: Fast Offset interrupt status
 fifo_int: Fifo interrupt status

GYR Register 0x0B (INT_STATUS_2)

The register contains any motion interrupt status bits,

Name	0x0B	INT_STATUS_2		
Bit	7	6	5	4
Read/Write	R	R	R	R
Reset Value	n/a	n/a	n/a	n/a
Content	reserved			
Bit	3	2	1	0
Read/Write	R	R	R	R
Reset Value	n/a	n/a	n/a	n/a
Content	any_sign	any_first_z	any_first_y	any_first_x

any_sign: sign of any motion interrupt ('1'= positive, '0'=negative)
 any_first_z: '1' indicates that z-axis is triggering axis of any motion interrupt
 any_first_y: '1' indicates that y-axis is triggering axis of any motion interrupt
 any_first_x: '1' indicates that z-axis is triggering axis of any motion interrupt

GYR Register 0x0C (INT_STATUS_3)

The register contains high rate interrupt status bits.

Name	0x0C	INT_STATUS_3		
Bit	7	6	5	4
Read/Write	R	R	R	R
Reset Value	n/a	n/a	n/a	n/a
Content	reserved			
Bit	3	2	1	0
Read/Write	R	R	R	R
Reset Value	n/a	n/a	n/a	n/a
Content	high_sign	high_first_z	high_first_y	high_first_x

high_sign: sign of high rate interrupt ('1'= positive, '0'=negative)
 high_first_z: '1' indicates that z-axis is triggering axis of high rate interrupt
 high_first_y: '1' indicates that y-axis is triggering axis of high rate interrupt
 high_first_x: '1' indicates that z-axis is triggering axis of high rate interrupt

GYR Register 0x0D is reserved

GYR Register 0x0E (FIFO_STATUS)

The register contains FIFO status flags.

Name	0x0E	FIFO_STATUS		
Bit	7	6	5	4
Read/Write	R	R	R	R
Reset Value	n/a	n/a	n/a	n/a
Content	fifo_overrun	fifo_frame_counter<6:4>		
Bit	3	2	1	0
Read/Write	R	R	R	R
Reset Value	n/a	n/a	n/a	n/a
Content	fifo_frame_counter<3:0>			

fifo_overrun: FIFO overrun condition has '1' → occurred, or '0' → not occurred; flag can be cleared by writing to the FIFO configuration register FIFO_CONFIG_1 only

fifo_frame_counter<6:4>: Current fill level of FIFO buffer. An empty FIFO corresponds to 0x00. The frame counter can be cleared by reading out all frames from the FIFO buffer or writing to the FIFO configuration register FIFO_CONFIG_1.

GYR Register 0x0F (RANGE)

The gyroscope supports four different angular rate measurement ranges. A measurement range is selected by setting the (0x0F) range bits as follows:

Name	0x0F	RANGE		
Bit	7	6	5	4
Read/Write	R/W	R/W	R/W	R/W
Reset Value	0	0	0	0
Content	reserved			
0				
Bit	3	2	1	0
Read/Write	R/W	R/W	R/W	R/W
Reset Value	0	0	0	0
Content	reserved	range<2:0>		

range<2:0>: Angular Rate Range and Resolution.

range<2:0>	Full Scale	Resolution
'000'	±2000°/s	16.4 LSB/°/s ⇔ 61.0 m°/s / LSB
'001'	±1000°/s	32.8 LSB/°/s ⇔ 30.5 m°/s / LSB
'010'	±500°/s	65.6 LSB/°/s ⇔ 15.3 m°/s / LSB
'011'	±250°/s	131.2 LSB/°/s ⇔ 7.6 m°/s / LSB
'100'	±125°/s	262.4 LSB/°/s ⇔ 3.8m°/s / LSB
'101', '110', '111'	reserved	

reserved: write '0'

GYR Register 0x10 (BW)

The register allows the selection of the rate data filter bandwidth.

Name	0x10	BW		
Bit	7	6	5	4
Read/Write	R	R/W	R/W	R/W
Reset Value	1	0	0	0
Content	reserved			
0				
Bit	3	2	1	0
Read/Write	R/W	R/W	R/W	R/W
Reset Value	0	0	0	0
Content	bw<3:0>			

bw<3:0>:

0x10 bits<3:0>	Decimation Factor	ODR	Filter Bandwidth
'0111'	20	100 Hz	32 Hz
'0110'	10	200 Hz	64 Hz
'0101'	20	100 Hz	12 Hz
'0100'	10	200 Hz	23 Hz
'0011'	5	400 Hz	47 Hz
'0010'	2	1000 Hz	116 Hz
'0001'	0	2000 Hz	230 Hz
'0000'	0	2000 Hz	Unfiltered (523Hz)
'1xxx'	Unused / Reserved	Unused / Reserved	Unused / Reserved

reserved: write '0'

GYR Register 0x11 (LPM1)

Selection of the main power modes.

Name	0x11	LPM1		
Bit	7	6	5	4
Read/Write	R/W	R/W	R/W	R/W
Reset Value	0	0	0	0
Content	suspend	reserved	deep_suspend	reserved
Bit	3	2	1	0
Read/Write	R/W	R/W	R/W	R/W
Reset Value	0	0	0	0
Content	sleep_dur[2]	sleep_dur[1]	sleep_dur[0]	reserved

suspend, deep_suspend:

Main power mode configuration setting {suspend; deep_suspend}:

```

{0; 0} → NORMAL mode;
{0; 1} → DEEP_SUSPEND mode;
{1; 0} → SUSPEND mode;
{all other} → illegal
  
```

Please note that only certain power mode transitions are permitted.

Please note, that all application specific settings which are not equal to the default settings (refer to 8.2 register map gyroscope), must be re-set to its designated values after DEEP_SUSPEND.

sleep_dur<2:0>: time in ms in fast-power-up mode under advanced power-saving mode.

sleep_dur<2:0>	Time (ms)
'000'	2 ms
'001'	4 ms
'010'	5 ms
'011'	8 ms
'100'	10 ms
'101'	15 ms
'110'	18 ms
'111'	20 ms

reserved: write '0'

GYR Register 0x12 (LPM2)

Configuration settings for fast power-up and external trigger.

Name	0x12	LPM2		
Bit	7	6	5	4
Read/Write	R/W	R/W	R/W	R/W
Reset Value	0	0	0	0
Content	fast_powerup	power_save_mode	ext_trig_sel[1]	ext_trig_sel[0]
Bit	3	2	1	0
Read/Write	R/W	R/W	R/W	R/W
Reset Value	0	0	0	0
Content	reserved	autosleep_dur[2]	autosleep_dur[1]	autosleep_dur[0]

fast powerup: 1 → Drive stays active for suspend mode in order to have a short wake-up time.....

10 → Drive is switched off for suspend mode

ext_trig_sel<1:0>:

ext_trig_sel<1:0>	Trigger source
'00'	No
'01'	INT1 pin
'10'	INT2 pin
'11'	SDO pin (SPI3 mode)

autosleep<2:0>: time in ms in normal mode under advanced power-saving mode.

autosleep_dur<2:0>	Time (ms)
'000'	Not allowed
'001'	4 ms
'010'	5 ms
'011'	8 ms
'100'	10 ms
'101'	15 ms
'110'	20 ms
'111'	40 ms

reserved: write '0'

GYR Register 0x13 (RATE_HBW)

Angular rate data acquisition and data output format.

Name	0x13	RATE_HBW		
Bit	7	6	5	4
Read/Write	R/W	R/W	R/W	R/W
Reset Value	0	0 (1 in 8-bit mode)	0	0
Content	data_high_bw	shadow_dis	reserved	
Bit	3	2	1	0
Read/Write	R/W	R/W	R/W	R/W
Reset Value	0	0	0	0
Content	reserved			

data_high_bw: select whether '1' → unfiltered, or '0' → filtered data may be read from the rate data registers.

shadow_dis: '1' → disable, or '0' → the shadowing mechanism for the rate data output registers. When shadowing is enabled, the content of the rate data component in the MSB register is locked, when the component in the LSB is read, thereby ensuring the integrity of the rate data during read-out. The lock is removed when the MSB is read.

reserved: write '0'

GYR Register 0x14 (BGW_SOFTRESET)

Controls user triggered reset of the sensor.

Name	0x14				BGW_SOFTRESET			
Bit	7	6	5	4				
Read/Write	W	W	W	W				
Reset Value	0	0	0	0				
Content	softreset							
Bit	3	2	1	0				
Read/Write	W	W	W	W				
Reset Value	0	0	0	0				
Content	softreset							

softreset: 0xB6 → trigger a reset. Other values are ignored. Following a delay, all user configuration settings are overwritten with their default state or the setting stored in the NVM, wherever applicable. This register is functional in all operation modes. Please note, that all application specific settings which are not equal to the default settings (refer to 8.2 register map gyroscope), must be re-set to its designated values.

GYR Register 0x15 (INT_EN_0)

Controls which interrupts are enabled.

Name	0x15				INT_EN_0			
Bit	7	6	5	4				
Read/Write	R/W	R/W	R/W	R/W				
Reset Value	0	0	0	0				
Content	data_en	fifo_en	reserved					
Bit	3	2	1	0				
Read/Write	R/W	R/W	R/W	R/W				
Reset Value	0	0	0	0				
Content	reserved	auto_offset_en	reserved					

data_en: '1' ('0') enables (disables) new data interrupt
 fifo_en : '1' ('0') enables (disables) fifo interrupt
 auto_offset_en : '1' ('0') enables (disables) auto-offset compensation
 reserved : write '0'

GYR Register 0x16 (INT_EN_1)

Contains interrupt pin configurations.

Name	0x16	INT_EN_1		
Bit	7	6	5	4
Read/Write	R/W	R/W	R/W	R/W
Reset Value	0	0	0	0
Content	reserved			
Bit	3	2	1	0
Read/Write	R/W	R/W	R/W	R/W
Reset Value	1	1	1	1
Content	int2_od	int2_lvl	int1_od	int1_lvl

int2_od: '0' ('1') selects push-pull, '1' selects open drive for INT4

int2_lvl: '0' ('1') selects active level '0' ('1') for INT4

int1_od: '0' ('1') selects push-pull, '1' selects open drive for INT3

int1_lvl: '0' ('1') selects active level '0' ('1') for INT3

reserved: write '0'

GYR Register 0x17 (INT_MAP_0)

Controls which interrupt signals are mapped to the INT3 pin.

Name	0x17	INT_MAP_0		
Bit	7	6	5	4
Read/Write	R/W	R/W	R/W	R/W
Reset Value	0	0	0	0
Content	reserved			
Bit	3	2	1	0
Read/Write	R/W	R/W	R/W	R/W
Reset Value	0	0	0	0
Content	int1_high	reserved	int1_any	reserved

int1_high: map high rate interrupt to INT3 pin: '0' → disabled, or '1' → enabled

int1_any: map Any-Motion to INT3 pin: '0' → disabled, or '1' → enabled

reserved: write '0'

GYR Register 0x18 (INT_MAP_1)

Controls which interrupt signals are mapped to the INT3 pin and INT4 pin.

Name	0x1B	INT_MAP_1		
Bit	7	6	5	4
Read/Write	R/W	R/W	R/W	R/W
Reset Value	0	0	0	0
Content	int2_data	int2_fast_offset	int2_fifo	int2_auto_offset
Bit	3	2	1	0
Read/Write	R/W	R/W	R/W	R/W
Reset Value	0	0	0	0
Content	Int1_auto_offset	int1_fifo	int1_fast_offset	int1_data

int2_data: map new data interrupt to INT4 pin: '0' → disabled, or '1' → enabled
 int2_fast_offset: map FastOffset interrupt to INT4 pin: '0' → disabled, or '1' → enabled
 int2_fifo: map Fifo interrupt to INT4 pin: '0' → disabled, or '1' → enabled
 int2_auto_offset: map AutoOffset tap interrupt to INT4 pin: '0' → disabled, or '1' → enabled
 int1_auto_offset: map AutoOffset tap interrupt to INT3 pin: '0' → disabled, or '1' → enabled
 int1_fifo: map Fifo interrupt to INT3 pin: '0' → disabled, or '1' → enabled
 int1_fast_offset: map FastOffset interrupt to INT3 pin: '0' → disabled, or '1' → enabled
 int1_data: map new data interrupt to INT3 pin: '0' → disabled, or '1' → enabled

GYR Register 0x19 (INT_MAP_2)

Controls which interrupt signals are mapped to the INT4 pin.

Name	0x19	INT_MAP_2		
Bit	7	6	5	4
Read/Write	R/W	R/W	R/W	R/W
Reset Value	0	0	0	0
Content	reserved			
Bit	3	2	1	0
Read/Write	R/W	R/W	R/W	R/W
Reset Value	0	0	0	0
Content	Int2_high	reserved	Int2_any	reserved

Int2_high: map high rate interrupt to INT4 pin: '0' → disabled, or '1' → enabled
 Int2_any: map Any-Motion to INT4 pin: '0' → disabled, or '1' → enabled
 reserved: write '0'

GYR Register 0x1A

Contains the data source definition of those interrupts with selectable data source.

Name	0x1A			
Bit	7	6	5	4
Read/Write	R/W	R/W	R/W	R/W
Reset Value	0	0	0	0
Content	reserved		slow_offset_unfilt	reserved
Bit	3	2	1	0
Read/Write	R/W	R/W	R/W	R/W
Reset Value	0	0	0	0
Content	high_unfilt_data	reserved	any_unfilt_data	reserved

slow_offset_unfilt: '1' ('0') selects unfiltered (filtered) data for slow offset compensation

high_unfilt_data: '1' ('0') selects unfiltered (filtered) data for high rate interrupt

any_unfilt_data: '1' ('0') selects unfiltered (filtered) data for any motion interrupt

reserved: write '0'

GYR Register 0x1B

Contains the data source definition of fast offset compensation and the any motion threshold.

Name	0x1B			
Bit	7	6	5	4
Read/Write	R/W	R/W	R/W	R/W
Reset Value	0	0	0	0
Content	fast_offset_unfilt	any_th <6:4>		
Bit	3	2	1	0
Read/Write	R/W	R/W	R/W	R/W
Reset Value	0	1	0	0
Content	any_th <3:0>			

fast_offset_unfilt: '1' ('0') selects unfiltered (filtered) data for fast offset compensation

any_th: any_th = (1 + any_th(register value)) * 16 LSB

The any_th scales with the range setting

GYR Register 0x1C

Name	0x1C			
Bit	7	6	5	4
Read/Write	R/W	R/W	R/W	R/W
Reset Value	1	0	1	0
Content	awake_dur <1:0>		any_dursample <1:0>	
Bit	3	2	1	0
Read/Write	R/W	R/W	R/W	R/W
Reset Value	0	0	0	0
Content	reserved	any_en_z	any_en_y	any_en_x

awake_dur: 0=8 samples, 1=16 samples, 2=32 samples, 3=64 samples

any_dursample: 0=4 samples, 1=8 samples, 2=12 samples, 3=16 samples

any_en_z: '1' ('0') enables (disables) any motion interrupt for z-axis

any_en_y: '1' ('0') enables (disables) any motion interrupt for y-axis

any_en_x: '1' ('0') enables (disables) any motion interrupt for z-axis

If one of the bits any_x/y/z is enabled, the any motion interrupt is enabled

reserved: write '0'

GYR Register 0x1D is reserved.
GYR Register 0x1E

Name	0x1E			
Bit	7	6	5	4
Read/Write	R/W	R/W	R/W	R/W
Reset Value	1	0	0	0
Content	fifo_wm_en	reserved		
Bit	3	2	1	0
Read/Write	R/W	R/W	R/W	R/W
Reset Value	1	0	0	0
Content	reserved			

fifo_wm_en: '1' ('0') enables (disables) fifo water mark level interrupt

reserved: write '0'

GYR Register 0x1F and 0x20 are reserved
GYR Register 0x21 (INT_RST_LATCH)

Contains the interrupt reset bit and the interrupt mode selection.

Name	0x21	INT_RST_LATCH		
Bit	7	6	5	4
Read/Write	W	R/W	R/W	R/W
Reset Value	0	0	0	0
Content	reset_int	offset_reset	reserved	latch_status_bit
Bit	3	2	1	0
Read/Write	R/W	R/W	R/W	R/W
Reset Value	0	0	0	0
Content	latch_int<3:0>			

reset_int: write '1' → clear any latched interrupts, or '0' → keep latched interrupts active

offset_reset: write '1' → resets internal interrupt status of each interrupt
 write '1' → resets the Offset value calculated with FastOffset, SlowOffset & AutoOffset

latch_int<3:0>: '0000b' → non-latched, '0001b' → temporary, 250 ms,
 '0010b' → temporary, 500 ms, '0011b' → temporary, 1 s,
 '0100b' → temporary, 2 s, '0101b' → temporary, 4 s,
 '0110b' → temporary, 8 s, '0111b' → latched,
 '1000b' → non-latched, '1001b' → temporary, 250 μs,
 '1010b' → temporary, 500 μs, '1011b' → temporary, 1 ms,
 '1100b' → temporary, 12.5 ms, '1101b' → temporary, 25 ms,
 '1110b' → temporary, 50 ms, '1111b' → latched

reserved: write '0'

GYR Register 0x22 (High_Th_x)

Contains the high rate threshold and high rate hysteresis setting for the x-axis

Name	0x22	High_Th_x		
Bit	7	6	5	4
Read/Write	R/W	R/W	R/W	R/W
Reset Value	0	0	0	0
Content	high_hy_x <1:0>	high_th_x <4:3>		

Bit	3	2	1	0
Read/Write	R/W	R/W	R/W	R/W
Reset Value	0	0	1	0
Content	high_th_x <2:0>			high_en_x

high_hy_x: $high_hy_x = (255 + 256 * high_hy_x(\text{register value})) * 4 \text{ LSB}$
 The high_hy_x scales with the range setting

high_th_x: $high_th_x = (255 + 256 * high_th_x(\text{register value})) * 4 \text{ LSB}$
 The high_th_x scales with the range setting

high_en_x: '1' ('0') enables (disables) high rate interrupt for x-axis

GYR Register 0x23 (High_Dur_x)

Contains high rate duration setting for the x-axis.

Name	0x23	High_Dur_x		
Bit	7	6	5	4
Read/Write	R/W	R/W	R/W	R/W
Reset Value	0	0	0	1
Content	high_dur_x <7:4>			
Bit	3	2	1	0
Read/Write	R/W	R/W	R/W	R/W
Reset Value	1	0	0	1
Content	high_dur_x <3:0>			

high_dur_x: $high_dur_time_x = (1 + high_dur_x(\text{register value})) * 2.5\text{ms}$

GYR Register 0x24 (High_Th_y)

Contains the high rate threshold and high rate hysteresis setting for the y-axis.

Name	0x24	High_Th_y		
Bit	7	6	5	4
Read/Write	R/W	R/W	R/W	R/W
Reset Value	0	0	0	0
Content	high_hy_y <1:0>		high_th_y <4:3>	

Bit	3	2	1	0
Read/Write	R/W	R/W	R/W	R/W
Reset Value	0	0	1	0
Content	high_th_y <2:0>			high_en_y

high_hy_y: $\text{high_hy_y} = (255 + 256 * \text{high_hy_y}(\text{register value})) * 4 \text{ LSB}$
 The high_hy_y scales with the range setting

high_th_y: $\text{high_th_x} = (255 + 256 * \text{high_th_y}(\text{register value})) * 4 \text{ LSB}$
 The high_th_y scales with the range setting

high_en_y: '1' ('0') enables (disables) high rate interrupt for y-axis

GYR Register 0x25 (High_Dur_y)

Contains high rate duration setting for the x-axis.

Name	0x25	High_Dur_y		
Bit	7	6	5	4
Read/Write	R/W	R/W	R/W	R/W
Reset Value	0	0	0	1
Content	high_dur_y <7:4>			
Bit	3	2	1	0
Read/Write	R/W	R/W	R/W	R/W
Reset Value	1	0	0	1
Content	high_dur_y <3:0>			

high_dur_y: $\text{high_dur_time_y} = (1 + \text{high_dur_y}(\text{register value})) * 2.5\text{ms}$

GYR Register 0x26 (High_Th_z)

Contains the high rate threshold and high rate hysteresis setting for the z-axis.

Name	0x26	High_Th_z		
Bit	7	6	5	4
Read/Write	R/W	R/W	R/W	R/W
Reset Value	0	0	0	0
Content	high_hy_z <1:0>	high_th_z <4:3>		

Bit	3	2	1	0
Read/Write	R/W	R/W	R/W	R/W
Reset Value	0	0	1	0
Content	high_th_z <2:0>			high_en_z

high_hy_z: $high_hy_z = (255 + 256 * high_hx_z(\text{register value})) * 4 \text{ LSB}$
 The high_hy_x scales with the range setting

high_th_z: $high_th_z = (255 + 256 * high_th_z(\text{register value})) * 4 \text{ LSB}$
 The high_th_z scales with the range setting

high_en_z: '1' ('0') enables (disables) high rate interrupt for z-axis

GYR Register 0x27 (High_Dur_z)

Contains high rate duration setting for the z-axis.

Name	0x27	High_dur_z		
Bit	7	6	5	4
Read/Write	R/W	R/W	R/W	R/W
Reset Value	0	0	0	1
Content	high_dur_z <7:4>			
Bit	3	2	1	0
Read/Write	R/W	R/W	R/W	R/W
Reset Value	1	0	0	1
Content	high_dur_z <3:0>			

high_dur_z: $high_dur_time_z = (1 + high_dur_z(\text{register value})) * 2.5\text{ms}$

GYR Register 0x28 to 0x30 are reserved

GYR Register 0x31 (SOC)

Contains the slow offset cancellation setting.

Name	0x31	SOC		
Bit	7	6	5	4
Read/Write	R/W	R/W	R/W	R/W
Reset Value	0	1	1	0
Content	Slow_offset_th<1:0>		Slow_offset_dur<2:1>	

Bit	3	2	1	0
Read/Write	R/W	R/W	R/W	R/W
Reset Value	0	0	0	0
Content	Slow_offset_dur <0>	slow_offset_en_z	slow_offset_en_y	slow_offset_en_x

Slow_offset_th: 0=0.1°/s, 1=0.2°/s, 2=0.5°/s, 3=1°/s

Slow_offset_dur: 0=40ms, 1=80ms, 2=160ms, 3=320ms, 4=640ms, 5=1280ms, 6 and 7=unused

slow_offset_en_z: '1' ('0') enables (disables) slow offset compensation for z-axis

slow_offset_en_y: '1' ('0') enables (disables) slow offset compensation for y-axis

slow_offset_en_x: '1' ('0') enables (disables) slow offset compensation for x-axis

GYR Register 0x32 (A_FOC)

Contains the fast offset cancellation setting.

Name	0x32	A_FOC		
Bit	7	6	5	4
Read/Write	R/W	R/W	R/W	R/W
Reset Value	1	1	0	0
Content	auto_offset_wordlength<1:0>		fast_offset_wordlength<1:0>	
Bit	3	2	1	0
Read/Write	R	R/W	R/W	R/W
Reset Value	0	0	0	0
Content	fast_offset_en	fast_offset_en_z	fast_offset_en_y	fast_offset_en_x

auto_offset_wordlength: 0=32 samples, 1=64 samples, 2=128 samples, 3=256 samples

fast_offset_wordlength: 0=32 samples, 1=64 samples, 2=128 samples, 3=256 samples

fast_offset_en: write '1' → triggers the fast offset compensation for the enabled axes

fast_offset_en_z: '1' ('0') enables (disables) fast offset compensation for z-axis

fast_offset_en_y: '1' ('0') enables (disables) fast offset compensation for y-axis

fast_offset_en_x: '1' ('0') enables (disables) fast offset compensation for x-axis

GYR Register 0x33 (TRIM_NVM_CTRL)

Contains the control settings for the few-time programmable non-volatile memory (NVM).

Name	0x33	TRIM_NVM_CTRL		
Bit	7	6	5	4
Read/Write	R	R	R	R
Reset Value	n/a	n/a	n/a	n/a
Content	nvm_remain<3:0>			
Bit	3	2	1	0
Read/Write	R/W	R	W	R/W
Reset Value	0	n/a	0	0
Content	nvm_load	nvm_rdy	nvm_prog_trig	nvm_prog_mode

nvm_remain<3:0>: number of remaining write cycles permitted for NVM; the number is decremented each time a write to the NVM is triggered

nvm_load: '1' → trigger, or '0' → do not trigger an update of all configuration registers from NVM; the nvm_rdy flag must be '1' prior to triggering the update

nvm_rdy: status of NVM controller: '0' → NVM write / NVM update operation is in progress, '1' → NVM is ready to accept a new write or update trigger

nvm_prog_trig: '1' → trigger, or '0' → do not trigger an NVM write operation; the trigger is only accepted if the NVM was unlocked before and nvm_remain<3:0> is greater than '0'; flag nvm_rdy must be '1' prior to triggering the write cycle

nvm_prog_mode: '1' → unlock, or '0' → lock NVM write operation

GYR Register 0x34 (BGW_SPI3_WDT)

Contains settings for the digital interfaces.

Name	0x34	BGW_SPI3_WDT		
Bit	7	6	5	4
Read/Write	R/W	R/W	R/W	R/W
Reset Value	0	0	0	0
Content	reserved		ext_fifo_s_en	ext_fifo_s_sel
Bit	3	2	1	0
Read/Write	R/W	R/W	R/W	R/W
Reset Value	0	0	0	0
Content	reserved	i2c_wdt_en	i2c_wdt_sel	spi3

ext_fifo_s_en:	enables external FIFO synchronization mode, '1' → enable, '0' → disable
ext_fifo_s_sel:	selects source for external FIFO synchronization '1' → source = INT4 '0' → source = INT3
reserved:	write '0'
i2c_wdt_en:	if I ² C interface mode is selected then '1' → enable, or '0' → disables the watchdog at the SDI pin (= SDA for I ² C)
i2c_wdt_sel:	select an I ² C watchdog timer period of '0' → 1 ms, or '1' → 50 ms
spi3:	select '0' → 4-wire SPI, or '1' → 3-wire SPI mode

GYR Register 0x35 is reserved

GYR Register 0x36 (OFC1)

Contains offset compensation values.

Name	0x36	OFC1		
Bit	7	6	5	4
Read/Write	R/W	R/W	R/W	R/W
Reset Value	0	0	0	0
Content	offset_x<3:2>		offset_y<3:2>	
Bit	3	2	1	0
Read/Write	R/W	R/W	R/W	R/W
Reset Value	0	0	0	0
Content	offset_y<1>	offset_z<3:1>		

offset_x<3:2>:	setting of offset calibration values X-channel
offset_y<3:1>:	setting of offset calibration values Y-channel
offset_z<3:1>:	setting of offset calibration values Z-channel

GYR Register 0x37 (OFC2)

Contains offset compensation values for X-channel.

Name	0x37	OFC2		
Bit	7	6	5	4
Read/Write	R/W	R/W	R/W	R/W
Reset Value	0	0	0	0
Content	offset_x<11:8>			

Bit	3	2	1	0
Read/Write	R/W	R/W	R/W	R/W
Reset Value	0	0	0	0
Content	offset_x<7:4>			

offset_x <11:4>: offset value, which is subtracted from the internal filtered and unfiltered x-axis data; please refer to the following table for the scaling of the offset register; the content of the offset_x<11:4> may be written to the NVM; it is automatically restored from the NVM after each power-on or softreset; offset_x<11:4> may be written directly by the user.

Example:

Original readout value	Value in offset register	Compensated readout value
0 °/s	2047	-124.94 °/s
0 °/s	0	0 g
0 °/s	-2048	125 °/s

GYR Register 0x38 (OFC3)

Contains offset compensation values for Y-channel.

Name	0x38	OFC3		
Bit	7	6	5	4
Read/Write	R/W	R/W	R/W	R/W
Reset Value	0	0	0	0
Content	offset_y<11:8>			
Bit	3	2	1	0
Read/Write	R/W	R/W	R/W	R/W
Reset Value	0	0	0	0
Content	offset_y<7:4>			

offset_y <11:4>: offset value, which is subtracted from the internal filtered and unfiltered y-axis data; please refer to the above (see OFC2) table for the scaling of the offset register; the content of the offset_y<11:4> may be written to the NVM; it is automatically restored from the NVM after each power-on or softreset; offset_y<11:4> may be written directly by the user.

For reference see example at GYR Register 0x38 (OFC2)

GYR Register 0x39 (OFC4)

Contains offset compensation values for Z-channel.

Name	0x39	OFC4		
Bit	7	6	5	4
Read/Write	R/W	R/W	R/W	R/W
Reset Value	0	0	0	0
Content	offset_z<11:8>			
Bit	3	2	1	0
Read/Write	R/W	R/W	R/W	R/W
Reset Value	0	0	0	0
Content	offset_z<7:4>			

offset_z <11:4>: offset value, which is subtracted from the internal filtered and unfiltered z-axis data; please refer to the above table (see OFC2) for the scaling of the offset register; the content of the offset_z<11:4> may be written to the NVM; it is automatically restored from the NVM after each power-on or softreset; offset_z<11:4> may be written directly by the user.

For reference see example at GYR Register 0x38 (OFC2)

GYR Register 0x3A (TRIM_GP0)

Contains general purpose data register with NVM back-up.

Name	0x3A	TRIM_GP0		
Bit	7	6	5	4
Read/Write	R/W	R/W	R/W	R/W
Reset Value	X	X	X	X
Content	GP0<3:0>			
Bit	3	2	1	0
Read/Write	R/W	R/W	R/W	R/W
Reset Value	X	X	X	X
Content	offset_x<1:0>		offset_y<0>	offset_z<0>

GP0<3:0>: general purpose NVM image register not linked to any sensor-specific functionality; register may be written to NVM and is restored after each power-up or software reset

offset_x<1:0>: setting of offset calibration values X-channel

offset_y<0>: setting of offset calibration values Y-channel

offset_z<0>: setting of offset calibration values Z-channel

GYR Register 0x3B (TRIM_GP1)

Contains general purpose data register with NVM back-up.

Name	0x3B	TRIM_GP1		
Bit	7	6	5	4
Read/Write	R/W	R/W	R/W	R/W
Reset Value	X	X	X	X
Content	GP1<7:4>			
Bit	3	2	1	0
Read/Write	R/W	R/W	R/W	R/W
Reset Value	X	X	X	X
Content	GP1<3:0>			

GP1<7:0>: general purpose NVM image register not linked to any sensor-specific functionality; register may be written to NVM and is restored after each power-up or software reset

GYR Register 0x3C (BIST)

Contains Built in Self-Test (BIST) possibilities:

Name	0x3C	BIST		
Bit	7	6	5	4
Read/Write	R/W	R/W	R/W	R
Reset Value	0	0	0	0
Content	reserved	reserved	reserved	rate_ok
Bit	3	2	1	0
Read/Write	R/W	R	R	W
Reset Value	0	0	0	0
Content	reserved	bist_fail	bist_rdy	trig_bist

Rate ok: '1' indicates proper sensor function, no trigger is needed for this

Trig_bist: write '1' in order to perform the bist test

Bist_rdy: if bist_rdy is '1' and bist_fail is '0' result of bist test is ok means "sensor ok"
 If bist_rdy is '1' and bist_fail is '1' result of bist test is not ok means "sensor values not in expected range"

GYR Register 0x3D (FIFO_CONFIG_0)

Contains the FIFO watermark level.

Name	0x3D	FIFO_CONFIG_0		
Bit	7	6	5	4
Read/Write	R/W	R/W	R/W	R/W
Reset Value	n/a	n/a	0	0
Content	tag	fifo_water_mark_level_trigger_retain<6:4>		
Bit	3	2	1	0
Read/Write	R/W	R/W	R/W	R/W
Reset Value	0	0	0	0
Content	fifo_water_mark_level_trigger_retain<3:0>			

tag: '1' ('0') enables (disables) fifo tag (interrupt)

Address: 0x3D bit 7	tag	Interrupt data stored in FIFO
'0' (Default)		Do not collect Interrupts
'1'		collect Interrupts

fifo_water_mark_level_trigger_retain<6:0>:

fifo_water_mark_level_trigger_retain<6:0> defines the FIFO watermark level.
 An interrupt will be generated, when the number of entries in the FIFO exceeds fifo_water_mark_level_trigger_retain<6:0>;

GYR Register 0x3E (FIFO_CONFIG_1)

Contains FIFO configuration settings. The FIFO buffer memory is cleared and the fifo-full flag is cleared when writing to FIFO_CONFIG_1 register.

Name	0x3E	FIFO_CONFIG_1		
Bit	7	6	5	4
Read/Write	R/W	R/W	R/W	R/W
Reset Value	0	0	0	0
Content	fifo_mode<1:0>		Reserved	
Bit	3	2	1	0
Read/Write	R/W	R/W	R/W	R/W
Reset Value	0	0	0	0
Content	Reserved		fifo_data_select<1:0>	



fifo_mode<1:0>: selects the FIFO operating mode:
 '00b' → BYPASS (buffer depth of 1 frame; old data is discarded),
 '01b' → FIFO (data collection stops when buffer is filled with 100 frames),
 '10b' → STREAM (sampling continues when buffer is full; old is discarded),
 '11b' → reserved, do not use

fifo_data_select<1:0>:

Address: 0x3E bits<1:0> data_select	data of axis stored in FIFO
'00' (Default)	X,Y,Z
'01'	X only
'10'	Y only
'11'	Z only

reserved: write '0'

GYR Register 0x3F (FIFO_DATA)

FIFO data readout register. The format of the LSB and MSB components corresponds to that of the angular rate data readout registers. Read burst access may be used since the address counter will not increment when the read burst is started at the address of FIFO_DATA. The entire frame is discarded when a frame is only partially read out.

Name	0x3F	FIFO_DATA		
Bit	7	6	5	4
Read/Write	R	R	R	R
Reset Value	n/a	n/a	n/a	n/a
Content	fifo_data_output_register<7:4>			
Bit	3	2	1	0
Read/Write	R	R	R	R
Reset Value	n/a	n/a	n/a	n/a
Content	fifo_data_output_register<3:0>			

fifo_data_output_register<7:0>:

FIFO data readout; data format depends on the setting of register fifo_data_select<1:0>:

if X+Y+Z data are selected, the data of frame n is reading out in the order of X-lsb(n), X-msb(n), Y-lsb(n), Y-msb(n), Z-lsb(n), Z-msb(n);
 if X-only is selected, the data of frame n and n+1 are reading out in the order of X-lsb(n), X-msb(n), X-lsb(n+1), X-msb(n+1); the Y-only and Z-only modes behave analogously

9. Digital interface of the device

The BMI055 supports two serial digital interface protocols for communication as a slave with a host device: SPI (4-wire and 3-wire) and I²C. The active interface is selected by the state of the Pin#07 (PS) 'protocol select' pin: 'GND' ('VDDIO') selects SPI (I²C). For details please refer to section 11.

By default, SPI operates in the standard 4-wire configuration. It can be re-configured by software to work in 3-wire mode instead of standard 4-wire mode.

Both digital interfaces share partly the same pins. Additionally each inertial sensor (accelerometer and gyroscope) provides specific interface pins which allow the user to operate the inertial sensors independently of each other. The mapping for each interface and each inertial sensor is given in the following table:

Table 28: Mapping of the interface pins

Pin#	Name	use w/ SPI	use w/ I ² C	Description
15	SDO1	SDO1	address	SPI: Accel Data Output (4-wire mode) I ² C: Used to set LSB of Accel I ² C address
10	SDO2	SDO2	address	SPI: Gyro Data Output (4-wire mode) I ² C: Used to set LSB of Gyro I ² C address
9	SDx	SDI	SDA	SPI: Data In (4-wire mode) & Data In/Out (3-wire mode) I ² C: Serial Data
14	CSB 1	CSB1	unused	SPI: Accel Chip Select (enable)
5	CSB2	CSB2	unused	SPI: Gyro Chip Select (enable)
8	SCx	SCK	SCL	SPI: Serial Clock SCK I ² C: Serial Clock SCL

The following table shows the electrical specifications of the interface pins:

Table 29: Electrical specification of the interface pins

Parameter	Symbol	Condition	Min	Typ	Max	Units
Pull-up Resistance, CSB pin	R _{up}	Internal Pull-up Resistance to VDDIO	75	100	125	kΩ
Input Capacitance	C _{in}			5	10	pF
I ² C Bus Load Capacitance (max. drive capability)	C _{I2C_Load}				400	pF

9.1 Serial peripheral interface (SPI)

The timing specification for SPI of the BMI055 is given in the following table:

Table 30: SPI timing

Parameter	Symbol	Condition	Min	Max	Units
Clock Frequency	f_{SPI}	Max. Load on SDI or SDO = 25pF, $V_{\text{DDIO}} \geq 1.62\text{V}$		10	MHz
		$V_{\text{DDIO}} < 1.62\text{V}$		7.5	MHz
SCK Low Pulse	t_{SCKL}		20		ns
SCK High Pulse	t_{SCKH}		20		ns
SDI Setup Time	$t_{\text{SDI setup}}$		20		ns
SDI Hold Time	$t_{\text{SDI hold}}$		20		ns
SDO Output Delay	$t_{\text{SDO_OD}}$	Load = 25pF, $V_{\text{DDIO}} \geq 1.62\text{V}$		30	ns
		Load = 25pF, $V_{\text{DDIO}} < 1.62\text{V}$		50	ns
		Load = 250pF, $V_{\text{DDIO}} > 2.4\text{V}$		40	ns
CSB Setup Time	$t_{\text{CSB setup}}$		20		ns
CSB Hold Time	$t_{\text{CSB hold}}$		40		ns
Idle time between write accesses, normal mode, standby mode, low-power mode 2	$t_{\text{IDLE_wacc_nm}}$		2		μs
Idle time between write accesses, suspend mode, low-power mode 1	$t_{\text{IDLE_wacc_sum}}$		450		μs

The following figure shows the definition of the SPI timings:

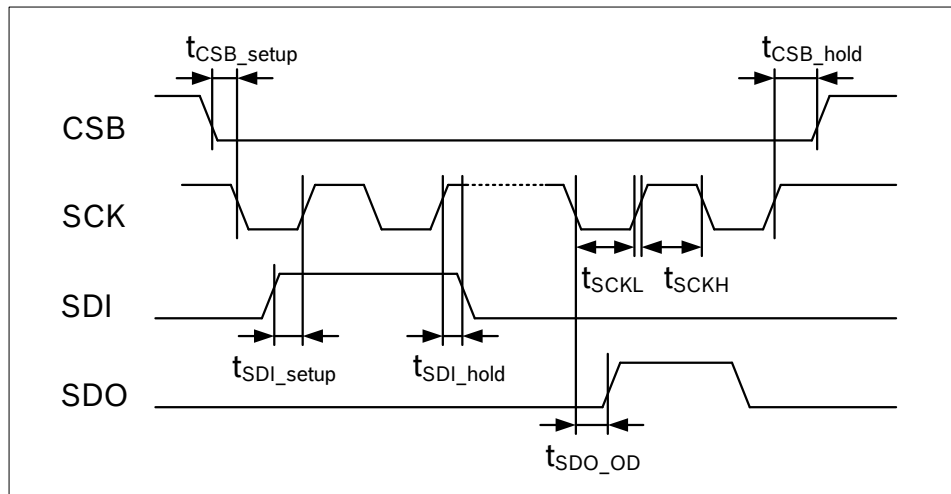

Figure 20: SPI timing diagram

The SPI interface of the BMI055 is compatible with two modes, '00' and '11'. The automatic selection between [CPOL = '0' and CPHA = '0'] and [CPOL = '1' and CPHA = '1'] is controlled based on the value of SCK after a falling edge of CSB (1 or 2).

Two configurations of the SPI interface are supported by the BMI055: 4-wire and 3-wire. The same protocol is used by both configurations. The device operates in 4-wire configuration by default. It can be switched to 3-wire configuration by writing '1' to (ACC 0x34) *spi3* and to (GYR 0x34) *spi3*. Pin SDI is used as the common data pin in 3-wire configuration.

For single byte read as well as write operations, 16-bit protocols are used. The BMI055 also supports multiple-byte read operations.

In SPI 4-wire configuration CSB (1 or 2 – chip select low active), SCK (serial clock), SDI (serial data input), and SDO (1 or 2 – serial data output) pins are used. The communication starts when the CSB (1 or 2) is pulled low by the SPI master and stops when CSB (1 or 2) is pulled high. SCK is also controlled by SPI master. SDI and SDO (1 or 2) are driven at the falling edge of SCK and should be captured at the rising edge of SCK.

The basic write operation waveform for 4-wire configuration is depicted in figure 21. During the entire write cycle SDO remains in high-impedance state.

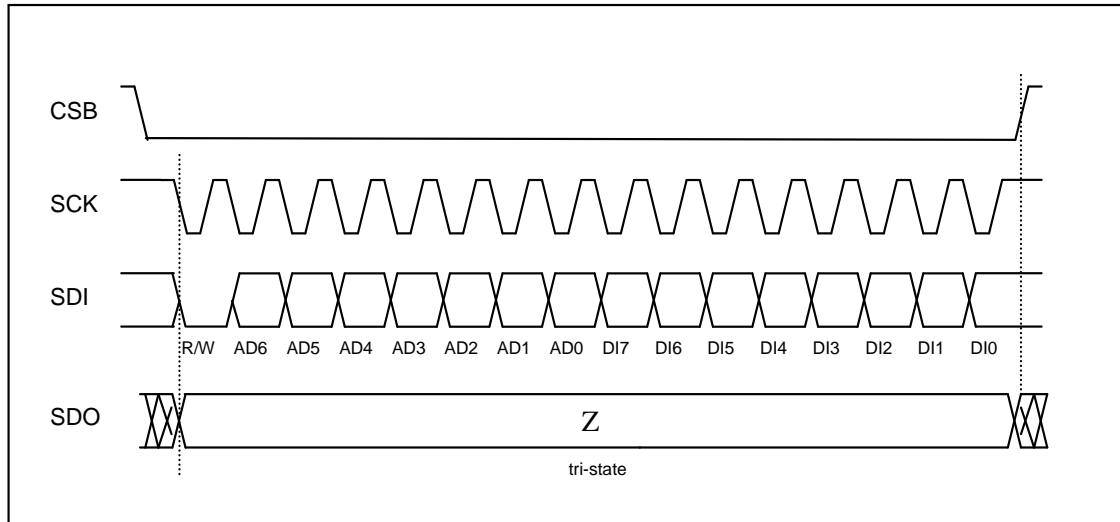

Figure 21: 4-wire basic SPI write sequence (mode '11')

The basic read operation waveform for 4-wire configuration is depicted in figure 22:

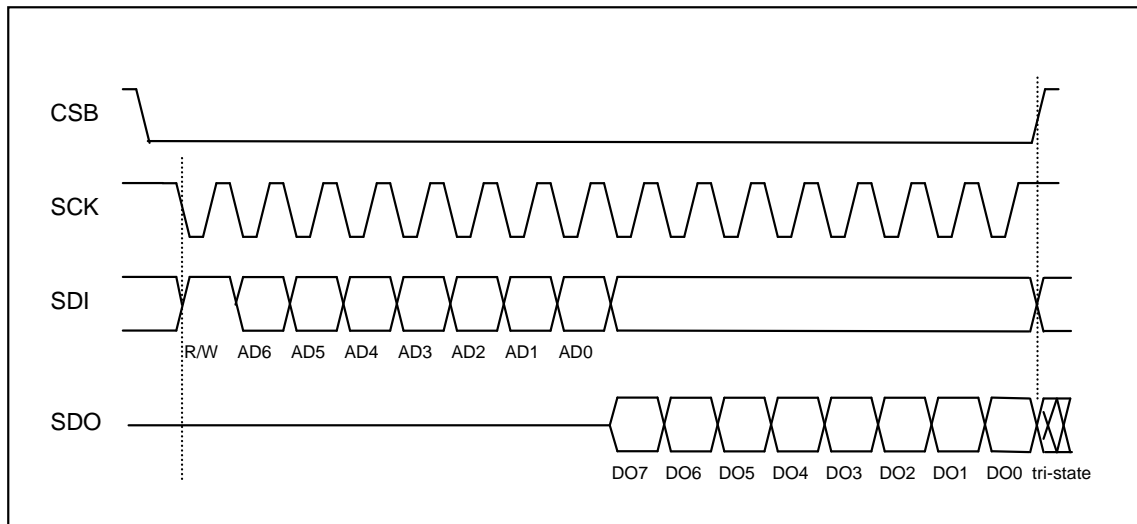

Figure 22: 4-wire basic SPI read sequence (mode '11')

The data bits are used as follows:

Bit0: Read/Write bit. When 0, the data SDI is written into the chip. When 1, the data SDO from the chip is read.

Bit1-7: Address AD(6:0).

Bit8-15: when in write mode, these are the data SDI, which will be written into the address. When in read mode, these are the data SDO, which are read from the address.

Multiple read operations are possible by keeping CSB low and continuing the data transfer. Only the first register address has to be written. Addresses are automatically incremented after each read access as long as CSB stays active low.

The principle of multiple read is shown in figure 23:

Start	Control byte								Data byte								Data byte								Data byte								Stop																	
	RW	Register address (02h)							Data register - address 02h								Data register - address 03h								Data register - address 04h																									
CSB = 0	1	0	0	0	0	0	1	0	X	X	X	X	X	X	X	X	X	X	X	X	X	X	X	X	X	X	X	X	X	X	X	X	X	X	X	X	X	X	X	X	X	X	X	X	X	X	X	X	X	CSB = 1

Figure 23: SPI multiple read

In SPI 3-wire configuration CSB (1 or 2 – chip select low active), SCK (serial clock), and SDI (serial data input and output) pins are used. The communication starts when the CSB is pulled low by the SPI master and stops when CSB is pulled high. SCK is also controlled by SPI master. SDI is driven (when used as input of the device) at the falling edge of SCK and should be captured (when used as the output of the device) at the rising edge of SCK.

The protocol as such is the same in 3-wire configuration as it is in 4-wire configuration. The basic operation wave-form (read or write access) for 3-wire configuration is depicted in figure 24:

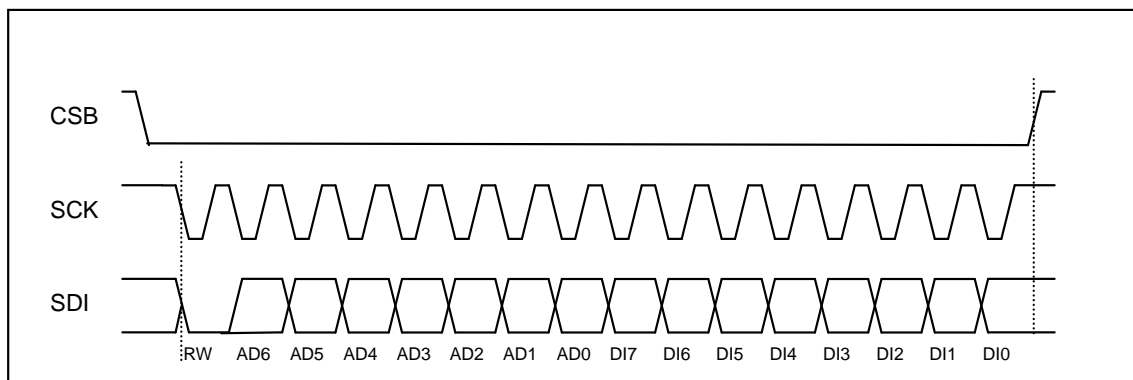

Figure 24: 3-wire basic SPI read or write sequence (mode '11')

9.2 Inter-Integrated Circuit (I²C)

The I²C bus uses SCL (= SCx pin, serial clock) and SDA (= SDx pin, serial data input and output) signal lines. Both lines are connected to V_{DDIO} externally via pull-up resistors so that they are pulled high when the bus is free.

The I²C interface of the BMI055 is compatible with the I²C Specification UM10204 Rev. 03 (19 June 2007), available at <http://www.nxp.com>. The BMI055 supports I²C standard mode and fast mode, only 7-bit address mode is supported. For V_{DDIO} = 1.2V to 1.8V the guaranteed voltage output levels are slightly relaxed as described in the Parameter Specification (table 1).

The default I²C address of the accelerometer device is 0011000b (0x18) and of the gyro device is 1101000b (0x68). It is used if the SDO (1 and 2) pin is pulled to 'GND'. The alternative accel address 0011001b (0x19) and/or the alternative gyro address 1101001b (0x69) is selected by pulling the SDO (1 and/or 2) pin to 'V_{DDIO}'.

The timing specification for I²C of the BMI055 is given in table 31:

Table 31: I²C timings

Parameter	Symbol	Condition	Min	Max	Units
Clock Frequency	f _{SCL}			400	kHz
SCL Low Period	t _{LOW}		1.3		μs
SCL High Period	t _{HIGH}		0.6		
SDA Setup Time	t _{SUDAT}		0.1		
SDA Hold Time	t _{HDDAT}		0.0		
Setup Time for a repeated Start Condition	t _{SUSTA}		0.6		
Hold Time for a Start Condition	t _{HDSTA}		0.6		
Setup Time for a Stop Condition	t _{SUSTO}		0.6		
Time before a new Transmission can start	t _{BUF}		1.3		
Idle time between write accesses, normal mode, standby mode, low-power mode 2	t _{IDLE wacc n m}		2		μs
Idle time between write accesses, suspend mode, low-power mode 1	t _{IDLE wacc s um}		450		μs

Figure 25 shows the definition of the I²C timings given in table 31:

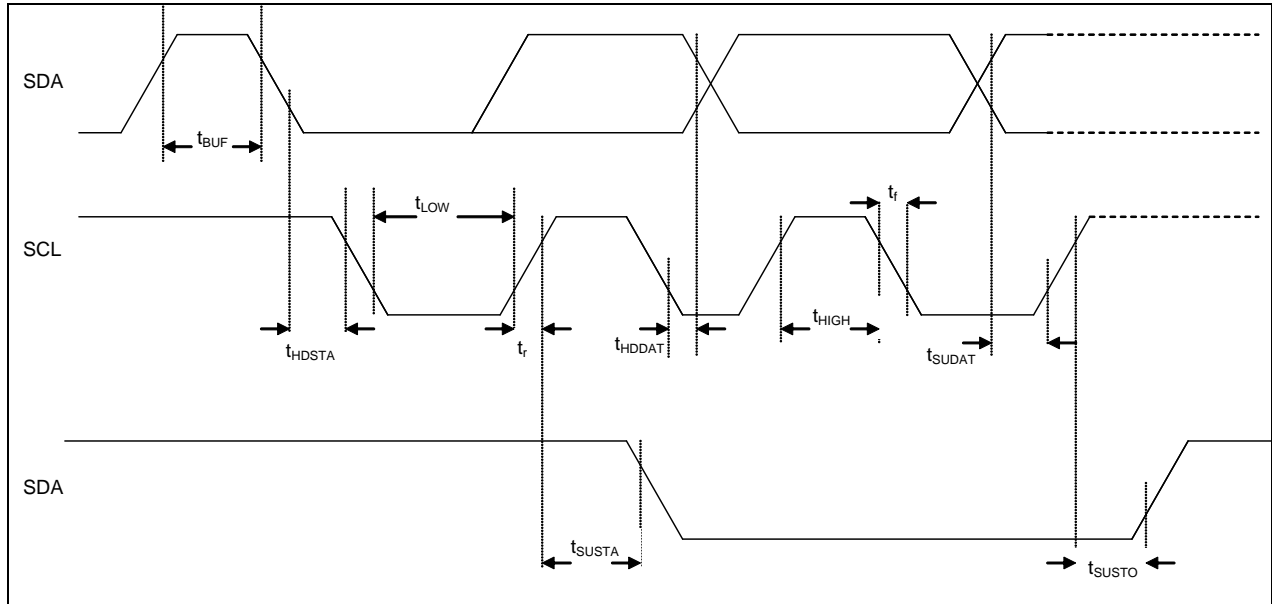

Figure 25: I²C timing diagram

The I²C protocol works as follows:

START: Data transmission on the bus begins with a high to low transition on the SDA line while SCL is held high (start condition (S) indicated by I²C bus master). Once the START signal is transferred by the master, the bus is considered busy.

STOP: Each data transfer should be terminated by a Stop signal (P) generated by master. The STOP condition is a low to HIGH transition on SDA line while SCL is held high.

ACK: Each byte of data transferred must be acknowledged. It is indicated by an acknowledge bit sent by the receiver. The transmitter must release the SDA line (no pull down) during the acknowledge pulse while the receiver must then pull the SDA line low so that it remains stable low during the high period of the acknowledge clock cycle.

In the following diagrams these abbreviations are used:

S	Start
P	Stop
ACKS	Acknowledge by slave
ACKM	Acknowledge by master
NACKM	Not acknowledge by master
RW	Read / Write

A START immediately followed by a STOP (without SCL toggling from 'VDDIO' to 'GND') is not supported. If such a combination occurs, the STOP is not recognized by the device.

I²C write access:

I²C write access can be used to write a data byte in one sequence.

The sequence begins with start condition generated by the master, followed by 7 bits slave address and a write bit (RW = 0). The slave sends an acknowledge bit (ACK = 0) and releases the bus. Then the master sends the one byte register address. The slave again acknowledges the transmission and waits for the 8 bits of data which shall be written to the specified register address. After the slave acknowledges the data byte, the master generates a stop signal and terminates the writing protocol.

Example of an I²C write access to the accelerometer:

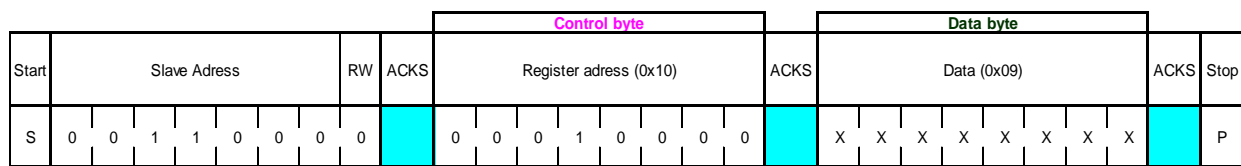

Figure 26: I²C write

I²C read access:

I²C read access also can be used to read one or multiple data bytes in one sequence.

A read sequence consists of a one-byte I²C write phase followed by the I²C read phase. The two parts of the transmission must be separated by a repeated start condition (Sr). The I²C write phase addresses the slave and sends the register address to be read. After slave acknowledges the transmission, the master generates again a start condition and sends the slave address together with a read bit (RW = 1). Then the master releases the bus and waits for the data bytes to be read out from slave. After each data byte the master has to generate an acknowledge bit (ACK = 0) to enable further data transfer. A NACKM (ACK = 1) from the master stops the data being transferred from the slave. The slave releases the bus so that the master can generate a STOP condition and terminate the transmission.

The register address is automatically incremented and, therefore, more than one byte can be sequentially read out. Once a new data read transmission starts, the start address will be set to the register address specified in the latest I²C write command. By default the start address is set at 0x00. In this way repetitive multi-bytes reads from the same starting address are possible.

In order to prevent the I²C slave of the device to lock-up the I²C bus, a watchdog timer (WDT) is implemented. The WDT observes internal I²C signals and resets the I²C interface if the bus is locked-up by the BMI055. The activity and the timer period of the WDT can be configured through the bits (ACC 0x34) plus (GYR 0x34) *i2c_wdt_en* and (ACC 0x34) plus (GYR 0x34) *i2c_wdt_sel*.

Writing '1' ('0') to (ACC 0x34) *i2c_wdt_en* plus (GYR 0x34) *i2c_wdt_en* activates (de-activates) the WDT. Writing '0' ('1') to (ACC 0x34) *i2c_wdt_en* plus (GYR 0x34) *i2c_wdt_sel* selects a timer period of 1 ms (50 ms).

Example of an I²C read access to the accelerometer:

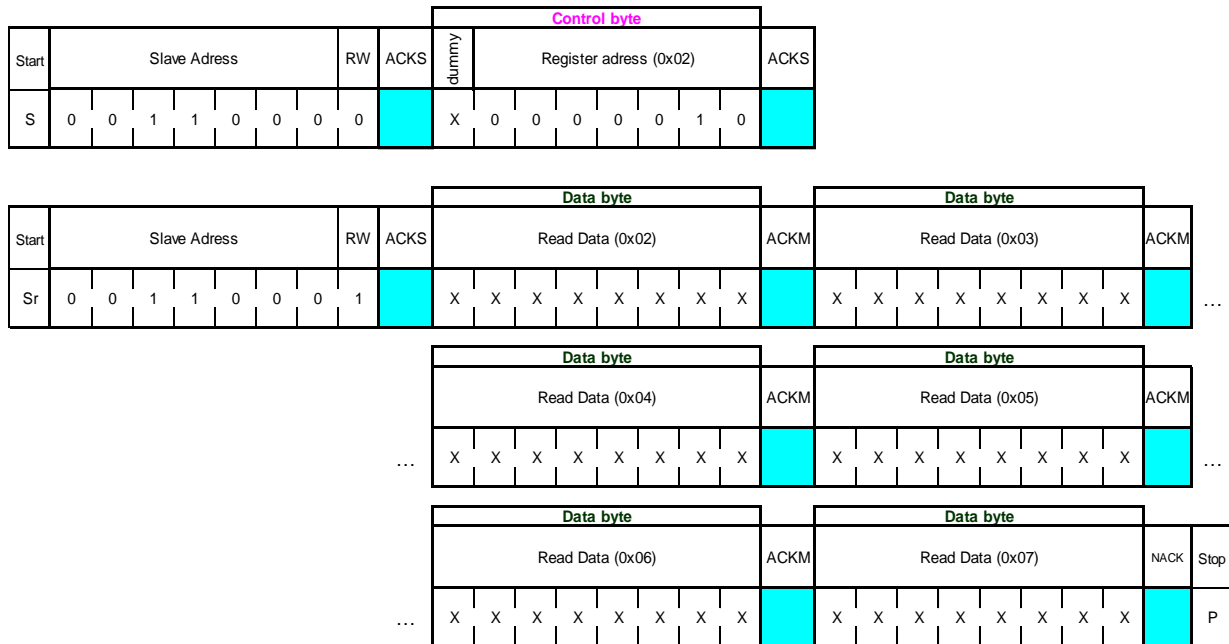

Figure 27: I²C multiple read

9.2.1 SPI and I²C Access Restrictions

In order to allow for the correct internal synchronisation of data written to the BMI055, certain access restrictions apply for consecutive write accesses or a write/read sequence through the SPI as well as I²C interface. The required waiting period depends on whether the device is operating in normal mode or other modes according to chapters 5.1 and 7.1.

As illustrated in figure 28, an interface idle time of at least 2µs is required following a write operation when the device operates in normal mode. In suspend mode an interface idle time of at least 450µs is required.

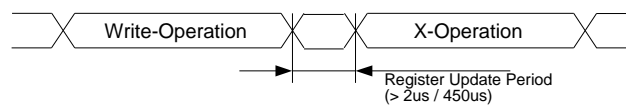

Figure 28: Post-Write Access Timing Constraints

10. FIFO Operation

10.1 FIFO Operating Modes

The BMI055 features 2 integrated FIFO memories capable of storing up to 32 frames of accelerometer data and 100 frames of gyro data in FIFO mode. Conceptually each frame consists of three 16 bit words corresponding to the x, y and z- axis of the accelerometer and the gyro, which are sampled at the same point in time. The FIFO is a buffer memory, which can be configured to operate in the following modes:

- FIFO Mode:** In FIFO mode the X, Y and Z acceleration- and rate data of the selected axes and sensors are stored in the buffer memory. If enabled, a watermark interrupt is triggered when the buffer has filled up to a configurable level. The buffer will be continuously filled until the fill level reaches 32 frames for the accelerometer and 100 frames for the gyroscope. When it is full the data collection is stopped, and all additional samples are ignored. Once the buffer is full, a FIFO-full interrupt is generated if it has been enabled.
- STREAM Mode:** In STREAM mode the X, Y and Z acceleration- and rate data of the selected axes are stored in the buffer until it is full. The buffer has a depth of 31 frames of accelerometer data and 99 frames of gyro data. When the buffer is full the data collection continues and oldest entry is discarded. If enabled, a watermark interrupt is triggered when the buffer is filled to a configurable level. Once the buffer is full, a FIFO-full interrupt is generated if it has been enabled.
- BYPASS Mode:** In bypass mode, only the current sensor data can be read out from the FIFO address. Essentially, the FIFO behaves like the STREAM mode with a depth of 1. Compared to reading the data from the normal data registers, the advantage to the user is that the packages X, Y, Z are from the same timestamp, while the data registers are updated sequentially and hence mixing of data from different axes can occur.

The primary FIFO operating mode is selected with register (*ACC 0x3E*) <7:6> and (*GYR 0x0E*) <7:6> according to table 32. When reading register (*ACC 0x3E*) <7:6> and (*GYR 0x0E*) <7:6> the current operating mode is given. Writing to (*ACC 0x3E*) <7:6> and (*GYR 0x0E*) <7:6> clears and resets the buffer and resets the FIFO-full and watermark interrupt.

Address: 0x3E bits<7:6> mode<1:0>	FIFO Mode	Function
'00' (Default)	BYPASS	buffer depth of 1 frame; old data are discarded
'01'	FIFO	data collection stops when buffer is full
'10'	STREAM	when buffer full: sampling continues, old data discarded
'11'	Reserved	

Table 32: FIFO operating mode selection

10.2 FIFO Data Readout

The FIFO stores the data that are also available at the read-out registers (*ACC 0x02*) to (*ACC 0x07*) for the accelerometer and/or (*GYR 0x02*) to (*GYR 0x07*) for the gyroscope. Thus, all configuration settings apply to the FIFO data as well as the data readout registers. The FIFO read out is possible through register (*ACC 0x3F*) bits <7:0> and/or (*GYR 0x3F*) bits <7:0>. The readout can be performed using burst mode since the read address counter is no longer incremented, when it has reached address (*0x3F*). This implies that the trapping also occurs when the burst read access starts below address (*0x3F*). A single burst can read out one or more frames at a time. If a frame is not read completely due to an incomplete read operation, the remaining part of the frame is lost. In this case the FIFO aligns to the next frame during the next read operation. The address (*ACC 0x3E*) bits<1:0> (*data_select*) or (*GYR 0x3E*) bits<1:0> (*data_select*) allows the user to select the data stored in the FIFO according to table 33. Writing to *data_select*<1:0> clears the FIFO buffer.

Address: ACC 0x3E and GYR 0x3E bits<1:0> <i>data_select</i>	data of axis stored in FIFO
'00' (Default)	X,Y,Z (plus INT_status0,1 for GYRO)
'01'	X only
'10'	Y only
'11'	Z only
Address: GYR 0x3D bit 7 tag	Interrupt data stored in FIFO
'0' (Default)	Do not collect Interrupts for Gyro
'1'	Collect Interrupts for Gyro

Table 33: FIFO data selection

10.2.1 Data readout Accelerometer

If all axes and tag are enabled, the format of the data read-out from (*ACC 0x3F*) *fifo_data*<7:0> is as follows:

If all axes are enabled, the format of the data read-out from (*ACC 0x3F*) is as follows:

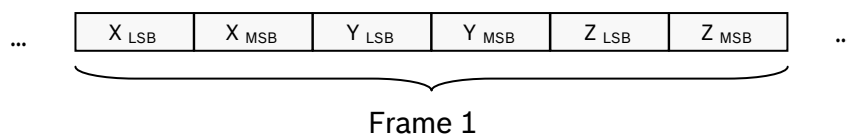

If only one axis is enabled, the format of the data read-out from (*ACC 0x3F*) is as follows (example shown: y-axis only, other axes are equivalent).

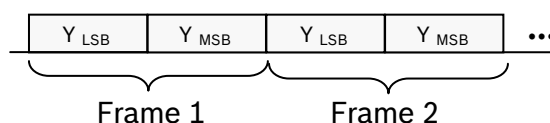

If a frame is not completely read due to an incomplete read operation, the remaining part of the frame is discarded. In this case the FIFO aligns to the next frame during the next read operation. In order for the discarding mechanism to operate correctly, there must be a delay of at least 1.5 μs between the last data bit of the partially read frame and the first address bit of the next FIFO read access. Otherwise frames must not be read out partially.

If the FIFO is read beyond the FIFO fill level zeroes (0) will be read. If the FIFO is read beyond the FIFO fill level the read or burst read access time must not exceed the sampling time t_{SAMPLE} . Otherwise frames may be lost.

10.2.2 Data readout Gyroscope

If all axes and tag are enabled, the format of the data read-out from (*GYR 0x3F*) `fifo_data<7:0>` is as follows:

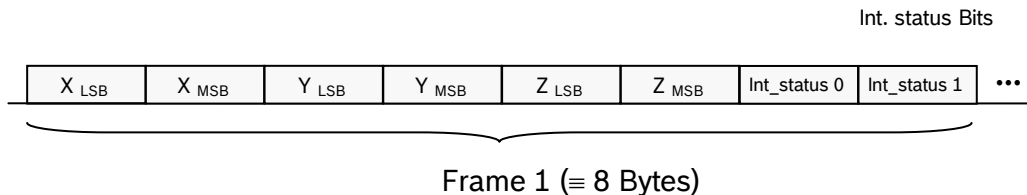

If only one axis is enabled (and tag is disabled), the format of the data read-out from register `fifo_data<7:0>` is as follows (example shown: Y-axis only, other axis are equivalent). The buffer depth of the FIFO is independent of the fact whether all or a single axis have been selected.

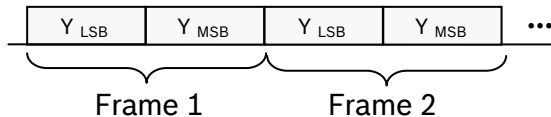

10.2.3 External FIFO synchronization (EFS) for the gyroscope

In addition to the explained data format for the angular rate and interrupt data, the FIFO of the gyroscope features a mode that allows the precise synchronization of external event with the gyroscope angular rate and gyroscope interrupts saved in the internal FIFO. This synchronization can be used for example for image and video stabilization applications. The EFS Mode can be used in the operating modes FIFO-Mode and STREAM-Mode but not in BYPASS-Mode.

In order to use the EFS capability, any of the gyroscope interrupt pins (INT3 or INT4) can be reconfigured to act as EFS-pin, but not both. In addition, the EFS-Mode has to be enabled. The so configured interrupt pin will then behave as an input pin and not as an interrupt pin. The working principle is shown in below figure:



Timing diagram for external FIFO synchronization. EFS-pin is the Interrupt pin configured as EFS-Mode. FIFO z(0) is the least significant bit of the z-axis gyro data stored in the FIFO.

In order to enable the EFS-Mode the register (*GYR 0x34*) bit<5> must be set to “1”. To select the INT4 pin as EFS-pin, set the register (*GYR 0x34*) bit<4> to “1”. To select the INT3 pin as EFS-pin, set the register (*GYR 0x34*) bit<4> to “0”.

In this Mode, the least significant bit of the z-axis is used as tag-bit, therefore losing its meaning as gyroscope data bit. The remaining 15 bits of the z-axis gyroscope data keep the same meaning as in standard mode.

Once the EFS-pin is set to high level, the next FIFO word will be marked with an EFS-tag (z-axis LSB = 1). While the EFS-pin is kept at a High level, the corresponding FIFO words would be always marked with an EFS-tag. After the EFS-pin is reset to low level, the immediate next FIFO word could still be marked with the EFS-tag and only after this word, the next EFS-tag will be reset (z-axis LSB=0). This is shown in the above diagram.

The EFS-tag synchronizes external events with the same time precision as the FIFO update rate. Therefore update rate of the EFS-tag is determined by the output data rate and can be set from 100Hz up to 2,000Hz. For more information consult the register (*GYR 0x10*) (BW) in the register description.

10.2.4 Interface speed requirements for Gyroscope FIFO use

In order to use the FIFO effectively, larger blocks of data need to be read out quickly. Depending on the output data rate of the sensor, this can impose requirements on the interface.

The output data rate of the gyroscope is determined by the filter configuration (see chapter 8.2). What interface speed is required depends on the selected rate.

- For an I²C speed of 400 kHz, every filter mode can be used.
- For an I²C speed of 200 kHz, only modes with an output data rate of 1 KHz and below are recommended.
- For an I²C speed of 100 kHz, only modes with an output data rate of 400 Hz and below are recommended.

10.3 FIFO Frame Counter and Overrun Flag

The address ACC and GYR 0x0E bits<6:0> (frame_counter<6:0>) indicate the current fill level of the buffer. If additional frames are written to the buffer although the FIFO is full, the address ACC and GYR 0x0E bit 7 (overrun flag) is set. If the FIFO is reset, the FIFO fill level indicated in the frame_counter<6:0> is set to ‘0’ and the overrun flag is reset each time a write operation happens to the FIFO configuration registers. The overrun bit is not reset when the FIFO fill level frame_counter<6:0> has decremented to ‘0’ due to reading from the fifo_data<7:0> register.

10.4 FIFO Interrupts

The FIFO controller has the capability to issue two different interrupt events, the FIFO-full and the watermark event. Generally the FIFO-full and watermark interrupts are functional in all non-composite modes, including BYPASS.

In order to enable (disable) the watermark and the FIFO-full- interrupt for the accelerometer the (ACC 0x17) int_fwm_en bit, the int_ffull_en bit, as well as one or both of the int1_fwm or int2_fwm and int1_ffull or int2_ffull and bits must be set to '1' ('0'). For the gyroscope, the fifo_wm_en bit, the fifo_en bit, as well as one or both of the int1_fifo or int2_fifo bits must be set. Details are given in table 34 and table 35.

The **watermark interrupt** is asserted when the fill level in the buffer has reached the frame number defined by the water mark level trigger (ACC 0x30) and/or (GYR 0x3D). The status of the watermark interrupt for the accelerometer may be read back through the address (ACC 0x0A) bit 6 (fifo_wm_int) status bit. For the gyroscope it may be read back through the address (GYR 0x0A) bit 4 (fifo_int) status bit. Writing to water mark level trigger (ACC 0x30) and/or (GYR 0x3D) register clears the FIFO buffer.

The **FIFO-full interrupt** is the second interrupt capability associated with the FIFO. The FIFO-full interrupt is asserted when the buffer has been fully filled with samples. In FIFO mode this occurs:

- for the accelerometer 32 samples, in STREAM mode 31 samples, and in BYPASS mode 1 sample after the buffer has been cleared.
- for the gyroscope 100 samples, in STREAM mode 99 samples, and in BYPASS mode 1 sample after the buffer has been cleared.

The status of the FIFO-full interrupt for the accelerometer may be read back through the address (ACC 0x0A) bit (fifo_full_int) status bit. For the gyroscope it may be read back through the address (GYR 0x0A) bit 4 (fifo_int) status bit.

ACC Register	ACC Address
fifo_water_mark_level_trigger_retain <5:0>	0x30 bits<5:0>
int_fwm_en	0x17 bit 6
int_ffull_en	0x17 bit 5
int1_fwm	0x1A bit 1
int2_fwm	0x1A bit 6
int1_ffull	0x1A bit 2
int2_ffull	0x1A bit 5

Table 34: Interrupt configuration bits relevant for the accelerometer FIFO controller

GYR Register	GYR Address
h2o_mrk_lvl_trig_ret<6:0>	0x3D bits<6:0>
fifo_wm_en	0x1E bit 7
fifo_en	0x15 bit 6
int1_fifo	0x18 bit 2
int2_fifo	0x18 bit 5

Table 35: Interrupt configuration bits relevant for the gyroscope FIFO controller

11. Pin-out and connection diagram

11.1 Pin-out

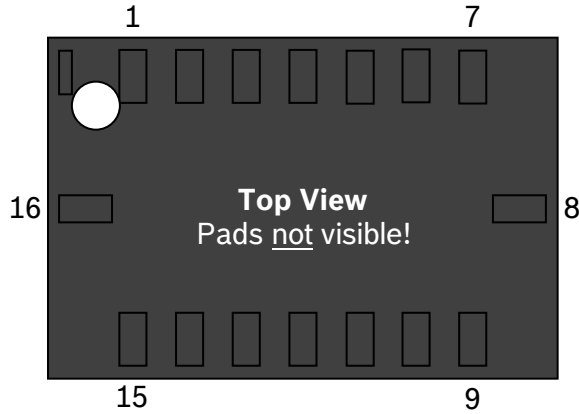

Figure 29: Pin-out top view

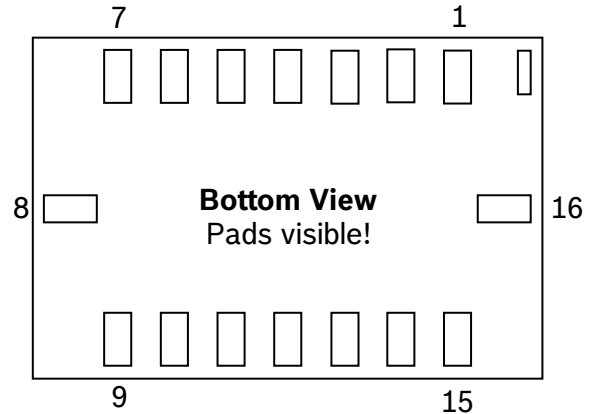

Figure 30: Pin-out bottom view

Table 36: Pin description

Pin#	Name	I/O Type	Description	Connect to		
				in SPI 4W	In SPI 3W	in I ² C
1*	INT2	Digital out	Interrupt pin 2 (accel int #2)	INT2	INT2	INT2
2	NC	--	--	GND	GND	GND
3	VDD	Supply	Power supply analog & digital domain (2.4 – 3.6V)	V _{DD}	V _{DD}	V _{DD}
4	GNDA	Ground	Ground for analog domain	GND	GND	GND
5	CSB2	Digital in	SPI Chip select Gyro	CSB2	CSB2	DNC (float)
6	GNDIO	Ground	Ground for I/O	GND	GND	GND
7	PS	Digital in	Protocol select (GND = SPI, V _{DDIO} = I ² C)	GND	GND	V _{DDIO}
8	SCx	Digital in	SPI: serial clock SCK I ² C: serial clock SCL	SCK	SCK	SCL
9	SDx	Digital I/O	I ² C: SDA serial data I/O SPI 4W: SDI serial data I SPI 3W: SDA serial data I/O	SDI	SDA	SDA
10	SDO2	Digital out	SPI Serial data out Gyro Address select in I ² C mode see chapter 9.2	SDO2	DNC (float)	GND for default addr.
11	VDDIO	Supply	Digital I/O supply voltage (1.2V ... 3.6V)	V _{DDIO}	V _{DDIO}	V _{DDIO}
12*	INT3	Digital I/O	Interrupt pin 3 (gyro int #1)	INT3	INT3	INT3
13*	INT4	Digital I/O	Interrupt pin 4 (gyro int #2)	INT4	INT4	INT4
14	CSB1	Digital in	SPI Chip select Accel	CSB1	CSB1	DNC (float)
15	SDO1	Digital out	SPI Serial data out Accel Address select in I ² C mode see chapter 9.2	SDO1	DNC (float)	GND for default addr.
16*	INT1	Digital out	Interrupt pin 1 (accel int #1)	INT1	INT1	INT1

* If INT are not used, please do not connect them (DNC)!

11.2 Connection diagram 4 wire SPI

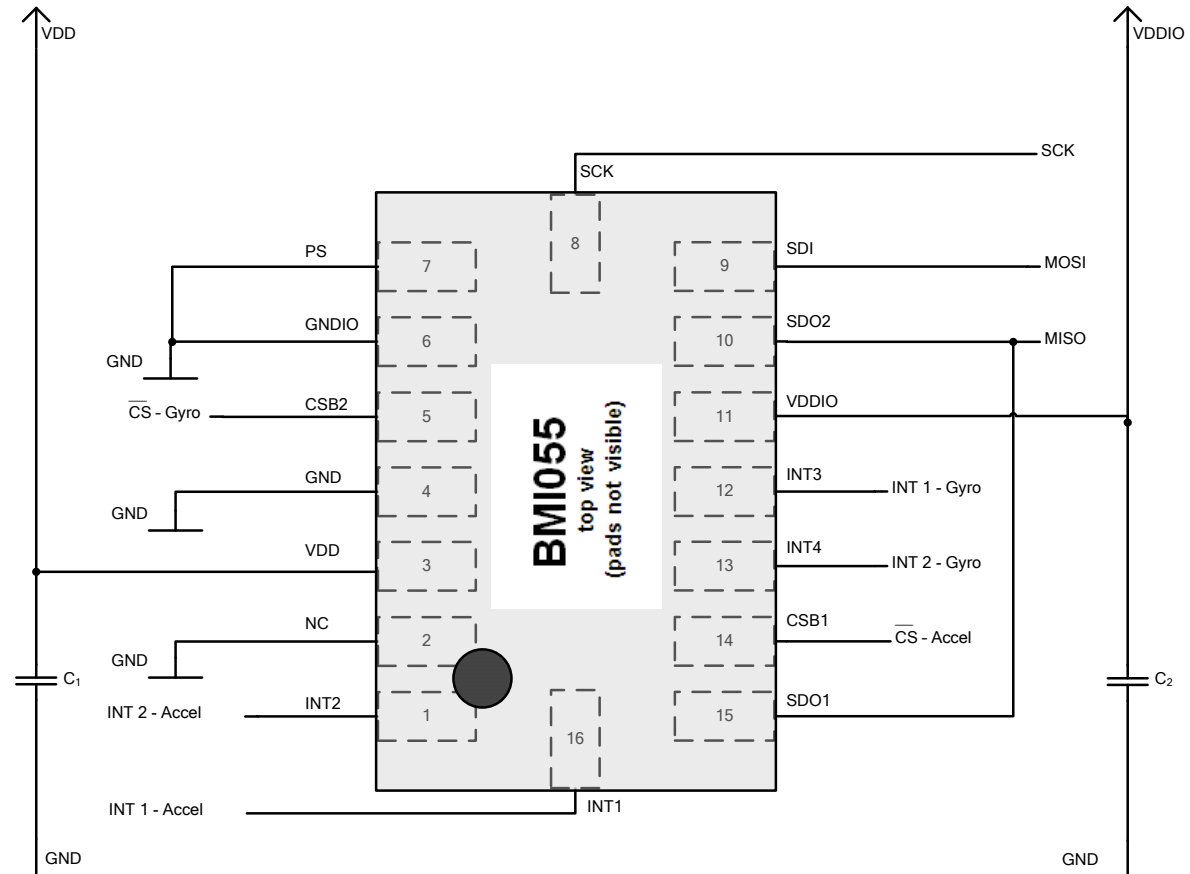

Figure 31: 4-wire SPI connection

11.3 Connection diagram 3-wire SPI

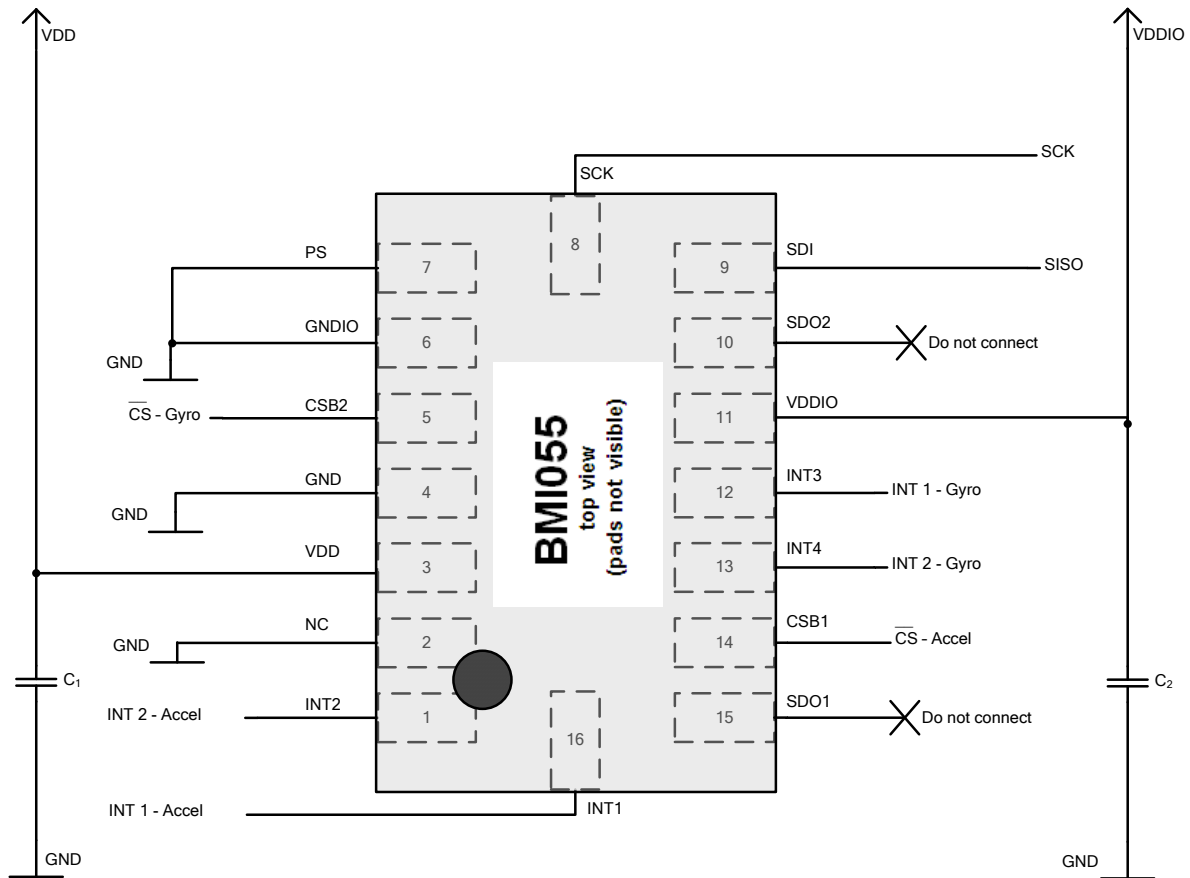

Figure 32: 3-wire SPI connection

11.4 Connection diagram I²C

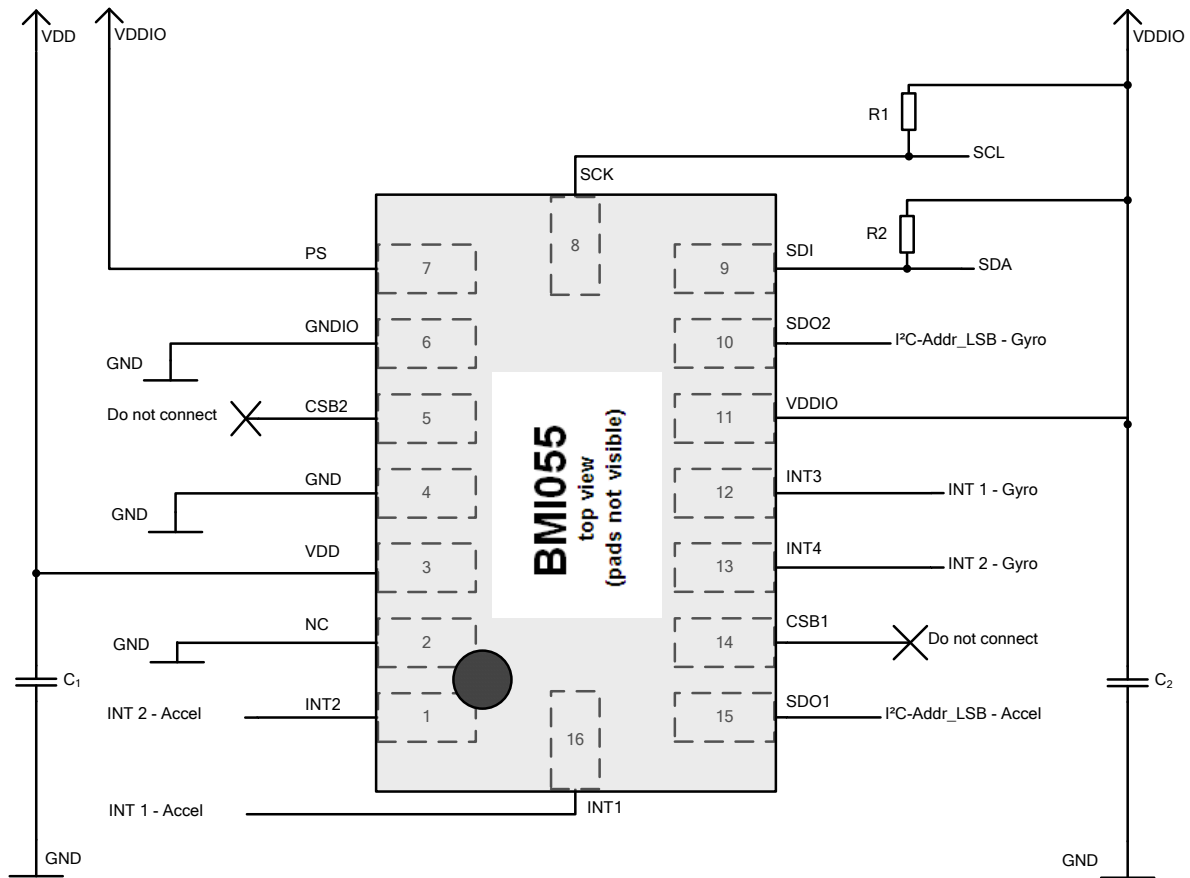

Figure 33: I²C connection

Note: the recommended value for C₁, C₂ is 100 nF.

12. Package

12.1 Outline dimensions

The sensor housing is a standard LGA package. Its dimensions are the following. Unit is mm. Note: Unless otherwise specified tolerance = decimal ± 0.05

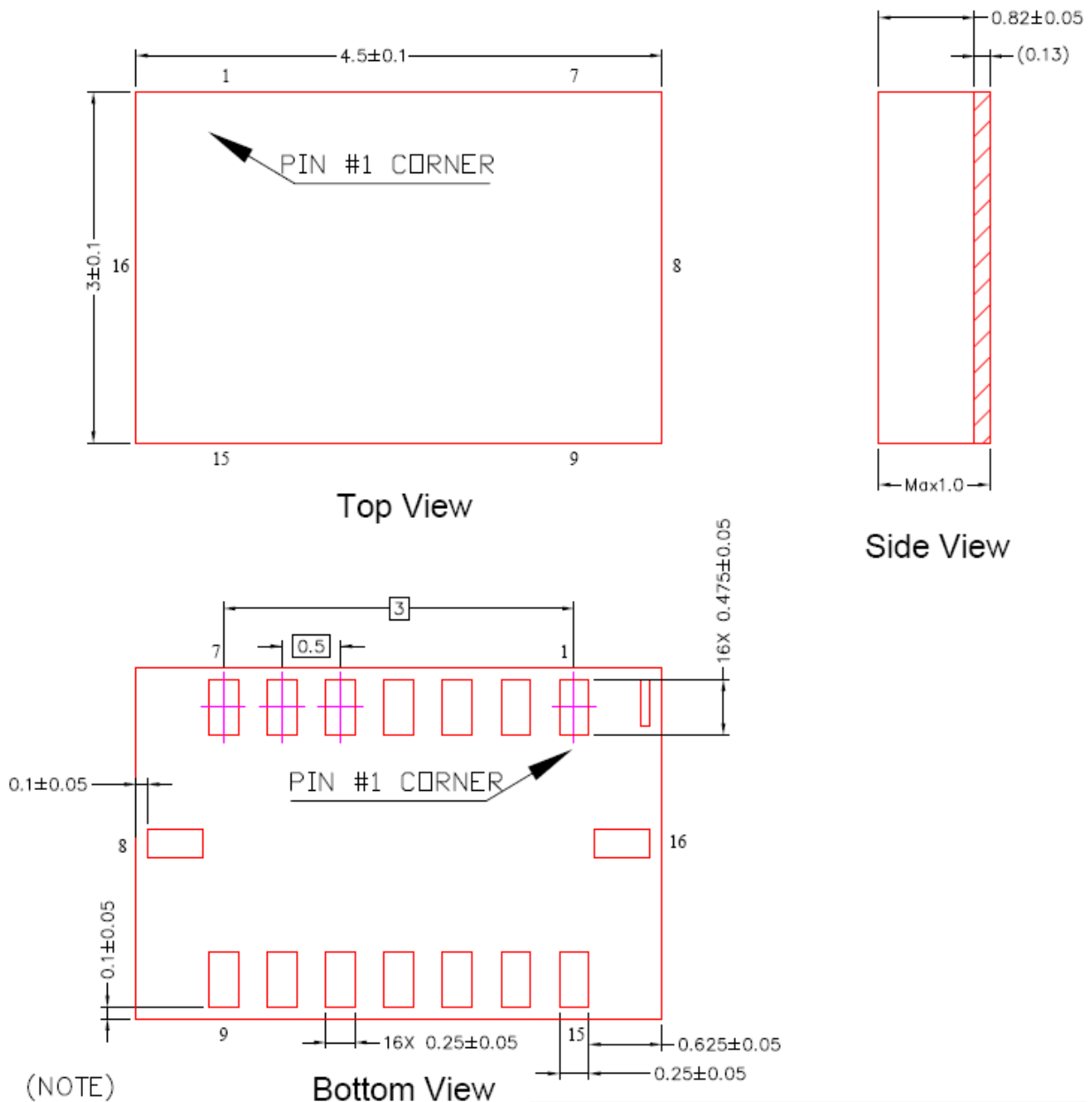

Figure 34: Package outline dimensions

12.2 Sensing axes orientation

If the sensor is accelerated and/or rotated in the indicated directions, the corresponding channels of the device will deliver a positive acceleration and/or yaw rate signal (dynamic acceleration). If the sensor is at rest without any rotation and the force of gravity is acting contrary to the indicated directions, the output of the corresponding acceleration channel will be positive and the corresponding gyroscope channel will be “zero” (static acceleration).

Example: If the sensor is at rest or at uniform motion in a gravity field according to the figure given below, the output signals are:

- $\pm 0g$ for the X ACC channel and $\pm 0^\circ/\text{sec}$ for the Ω_x GYR channel
- $\pm 0g$ for the Y ACC channel and $\pm 0^\circ/\text{sec}$ for the Ω_y GYR channel
- $+ 1g$ for the Z ACC channel and $\pm 0^\circ/\text{sec}$ for the Ω_z GYR channel

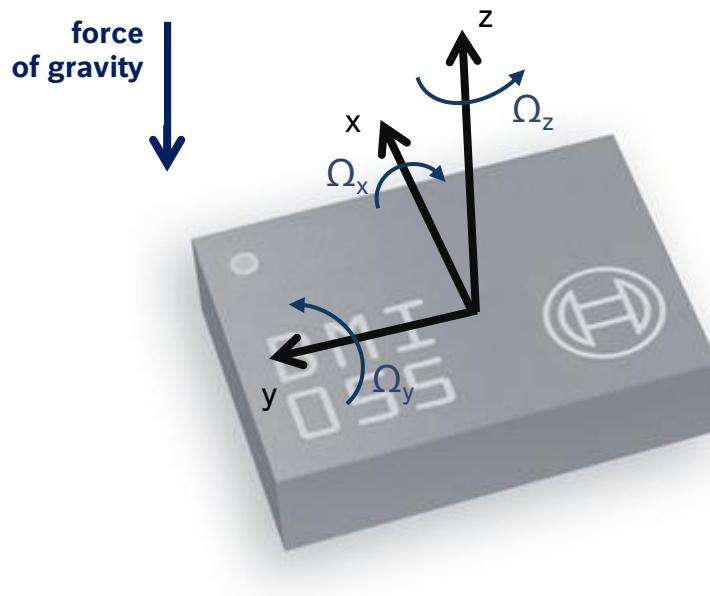
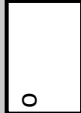
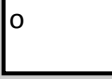
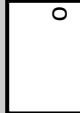

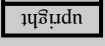

Figure 35: Orientation of sensing axis

The following table 37 lists all corresponding output signals on X, Y, Z and Ω_x , Ω_y , Ω_z while the sensor is at rest or at uniform motion in a gravity field under assumption of a $\pm 2g$ range setting and a top down gravity vector as shown above.

Table 37: Output signals depending on device orientation

Sensor Orientation (gravity vector) ↓						
Output Signal X	0g 0LSB	+1g +1024LSB	0g 0LSB	-1g -1024LSB	0g 0LSB	0g 0LSB
Output Signal Y	-1g -1024LSB	0g 0LSB	+1g +1024LSB	0g 0LSB	0g 0LSB	0g 0LSB
Output Signal Z	0g 0LSB	0g 0LSB	0g 0LSB	0g 0LSB	+1g +1024LSB	-1g -1024LSB
Output Signal Ω_x	0°/sec 0LSB	0°/sec 0LSB	0°/sec 0LSB	0°/sec 0LSB	0°/sec 0LSB	0°/sec 0LSB
Output Signal Ω_y	0°/sec 0LSB	0°/sec 0LSB	0°/sec 0LSB	0°/sec 0LSB	0°/sec 0LSB	0°/sec 0LSB
Output Signal Ω_z	0°/sec 0LSB	0°/sec 0LSB	0°/sec 0LSB	0°/sec 0LSB	0°/sec 0LSB	0°/sec 0LSB

12.3 Landing pattern recommendation

For the design of the landing patterns, we recommend the following dimensioning:

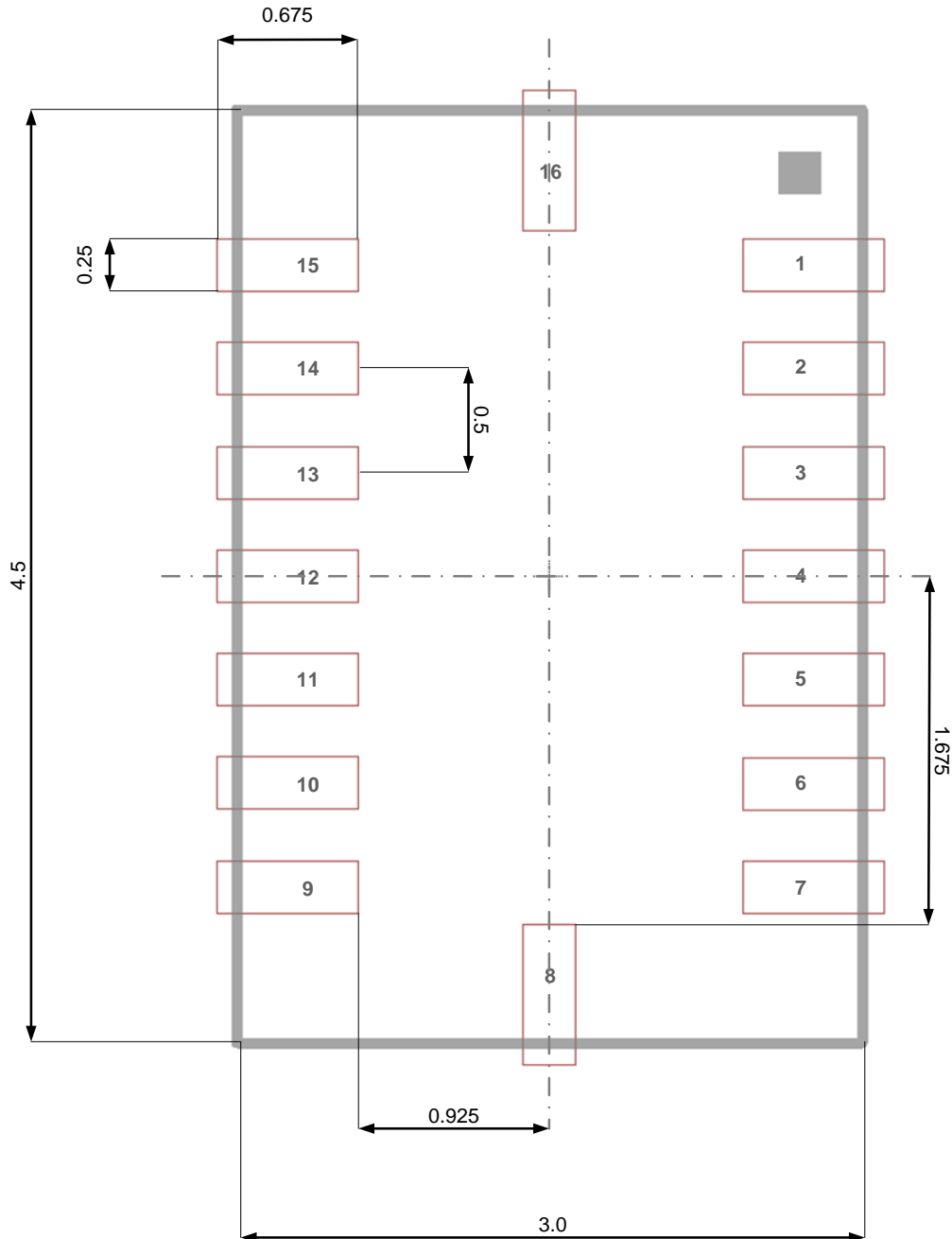

Figure 36: Landing patterns, dimensions are in mm

Same tolerances as given for the outline dimensions (chapter 12.1, fig. 34) should be assumed. A wiring no-go area in the top layer of the PCB below the sensor is strongly recommended (e.g. no vias, wires or other metal structures).

12.4 Marking

12.4.1 Mass production samples

Table 38: Marking of mass production parts

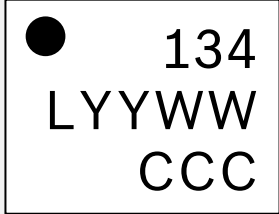
Labeling	Name	Symbol	Remark
	Product number	134	3 numeric digits, fixed to identify product type
	Sub-con ID	L	1 alphanumeric digit, variable to identify sub-con
	Date-Code	YYWW	4 numeric digits, fixed to identify YY = "year" WW = "working week"
	Lot counter	CCCC	4 alphanumeric digits, variable to generate mass production trace-code
	Pin 1 identifier	●	--

12.4.2 Engineering samples

Table 39: Marking of engineering samples

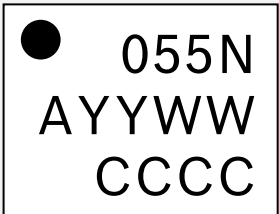
Labeling	Name	Symbol	Remark
	Eng. sample ID	N	1 alphanumeric digit, fixed to identify engineering sample, N = "+" or "e" or "E"
	Sample ID	AYYWW	1 alphanumeric digit (A) to generate trace-code 2 numeric digit (YY) to generate date-code 2 numeric digit (WW) to generate date-code
	Counter ID	CCCC	4 alphanumeric digits, variable to generate trace-code
	Pin 1 identifier	●	--

12.5 Soldering guidelines

The moisture sensitivity level of the BMI055 sensors corresponds to JEDEC Level 1, see also

- IPC/JEDEC J-STD-020C “Joint Industry Standard: Moisture/Reflow Sensitivity Classification for non-hermetic Solid State Surface Mount Devices”
- IPC/JEDEC J-STD-033A “Joint Industry Standard: Handling, Packing, Shipping and Use of Moisture/Reflow Sensitive Surface Mount Devices”

The sensor fulfils the lead-free soldering requirements of the above-mentioned IPC/JEDEC standard, i.e. reflow soldering with a peak temperature up to 260°C.

Profile Feature	Pb-Free Assembly
Average Ramp-Up Rate (T _{Smax} to T _p)	3° C/second max.
Preheat	
- Temperature Min (T _{Smin})	150 °C
- Temperature Max (T _{Smax})	200 °C
- Time (t _s to t _{Smax})	60-180 seconds
Time maintained above:	
- Temperature (T _L)	217 °C
- Time (t _L)	60-150 seconds
Peak/Classification Temperature (T _p)	260 °C
Time within 5 °C of actual Peak Temperature (t _p)	20-40 seconds
Ramp-Down Rate	6 °C/second max.
Time 25 °C to Peak Temperature	8 minutes max.

Note 1: All temperatures refer to topside of the package, measured on the package body surface.

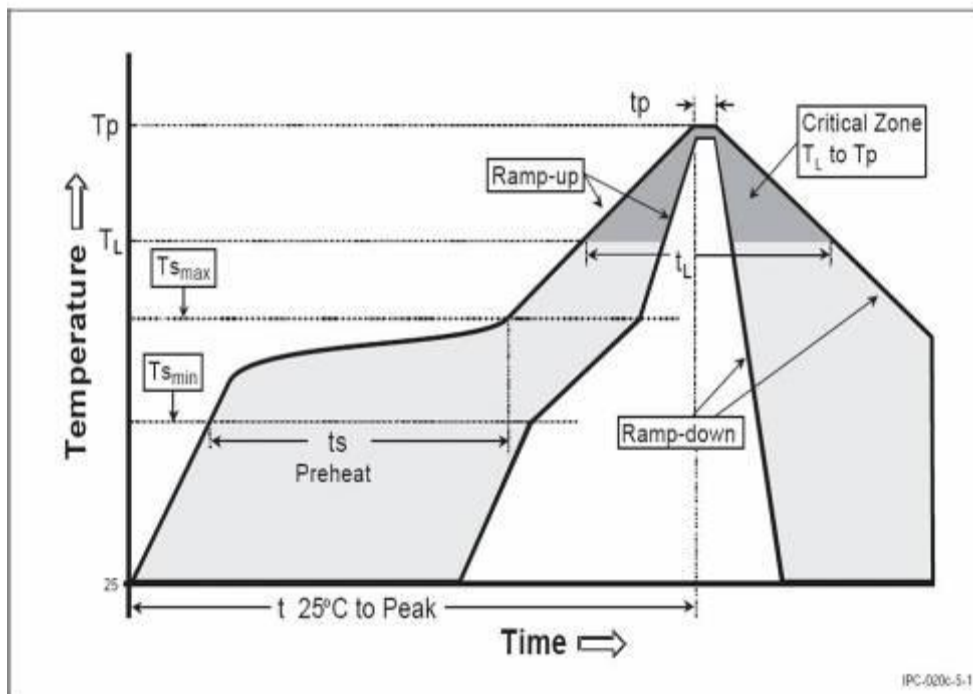

Figure 37: Soldering profile

12.6 Handling instructions

Micromechanical sensors are designed to sense acceleration with high accuracy even at low amplitudes and contain highly sensitive structures inside the sensor element. The MEMS sensor can tolerate mechanical shocks up to several thousand g's. However, these limits might be exceeded in conditions with extreme shock loads such as e.g. hammer blow on or next to the sensor, dropping of the sensor onto hard surfaces etc.

We recommend to avoid g-forces beyond the specified limits during transport, handling and mounting of the sensors in a defined and qualified installation process.

This device has built-in protections against high electrostatic discharges or electric fields (e.g. 2kV HBM); however, anti-static precautions should be taken as for any other CMOS component. Unless otherwise specified, proper operation can only occur when all terminal voltages are kept within the supply voltage range. Unused inputs must always be tied to a defined logic voltage level.

12.7 Tape and reel specification

The BMI055 is shipped in a standard cardboard box.

The box dimension for 1 reel is: L x W x H = 35cm x 35cm x 6cm.

BMI055 quantity: 5,000pcs per reel, please handle with care.

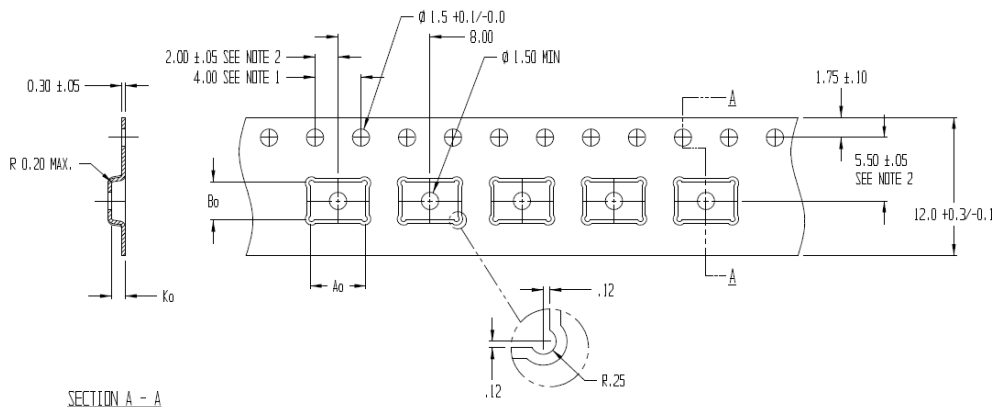

$$A_0 = 4.85$$

$$B_0 = 3.35$$

$$K_0 = 1.20$$

Figure 38: Tape and reel dimensions in mm

12.7.1 Orientation within the reel

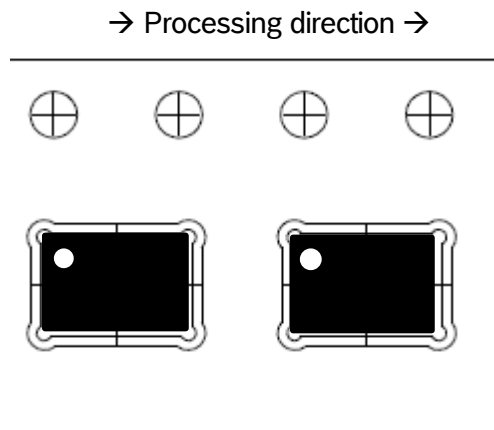

Figure 39: Orientation of the BMI055 devices relative to the tape

12.8 Environmental safety

The BMI055 sensor meets the requirements of the EC restriction of hazardous substances (RoHS) directive, see also:

Directive 2002/95/EC of the European Parliament and of the Council of 27 January 2003 on the restriction of the use of certain hazardous substances in electrical and electronic equipment.

12.8.1 Halogen content

The BMI055 is halogen-free. For more details on the analysis results please contact your Bosch Sensortec representative.

12.8.2 Internal package structure

Within the scope of Bosch Sensortec's ambition to improve its products and secure the mass product supply, Bosch Sensortec qualifies additional sources (e.g. 2nd source) for the LGA package of the BMI055.

While Bosch Sensortec took care that all of the technical packages parameters are described above are 100% identical for all sources, there can be differences in the chemical content and the internal structural between the different package sources.

However, as secured by the extensive product qualification process of Bosch Sensortec, this has no impact to the usage or to the quality of the BMI055 product.

13. Legal disclaimer

13.1 Engineering samples

Engineering Samples are marked with an plus (+) or (e) or (E) or (N). Samples may vary from the valid technical specifications of the product series contained in this data sheet. They are therefore not intended or fit for resale to third parties or for use in end products. Their sole purpose is internal client testing. The testing of an engineering sample may in no way replace the testing of a product series. Bosch Sensortec assumes no liability for the use of engineering samples. The Purchaser shall indemnify Bosch Sensortec from all claims arising from the use of engineering samples.

13.2 Product use

Bosch Sensortec products are developed for the consumer goods industry. They may only be used within the parameters of this product data sheet. They are not fit for use in life-sustaining or security sensitive systems. Security sensitive systems are those for which a malfunction is expected to lead to bodily harm or significant property damage. In addition, they are not fit for use in products which interact with motor vehicle systems.

The resale and/or use of products are at the purchaser's own risk and his own responsibility. The examination of fitness for the intended use is the sole responsibility of the Purchaser.

The purchaser shall indemnify Bosch Sensortec from all third party claims arising from any product use not covered by the parameters of this product data sheet or not approved by Bosch Sensortec and reimburse Bosch Sensortec for all costs in connection with such claims.

The purchaser must monitor the market for the purchased products, particularly with regard to product safety, and inform Bosch Sensortec without delay of all security relevant incidents.

13.3 Application examples and hints

With respect to any examples or hints given herein, any typical values stated herein and/or any information regarding the application of the device, Bosch Sensortec hereby disclaims any and all warranties and liabilities of any kind, including without limitation warranties of non-infringement of intellectual property rights or copyrights of any third party. The information given in this document shall in no event be regarded as a guarantee of conditions or characteristics. They are provided for illustrative purposes only and no evaluation regarding infringement of intellectual property rights or copyrights or regarding functionality, performance or error has been made.

14. Document history and modification

Rev. No	Chapter	Description of modification/changes	Date
0.1	-	Initial release	13-March-2012
0.2	1	Updates in tables 1, 2 and 3	30 June 2012
	2	Updates, also in table 4	
	3	Update, also figure 1	
	4	Various major updates	
	5	Various updates	
	6	Various updates in memory mad accelerometer	
	7.4	New feature: Gyroscope self-test	
	8	Various updates in memory gyroscope	
	9.2.1	Update	
	10	Update	
		11.2, 11.3, 11.4	
	12.1, 12.4	Updates	
	13	Update	
0.5	1.2	Update table 2, table 3	26 July 2012
	12.1	Update figure	
0.6	1.2	Table 2, update offset	21 October 2012
	5, 5.1	Various updates	
	6.2	ACC 0x38, 0x39, 0x4A	
	8.1	Memory map, minor updates	
	8.2	GYR 0x37, 0x38, 0x39, 0x34	
	9	Updated tables 28, 29	
	10.2.3	New chapter	
12.3	Update figure 36		
0.7	-	Not released	
0.8	1	Update table 2	18 Dec. 2012
	2	Update table 4	
	4	Update	
	5.4.2	Update	
	5.6.8	Update	
	6	Update	
	8	GYR 0x06 / 0x07 update	
9.1	Table 30 update		
0.9	1.2	Table 2 current consumption updated, accel temperature sensor specification added	21 May 2013
	1.2	Table 3 current consumption updated	
	5.2.2	added Chapter 5.2.2 Temperature Sensor	
	5.6.3	Recommendation for pull-up/pull-down resistors added	
	5.6.6	Register address to set orient_hyst bit updated	
	6.2	Register 0x12 renamed	
	6.2	Register 0x08 (ACCD_TEMP) added	
	6.2	Register 0x30 Interrupt generation conditions updated	
	6.2	Register Accel map updated	
	8.2	Register map updated	
8.2	GYR Register 0x08 reserved		
12.3	Wiring no-go area recommendation added		

1.0	1.2	Table 2 updated	29 May 2013
	5.1	paragraph on deep suspend mode updated	
	5.1	Formulae for wake-up times updated	
	5.6.5.4	Constraints for usage with latched interrupts removed	
	5.7	Description of Softreset register updated	
	5.6.3	Recommendation to use pull-up, pull-down resistors added	
	7.5.2	Recommendation added to use fast offset compensation in range=125°/s	
	7.7	Comment added on limitation of gyro interrupts in other modes than normal mode	
	7.7.3	Recommendation to use pull-up, pull-down resistors added	
	10.4	FIFO interrupt description updated	
1.1	4	Recommendation on power on sequence removed	20 Sept 2013
1.2	8.2	GYR Register 0x15 description updated	24 July 2014
		GYR Register 0x3C (BIST) description updated	

Bosch Sensortec GmbH
 Gerhard-Kindler-Strasse 8
 72770 Reutlingen / Germany

contact@bosch-sensortec.com
 www.bosch-sensortec.com

Modifications reserved | Printed in Germany

Document number: BST-BMI055-DS000-08
 Revision_1.2_072014