

www.DataSheet4U.com

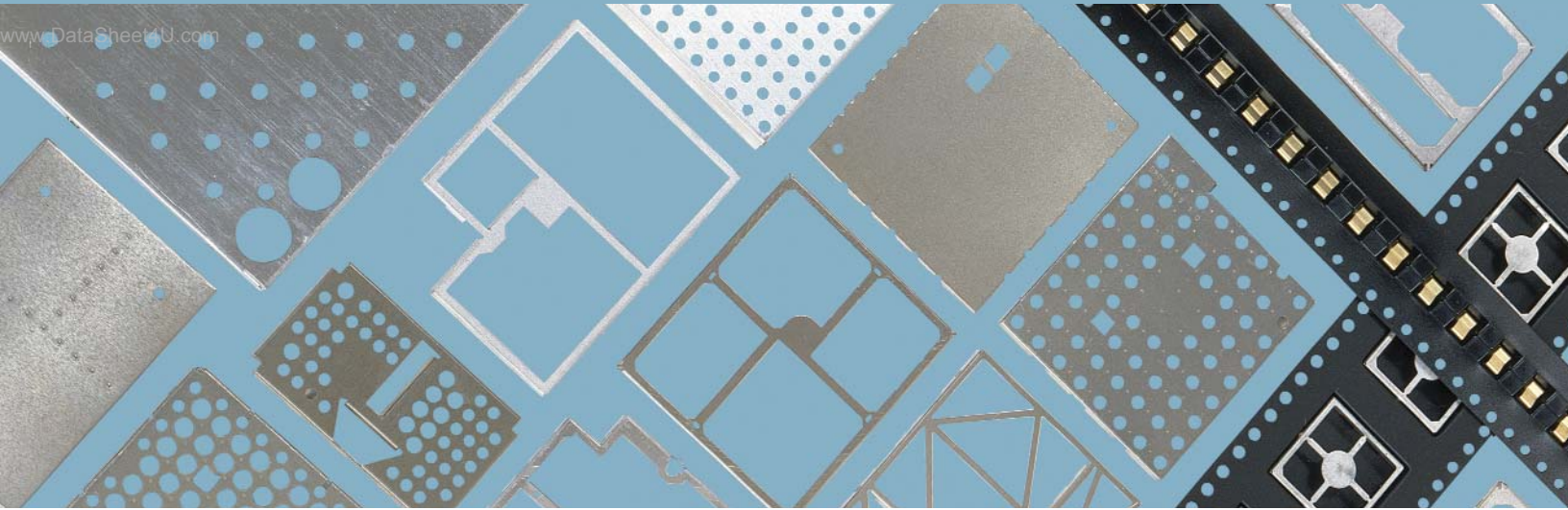

**BOARD LEVEL SHIELDS AND CONTACTS**

## CAPABILITIES

Laird Technologies is the recognized authority on board level shielding and contact applications because we focus on five key factors that lead to your success: best-in-industry part design, rapid prototyping automated assembly and packaging, built-in quality systems from design through final packaging and the responsiveness to meet your deadlines.

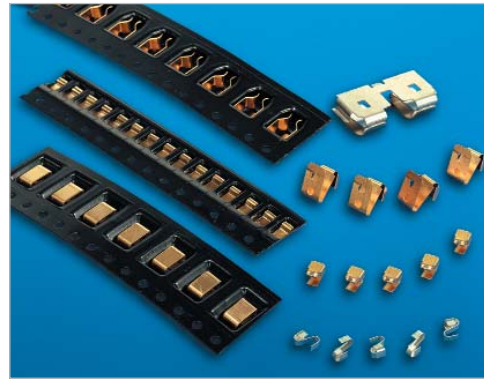

Our automated packaging allows for complex and small designs with lower installed costs.

www.DataSheet4U.com

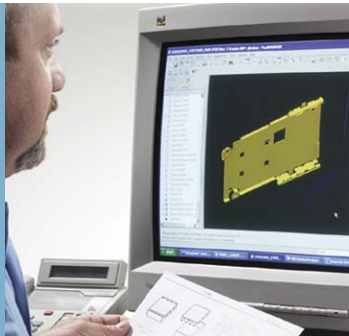

### Design Engineering

We can create part designs in just hours utilizing the latest Pro-Engineering/ AutoCAD systems.

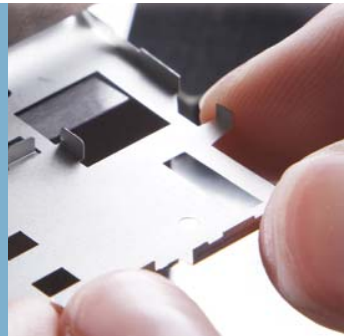

### Rapid Prototyping

We can deliver precision made parts in just a matter of days, packaged for automated installation.

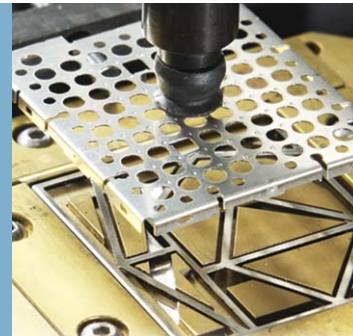

### Automated Assembly and Packaging

For innovations in packaging and shield assemblies, we have a dedicated in-house automation engineering department that continually develops original automation technologies.

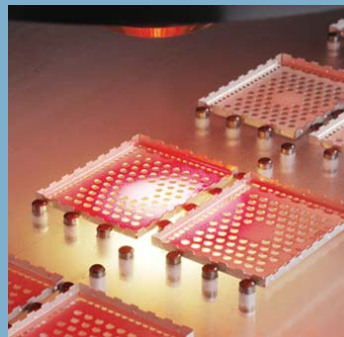

### Quality

Our quality systems ensure the best product available because they are built into the system from part design all the way through to final packaging—which is why we continually receive the highest ratings from our customer audits.



### Speed to Market

From initial design through final production, we bring everything together in a quick, efficient process that delivers you the solution you need, when you need it.

# TABLE OF CONTENTS

## INTRODUCTION TO BOARD LEVEL SHIELDS AND CONTACTS

Board Level Shields and Contacts . . . . .	2
Design Engineering . . . . .	2
Prototyped Parts . . . . .	2
Packaging Automation . . . . .	2
Quality—ISO 9001:2000 Certified . . . . .	2

## STANDARD DESIGN SHIELDS AND CONTACTS

Flex Shielding . . . . .	3
97-2000 Shields (Series 97-2000) . . . . .	4
Printed Circuit Board Shields (Series 97-860, 866, 870) . . . . .	6
Standard Surface Mount Shields—One-Piece and Two-Piece . . . . .	7
Part No. BMIS-101 and 201 . . . . .	8
Part No. BMIS-102 and 202 . . . . .	9
Part No. BMIS-103 and 203 . . . . .	10
Part No. BMIS-104 and 204 . . . . .	11
Part No. BMIS-105 and 205 . . . . .	12
Part No. BMIS-106 and 206 . . . . .	13
Part No. BMIS-107 and 207 . . . . .	14
Part No. BMIS-210 . . . . .	15
EZ Peel™ Standard Shields . . . . .	16
Part No. 97-2002 . . . . .	17
Part No. 97-2003 . . . . .	17
Part No. 97-2004 . . . . .	17
Part No. 97-2005 . . . . .	17
Standard Precision Electronic Contacts . . . . .	18
Part No. BMIC-001 . . . . .	18
Part No. BMIC-002 . . . . .	18
Part No. BMIC-004 . . . . .	18
Part No. BMIC-006 . . . . .	18
Part No. BMIC-007-01 . . . . .	19
Part No. BMIC-010 . . . . .	19
Standard Prototype Parts . . . . .	19

## CUSTOM DESIGN SHIELDS AND CONTACTS

Introduction . . . . .	20
One-Piece Shield Design . . . . .	20
Two-Piece Shield Design . . . . .	20
EZ Peel™ Shield Design . . . . .	21
Multi-Compartmental Shield Design . . . . .	21
Shield-Lite™ . . . . .	21
InsulShield™ . . . . .	21
Drawn Board Level Shields (Series 97-2100) . . . . .	22
Dyna-Form . . . . .	23
Custom Precision Electronic Contacts . . . . .	24

## BOARD LEVEL SHIELDS AND CONTACTS

Whether it's a one-piece shield, multi-compartmental shield or precision contact, each solution Laird Technologies delivers is designed to provide maximum performance within a minimum timeline. We produce metal electronic components that are packaged for surface mount applications for a wide range of industries.

Laird Technologies has developed expertise in a number of key areas in order to ensure that the part we provide not only performs, but also optimizes the particular application.

Here's how we help you succeed:

### DESIGN ENGINEERING

The first step in any project is determining the right board level shield or contact design for your application. Based upon your specifications, our experts use the latest Pro-Engineering/AutoCAD systems to develop part designs in just hours. Our engineers draw on their extensive experience with application engineering, advanced design and materials engineering to solve your most complex board level shield and contact problems.

However, we don't limit our expertise to the part itself; our experienced engineers and technical specialists look beyond the component to the total application. They work with you to engineer the ideal finished product at the best value. Example considerations include board layout, EMI shielding requirements and grounding terminations.

### FAST TURNAROUND ON PROTOTYPED PARTS

Because speed in the prototyping process is critical to production success, Laird Technologies has built a process to quickly respond—within days—with a prototyped part. And, because we manufacture precision parts with no allowed deviances, the part we prototype meets the tolerances of a progressive die manufacturing production environment.

If design modifications are necessary, our prototype department has the flexibility to address your changes without affecting the delivery of your prototyped part. To ensure your parts deliver optimum performance and meet your specifications, all prototyped parts are 100% inspected on critical dimensions.

Laird Technologies also provides pre-production support to help you get your production line up and running quickly. Parts designed in pre-production can be supplied to you while your progressive die tools are being produced.

Manufacturing plants in locations throughout North America, Asia and Europe provide worldwide access to parts and offer the capacity to handle any size job.

## PACKAGING AUTOMATION

For innovations in packaging and in shield assemblies, we have a dedicated in-house automation engineering department routinely developing new automation technologies.

We offer a wide array of packaging options for shields and contacts, including tape and reel, tray, tube and bulk. Laird Technologies' tape and reel packaging allows for the lowest installed cost and is Electronic Industries Association (EIA) 481 compliant. Tape sizes are supplied on 13-inch and 15-inch diameter reels. A transparent cover tape allows component verification and inspection without having to remove or handle components.

Two-piece shields, including multi-compartmental shields, can be packaged as either assembled or unassembled parts.

Our innovative automation engineering allows engineers to design small and complex contacts requiring pick-up zones of 1 mm and weighing less than 0.01 grams. Our custom automation equipment places the miniature contacts into tape pockets quickly and cost effectively. The tape and reel packaged parts are now ready for installation onto printed circuit boards using standard pick-and-place equipment.

We can use vision recognition marks, such as holes and tabs, to orient your parts. This eliminates an added step and leads to faster production. We also ensure each design has an adequate pick-up area for pick-and-place equipment, without sacrificing performance.

### QUALITY—ISO 9001:2000 CERTIFIED

Laird Technologies places a premium on quality, which is why we have received the highest ratings on major customer qualification audits and our customers continually rank us among their top suppliers for quality performance. Our board level shield and contact facilities are ISO 9001:2000 certified by TUV-America Inc.

Built-in quality systems, including our proprietary 100% automated co-planarity inspection for our board level shields, ensure our rigid standards are met through all stages of operations (design, production, shipping, as well as prompt customer concern resolution).

We execute real-time, automated SPC on all critical dimensions throughout production. By taking these measurements, our quality assurance technicians can make necessary adjustments on the spot to ensure you receive quality parts on schedule. We maintain traceability with SPC results for all jobs; captured data includes operator, shift, raw material, job number, work center and more. Additionally, non-contact, automated coordinate measuring machines (CMM) are located throughout our factory floors.



## FLEX SHIELDING

Laird Technologies provides the across the board solution to your board level shielding needs with Flex Shielding. All your shielding needs are identified and satisfied.

Flex Shielding is available in a rectangular two-piece design. The frame is soldered to the grounding trace on the PCB. The ground plane of the PCB forms the bottom side of the shielding enclosure. After post-reflow inspection, the cover snaps onto the frame to complete the shielding system. Access to components is a snap. If repair of components is needed, the cover can quickly be removed and replaced as required.

Flex Shielding allows you the flexibility to specify the length and width of the board level shielding system with sizes available from 0.5" to 4.0" in 0.010" increments. Whether your needs specify a 2.1" x 3.6" shield - or a 0.7" x 1.3" shield, we have them. With over 6000 sizes available rest assured all of your shielding needs will be fulfilled.

Available in heights ranging from 0.150" to 0.500" in increments of 0.010".

### PART NUMBER INFORMATION

Cover:

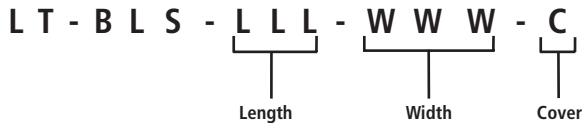

Example:

LT-BLS-250-190-C is a cover with matching frame with a length of 2.500" and width of 1.900".

Frame:

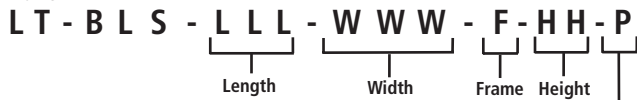

Pin at center of all four sides. Leave blank if no pins.

Example:

LT-BLS-120-050-F-15-P is a frame 1.200" long by 0.050" wide with a 0.150" height.

Our shields are made from high quality steel for excellent shielding performance across a wide frequency range. The tin plated surface provides excellent solderability and compatibility with lead-free processes.

All quantities - large and small - are efficiently managed including quick delivery and no high tooling fees.

Drawings, 3D CAD data and Solder Pad Layout can be provided upon request.

- Available in a wide variety of sizes from 0.5" to 4.0".
- Available in a wide variety of heights from 0.150" to 0.500".
- Cover design provides retention even when severe shock and vibration are encountered.
- Cover specially designed for easy removal and replacement.
- Fast deliveries.
- Competitive pricing.

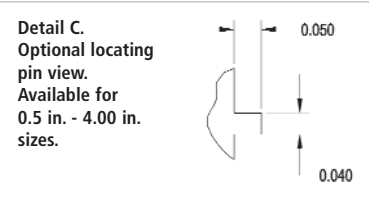
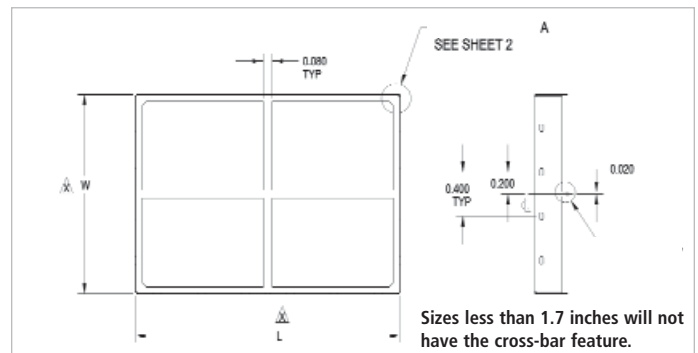
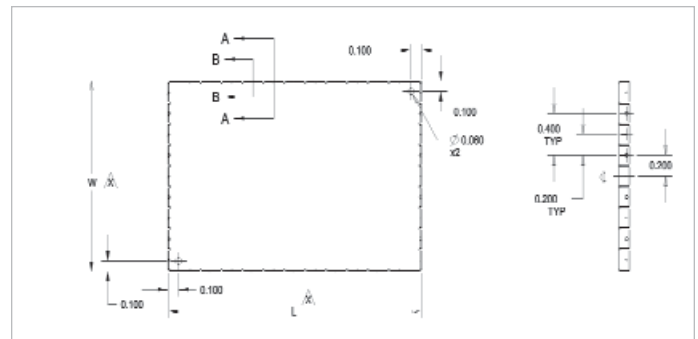

All dimensions shown in inches unless otherwise specified.



## 97-2000 SHIELDS

### A Range of Pin and Pad Mounting Styles Maximizes Flexibility

The 97-2000 series allow you mounting options that include various pin styles for through-hole mounting or pad styles for surface mounting. The frame material forms the walls of the enclosure, and the cover is held securely in place by spring force alone. The cover can be easily removed and replaced to provide access to the components. Large or small quantities can be easily manufactured using our automated tooling, short run capabilities or photo-chemical machining operations.

- 97-2000 frame heights from 0.130" (3.3 mm) to 1" (25.4 mm), with other heights available upon request
- Cover design permits retention even when severe shock or vibration are a consideration; cover was specifically designed for easy removal and replacement
- Design allows for automated pick-and-place operations
- Locking feature on frame guarantees corner joint stability
- Wide variety of pin style options, including a surface mountable style. Pin location can be to your customized hole location or a defined pitch
- Frames can be hand-formed or can be supplied formed and with cover assembled
- A modified pin style is available for extra retention in through hole application

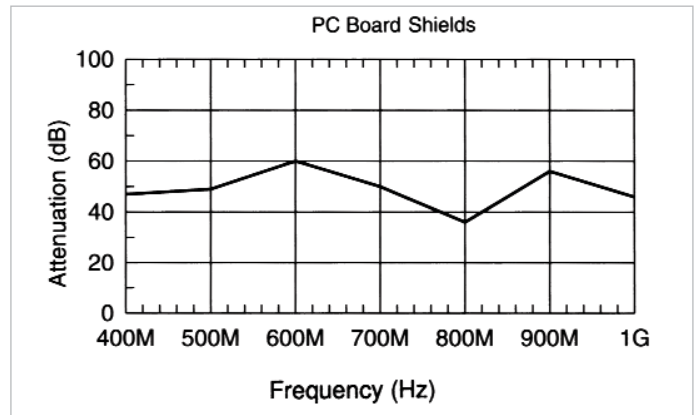
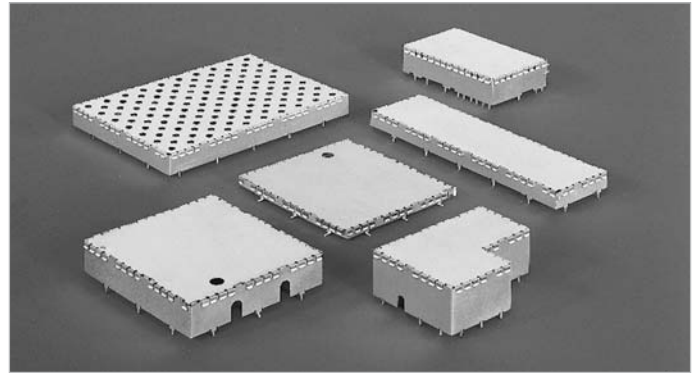

▲ Test performance in accordance with MIL-STD-285 using an aperture the same size as the 1-3/4" x 2" (44.5 mm x 5.08 mm) PC shield as reference. Measurement below 400 MHz were not possible because of the aperture attenuation.

## 97-2000 SHIELDS

### Frame Height and Pin Option

#### PIN STYLE 1.

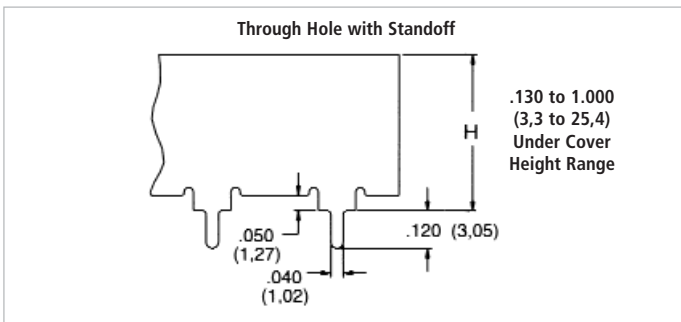
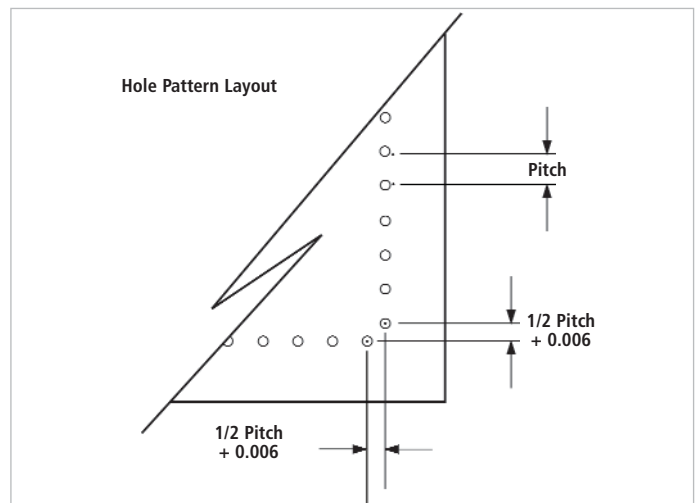

FIGURE 1.



(Consult engineering for irregular hole patterns.)

All dimensions shown are in inches (millimeters) unless otherwise specified.



PIN STYLE 2.

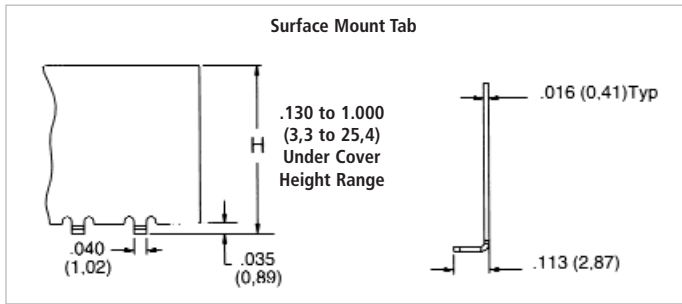
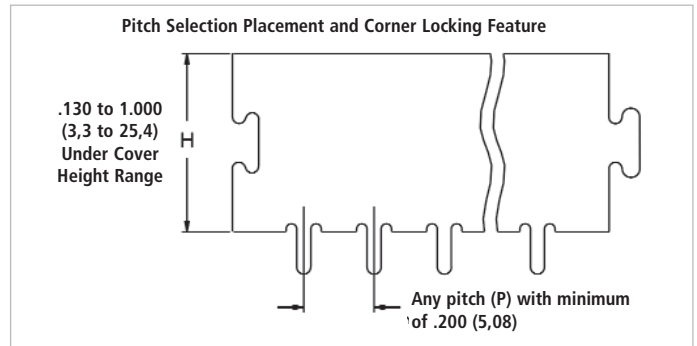

FIGURE 2.



www.DataSheet4U.com

PIN STYLE 3.

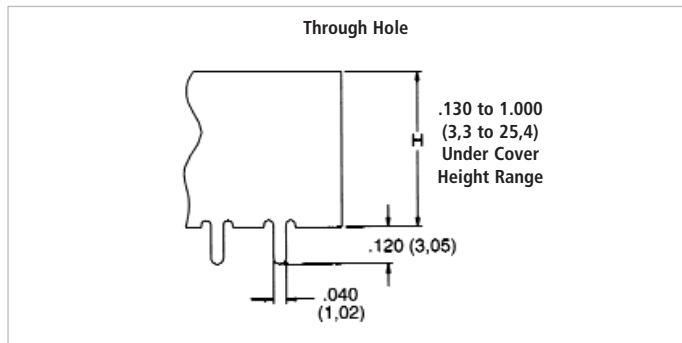
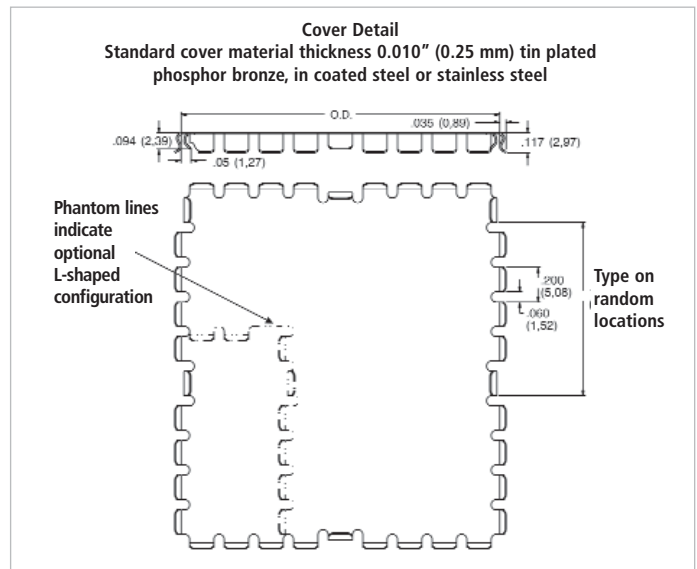
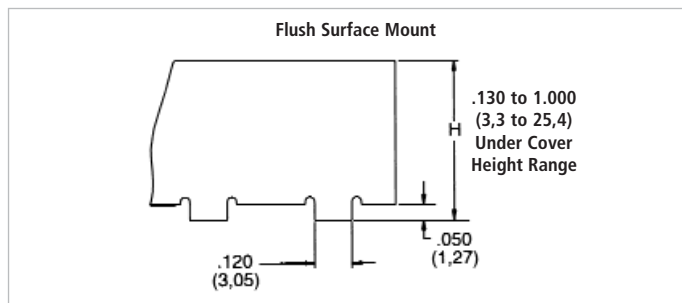

FIGURE 3.



PIN STYLE 4.



All dimensions shown are in inches (millimeters) unless otherwise specified.



## High-Performance, Readily Available

Laird Technologies' standard board level shields and contacts offer readily available, low-cost EMI shield and contact alternatives to custom designed solutions. Yet, you can still expect custom attention in terms of high quality and service. We offer a variety of sizes and designs to choose from, so you can count on finding a product that will deliver the results your project requires. However, should your choice not fully fit your space requirement constraints, we can modify any one our standard designs.

Our standard shields and contacts are available in a wide range of material choices, and all allow for full solderability. Standard shield offerings incorporate proprietary design criteria for maximum performance and are available in one-piece and two-piece designs. Laird Technologies' standard contacts base materials include beryllium-copper, phosphor bronze, nickel and stainless steel. They offer many plating options to allow for maximum electrical current carrying performance.

## PC SHIELD DIMENSIONS

SERIES	A	B	C	D	E	APPROX. LENGTH FT. (M)
97-860	.52 (13.2)	.045 (1.1)	.12 (3.2)	.03 (0.8)	.40 (10.2)	25 (7.6)
97-866	.82 (20.8)	.045 (1.1)	.12 (3.2)	.03 (0.8)	.70 (17.8)	25 (7.6)
97-870	1.12 (28.4)	.045 (1.1)	.12 (3.2)	.03 (0.8)	1.00 (25.4)	25 (7.6)

Other heights and custom-designed cover configurations available. Consult sales department.

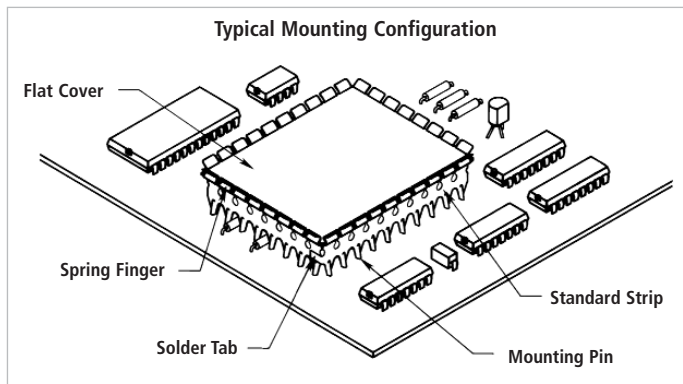

## PRINTED CIRCUIT BOARD SHIELDS

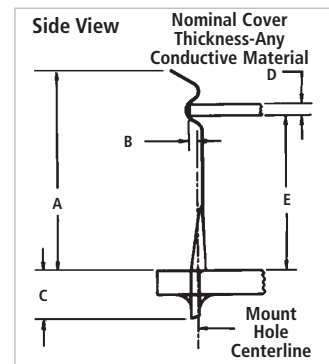
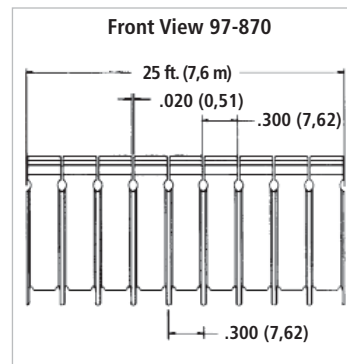
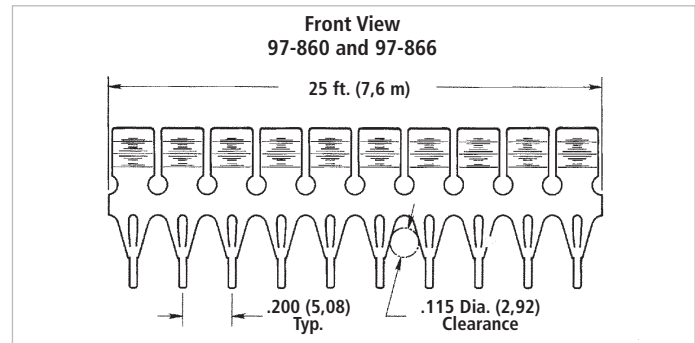
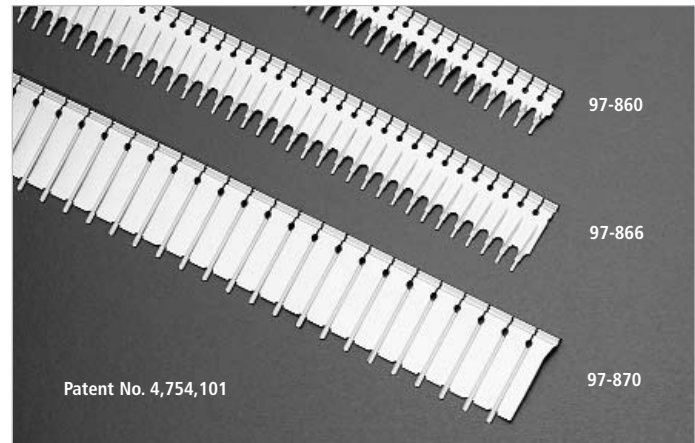

All dimensions shown are in inches (millimeters) unless otherwise specified.





## STANDARD SURFACE MOUNT SHIELDS—ONE-PIECE Off the Shelf, On Spec and On Budget

Standard surface mount shields are available in both one-piece and two-piece designs. One-piece shields offer six sides of protection, with the sixth side being the board itself. One-piece designs offer economical shielding protection where access to covered components is not necessary. There are no tooling costs associated with either the one and/or two-piece design.

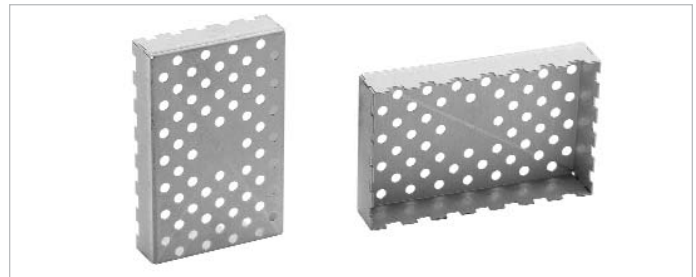

## STANDARD SURFACE MOUNT SHIELDS—TWO-PIECE Reduce Board Damage From Inspection and Repairs

Two-piece board level shields offer users the flexibility to inspect or repair shielded components without having to risk board damage by removing the entire shield or incur any tooling costs. Covers snap on and off with ease, which makes repair of the component under the shield quicker and easier and reduces board re-work. Two-piece shields are available unassembled\*, and are designed to survive drop, shock and no-rattle tests.

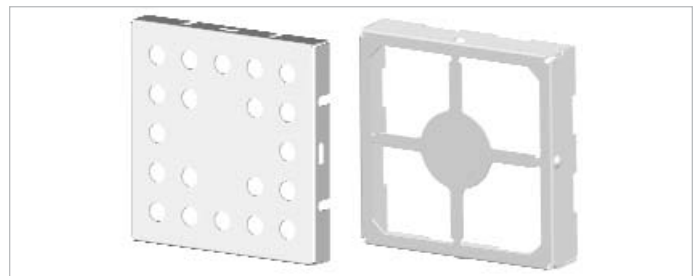

\*Pre-assembly is an option. Consult Sales.

### TYPICAL PROPERTIES & PERFORMANCE – ALL PART NUMBERS

PROPERTY	TEST METHOD	RESULT
Co-planarity	LTW-1119	<0.10 mm
Solderability	ANSI/JSTD-002	>99%
Solderability	MIL-STD-202 Method 208	>99%
Surface Mount Solderability	ANSI/EIA 638	Passes
Appearance	LTIES-125	Passes
Adhesion	ASTM B-571	Passes
3 Axis Mechanical Shock	LTES-461	Passes

### DESIGN PARAMETERS – ALL PART NUMBERS

PICK-UP SPOT DIAMETER	MATERIAL	MATERIAL THICKNESS	CARRIER TAPE MATERIAL
6 mm or greater	0.20 mm CRS Tin	0.20 mm	LTIMS-LCB
COVER TAPE MATERIAL	REEL DIAMETER	REEL MATERIAL	PACKAGING
LTIMS-PSA	330 mm (101, 102, 103, 104, 201, 202, 203, 204) 381 mm (105, 106, 107, 205, 206, 207)	Plastic	EIA-481

### STANDARD ONE-PIECE BOARD LEVEL SHIELDS

PART NUMBER	SURFACE AREA	MAXIMUM OVERALL DIMENSION	MAXIMUM OVERALL HEIGHT	CARRIER TAPE WIDTH	CARRIER TAPE PITCH	PARTS PER REEL	WEIGHT
BMIS-101	.253" (163.10 <sup>2</sup> )	.538 x .476 (13.66 x 12.10)	.100 (2.54)	24 mm	20 mm	1000	0.4 g
BMIS-102	.402" (259.21 <sup>2</sup> )	.650 x .650 (16.50 x 16.50)	.142 (3.60)	32 mm	24 mm	700	0.7 g
BMIS-103	1.033" (666.16 <sup>2</sup> )	1.032 x 1.032 (26.2 x 26.21)	.200 (5.08)	44 mm	32 mm	300	1.6 g
BMIS-104	1.548" (998.56 <sup>2</sup> )	1.260 x 1.260 (32.00 x 32.00)	.236 (6.00)	44 mm	36 mm	225	2.4 g
BMIS-105	1.461" (942.50 <sup>2</sup> )	1.500 x 1.000 (38.10 x 25.40)	.236 (6.00)	56 mm	32 mm	250	2.4 g
BMIS-106	1.879" (1212.39 <sup>2</sup> )	1.450 x 1.326 (36.83 x 33.68)	.200 (5.08)	56 mm	40 mm	300	2.5 g
BMIS-107	2.997" (1933.36 <sup>2</sup> )	1.747 x 1.747 (44.37 x 44.37)	.384 (9.75)	56 mm	56 mm	120	6.5 g

### STANDARD TWO-PIECE BOARD LEVEL SHIELDS

PART NUMBER	SURFACE AREA	MAXIMUM OVERALL DIMENSION	MAXIMUM OVERALL HEIGHT	CARRIER TAPE WIDTH	CARRIER TAPE PITCH	PARTS PER REEL	WEIGHT
BMIS-201	.253" (163.10 <sup>2</sup> )	.538 x .476 (13.66 x 12.10)	.100 (2.54)	24 mm	20 mm	1000	0.3 g
BMIS-202	.402" (259.21 <sup>2</sup> )	.650 x .650 (16.50 x 16.50)	.142 (3.60)	32 mm	24 mm	700	0.5 g
BMIS-203	1.033" (666.16 <sup>2</sup> )	1.032 x 1.032 (26.21 x 26.21)	.200 (5.08)	44 mm	32 mm	300	1.0 g
BMIS-204	1.548" (998.56 <sup>2</sup> )	1.260 x 1.260 (32.00 x 32.00)	.236 (6.00)	44 mm	36 mm	225	1.6 g
BMIS-205	1.461" (942.50 <sup>2</sup> )	1.500 x 1.000 (38.10 x 25.40)	.236 (6.00)	56 mm	44 mm	250	1.6 g
BMIS-206	1.879" (1212.39 <sup>2</sup> )	1.450 x 1.326 (36.83 x 33.68)	.200 (5.08)	56 mm	40 mm	300	1.5 g
BMIS-207	2.997" (1933.36 <sup>2</sup> )	1.747 x 1.747 (44.37 x 44.37)	.384 (9.75)	56 mm	56 mm	120	3.2 g
BMIS-210	2.080" (1342 <sup>2</sup> )	1.732 x 1.201 (44.02 x 30.50)	.118 (3.00)	56 mm	40 mm	450	1.0 g

All dimensions shown are in millimeters unless otherwise specified.



# STANDARD DESIGN SHIELDS AND CONTACTS

## STANDARD SURFACE MOUNT SHIELD ONE-PIECE PART NO. BMIS-101

### DESIGN SPECIFICATIONS

PART NUMBER	SURFACE AREA	MAXIMUM OVERALL DIMENSION	MAXIMUM OVERALL HEIGHT	CARRIER TAPE WIDTH	CARRIER TAPE PITCH	PARTS PER REEL
BMIS-101	253" (163.10")	.538 x .476 (13.66 x 12.10)	.100 (2.54)	24 mm	20 mm	1000

### APPLICATIONS:

- Works exceptionally well in small component areas
- 48 VQFP

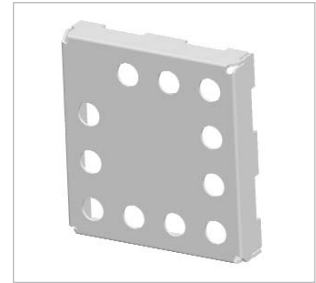

### Dimensions (mm)

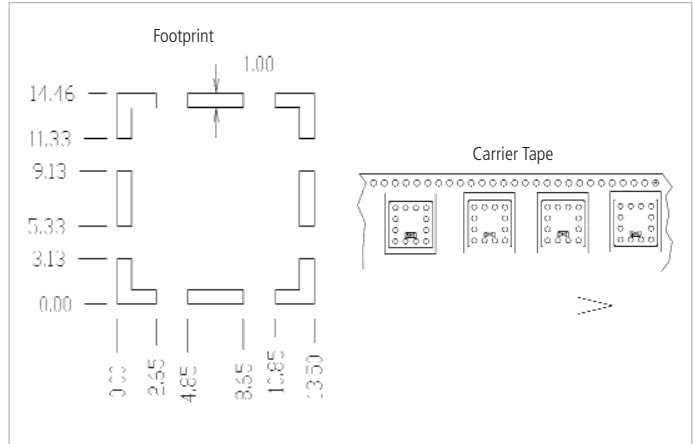
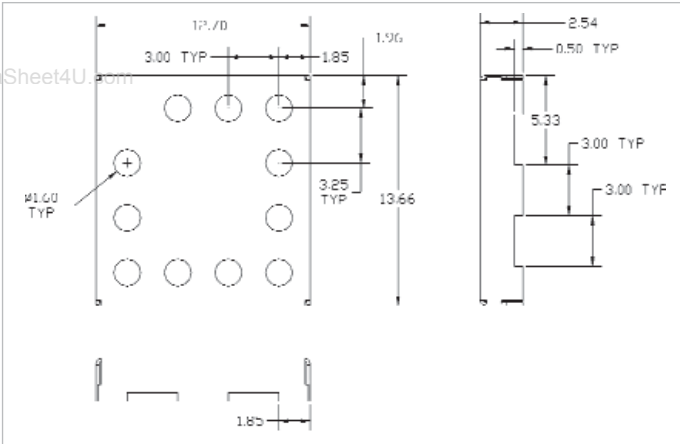

## STANDARD SURFACE MOUNT SHIELD TWO-PIECE PART NO. BMIS-201

### DESIGN SPECIFICATIONS

PART NUMBER	SURFACE AREA	MAXIMUM OVERALL DIMENSION	MAXIMUM OVERALL HEIGHT	CARRIER TAPE WIDTH	CARRIER TAPE PITCH	PARTS PER REEL
BMIS-201	253" (163.10")	.538 x .476 (13.66 x 12.10)	.100 (2.54)	24 mm	20 mm	1000

### APPLICATIONS:

- Works exceptionally well in small component areas
- 48 VQFP

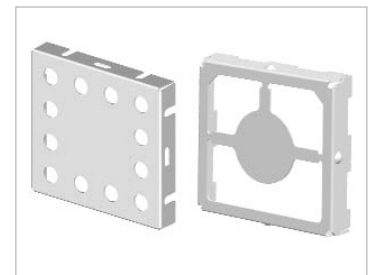

### Dimensions (mm)

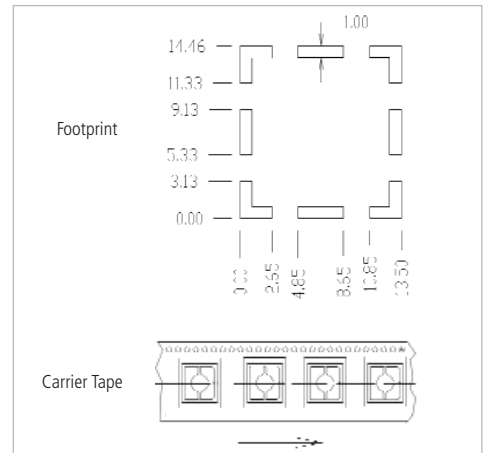
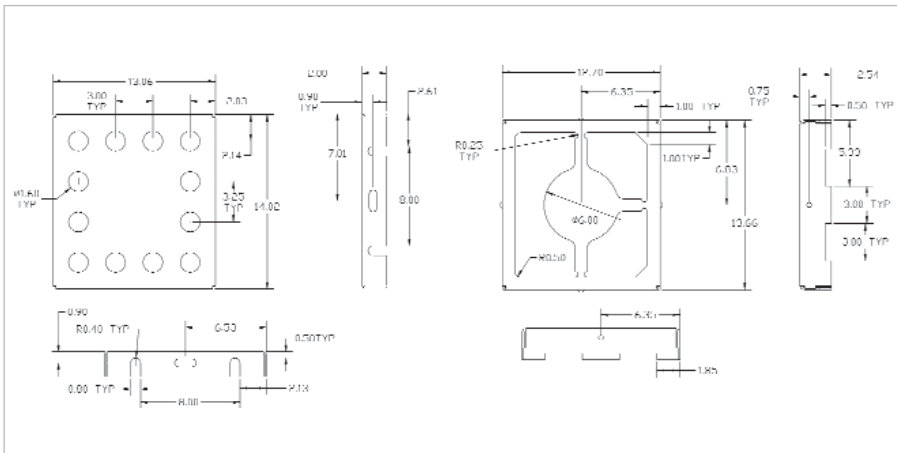

All dimensions shown are in millimeters unless otherwise specified.



## STANDARD SURFACE MOUNT SHIELD ONE-PIECE PART NO. BMIS-102

### DESIGN SPECIFICATIONS

PART NUMBER	SURFACE AREA	MAXIMUM OVERALL DIMENSION	MAXIMUM OVERALL HEIGHT	CARRIER TAPE WIDTH	CARRIER TAPE PITCH	PARTS PER REEL
BMIS-102	.402" (259.21 <sup>1</sup> )	.650 x .650 (16.50 x 16.50)	.142 (3.60)	32 mm	24 mm	700

### APPLICATIONS:

- 48 VQFP
- 44, 48 QFP

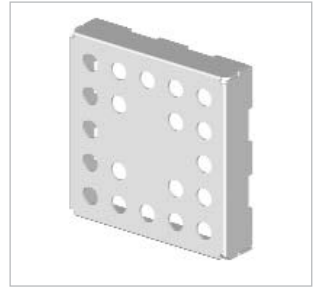

### Dimensions (mm)

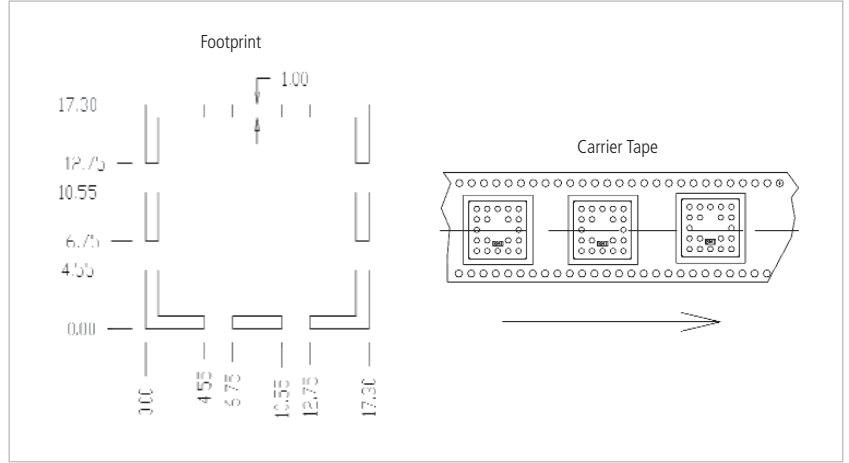
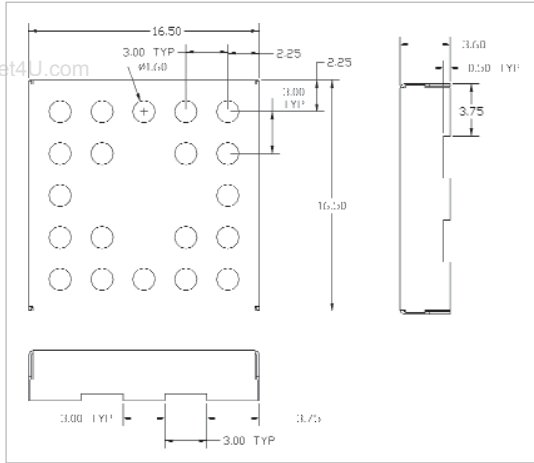

## STANDARD SURFACE MOUNT SHIELD TWO-PIECE PART NO. BMIS-202

### DESIGN SPECIFICATIONS

PART NUMBER	SURFACE AREA	MAXIMUM OVERALL DIMENSION	MAXIMUM OVERALL HEIGHT	CARRIER TAPE WIDTH	CARRIER TAPE PITCH	PARTS PER REEL
BMIS-202	.402" (259.21 <sup>1</sup> )	.650 x .650 (16.50 x 16.50)	.142 (3.60)	32 mm	24 mm	700

### APPLICATIONS:

- 48 VQFP
- 44, 48 QFP

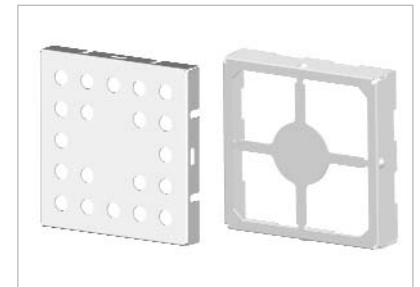

### Dimensions (mm)

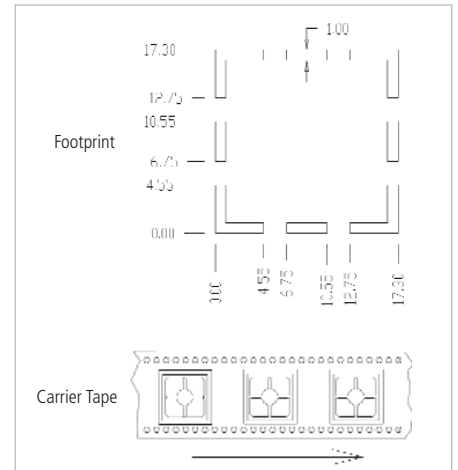
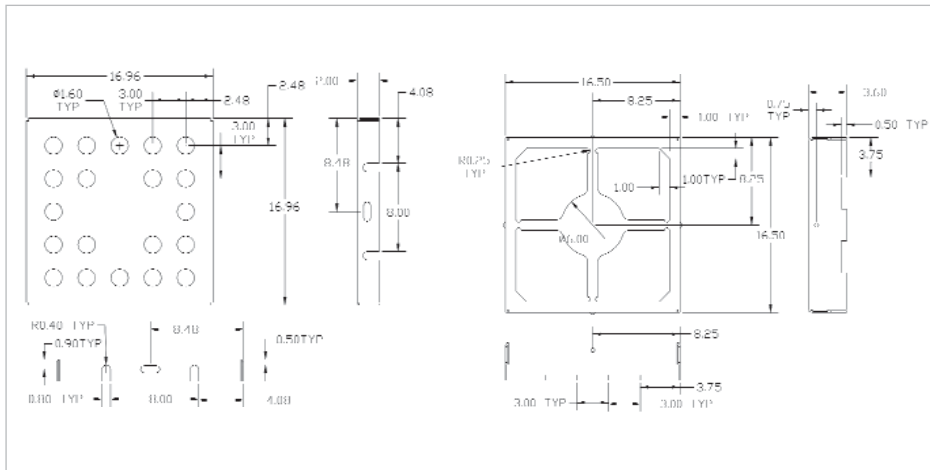

All dimensions shown are in millimeters unless otherwise specified.



## STANDARD SURFACE MOUNT SHIELD ONE-PIECE PART NO. BMIS-103

### DESIGN SPECIFICATIONS

PART NUMBER	SURFACE AREA	MAXIMUM OVERALL DIMENSION	MAXIMUM OVERALL HEIGHT	CARRIER TAPE WIDTH	CARRIER TAPE PITCH	PARTS PER REEL
BMIS-103	1.033" (666.16")	1.032 X 1.032 (26.21 X 26.21)	.200 (5.08)	44 mm	32 mm	300

### APPLICATIONS:

- 32, 44, 52 pin PLCC
- 121, 169 BGA
- 48, 100 VQFP
- 44, 48, 64, 80 QFP

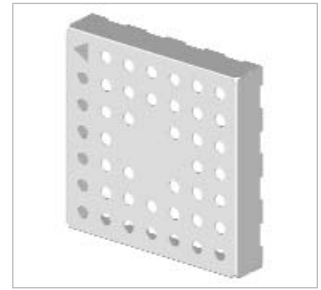

### Dimensions (mm)

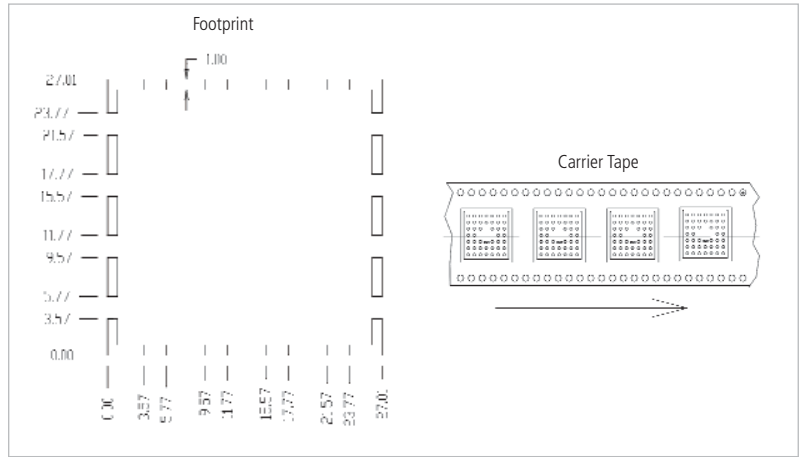
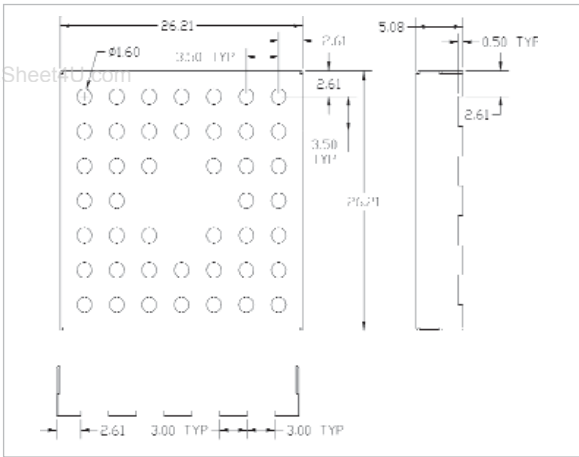

## STANDARD SURFACE MOUNT SHIELD TWO-PIECE PART NO. BMIS-203

### DESIGN SPECIFICATIONS

PART NUMBER	SURFACE AREA	MAXIMUM OVERALL DIMENSION	MAXIMUM OVERALL HEIGHT	CARRIER TAPE WIDTH	CARRIER TAPE PITCH	PARTS PER REEL
BMIS-203	1.033" (666.16")	1.032 X 1.032 (26.21 X 26.21)	.200 (5.08)	44 mm	32 mm	300

### APPLICATIONS:

- 32, 44, 52 pin PLCC
- 121, 169 BGA
- 48, 100 VQFP
- 44, 48, 64, 80 QFP

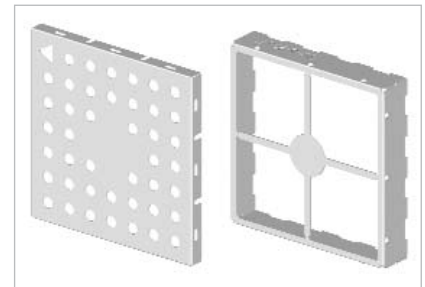

### Dimensions (mm)

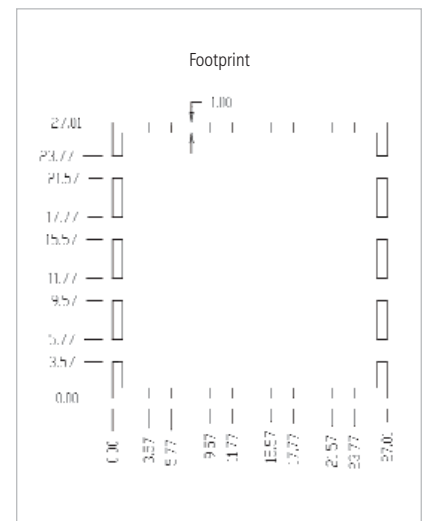
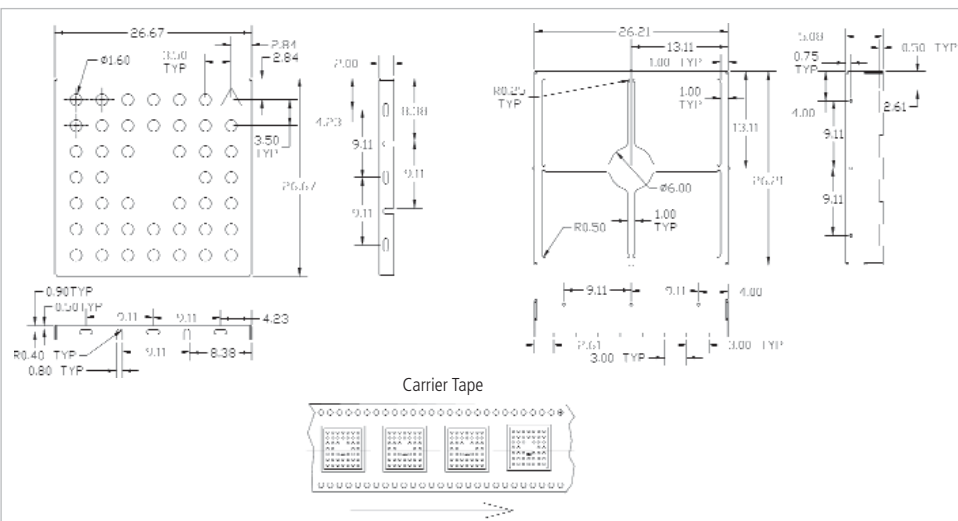

All dimensions shown are in millimeters unless otherwise specified.





# STANDARD DESIGN SHIELDS AND CONTACTS

## STANDARD SURFACE MOUNT SHIELD ONE-PIECE PART NO. BMIS-105

### DESIGN SPECIFICATIONS

PART NUMBER	SURFACE AREA	MAXIMUM OVERALL DIMENSION	MAXIMUM OVERALL HEIGHT	CARRIER TAPE WIDTH	CARRIER TAPE PITCH	PARTS PER REEL
BMIS-105	1.461" (942.50 <sup>2</sup> )	1.500 X 1.000 (38.10 x 25.40)	236 (6.00)	56 mm	32 mm	250

### APPLICATIONS:

- 121 BGA
- 32, 44, 52 PLCC
- 48, 100 VQFP
- 44, 48, 64, 80, 100 QFP

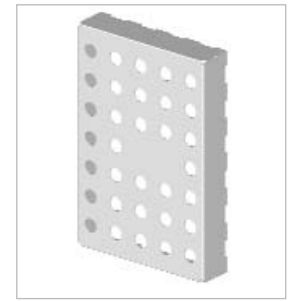

### Dimensions (mm)

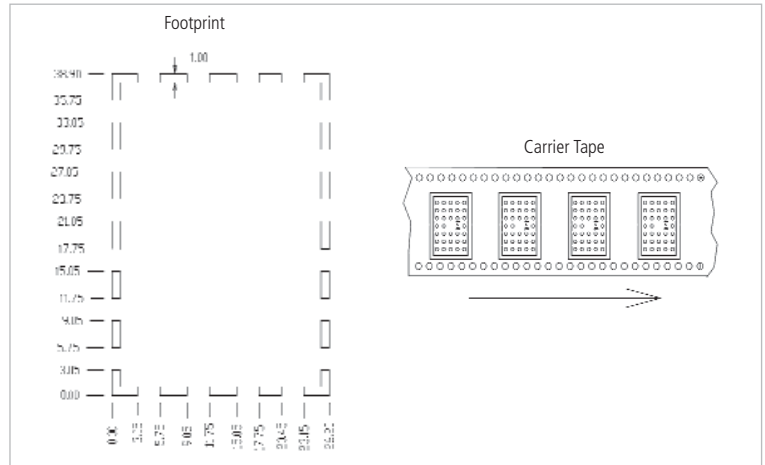
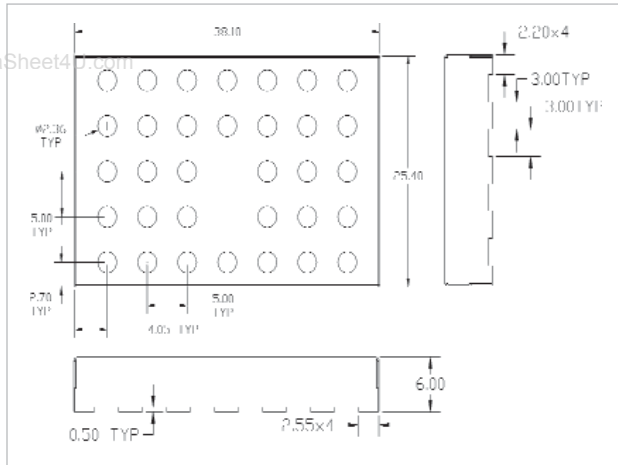

## STANDARD SURFACE MOUNT SHIELD TWO-PIECE PART NO. BMIS-205

### DESIGN SPECIFICATIONS

PART NUMBER	SURFACE AREA	MAXIMUM OVERALL DIMENSION	MAXIMUM OVERALL HEIGHT	CARRIER TAPE WIDTH	CARRIER TAPE PITCH	PARTS PER REEL
BMIS-205	1.461" (942.50 <sup>2</sup> )	1.500 X 1.000 (38.10 x 25.40)	236 (6.00)	56 mm	44 mm	250

### APPLICATIONS:

- 121 BGA
- 32, 44, 52 PLCC
- 48, 100 VQFP
- 44, 48, 64, 80, 100 QFP

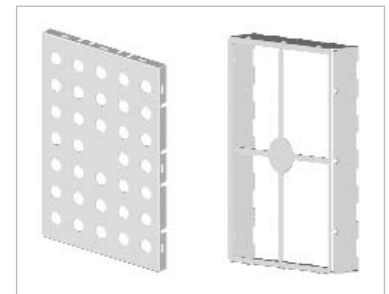

### Dimensions (mm)

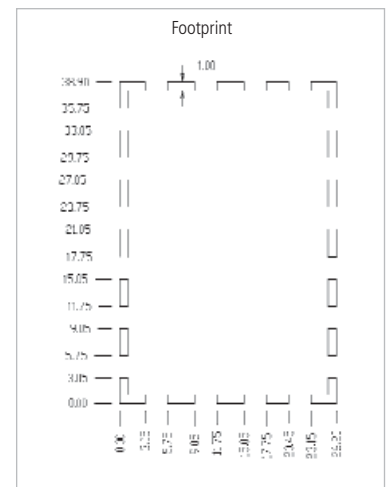
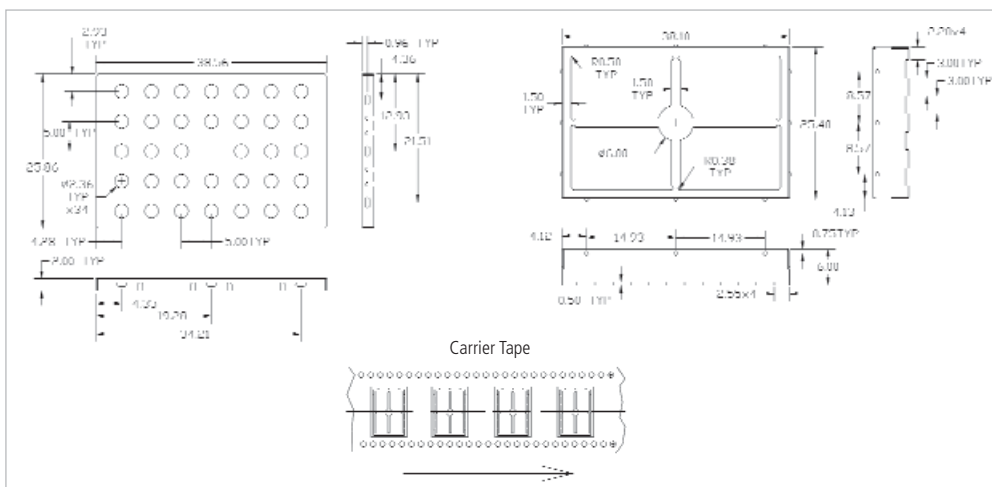

All dimensions shown are in millimeters unless otherwise specified.



## STANDARD SURFACE MOUNT SHIELD ONE-PIECE PART NO. BMIS-106

### DESIGN SPECIFICATIONS

PART NUMBER	SURFACE AREA	MAXIMUM OVERALL DIMENSION	MAXIMUM OVERALL HEIGHT	CARRIER TAPE WIDTH	CARRIER TAPE PITCH	PARTS PER REEL
BMIS-106	1.879" (1212.39")	1.450 X 1.326 (36.83 x 33.68)	.200 (5.08)	56 mm	40 mm	300

### APPLICATIONS:

- 121, 169, 225 BGA
- 32, 44, 52, 68 PLCC
- 48, 100 VQFP
- 44, 48, 64, 80, 100 QFP

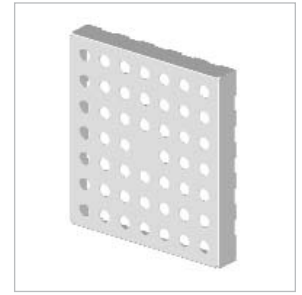

### Dimensions (mm)

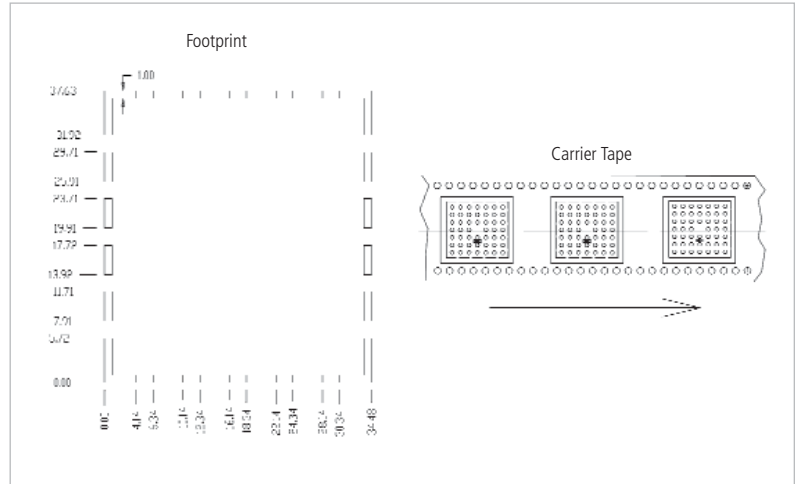
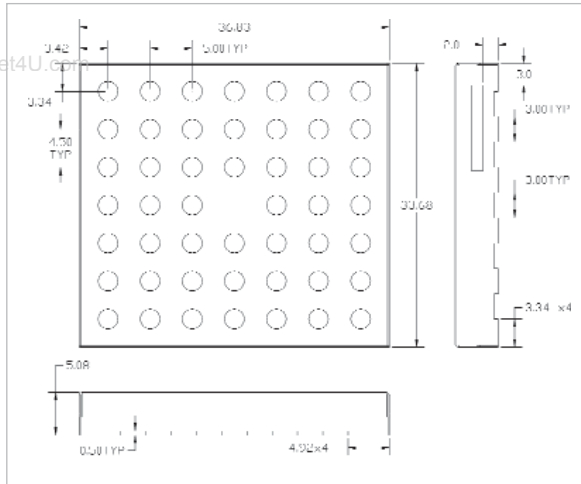

## STANDARD SURFACE MOUNT SHIELD TWO-PIECE PART NO. BMIS-206

### DESIGN SPECIFICATIONS

PART NUMBER	SURFACE AREA	MAXIMUM OVERALL DIMENSION	MAXIMUM OVERALL HEIGHT	CARRIER TAPE WIDTH	CARRIER TAPE PITCH	PARTS PER REEL
BMIS-206	1.879" (1212.39")	1.450 X 1.326 (36.83 x 33.68)	.200 (5.08)	56 mm	40 mm	300

### APPLICATIONS:

- 121, 169, 225 BGA
- 32, 44, 52, 68 PLCC
- 48, 100 VQFP
- 44, 48, 64, 80, 100 QFP

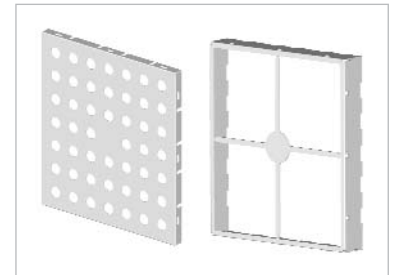

### Dimensions (mm)

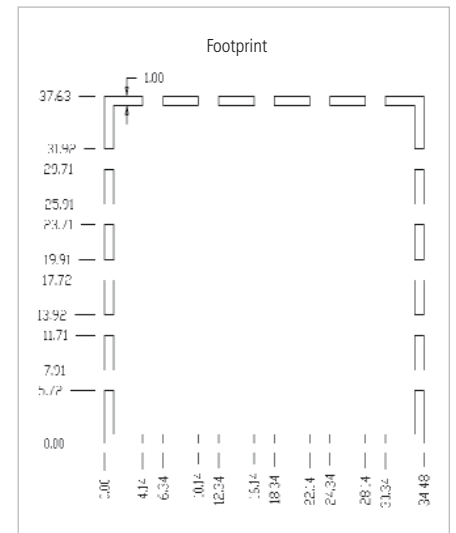
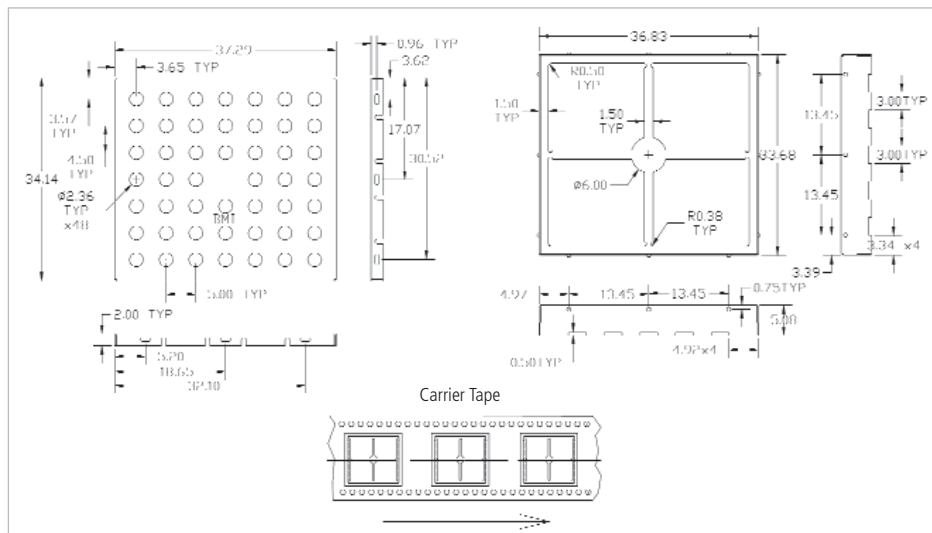

All dimensions shown are in millimeters unless otherwise specified.



## STANDARD SURFACE MOUNT SHIELD ONE-PIECE PART NO. BMIS-107

### DESIGN SPECIFICATIONS

PART NUMBER	SURFACE AREA	MAXIMUM OVERALL DIMENSION	MAXIMUM OVERALL HEIGHT	CARRIER TAPE WIDTH	CARRIER TAPE PITCH	PARTS PER REEL
BMIS-107	2.997" (1933.36")	1.747 X 1.747 (44.37 x 44.37)	.384 (9.75)	56 mm	56 mm	120

### APPLICATIONS:

- Supplied in 56 mm EIA standard carrier tape
- 121, 169, 225, 313 BGA
- 32, 44, 52, 68, 84 PLCC
- 48, 100, 208 VQFP
- 44, 48, 64, 80, 100, 120, 160 QFP

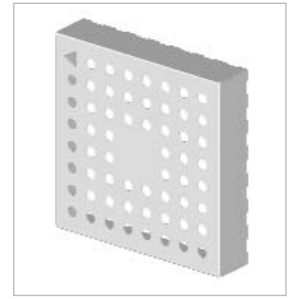

### Dimensions (mm)

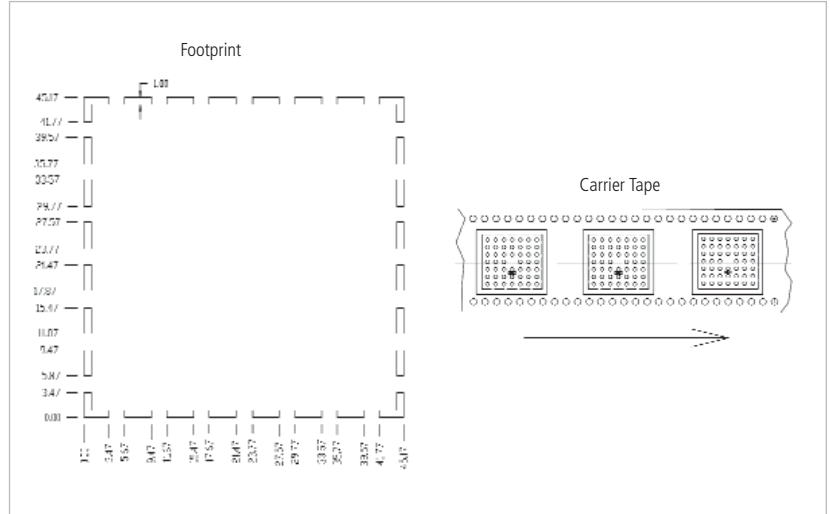
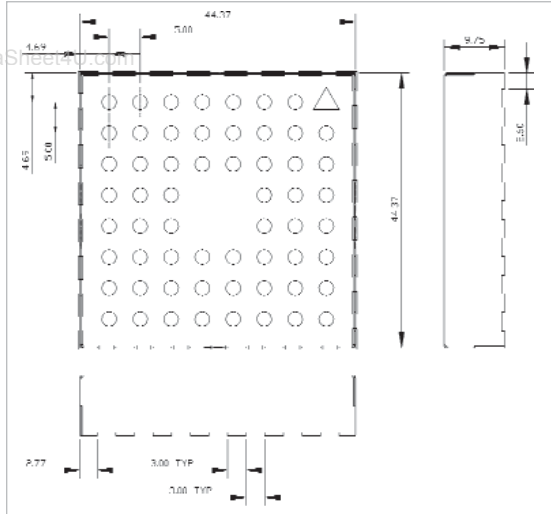

## STANDARD SURFACE MOUNT SHIELD TWO-PIECE PART NO. BMIS-207

### DESIGN SPECIFICATIONS

PART NUMBER	SURFACE AREA	MAXIMUM OVERALL DIMENSION	MAXIMUM OVERALL HEIGHT	CARRIER TAPE WIDTH	CARRIER TAPE PITCH	PARTS PER REEL
BMIS-207	2.997" (1933.36")	1.747 X 1.747 (44.37 x 44.37)	.384 (9.75)	56 mm	56 mm	120

### APPLICATIONS:

- 121, 169, 225, 313 BGA
- 32, 44, 52, 68, 84 PLCC
- 48, 100, 208 VQFP
- 44, 48, 64, 80, 100, 120, 160 QFP

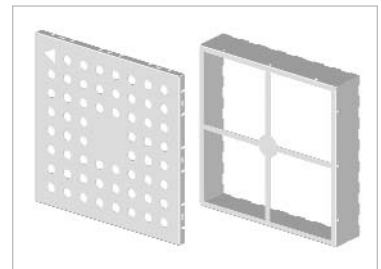

### Dimensions (mm)

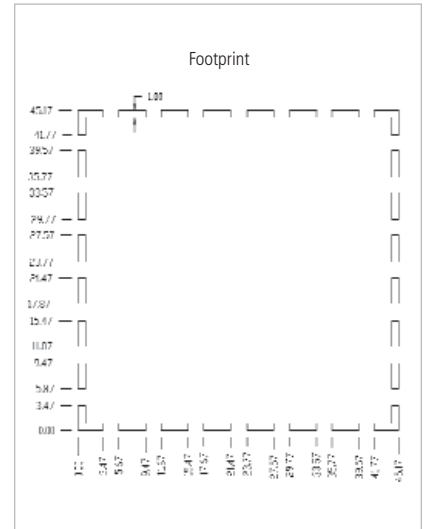
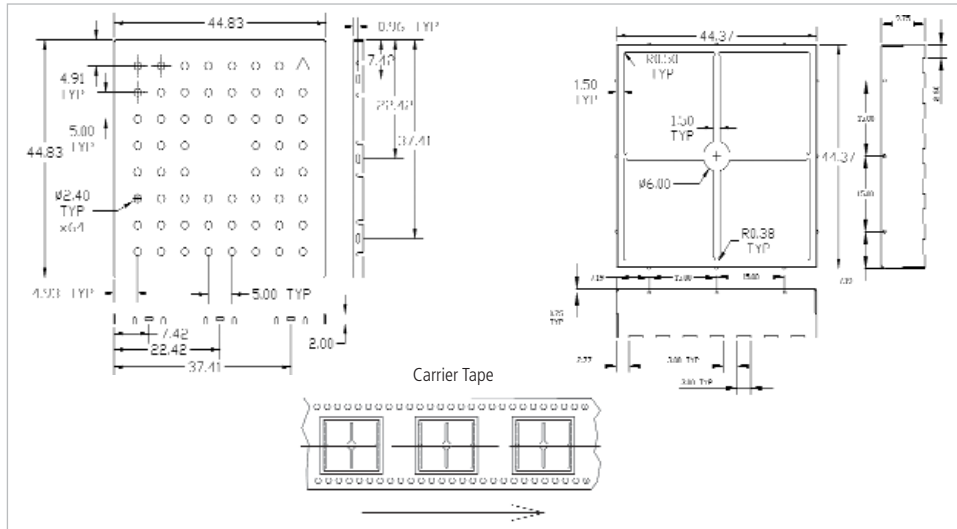

All dimensions shown are in millimeters unless otherwise specified.







## EZ PEEL™ STANDARD SHIELDS

### For Quick and Easy Access to Board Level Components

Laird Technologies offers four standard sizes of EZ Peel removable cover board level shields. These patented shields have a solid top, scored to allow peel-off when access to board level components within the shield is required.

The peel-off feature prevents damage to the board and components by eliminating the need for labor intensive de-soldering, which can often result in increased scrap. Peeling off the cover is accomplished by using a small starter hole for simple removal. This hand operation requires minimal force using a hook scribe or tweezers.

After repair, replacement or adjustment of internal components, the shield can be resealed using a replacement cover. Laird Technologies offers two replacement cover options: a snap-in cover and a dish cover.

The snap-in cover utilizes a lance and hole design. The replacement cover snaps into place and locks into a lance feature on the frame of the original shield.

The other option is a dish cover that gets soldered into place on the board. The dish shape allows for self-location of the cover for soldering.

All of our standard EZ Peel board level shields can be packaged in tape and reel formats for easy SMT installation using conventional pick-and-place equipment. The four standard sizes are also available without the EZ Peel (scored) feature.

- Easy removal of scored cover area
- Only 1.5 lbs. force for cover removal
- Simple replacement technique for cover
- Used on surface mount or through-hole applications
- Shield retains all physical properties after PCMCIA/ JEIDA testing for shock, bending, torque, drop and vibration
- CRS 1008/1010 (tin plated) for solderability

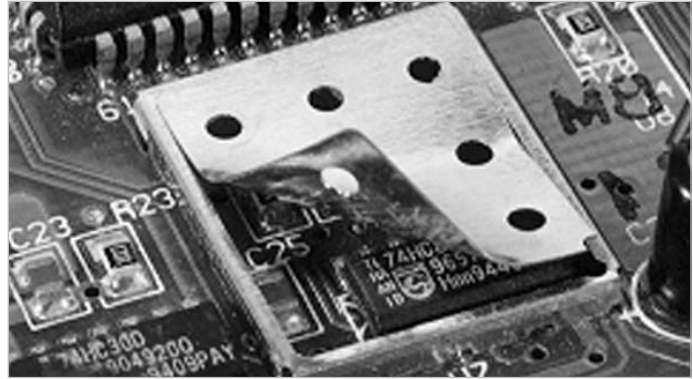
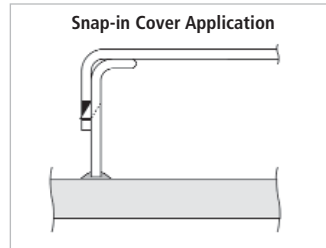
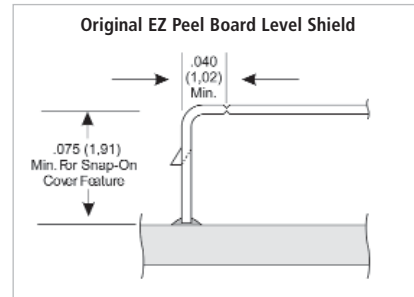
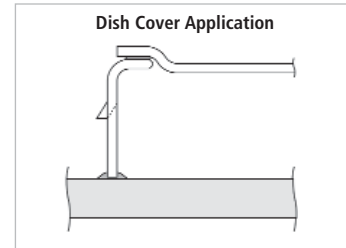

TABLE 1

EZ PEEL SHIELD PART NO.	REPLACEMENT LID OPTIONS	
	SNAP-IN LID NO.	DISH LID NO.
97-2002	97-2007	97-2014
97-2003	97-2006	97-2013
97-2004	Not Available	97-2016
97-2005	97-2008	97-2015



▲ After removal of scored section and application of snap-in cover



▲ After removal of scored section and application of dish cover

All dimensions shown are in (inches) millimeters unless otherwise specified.



## EZ PEEL™ STANDARD SHIELDS PROFILES/DIMENSIONS

EZ Peel Board Level Shields

Solder Pad Footprint

Carrier Tape

97-2002

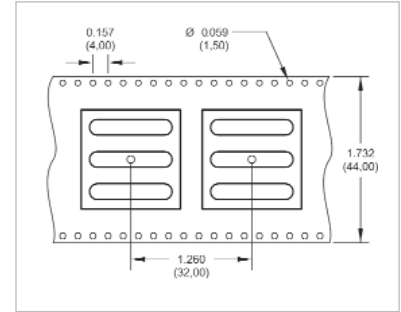
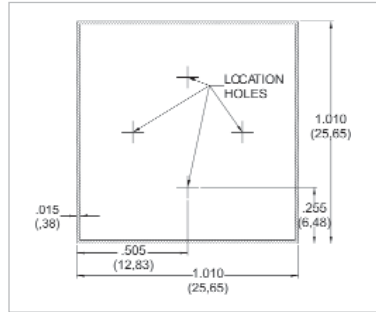
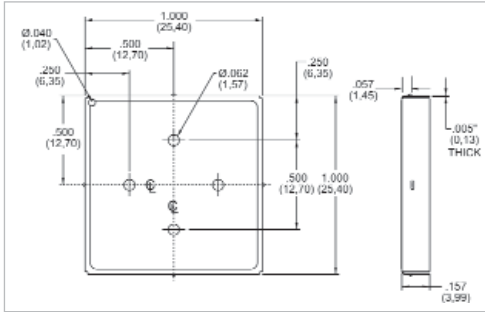

97-2003

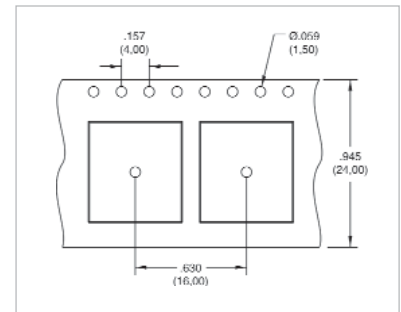
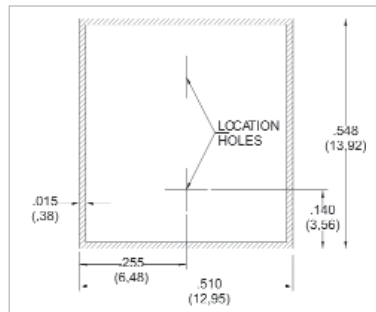
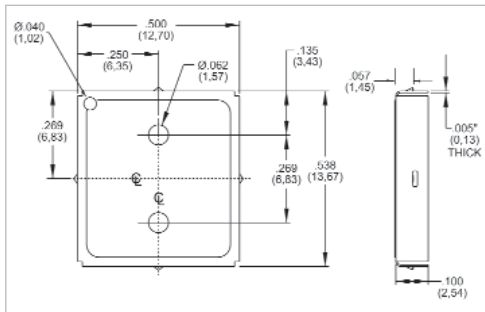

97-2004

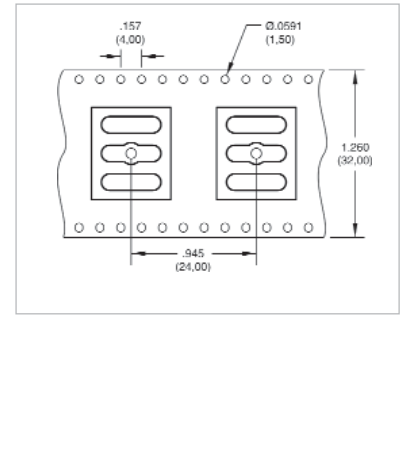
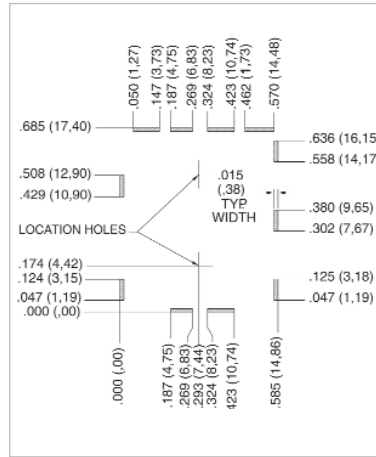
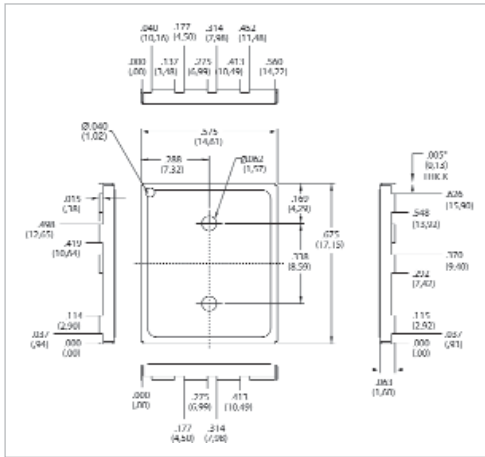

97-2005

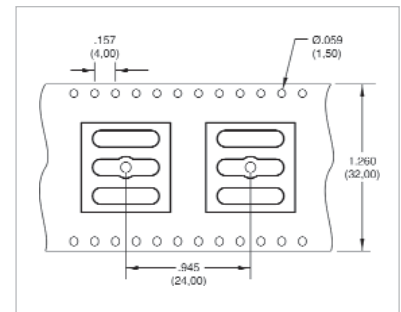
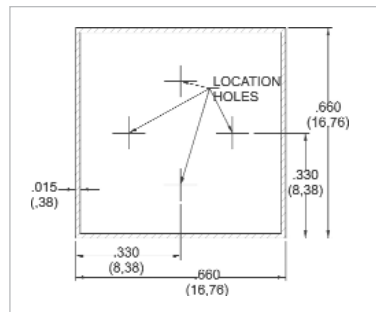
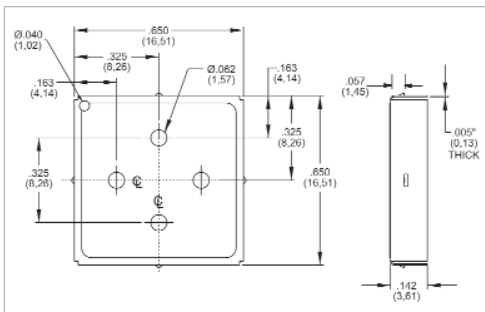

All dimensions shown are in (inches) millimeters unless otherwise specified.



# STANDARD DESIGN SHIELDS AND CONTACTS

## STANDARD PRECISION ELECTRONIC CONTACTS

Laird Technologies' standard precision electronic contacts ground, carry current and signals, and interconnect boards and devices. We offer a wide choice of plating options to allow for the maximum electrical current carrying performance. We have a wide array of designs in standard format that are ready for production. Installed costs are lowered with our tape and reel.

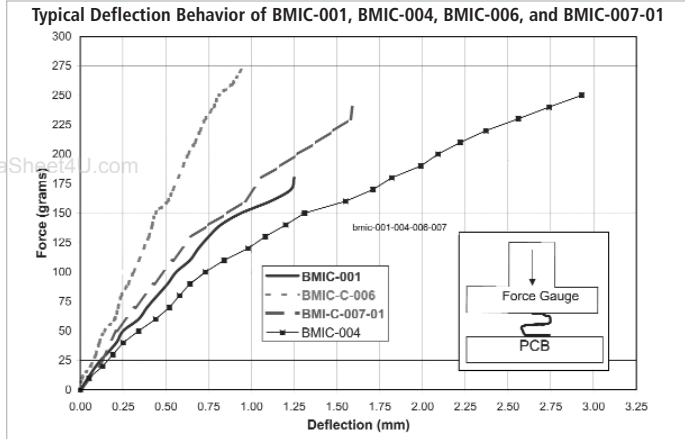

## STANDARD PRECISION ELECTRONIC CONTACTS MATERIAL VARIATIONS

CONTACTS	MATERIAL	AVAILABLE PLATINGS	TYPICAL APPLICATIONS	PARTS PER REEL
BMIC-001	0.10 mm BeCu	Nickel, tin, gold	Grounding, energy carrying	3000
BMIC-002	0.10 mm BeCu	Nickel, gold	Grounding, energy carrying	3500
BMIC-004	0.10 mm BeCu	Nickel, gold	Grounding, energy carrying	1400
BMIC-006	0.10 mm BeCu	Tin	Grounding, energy carrying	3500
BMIC-007-01	0.13 mm BeCu	Copper, tin	Grounding, energy carrying	2300
BMIC-010-*	0.20 mm Spring Steel	Tin	Standoff, support	3500

Material properties are for reference only. Product testing by purchaser is recommended to confirm. Laird Technologies assumes no liability for product failure unless specifically stated in writing.

### PART NO. BMIC-001

CONTACTS	MATERIAL	AVAILABLE PLATINGS	TYPICAL APPLICATIONS	PARTS PER REEL
BMIC-001	0.10 mm BeCu	Nickel, tin, gold	Grounding, energy carrying	3000

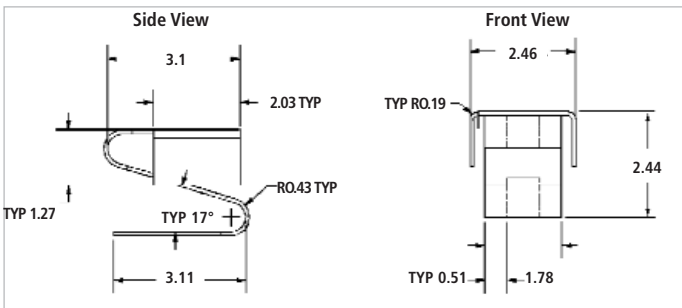

### PART NO. BMIC-002

CONTACTS	MATERIAL	AVAILABLE PLATINGS	TYPICAL APPLICATIONS	PARTS PER REEL
BMIC-002	0.10 BeCu	Nickel, gold	Grounding, energy carrying	3500

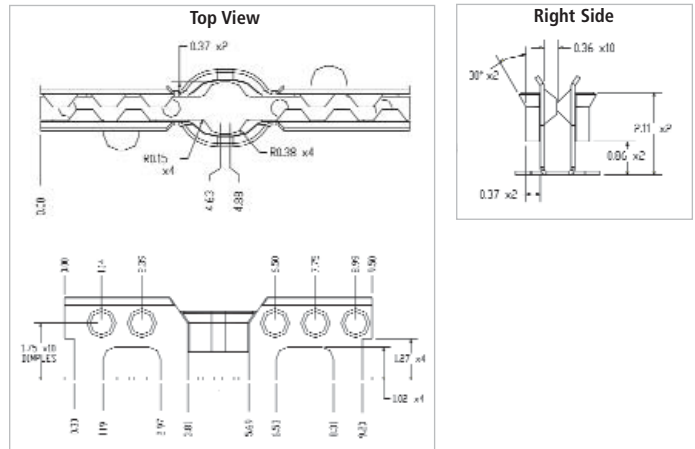

### PART NO. BMIC-004

CONTACTS	MATERIAL	AVAILABLE PLATINGS	TYPICAL APPLICATIONS	PARTS PER REEL
BMIC-004	0.10 mm BeCu	Nickel, gold	Grounding, energy carrying	1400

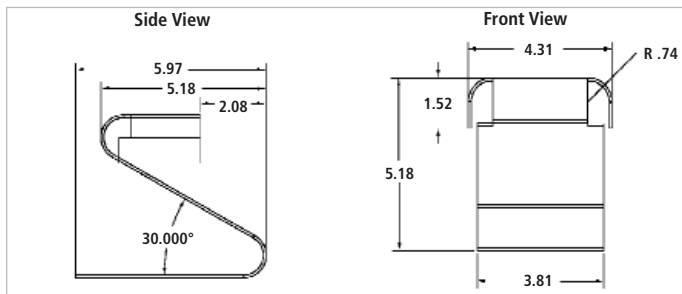

### PART NO. BMIC-006

CONTACTS	MATERIAL	AVAILABLE PLATINGS	TYPICAL APPLICATIONS	PARTS PER REEL
BMIC-006	0.10 BeCu	Tin	Grounding, energy carrying	3500

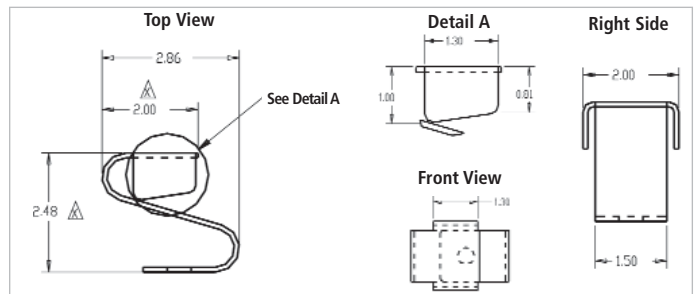

All dimensions shown are in millimeters unless otherwise specified.



## PART NO. BMIC-007-01

CONTACTS	MATERIAL	AVAILABLE PLATINGS	TYPICAL APPLICATIONS	PARTS PER REEL
BMIC-007-01	0.13 mm BeCu	Copper, tin	Grounding, energy carrying	2300

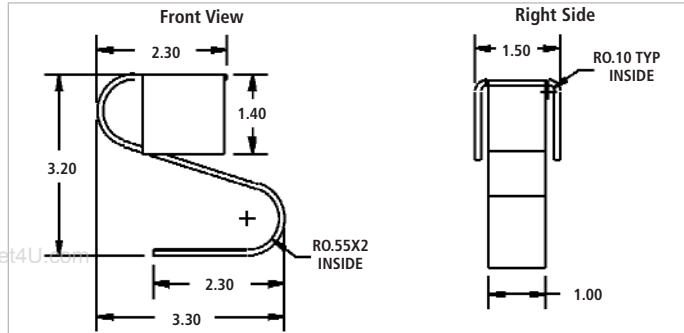

## PART NO. BMIC-010-\*

CONTACTS	MATERIAL	AVAILABLE PLATINGS	TYPICAL APPLICATIONS	PARTS PER REEL
BMIC-010-*	0.20 mm Spring Steel	Tin	Standoff, support	3500

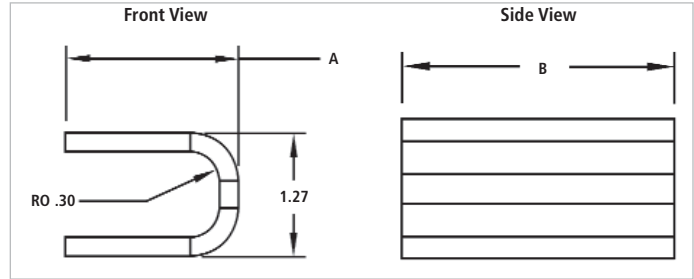

	A	B
*		
1	1.8	2.5
2	5.0	15.0
3	4.0	8.0



## STANDARD PROTOTYPE PARTS

Standard prototype parts are available in select one piece and two-piece sizes with no tooling fees. Parts are manufactured in our prototype department to production tolerances with lead times typically less than two weeks.

Shields are made from high quality steel for excellent shielding performance across a wide frequency range. The tin plated surface provides excellent solderability and compatibility with lead-free processes.

Upon request, part drawings and solder pad layouts are available.

### ONE PIECE

PART NUMBER	BLS TYPE	DIMENSIONS millimeters (inches)		
		LENGTH	WIDTH	HEIGHT
LT-BLS-109	1 piece BLS	5.08 (0.200)	3.05 (0.120)	1.52 (0.060)
LT-BLS-139	1 piece BLS	18.70 (0.736)	14.60 (0.575)	6.00 (0.236)
LT-BLS-137	1 piece BLS	30.30 (1.193)	14.80 (0.583)	6.00 (0.236)
LT-BLS-138	1 piece BLS	30.30 (1.193)	24.40 (0.961)	6.00 (0.236)
LT-BLS-141	1 piece BLS	34.20 (1.346)	14.60 (0.575)	6.00 (0.236)
LT-BLS-136	1 piece BLS	36.40 (1.433)	17.40 (0.685)	6.00 (0.236)
LT-BLS-143	1 piece BLS	39.40 (1.551)	35.30 (1.390)	6.00 (0.236)

All dimensions shown are in millimeters unless otherwise specified.

### TWO PIECE

PART NUMBER	BLS TYPE	DIMENSIONS millimeters (inches)		
		LENGTH	WIDTH	HEIGHT
LT-BLS-209	two piece	29.36 (1.156)	18.50 (0.728)	7.00 (0.276)
LT-BLS-215	two piece	33.02 (1.300)	27.05 (1.065)	10.16 (0.400)
LT-BLS-224	two piece	41.91 (1.650)	34.93 (1.375)	10.16 (0.400)
LT-BLS-216	two piece	44.96 (1.770)	27.05 (1.065)	10.16 (0.400)
LT-BLS-213	two piece	54.10 (2.130)	27.05 (1.065)	10.16 (0.400)
LT-BLS-225	two piece	57.15 (2.250)	34.93 (1.375)	10.16 (0.400)
LT-BLS-219	two piece	70.00 (2.756)	56.90 (2.240)	10.16 (0.400)
LT-BLS-229	two piece	70.49 (2.775)	42.80 (1.685)	10.16 (0.400)
LT-BLS-226	two piece	71.12 (2.800)	34.93 (1.375)	10.16 (0.400)
LT-BLS-227	two piece	85.73 (3.375)	34.93 (1.375)	10.16 (0.400)

On two piece BLS, dimensions shown are the exterior frame dimensions.



## INTRODUCTION

The complexities of today's electronics pose several design challenges. Resolving EMI needs to be balanced with space, weight and production restraints. When designing a custom shielding solution, beginning in the earliest stages of the application design allows you to effectively eliminate EMI and meet all specifications.

Laird Technologies board level shielding experts work with you through all phases of development. From design, rapid prototyping and pre-production through production and automated packaging, we have the experience to help speed your product to market and within budget.

To increase manufacturing throughput and reduce costs, we have developed a proprietary in-line production process that includes part formation, wash, assembly, inspection and automated packaging.

By integrating quality processes, we ensure board level shield quality and performance from the part design stage through final packaging. One such process is our automated co-planarity inspection system. We replicate the customer application by measuring shields in the same plane as the printed circuit board. This is accomplished without "securing" or "touching" shields, which could throw off measurement and/or deform parts. We measure shields immediately prior to placement into carrier tape at speeds that match automation packing.

Shield base materials include our exclusive Shield-Lite™, CRS 1008/1010, beryllium-copper alloys, nickel-silver alloys, copper-based alloys and spring steels. All shields are fully solderable.

## SURFACE MOUNT SHIELDS MATERIAL VARIATIONS

RAW MATERIAL*	THICKNESS IN (mm)	HEAT TREATMENT	PLATING	COMMENTS
CRS base box steel 1008/1010	.005 to .090 (0.127 to 2.286)	No heat treatment	Tin	Pre-plated
Beryllium-copper alloys	.004 to .008 (0.102 to 0.203)	Heat treatable in all tempers	Tin, palladium, nickel, gold	Pre-tempered & pre-plated
Nickel-silver alloys	.004 to .016 (0.127 to 0.406)	Stress annealed	Fully solderable (if used with LT proprietary process)	No plating required for SMT solderability
Copper-based alloys	.004 to .012 (0.102 to 0.305)	No heat treatment	Tin, palladium, nickel, gold	Pre-tempered & pre-plated
Spring steel	.006 to .060 (0.152 to 1.524)	Austemper	Tin, nickel, black oxide	Spring properties determined by application
Shield-Lite™	0.005 (0.13)	N/A	1.25-5.00mm 100% matte tin	Fully Solderable
Phosphor Bronze alloys	.004 to .020 (0.10 to 0.51)	N/A	Tin, palladium nickel, gold	Pre-tempered & Pre-plated

\*Other materials may be available, please consult sales.

Material properties are for reference only. Product testing by purchaser is recommended to confirm. Laird Technologies assumes no liability for product failure unless specifically stated in writing.

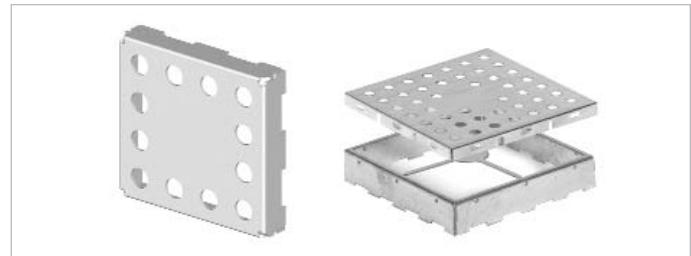

## ONE-PIECE SHIELD DESIGN Low Cost/Excellent Effectiveness

Custom surface mount shields are available in both one-piece and two-piece designs. One-piece shields provide six sides of protection, with the sixth side being the board itself. One-piece designs offer economical shielding alternatives where access to covered components for repair is not necessary. For our standard one-piece shields see pages 8-14.

## TWO-PIECE SHIELD DESIGN Quick, Easy Repair and Inspection of Covered Components

Two-piece board level shields offer users the flexibility to inspect or repair shielded components without having to risk board damage by removing the entire shield. Covers snap on and off with ease, making repairs quicker and easier, and reducing board re-work. Two-piece shields are available pre-assembled or unassembled. For our standard two-piece shields see pages 8-15.

Large locking dimples snap into slots on covers to provide mechanical retention force. Smaller grounding dimples provide electrical grounding for proper shielding and to prevent rattle. We have designed our two-piece shields to survive drop, shock and no-rattle tests. Here are critical test results:

- Able to withstand acceleration of 4g from 10 Hz to 2000 Hz for three hours in each of three planes as per SAE J1455
- Passed EN 50 155 for railway electrical equipment including vibration test of 30g from 5 Hz to 200 Hz in 3 directions and a shock test with 500 m/s for 11 ms
- Passed standard telecommunications drop tests [6 faces, dropped 1 meter onto concrete floor]

All dimensions shown are in inches (millimeters) unless otherwise specified.

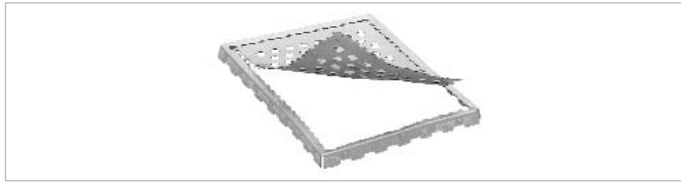

## EZ PEEL™ SHIELD DESIGN

### Economical Access for Low Incidences of Repairs

In cases where there is a low incidence of repairable circuit defects, you may need to access shielded components. An economical solution is our line of EZ Peel shields. These one-piece shields feature an easy-to-remove top section that can be peeled back using simple tools for access to components. Built-in flexibility controls the ease of removing the top, and our robust design delivers superior flatness. EZ Peel shields are designed to accept a snap-on cover in the same manner as our two-piece shields, following circuit repair. For our standard EZ Peel products see pages 16-17.



## MULTI-COMPARTMENTAL SHIELD DESIGN

### Shield Multiple Circuit Groups—Save PCB Space and Production Time

Printed circuit boards with multiple circuit groups pose unique design challenges. Shielding these groups separately adversely affects circuit board real estate and increases part count. Our multi-compartmental shields allow you to replace three or more single shields with one shield divided into several walled compartments. Installing a single part reduces part count, along with production time through faster pick-and-place speeds. This allows you to reduce the number of parts you carry in inventory, which lowers your overhead costs.

Multi-compartmental shields feature internal dividing walls of one material thickness and meet all on-board shield requirements for FCC, VDE, CISPR and CE. They are available in two-piece designs, either assembled or unassembled. Our unassembled versions allow for automatic optical inspection prior to cover placement. As in all our shielding offerings, Laird Technologies' proprietary process for 100% automatic optical inspection verifies co-planarity—including inner walls.



## SHIELD-LITE™

### Lightweight, Solderable Shielding Solution

Laird Technologies' Shield-Lite is the lightest-weight shielding solution on the market. Our proprietary engineered aluminum-based alloy weighs less than 50% of conventional materials, yet delivers enhanced shielding performance. Shield-Lite is fully solderable and will not warp during re-flow.

The thermal conductivity of Shield-Lite delivers a 192% improvement over steel. The increased thermal conductivity allows heat to be more efficiently transferred to the solder pad trace during the re-flow process. Additionally,

heat generated by shielded devices is more effectively dispersed, allowing operation at faster clock speeds.

Shield-Lite is available in one-piece or EZ Peel configurations for any application where light weight is critical.

### SHIELD-LITE DESIGN PARAMETERS

MATERIAL	MATERIAL DENSITY	AVAILABLE MATERIAL GAUGE	CORE MATERIAL	SOLDERABILITY
LT-BLS-Shield-Lite	3.3 g/cc (58% lighter than standard material)	0.13 - 1.38 mm	Aluminum	ANSI / J STD-002: Pass ANSI / EIA 638: Pass
SOLDERABLE MATERIAL	PLATING THICKNESS	ADHESION	ELECTRICAL CONDUCTIVITY	THERMAL CONDUCTIVITY
100% matte tin	2.5 - 5.0 microns	Passes ASTM B-571	>45% IACS (4 times more conductive than standard material)	190 W/m-K (2.9 times more than standard material—192% improvement)
DESIGN AVAILABILITY	TENSILE STRENGTH	YIELD STRENGTH	ELONGATION	
One-piece EZ Peel	227-277 MPa (33-40 ksi)	206-262 MPa (30-38 ksi)	1-3%	

Material properties are for reference only. Product testing by purchaser is recommended to confirm. Laird Technologies assumes no liability for product failure unless specifically stated in writing.



## INSULSHIELD™

### Reduce the Cost of Protecting Components

Because EMI shields are made of conductive materials, there is the possibility that they could short-circuit other board components. Traditionally, protective polyester tapes or polyimide films have been used to isolate shields. However, these methods add steps and additional expense to the production process, which results in higher costs and added production time.

Laird Technologies' exclusive InsulShield, available in one-piece, two-piece or multi-compartmental shields, offers a better alternative. The coating used is 15–30 µm thick, which is thinner than isolating tapes, therefore requiring less space. Eliminating tapes also means fewer production steps and lower inventory costs. InsulShield offers excellent aging properties and abrasion resistance. This leads to a longer life of your end product. InsulShield meets several ASTM standards including ASTM D-523, D-3363, D-4060, D-2714, B-117, G-85, D-2510A and D-2510C. InsulShield is fully compatible with standard re-flow processes.

### INSULSHIELD DESIGN PARAMETERS

AVAILABLE MATERIAL THICKNESS ELECTRICAL: DIALECTRIC BREAKDOWN STRENGTH	COATING AGING	CORROSION RESISTANCE	HUMIDITY
15 - 30 microns >250V/mil	Survives QUV UVB test	ASTM B-117 >1500 hours ASTM G-85 >600 hours	Survives 85%/85°C humidity >100 hours without degradation
REFLOW	COLOR	ADHESION	PENCIL HARDNESS (ASTM D-3363)
No degradation during reflow	16 colors (black is standard)	Passes ASTM B-571	ASTM D-3363: 4H
ABRASION	DESIGN AVAILABILITY	SERVICE TEMPERATURE	
ASTMD-4060: 2.2mg wght loss/1000 cycles ASTMD-2714: 125,000 cycles ASTMD-2714: 0.07	One-piece Two-piece Multi-compartmental	-73°C to 205°C	

Material properties are for reference only. Product testing by purchaser is recommended to confirm. Laird Technologies assumes no liability for product failure unless specifically stated in writing.



## DRAWN BOARD LEVEL SHIELDS

### Seamless Corners Address High-Frequency Leakage

As microprocessor speeds continue to increase, so does the potential for EMI leakage through the smallest apertures in board level shields. Laird Technologies' drawn board level shields are designed to provide additional near-field and far-field circuit isolation (attenuation) at higher frequencies by eliminating the apertures found in the corners of traditional board level shields. Drawn board level shields utilize small ground trace sizes, thereby preserving space on the circuit board.

- Solid corner designs when additional circuit isolation (attenuation) is required at higher frequencies
- Available in heights up to .250" (6.4 mm) with length and width dimensions from .300" (7.6 mm) to 2.0" (50.8 mm)
- Tape and reel packaging provides an economical and automated SMT attachment method
- Available in cold rolled steel, brass, stainless steel and nickel silver
- Mold-in-place and form-in-place elastomers can be combined with drawn board level shields to achieve shielding of multiple components with a single part
- Available with an EZ Peel™ scored cover feature; allows for easy top section removal for component repair and re-sealing
- Ventilation holes as needed for solder outgassing.

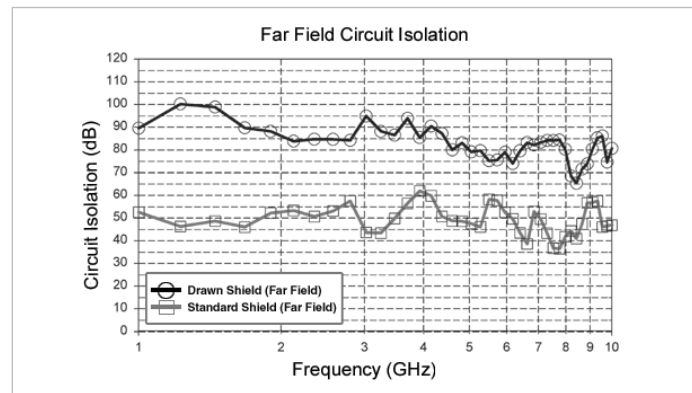
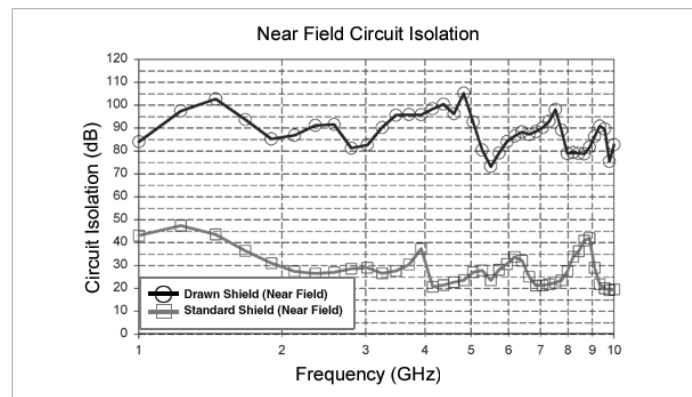
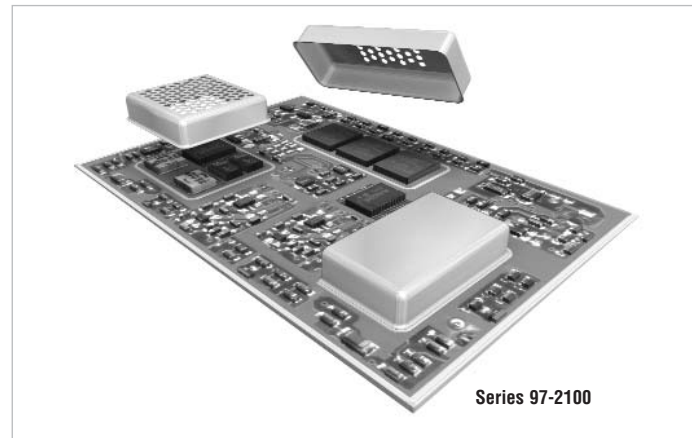

^ The receive antenna test region from 1 GHz to 10 GHz that defines the Far-Field and Near-Field is 2.0" and 0.190", respectively, from the transmit antenna. This test is performed for worst case orientation.

Circuit Isolation is a measurement that defines the resultant attenuation level in dB provided by a PCB shield from an initial reference level as defined in Laird test procedure PDA-PRO-027.

Notice: The data set forth in all text, tables, charts, graphs and figures herein are based on samples tested and are not guaranteed for all samples or applications. Such data are intended as guides and do not reflect product specification for any specific part.

All dimensions shown are in inches (millimeters) unless otherwise specified.





## DYNA-FORM

Laird Technologies remains at the forefront of stamping technology. We offer innovative solutions for Board Level Shields (BLS). Our two piece BLS design allows convenient access when the enclosed circuitry must be repaired. Covers snap on and off with ease, which makes repair of the component under the shield quicker and easier. Previously, two pieces of the BLS assembly [frame and lid] were assembled with specialized automation equipment.

Dyna-Form eliminates the need for specialized automation equipment. The parts are formed and assembled in one dynamic operation using the latest stamping technology. The need for supporting ribs on the frame is eliminated. Each custom designed solution can be specifically tailored to specific circuitry geometry.

### Dyna-Form Advantages

- Lowers overall tooling cost by eliminating the need for specialized automation tooling.
- Reduces lead time by eliminating the need for specialized automation tooling.
- Improved lid retention forces.
- Improved time to market.
- Reduces required PCB space because there is no gap between frame and cover.
- Increased access, no cross bars needed.

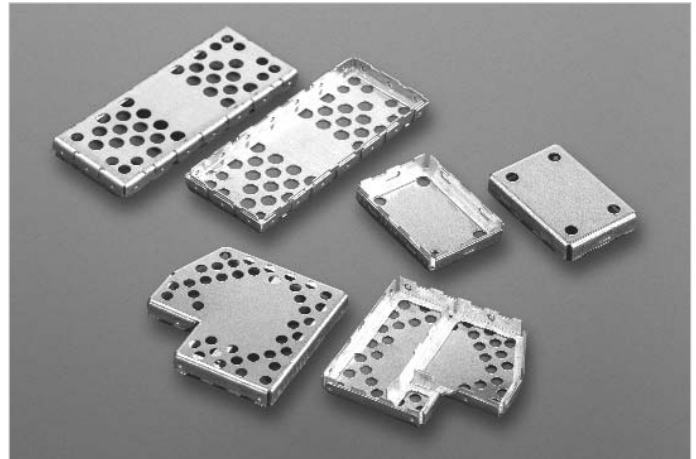



## CUSTOM PRECISION ELECTRONIC CONTACTS Gain Maximum Electrical and Carrying Performance

From concept to placement, Laird Technologies has the expertise to deliver custom precision surface mount contacts. Using the latest computer simulation techniques, we provide properly designed contacts that ground, carry current and signals, and interconnect boards and devices. We do this by using basic geometric parameters (length, width, uncompressed height, compressed height, contact force) to conduct Finite Element Analysis (FEA) on your prospective design. With the FEA results, we can then identify the best design to optimize your product's operational performance. We also incorporate features to provide for placement and soldering of the contact onto the circuit board.

Laird Technologies offers a wide range of plating options to allow for maximum electrical current carrying performance. We have exclusive processes such as our innovative Mako process, which selectively plates contacts with precious metals only in the necessary areas. This eliminates bare edges and reduces costs.

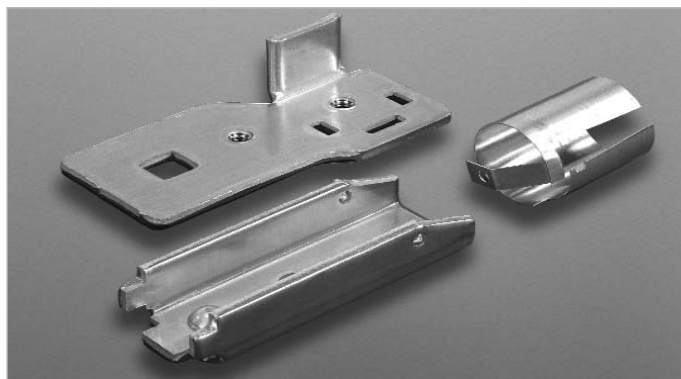

Our automated packaging allows for complex and small designs with lower installed costs.

Contact base materials include beryllium-copper, phosphor bronze, nickel and stainless steel. All contacts are fully solderable as required.

## CUSTOM PRECISION ELECTRONIC CONTACTS MATERIAL VARIATIONS

TYPE	THICKNESS in (mm)	HEAT TREATMENT	PLATING / COATING	COMMENTS
Beryllium Copper Alloys: 17200, 190, 290, 174	.0035 to .080 (0.089 to 2.03)	Heat Treatable	Tin, palladium, nickel, gold, silver	Heat Treated as Necessary. Pre-Plated or Post-Plated
Phosphor Bronze Alloys: 510, 505, 511, 521, 544	.004 to .090 (0.10 to 2.29)	N/A	Tin, palladium, nickel, gold, silver	Pre-Plated or Post-Plated
Copper Alloys: 110, 102, 122, 1093	.006 to .125 (0.15 to 3.18)	N/A	Tin, palladium, nickel, gold, silver	Pre-Plated or Post-Plated
Brass Alloys: 260, 210, 220, 226, 230, 240, 268, 350, 353	.004 to .090 (0.10 to 2.29)	N/A	Tin, palladium, nickel, gold, silver	Pre-Plated or Post-Plated
Nickel Silver Alloys: 770, 752, 762	.004 to .060 (0.10 to 1.52)	N/A	Tin, palladium, nickel, gold, silver	Solderable in unplated condition (if used with LT proprietary process)
Spring Steel Alloys: 1050, 1065, 1074, 1095	.008 to .080 (0.20 to 2.03)	Austemper	Tin, nickel, black oxide	Plated after heat treatment.
Stainless Steel Alloys: 301, 302, 305, 316, 201, 202	.004 to .090 (0.10 to 2.29)	N/A	Tin, gold	Pre-Plated or Post-Plated
Stainless Steel Alloys: 410, 420	.004 to .090 (0.10 to 2.29)	Heat treatable	Tin, gold	Heat Treated as Necessary. Pre-Plated or Post-Plated
Titanium Copper	.004 to .012 (0.10 to 0.30)	N/A	Tin, palladium, nickel, gold, silver	Heat Treated as Necessary. Pre-Plated or Post-Plated
Special Alloys: Clad metals	.0035 to .080 (0.089 to 2.03)	N/A	Tin, palladium, nickel, gold, silver, palladium-silver	Pre-plated or Post-Plated
Post Plating	Thickness as required	N/A	Tin, nickel, gold, silver, zinc, black oxide, black zinc, phosphate	N/A

Additional material choices are available upon request. Material properties are for reference only. Product testing by purchaser is recommended to confirm. Laird Technologies assumes no liability for product failure unless specifically stated in writing.

All dimensions shown are in inches (millimeters) unless otherwise specified.



[www.DataSheet4U.com](http://www.DataSheet4U.com)

## NORTH AMERICA

Our USA toll-free telephone number is  
+1.800.843.4556

### Delaware Water Gap, USA

P.O. Box 650 Shielding Way  
Delaware Water Gap, PA 18327  
Phone +1.570.424.8510  
Fax +1.570.424.6213

### St. Louis, USA

3481 Rider Trail South  
St. Louis, MO 63045  
Phone +1.314.344.9300  
Fax +1.314.344.9333

### San Jose, USA

2030 Fortune Drive  
Suite 100  
San Jose, CA 95131  
Phone +1.408.544.9500  
Fax +1.408.577.0691

### San Marcos, USA

1825 Diamond St.  
San Marcos, CA 92069  
Phone +1.760.736.7007  
Fax +1.760.736.7008

### Schaumburg, USA

1751 Wilkening Ct.  
Schaumburg, IL 60173  
Phone +1.847.839.6000  
Fax +1.847.519.9682

## EUROPE

### Rosenheim, Germany

Äußere Oberaustraße 22  
83026  
Rosenheim, Germany  
Phone +49.8031.24600  
Fax +49.8031.246050

### France

13-15 rue des Entrepreneurs  
91560 Crosne, France  
Phone +33.1.69.49.79.79  
Fax +33.1.69.49.79.80

### Czech Republic

Prumyslova 497  
462 11 Liberec  
Czech Republic  
Phone +420.488.575.111  
Fax +420.488.575.303

### United Kingdom

Warner Drive  
Springwood Industrial Estate  
Braintree  
Essex CM7 2YW  
Phone +44.1376.342626  
Fax +44.1376.346442

## ASIA

### Taiwan

4F, No. 6, Hou-Sheng Rd.  
Luchu, Taoyuan, Taiwan 338  
Phone +886.3.312.9292  
Fax +886.3.312.9090

### Japan

Shin Yokohama Business Center Building 7F  
2-6, Shin Yokohama 3-chome,  
Kohoku-ku, Yokohama-shi,  
Kanagawa 222-0033, Japan  
Phone +81.45.473.6808  
Fax +81.45.473.6162

2-12-8 Sachiura, Kanazawa-ku  
Yokohama-shi 236-0003, Japan  
Phone +81.457.851063  
Fax +81.457.851064

### Shenzhen, China

No. 2 Building, 2nd Industry Park,  
Tangxiayong Songgang Town,  
Baoan District, Shenzhen City,  
Guangdong Province,  
China 518105  
Phone +86.755.271.41166  
Fax +86.755.271.41199

### Tianjin, China

Building B, Fenghua Industrial Park,  
66 on the Ninth Avenue, TEDA,  
Tianjin, P.R. China 300457  
Phone +86.22.6629.8160  
Fax +86.22.6629.8158

### Shanghai, China

Building 1, Number 58  
Hua Ning Road, Lane 4018  
Shanghai, P.R. China 201108  
Phone +86.21.6442.8018  
Fax +86.21.6489.6055

### Suzhou, China

Room 408, 4th Floor, Suzhou Tohkin Plaza,  
889 Ganjiang Road,  
Suzhou City, Jiangsu Province,  
P.R. China 215002  
Phone +86.512.651.51368  
Fax +86.512.651.56878

### Singapore

750E Chai Chee Road #03-07/08  
Technopark@Chai Chee  
Singapore 469005  
Phone +65.6243.8022  
Fax +65.6243.8021

### Korea

2nd Floor, Hwasung Bldg.  
34-2 Chunho-dong,  
Kangdong-ku, Seoul, Korea  
Phone +82.2477.1390  
Fax +82.2477.1393

NOTICE: Although the information and recommendations set forth herein (hereinafter "information") are presented in good faith and believed to be correct as of the date hereof, Laird Technologies makes no representation or warranties as to the completeness or accuracy thereof. Information is supplied upon the condition that the persons receiving same will make their own determination as to its suitability for their purposes prior to use. In no event will Laird Technologies be responsible for damages of any nature whatsoever resulting from the use or reliance upon information or the product to which information refers. Nothing contained herein is to be construed as a recommendation to use any product, process, equipment or formulation in conflict with any patent, and Laird Technologies makes no representation or

warranty, expressed or implied, that the use thereof will not infringe any patent. The data set forth in all tables, charts, graphs and figures herein are based on samples tested and are not guaranteed for all samples or applications. Such data are intended as guides and do not reflect product specifications for any particular product. NO REPRESENTATION OR WARRANTIES, EITHER EXPRESSED OR IMPLIED, OR MERCHANTABILITY, FITNESS FOR A PARTICULAR PURPOSE OR OF ANY OTHER NATURE ARE MADE HEREUNDER WITH RESPECT TO INFORMATION OR THE PRODUCT TO WHICH INFORMATION REFERS.

EZ Peel™ is a trademark of Laird Technologies.



1.800.843.4556 | [www.lairdtech.com](http://www.lairdtech.com) | NORTH AMERICA | EUROPE | ASIA

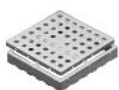

Board Level Shields



Fingerstock



Fabric-Over-Foam



Form-In-Place



Conductive Elastomers



Microwave Absorbers



Wire Mesh

[www.DataSheet4U.com](http://www.DataSheet4U.com)