

BMP085

Digital pressure sensor

Data sheet

Bosch Sensortec



BOSCH

Invented for life



BMP085 Data sheet

Order code 0 273 300 144

Package type LCC8

Data sheet revision 1.2

Release date 15 Oct 2009

Document number BST-BMP085-DS000-05

Notes The BMP085 digital pressure sensor is functionally compatible to the existing Bosch Sensortec SMD500 digital pressure sensor. Product photos and pictures are for illustration purposes only and may differ from the real product's appearance. Specifications are subject to change without notice.

BMP085 Digital pressure sensor

Key features

Pressure range: 300 ... 1100hPa (+9000m ... -500m above sea level)
 Supply voltage: 1.8 ... 3.6V (V_{DDA})
 1.62V ... 3.6V (V_{DDD})

LCC8 package: Robust, ceramic lead-less chip carrier (LCC) package
 Small footprint: 5.0mm x 5.0mm
 Super-flat: 1.2mm height

Low power: 5 μ A at 1 sample / sec. in standard mode

Low noise: 0.06hPa (0.5m) in ultra low power mode
 0.03hPa (0.25m) ultra high resolution mode
 down to 0.1m (rms noise) possible

- Temperature measurement included
- I²C interface
- Fully calibrated
- Pb-free, halogen-free and RoHS compliant,
- MSL 1

New features comparison

	BMP085	SMD500
Smaller package height	1.2mm	1.55mm
Faster conversion time (standard mode each)	7.5ms (max.)	34ms
Faster I ² C data transfer	max. 3.4MHz	max. 400kHz
Extended min. supply voltage	min. 1.8V	min. 2.2V
Lower stand-by current (typ.)	0.1 μ A	0.7 μ A
External clock	not necessary	necessary

Typical applications

- Enhancement of GPS navigation (dead-reckoning, slope detection, etc.)
- In- and out-door navigation
- Leisure and sports
- Weather forecast
- Vertical velocity indication (rise/sink speed)

 BOSCH	BMP085 Data sheet	Bosch Sensortec
--	-----------------------------	-----------------

BMP085 general description

The BMP085 is the fully pin- and function compatible successor of the SMD500, a new generation of high precision digital pressure sensors for consumer applications. The universal C-code SMD500/BMP085 ("BMP085_SMD500_API") is fully upward compatible to SMD500 and recognizes automatically the device ID. Customers already working with the SMD500 pressure sensor are invited to contact Bosch Sensortec as soon as they intend to switch-over to the BMP085 sensor for getting first-hand support.

The ultra-low power, low voltage electronics of the BMP085 is optimized for use in mobile phones, PDAs, GPS navigation devices and outdoor equipment. With a low altitude noise of merely 0.25m at fast conversion time, the BMP085 offers superior performance. The I²C interface allows for easy system integration with a microcontroller.

The BMP085 is based on piezo-resistive technology for EMC robustness, high accuracy and linearity as well as long term stability.

Robert Bosch is the world market leader for pressure sensors in automotive applications. Based on the experience of over 200 million pressure sensors in the field, the BMP085 continues a new generation of micro-machined pressure sensors.

TABLE OF CONTENTS

1 ELECTRICAL CHARACTERISTICS	6
2 ABSOLUTE MAXIMUM RATINGS	7
3 OPERATION	8
3.1 GENERAL DESCRIPTION	8
3.2 GENERAL FUNCTION AND APPLICATION SCHEMATICS	8
3.3 MEASUREMENT OF PRESSURE AND TEMPERATURE.....	10
3.4 CALIBRATION COEFFICIENTS	12
3.5 CALCULATING PRESSURE AND TEMPERATURE.....	12
3.6 CALCULATING ABSOLUTE ALTITUDE	14
3.7 CALCULATING PRESSURE AT SEA LEVEL.....	14
4 I²C INTERFACE	15
4.1 I ² C SPECIFICATION	15
4.2 DEVICE AND REGISTER ADDRESS	16
4.3 I ² C PROTOCOL	16
4.4 START TEMPERATURE AND PRESSURE MEASUREMENT	17
4.5 READ A/D CONVERSION RESULT OR E ² PROM DATA.....	18
5 PACKAGE	19
5.1 PIN CONFIGURATION.....	19
5.2 OUTLINE DIMENSIONS.....	20
5.2.1 <i>Top view (pads not visible)</i>	20
5.2.2 <i>Top view with lid</i>	20
5.2.3 <i>Side view with lid</i>	21
5.3 DEVICE MARKING	22
5.4 TAPE ON REEL	22
5.5 PRINTED CIRCUIT BOARD (PCB) DESIGN.....	23
5.6 MOISTURE SENSITIVITY LEVEL AND SOLDERING	23
5.7 ROHS COMPLIANCY	24
5.8 MOUNTING AND ASSEMBLY RECOMMENDATIONS	25

 BOSCH	BMP085 Data sheet	Bosch Sensortec
--	-----------------------------	-----------------

6 LEGAL DISCLAIMER 26

6.1 ENGINEERING SAMPLES..... 26

6.2 PRODUCT USE 26

6.3 APPLICATION EXAMPLES AND HINTS..... 26

7 DOCUMENT HISTORY AND MODIFICATIONS..... 27

1 Electrical characteristics

If not stated otherwise, the given values are maximum values over temperature/voltage range in the given operation mode.

Parameter	Symbol	Condition	Min	Typ	Max	Units
Operating temperature	T_A	operational	-40		+85	°C
		full accuracy	0		+65	
Supply voltage	V_{DD}	ripple max. 50mVpp	1.8	2.5	3.6	V
	V_{DDIO}		1.62	2.5	3.6	V
Supply current @ 1 sample / sec. 25°C	I_{DDLOW}	ultra low power mode		3		µA
	I_{DDSTD}	standard mode		5		µA
	I_{DDHR}	high resolution mode		7		µA
	I_{DDUHR}	ultra high res. mode		12		µA
Peak current	I_{peak}	during conversion		650	1000	µA
Standby current	I_{DDSBM}	at 25°C		0.1		µA
Serial data clock	f_{SCL}				3.4	MHz
Conversion time temperature	t_{C_temp}	standard mode		3	4.5	ms
Conversion time pressure	$t_{c_p_low}$	ultra low power mode		3	4.5	ms
	$t_{c_p_std}$	standard mode		5	7.5	ms
	$t_{c_p_hr}$	high resolution mode		9	13.5	ms
	$t_{c_p_luhr}$	ultra high res. mode		17	25.5	ms
Absolute accuracy pressure $V_{DD} = 3.3V$		700 ... 1100 hPa 0 ... +65 °C	-2.5	±1.0	+2.5	hPa
		300 ... 700 hPa 0 ... +65 °C	-3.0	±1.0	+3.0	hPa
		300 ... 1100 hPa -20 ... 0 °C	-4.0	±1.5	+4.0	hPa
Resolution of output data		pressure		0.01		hPa
		temperature		0.1		°C
Relative accuracy pressure $V_{DD} = 3.3V$		700 ... 1100 hPa @ 25 °C		±0.2		hPa
		0 ... 65 °C @ p const.		±0.5		hPa
Noise in pressure		see table on page 10				
Absolute accuracy temperature $V_{DD} = 3.3V$		@ 25 °C	-1.5	±0.5	+1.5	°C
		0 ... +65 °C	-2.0	±1.0	+2.0	°C

 BOSCH	BMP085 Data sheet	Bosch Sensortec
--	-----------------------------	-----------------

Solder drifts		Minimum solder height 50µm		±1.0		hPa
Long term stability		12 months		±1.0		hPa

2 Absolute maximum ratings

Parameter	Condition	Min	Max	Units
Storage temperature		-40	+85	°C
Supply voltage	all pins	-0.3	+4.25	V
ESD rating	HBM, R = 1.5kΩ, C = 100pF		±2	kV
Overpressure			10,000	hPa

The BMP085 has to be handled as Electrostatic Sensitive Device (ESD).



3 Operation

3.1 General description

The BMP085 is designed to be connected directly to a microcontroller of a mobile device via the I²C bus. The pressure and temperature data has to be compensated by the calibration data of the E²PROM of the BMP085.

3.2 General function and application schematics

The BMP085 consists of a piezo-resistive sensor, an analog to digital converter and a control unit with E²PROM and a serial I²C interface. The BMP085 delivers the uncompensated value of pressure and temperature. The E²PROM has stored 176 bit of individual calibration data. This is used to compensate offset, temperature dependence and other parameters of the sensor.

- UP = pressure data (16 to 19 bit)
- UT = temperature data (16 bit)

Typical application circuit:

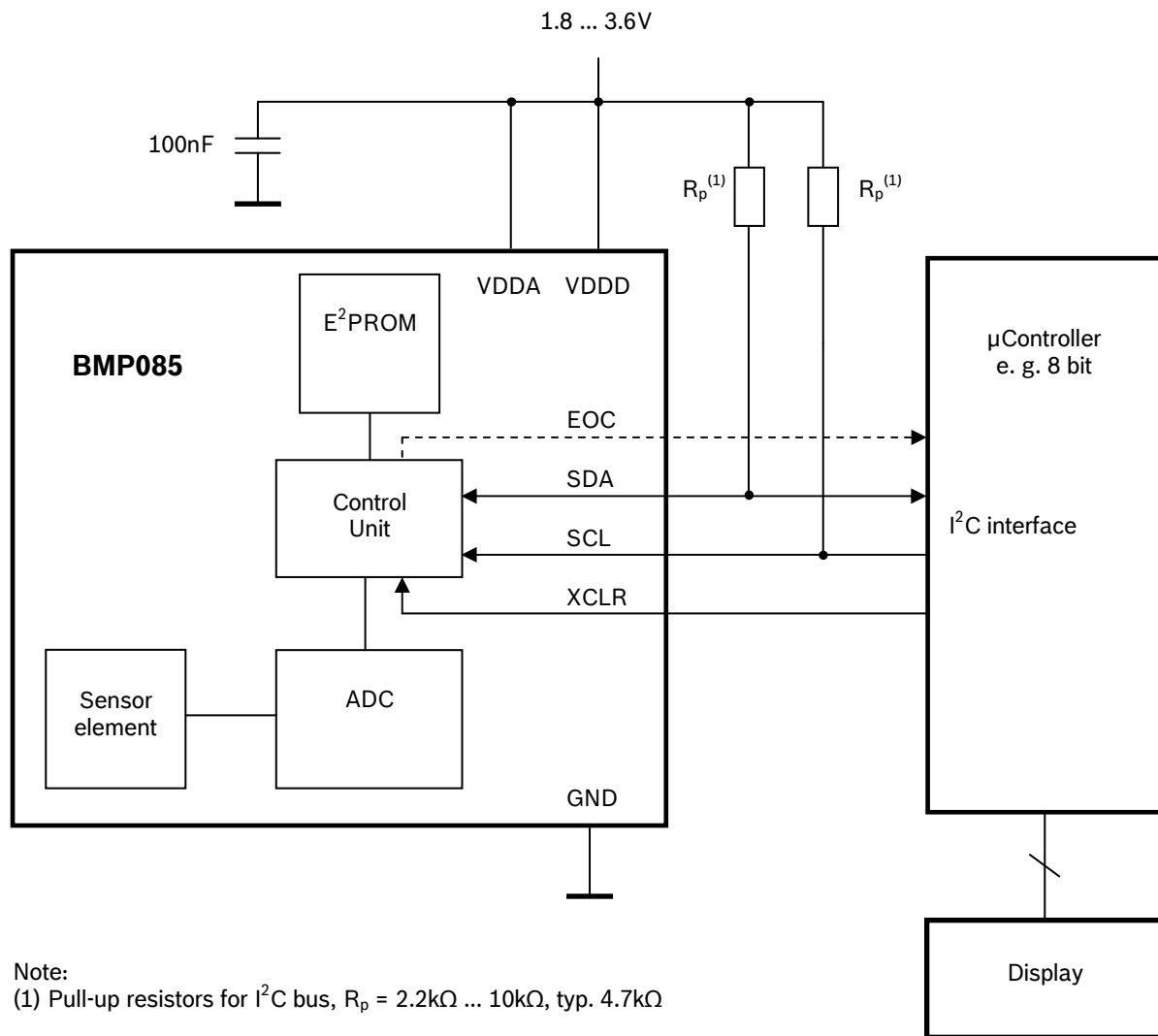

Note:
 (1) Pull-up resistors for I²C bus, R_p = 2.2kΩ ... 10kΩ, typ. 4.7kΩ

Note:
 The BMP085 can be supplied independently with different levels of V_{DDA} and V_{DDD}, which is not possible with the SMD500. In case of different voltage levels, V_{DDA} and V_{DDD} shall have a 100nF decoupling capacitor each.

3.3 Measurement of pressure and temperature

For all calculations presented here an ANSI C code is available from Bosch Sensortec ("BMP085_SMD500_API").

The microcontroller sends a start sequence to start a pressure or temperature measurement. After converting time, the result value (UP or UT, respectively) can be read via the I²C interface. For calculating temperature in °C and pressure in hPa, the calibration data has to be used. These constants can be read out from the BMP085 E²PROM via the I²C interface at software initialization.

The sampling rate can be increased up to 128 samples per second (standard mode) for dynamic measurement. In this case, it is sufficient to measure the temperature only once per second and to use this value for all pressure measurements during the same period.

By using different modes the optimum compromise between power consumption, speed and resolution can be selected, see below table.

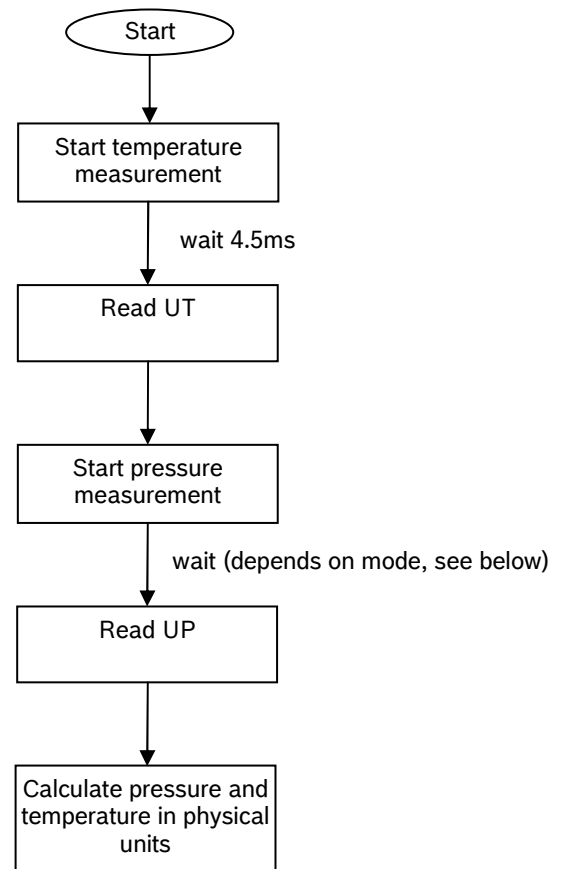

Overview of BMP085 modes, selected by driver software via the variable *oversampling_setting*:

Mode	Parameter <i>oversampling_setting</i>	Internal number of samples	Conversion time pressure max. [ms]	Avg. current @ 1 sample/s typ. [µA]	RMS noise typ. [hPa]	RMS noise typ. [m]
ultra low power	0	1	4.5	3	0.06	0.5
standard	1	2	7.5	5	0.05	0.4
high resolution	2	4	13.5	7	0.04	0.3
ultra high resolution	3	8	25.5	12	0.03	0.25

The noise data is calculated as standard deviation of 10 data points. For further information on noise characteristics see the relevant application note "Noise in pressure sensor applications".

 BOSCH	BMP085 Data sheet	Bosch Sensortec
--	-----------------------------	-----------------

All modes can be performed at higher speeds, e.g. up to 128 times per second for standard mode, with the current consumption increasing proportionally to the sample rate. This way the noise can be decreased further by software averaging.

3.4 Calibration coefficients

The 176 bit E²PROM is partitioned in 11 words of 16 bit each. These contain 11 calibration coefficients. Every sensor module has individual coefficients. Before the first calculation of temperature and pressure, the master reads out the E²PROM data. The data communication can be checked by checking that none of the words has the value 0 or 0xFFFF.

Parameter	BMP085 reg adr	
	MSB	LSB
AC1	0xAA	0xAB
AC2	0xAC	0xAD
AC3	0xAE	0xAF
AC4	0xB0	0xB1
AC5	0xB2	0xB3
AC6	0xB4	0xB5
B1	0xB6	0xB7
B2	0xB8	0xB9
MB	0xBA	0xBB
MC	0xBC	0xBD
MD	0xBE	0xBF

3.5 Calculating pressure and temperature

The mode (ultra low power, standard, high, ultra high resolution) can be selected by the variable *oversampling_setting* (0, 1, 2, 3) in the C code.

The universal code SMD500/BMP085 is fully upward compatible to SMD500 and recognizes automatically the device ID. Thus, the SMD500 can be replaced "on the fly" by the BMP085 without changing hardware or software.

Calculation of true temperature and pressure in steps of 1Pa (= 0.01hPa = 0.01mbar) and temperature in steps of 0.1°C.

The following figure shows the detailed algorithm for pressure and temperature measurement.

This algorithm is available to customers as reference C source code ("BMP085_SMD500_API") from Bosch Sensortec and via its sales and distribution partners. **Please contact your Bosch Sensortec representative for details.**

Calculation of pressure and temperature for BMP085

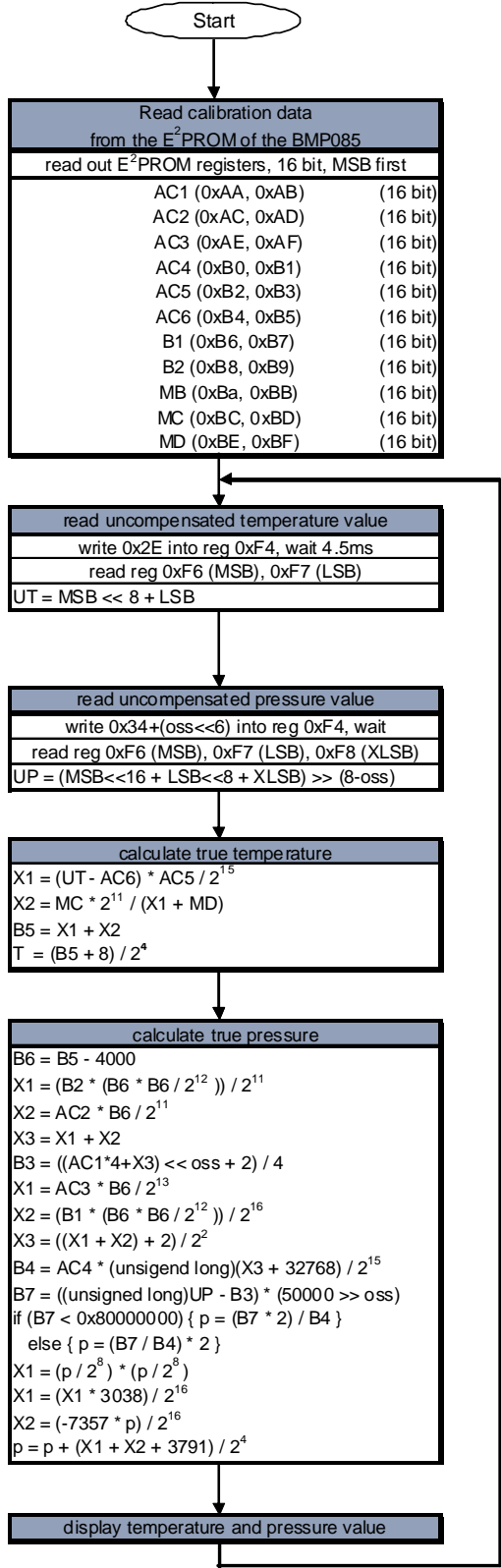

example:		C code function: type:
		<code>bmp085_get_cal_param</code>
AC1 =	408	short
AC2 =	-72	short
AC3 =	-14383	short
AC4 =	32741	unsigned short
AC5 =	32757	unsigned short
AC6 =	23153	unsigned short
B1 =	6190	short
B2 =	4	short
MB =	-32768	short
MC =	-8711	short
MD =	2868	short
		<code>bmp085_get_ut</code>
UT =	27898	long
oss =	0	
= oversampling_setting (ultra low power mode)		
		<code>bmp085_get_up</code>
UP =	23843	long
		<code>bmp085_get_temperature</code>
X1 =	4743	long
X2 =	-2344	long
B5 =	2399	long
T =	150	temp in 0.1°C long
		<code>BMP085_calpressure</code>
B6 =	-1601	long
X1 =	1	long
X2 =	56	long
X3 =	57	long
B3 =	422	long
X1 =	2810	long
X2 =	59	long
X3 =	717	long
B4 =	33457	unsigned long
B7 =	1171050000	unsigned long
p =	70003	long
		long
X1 =	74529	long
X1 =	3454	long
X2 =	-7859	long
p =	69964	press. in Pa long

3.6 Calculating absolute altitude

With the measured pressure p and the pressure at sea level p_0 e.g. 1013.25hPa, the altitude in meters can be calculated with the international barometric formula:

$$\text{altitude} = 44330 * \left(1 - \left(\frac{p}{p_0} \right)^{\frac{1}{5.255}} \right)$$

Thus, a pressure change of $\Delta p = 1\text{hPa}$ corresponds to 8.43m at sea level

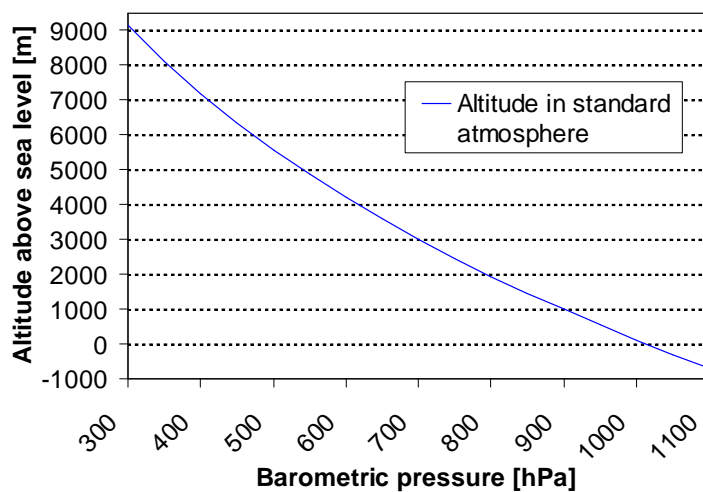

3.7 Calculating pressure at sea level

With the measured pressure p and the absolute altitude the pressure at sea level can be calculated:

$$p_0 = \frac{p}{\left(1 - \frac{\text{altitude}}{44330} \right)^{5.255}}$$

Thus, a difference in altitude of $\Delta \text{altitude} = 10\text{m}$ corresponds to 1.2hPa pressure change at sea level.

4 I²C Interface

- I²C is a digital two wire interface
- Clock frequencies up to 3.4Mbit/sec. (I²C standard, fast and high-speed mode supported)
- SCL and SDA needs a pull-up resistor, typ. 4.7kOhm to V_{DD}
(one resistor each for all the I²C bus)

The I²C bus is used to control the sensor, to read calibration data from the E²PROM and to read the measurement data when A/D conversion is finished. SDA (serial data) and SCL (serial clock) have open-drain outputs.

For detailed I²C-bus specification please refer to:
http://www.nxp.com/acrobat_download/literature/9398/39340011.pdf

The BMP085 has a master clear (XCLR) low-active input that is used to reset the BMP085 and initializes internal registers and counters. The device is automatically reset by power on reset (POR) circuitry. XCLR can be left floating if not used. The pad has an internal pull-up resistor of typ. 120kOhm.

4.1 I²C specification

Electrical parameters for the I²C interface:

Parameter	Symbol	Min.	Typ	Max.	Units
Clock input frequency	f _{SCL}			3.4	MHz
Input-low level	V _{IL}	0		0.2 * V _{DD}	V
Input-high level	V _{IH}	0.8 * V _{DD}		V _{DD}	V
SDA and SCL pull-up resistor	R _{pull-up}	2.2		10	kOhm
SDA sink current @ V _{DD} = 1.62V, V _{OL} = 0.3V	I _{SDA_sink}		9		mA
EOC sink current @ V _{DD} = 1.62V, V _{OL} = 0.3V	I _{SDA_sink}		7.7		mA
EOC source current @ V _{DD} = 1.62V, V _{OH} = 1.32V	I _{SDA_source}		1.5		mA
XCLR pulse length	t _{XCLR}	1			µs
Start-up time after power-up, before first communication	t _{Start}	10			ms

4.2 Device and register address

The BMP085 module address is shown below. The LSB of the device address distinguishes between read (1) and write (0) operation, corresponding to address 0xEF (read) and 0xEE (write).

A7	A6	A5	A4	A3	A2	A1	W/R
1	1	1	0	1	1	1	0/1

There is an easy way to connect two BMP085 to the same I²C bus: You can use the XCLR input of BMP085 to set one BMP085 part silent while you communicate with the other BMP085 part via I²C and vice versa. The signals can be provided by two digital outputs of the microcontroller, or one digital output and one inverter.

4.3 I²C protocol

The I²C interface protocol has special bus signal conditions. Start (S), stop (P) and binary data conditions are shown below. At start condition, SCL is high and SDA has a falling edge. Then the slave address is sent. After the 7 address bits, the direction control bit R/W selects the read or write operation. When a slave device recognizes that it is being addressed, it should acknowledge by pulling SDA low in the ninth SCL (ACK) cycle.

At stop condition, SCL is also high, but SDA has a rising edge. Data must be held stable at SDA when SCL is high. Data can change value at SDA only when SCL is low.

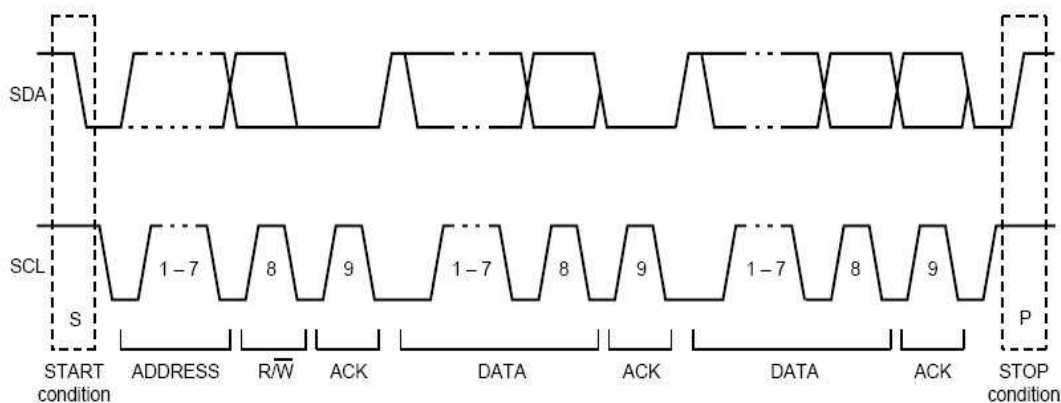

4.4 Start temperature and pressure measurement

The timing diagrams to start the measurement of the temperature value UT and pressure value UP are shown below. After start condition the master sends the device address write, the register address and the control register data. The BMP085 sends an acknowledgement (ACKS) every 8 data bits when data is received. The master sends a stop condition after the last ACKS.

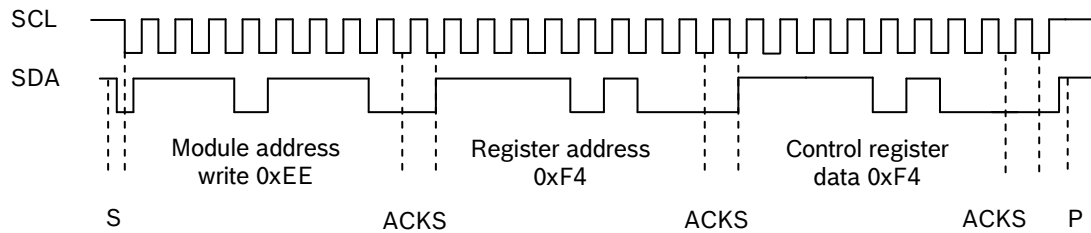

Timing diagram for starting pressure measurement

Abbreviations:

- S Start
- P Stop
- ACKS Acknowledge by Slave
- ACKM Acknowledge by Master
- NACKM Not Acknowledge by Master

Control registers values for different internal *oversampling_setting* (osrs):

Measurement	Control register value (register address 0xF4)	Max. conversion time [ms]
Temperature	0x2E	4.5
Pressure (osrs = 0)	0x34	4.5
Pressure (osrs = 1)	0x74	7.5
Pressure (osrs = 2)	0xB4	13.5
Pressure (osrs = 3)	0xF4	25.5

Instead of waiting for the maximum conversion time, the output pin EOC (end of conversion) can be used to check if the conversion is finished (logic 1) or still running (logic 0). After the conversion is finished BMP085 switches automatically in standby mode.

4.5 Read A/D conversion result or E²PROM data

To read out the temperature data word UT (16 bit), the pressure data word UP (16 to 19 bit) and the E²PROM data proceed as follows:

After the start condition the master sends the module address write command and register address. The register address selects the read register:

E ² PROM data registers	0xAA to 0xBF
Temperature or pressure value UT or UP	0xF6 (MSB), 0xF7 (LSB), optionally 0xF8 (XLSB)

Then the master sends a restart condition followed by the module address read that will be acknowledged by the BMP085 (ACKS). The BMP085 sends first the 8 MSB, acknowledged by the master (ACKM), then the 8 LSB. The master sends a "not acknowledge" (NACKM) and finally a stop condition.

Optionally for ultra high resolution, the XLSB register with address 0xF8 can be read to extend the 16 bit word to up to 19 bits; refer to the application programming interface (API) software rev. 1.1 ("BMP085_SMD500_API", available from Bosch Sensortec).

Timing diagram read 16 bit A/D conversion result:

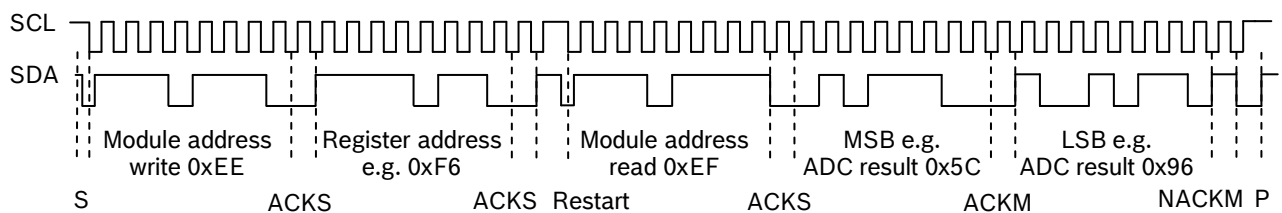

5 Package

5.1 Pin configuration

Picture shows the device in top view. Device pins are shown here transparently only for orientation purposes.

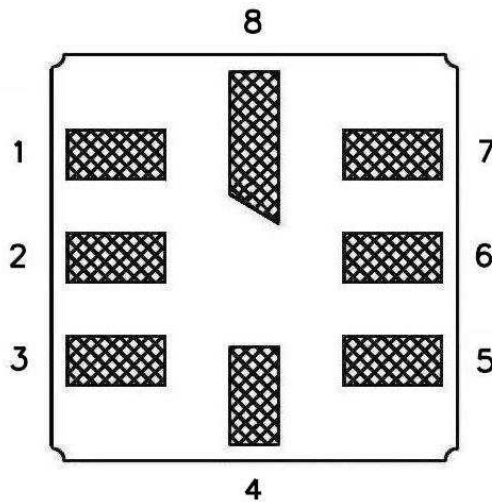

Pin No.	Name	Function	Type
1	GND	Ground	Power
2	EOC	End of conversion	Digital output
3	V _{DDA}	Power supply	Power
4	V _{DDD}	Digital power supply	Power
5	NC	no internal connection	-
6	SCL	I ² C serial bus clock input	Digital input
7	SDA	I ² C serial bus data	Digital bi-directional
8	XCLR	master clear (low active) input	Digital input

5.2 Outline dimensions

The sensor housing is a standard 8-pin lead-less chip carrier (LCC8) ceramic package. Its dimensions are 5.0mm x 5.0mm ($\pm 0.25\text{mm}$) x 1.2mm ($\pm 0.12\text{mm}$).

Package weight is approximately 0.09grams.

Note: All dimensions are in mm.

5.2.1 Top view

Device pins are shown here transparently only for orientation purposes.

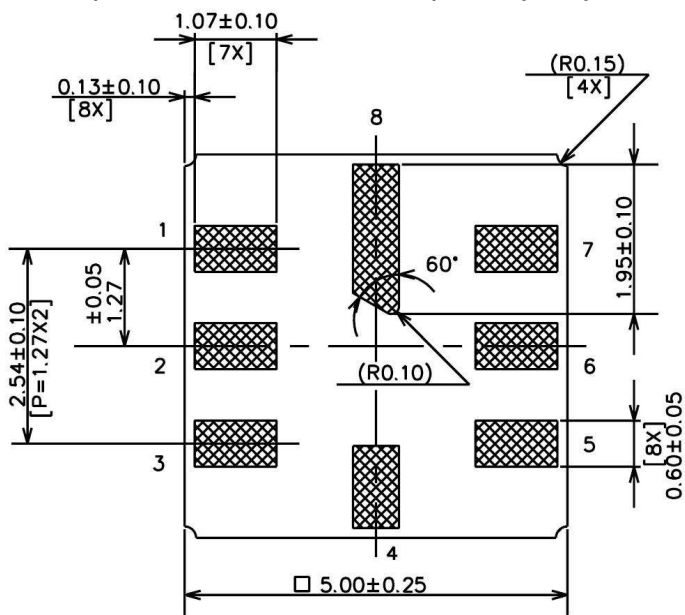

5.2.2 Top view with lid

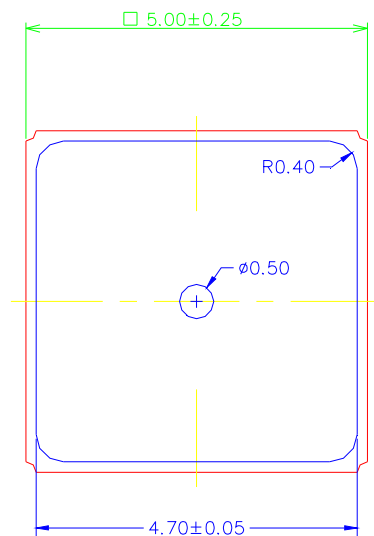

5.2.3 Side view with lid

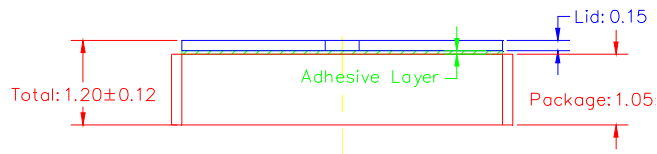

5.3 Device marking

The device lid shows the following laser-marking:

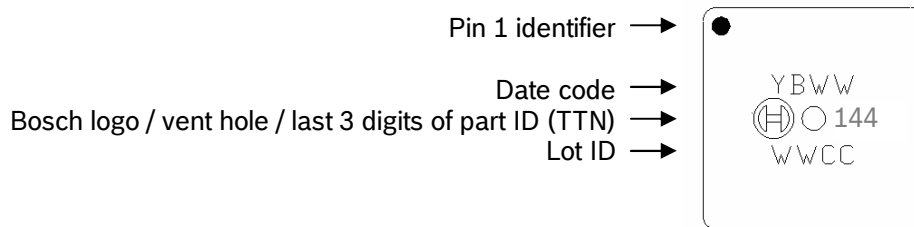

The vent hole (diameter 0.5mm) is in the center of the lid, between the Bosch logo and the part ID code (144).

5.4 Tape on reel

Number of parts per reel: 3,000

Orientation of the parts inside the reel is according to EN60286-3.

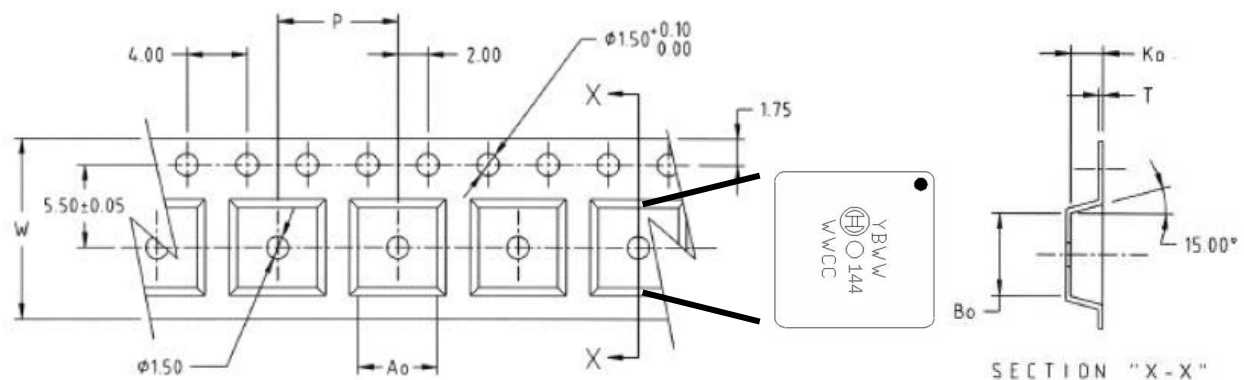

Carrier tape material: Conductive polystyrene C 100, $10^3 - 10^6$ Ohm/sq.

Dimensions are in mm:

$$A_0 = 5.30 \pm 0.10$$

$$B_0 = 5.30 \pm 0.10$$

$$K_0 = 2.10 \pm 0.10$$

$$P = 8.00 \pm 0.10$$

$$W = 12.00 +0.30 / -0.10$$

$$t = 0.30 \pm 0.05$$

The bars between the cavities are embossed about 0.2mm into the direction of K_0 . All other dimensions and tolerances follow the EIA 481 standard.

5.5 Printed circuit board (PCB) design

Recommended PCB design (top view):

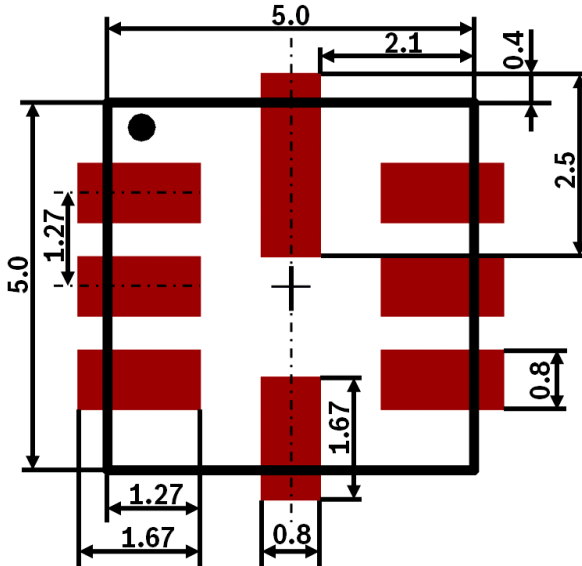

5.6 Moisture sensitivity level and soldering

The BMP085 is classified MSL 1 (moisture sensitivity level) according to IPC/JEDEC standards J-STD-020D and J-STD-033A.

The device can be soldered Pb-free with a peak temperature of 260°C for 20 to 40 sec. The minimum height of the solder after reflow shall be at least 50µm. This is required for good mechanical decoupling between the sensor device and the printed circuit board (PCB).

The BMP085 devices have to be soldered within 6 months after shipment (shelf life). To ensure good solder-ability, the devices shall be stored at room temperature (20°C).

The soldering process can lead to an offset shift of typically 1hPa.

 BOSCH	BMP085 Data sheet	Bosch Sensortec
--	-----------------------------	-----------------

5.7 RoHS compliancy

The BMP085 sensor meets the requirements of the EC directive "Restriction of hazardous substances (RoHS)", please refer also to:

"Directive 2002/95/EC of the European Parliament and of the Council of 27 January 2003 on the restriction of the use of certain hazardous substances in electrical and electronic equipment".

The BMP085 sensor is also halogen-free. Please contact your Bosch Sensortec representative for the corresponding analysis report.

 BOSCH	BMP085 Data sheet	Bosch Sensortec
--	-----------------------------	-----------------

5.8 Mounting and assembly recommendations

Please read the following recommendations carefully:

- The clearance above the metal lid shall be 0.1mm at minimum.
- For the device housing appropriate venting needs to be provided in case the ambient pressure shall be measured. If waterproof packaging is needed, venting can be accomplished by a vent element with a membrane like Gore-Tex^(TM).
- Liquids shall not come into direct contact with the device.
- During operation the sensor is sensitive to light, which can influence the accuracy of the measurement (photo-current of silicon). Therefore, the hole in the top lid shall not be exposed to direct light during operation.
- The BMP085 shall not be placed close to fast heating parts. In case of gradients > 3°C/sec. it is recommended to follow Bosch Sensortec application note ANP015, "Correction of errors induced by fast temperature changes". Please contact your Bosch Sensortec representative for details.
- For further details, please refer to the BMP085 handling, soldering & mounting instructions manual that is also available from Bosch Sensortec.

 BOSCH	BMP085 Data sheet	Bosch Sensortec
--	-----------------------------	-----------------

6 Legal disclaimer

6.1 Engineering samples

Engineering Samples are marked with an asterisk (*) or (e). Samples may vary from the valid technical specifications of the product series contained in this data sheet. They are therefore not intended or fit for resale to third parties or for use in end products. Their sole purpose is internal client testing. The testing of an engineering sample may in no way replace the testing of a product series. Bosch Sensortec assumes no liability for the use of engineering samples. The Purchaser shall indemnify Bosch Sensortec from all claims arising from the use of engineering samples.

6.2 Product use

Bosch Sensortec products are developed for the consumer goods industry. They may only be used within the parameters of this product data sheet. They are not fit for use in life-sustaining or security sensitive systems. Security sensitive systems are those for which a malfunction is expected to lead to bodily harm or significant property damage. In addition, they are not fit for use in products which interact with motor vehicle systems.

The resale and/or use of products are at the purchaser's own risk and his own responsibility. The examination of fitness for the intended use is the sole responsibility of the Purchaser.

The purchaser shall indemnify Bosch Sensortec from all third party claims arising from any product use not covered by the parameters of this product data sheet or not approved by Bosch Sensortec and reimburse Bosch Sensortec for all costs in connection with such claims.

The purchaser must monitor the market for the purchased products, particularly with regard to product safety, and inform Bosch Sensortec without delay of all security relevant incidents.

6.3 Application examples and hints

With respect to any examples or hints given herein, any typical values stated herein and/or any information regarding the application of the device, Bosch Sensortec hereby disclaims any and all warranties and liabilities of any kind, including without limitation warranties of non-infringement of intellectual property rights or copyrights of any third party. The information given in this document shall in no event be regarded as a guarantee of conditions or characteristics. They are provided for illustrative purposes only and no evaluation regarding infringement of intellectual property rights or copyrights or regarding functionality, performance or error has been made.

 BOSCH	BMP085 Data sheet	Bosch Sensortec
--	-----------------------------	-----------------

7 Document history and modifications

Rev. No	Chapter	Description of modifications/changes	Date
0.1		First edition for description of serial production material	
0.2		Noise data update, peak current added, several minor changes	19-Feb-2008
0.3	1	Update peak current, typo correction	21-Apr-2008
	1	Changed V_{DDA} to V_{DD} and V_{DDD} to V_{DDIO}	21-Apr-2008
	3.5	Updated flow diagram	21-Apr-2008
	4	New comment on floating XCLR	21-Apr-2008
	4.1	Added details on start-up time	21-Apr-2008
	5.2	Added package weight	21-Apr-2008
1.0	1	Absolute accuracy at -20°C added	01-July-2008
	2	Updated storage temperature	01-July-2008
	3.2	Added optional EOC to schematic	01-July-2008
	5.7	BMP085 is halogen-free	01-July-2008
1.1	3.3	Added comment on noise data calculation	06-April-2009
	3.5	Variable type of B7 is unsigned long	
	4	Added comment on low active master clear and 120kOhms pull-up resistor	
	4.2	Added solution to connect two devices BMP085 to the same I2C bus.	
	4.4	Added remark about automatic standby-mode	
	5.6	JEDEC J-STD-020D	
	5.5	Updated or recommended PCB-design picture	
	5.8	Explained that light sensitivity is only during operation	
1.2	3.5	Added comment on availability of the ref. source code	15-Oct-2009

Bosch Sensortec GmbH
Gerhard-Kindler-Strasse 8
72770 Reutlingen / Germany

contact@bosch-sensortec.com
www.bosch-sensortec.com

Modifications reserved | Printed in Germany
Specifications are subject to change without notice
Version_1.2_102009
Document number: BST-BMP085-DS000-05