

Non-Isolated Step-Down 3-Terminal DC/DC Converters

BP5277-33 / BP5277-50 / BP5277-90 / BP5277-12 / BP5277-13 / BP5277-15

● Description

The BP5275 series of DC/DC converters utilize high rated voltage. A control circuit, switching element, and coil are built in, along with input/output capacitors, resulting in stable operation with no external components required. High conversion efficiency, combined with an original heat dissipation structure, enables configuration an ultra-compact switching power supplies. 500mA output is possible with no heat sink required (800mA with heat sink). In addition, the ICs are pin-compatible with conventional TO-220 LDO regulators, making replacement easy. Low ripple voltage with high precision output ensure stable operation against the fluctuating voltages from main power supplies, making them ideal for use as local power supplies (i.e. for microcontrollers).

● Applications

Power supplies for copiers, personal computers, facsimiles, AV equipment, measuring instruments, vending machines, security device, registers, industrial equipment, and maintenance tools

● Features

- 1) High rated voltage
- 2) No external parts required
- 3) High power conversion efficiency.
- 4) Heat sink unnecessary.
- 5) Low output ripple voltage
- 6) High output voltage accuracy
- 7) Pin-compatible with conventional 3-pin LDOs
- 8) Compact package.

BP5277-33 / BP5277-50 / BP5277-90 / BP5277-12 / BP5277-13 / BP5277-15 : SIP3

● List of the series

	BP5277-33	BP5277-50	BP5277-90	BP5277-12	BP5277-13	BP5277-15	Unit
Input voltage	36	36	36	36	36	36	V
Output voltage	3.3	5	9	12	13	15	V
Maximum output current (no heat sink / include heat sink)	500 / 800	500 / 800	500 / 800	500 / 800	500 / 800	500 / 800	mA
Power conversion efficiency (Vi=24V)	76	83	88	90	91	93	%

● Absolute maximum ratings (Ta=25°C)

Parameter	Symbol	Limits						Unit
		BP5277-33	BP5277-50	BP5277-90	BP5277-12	BP5277-13	BP5277-15	
Input voltage	Vi	36	36	36	36	36	36	V
Operating temperature range	Topr	-30 to 85	-30 to 85	-30 to 85	-30 to 85	-30 to 85	-30 to 85	°C
Storage temperature range	Tstg	-40 to 105	-40 to 105	-40 to 105	-40 to 105	-40 to 105	-40 to 105	°C
Allowable maximum surface temperature	Tcmax	100	100	100	100	100	100	°C
Maximum output current 1	Io1max	500	500	500	500	500	500	mA
Maximum output current 2 (with Heat Sink)	Io2max	800	800	800	800	800	800	mA

● Dimensions (Unit : mm)

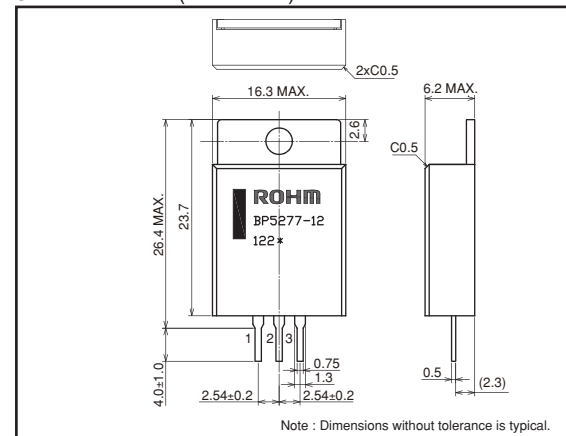

● Pin function

Pin No.	Pin Name	Function
1	Vi	Input terminal
2	GND	GND
3	Vo	Output terminal

● Block diagram

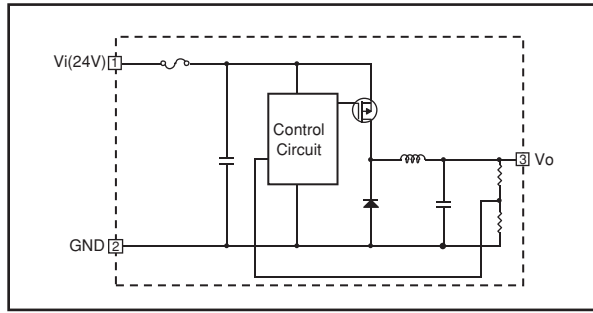

● Measurement circuit

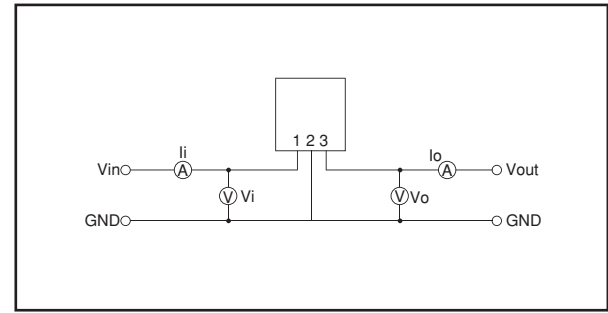

● Electrical characteristics

BP5277-33 (Unless otherwise noted, Vi=24.0V, Io1=500mA)

Parameter	Symbol	Min.	Typ.	Max.	Unit	Conditions
Input voltage	Vi	8.0	24.0	32.0	V	DC
Output voltage	Vo	3.23	3.30	3.37	V	Io1=0mA
Output current 1	Io1	0	-	500	mA	*1
Output current 2	Io2	0	-	800	mA	With heat sink *1
Line regulation	Vr	-	5	50	mV	Vi=8 to 32V
Load regulation	Vl	-	5	50	mV	Io=0 to 500mA
Output ripple voltage	Vp	-	40	100	mV _{P-P}	
Conversion efficiency	η	71	76	-	%	
Operation frequency	f	-	900	-	kHz	

*1 Max output current should be reduced according to the surrounding temperature.

BP5277-50 (Unless otherwise noted, Vi=24.0V, Io1=500mA)

Parameter	Symbol	Min.	Typ.	Max.	Unit	Conditions
Input voltage	Vi	8.0	24.0	32.0	V	DC
Output voltage	Vo	4.90	5.00	5.10	V	Io1=0mA
Output current 1	Io1	0	-	500	mA	*1
Output current 2	Io2	0	-	800	mA	With heat sink *1
Line regulation	Vr	-	5	50	mV	Vi=8 to 32V
Load regulation	Vl	-	5	50	mV	Io=0 to 500mA
Output ripple voltage	Vp	-	40	100	mV _{P-P}	
Conversion efficiency	η	78	83	-	%	
Operation frequency	f	-	900	-	kHz	

*1 Max output current should be reduced according to the surrounding temperature.

BP5277-90 (Unless otherwise noted, Vi=24.0V, Io1=500mA)

Parameter	Symbol	Min.	Typ.	Max.	Unit	Conditions
Input voltage	Vi	12.0	24.0	32.0	V	DC
Output voltage	Vo	8.80	9.00	9.20	V	Io1=0mA
Output current 1	Io1	0	-	500	mA	*1
Output current 2	Io2	0	-	800	mA	With heat sink *1
Line regulation	Vr	-	5	50	mV	Vi=12 to 32V
Load regulation	Vl	-	5	50	mV	Io=0 to 500mA
Output ripple voltage	Vp	-	40	100	mV _{P-P}	
Conversion efficiency	η	83	88	-	%	
Operation frequency	f	-	900	-	kHz	

*1 Max output current should be reduced according to the surrounding temperature.

● Electrical characteristics

BP5277-12 (Unless otherwise noted, $V_i=24.0V$, $I_{o1}=500mA$)

Parameter	Symbol	Min.	Typ.	Max.	Unit	Conditions
Input voltage	V_i	15.0	24.0	32.0	V	DC
Output voltage	V_o	11.75	12.00	12.25	V	$I_{o1}=0mA$
Output current 1	I_{o1}	0	-	500	mA	*1
Output current 2	I_{o2}	0	-	800	mA	With heat sink *1
Line regulation	V_r	-	5	50	mV	$V_i=15$ to 32V
Load regulation	V_l	-	5	50	mV	$I_o=0$ to 500mA
Output ripple voltage	V_p	-	40	100	mV _{P-P}	
Conversion efficiency	η	85	90	-	%	
Operation frequency	f	-	900	-	kHz	

*1 Max output current should be reduced according to the surrounding temperature.

BP5277-13 (Unless otherwise noted, $V_i=24.0V$, $I_{o1}=500mA$)

Parameter	Symbol	Min.	Typ.	Max.	Unit	Conditions
Input voltage	V_i	16.5	24.0	32.0	V	DC
Output voltage	V_o	12.70	13.00	13.30	V	$I_{o1}=0mA$
Output current 1	I_{o1}	0	-	500	mA	*1
Output current 2	I_{o2}	0	-	800	mA	With heat sink *1
Line regulation	V_r	-	5	50	mV	$V_i=16.5$ to 32V
Load regulation	V_l	-	5	50	mV	$I_o=0$ to 500mA
Output ripple voltage	V_p	-	40	100	mV _{P-P}	
Conversion efficiency	η	86	91	-	%	
Operation frequency	f	-	900	-	kHz	

*1 Max output current should be reduced according to the surrounding temperature.

BP5277-15 (Unless otherwise noted, $V_i=24.0V$, $I_{o1}=500mA$)

Parameter	Symbol	Min.	Typ.	Max.	Unit	Conditions
Input voltage	V_i	19.0	24.0	32.0	V	DC
Output voltage	V_o	14.70	15.00	15.30	V	$I_{o1}=0mA$
Output current 1	I_{o1}	0	-	500	mA	*1
Output current 2	I_{o2}	0	-	800	mA	With heat sink *1
Line regulation	V_r	-	5	50	mV	$V_i=19$ to 32V
Load regulation	V_l	-	5	50	mV	$I_o=0$ to 500mA
Output ripple voltage	V_p	-	40	100	mV _{P-P}	
Conversion efficiency	η	88	93	-	%	
Operation frequency	f	-	900	-	kHz	

*1 Max output current should be reduced according to the surrounding temperature.

● OPERATION NOTES

- There is fear of destruction of the internal circuit in case that input voltage exceeds the absolute maximum ratings (36V) by such as a surge occurred because of rapid start-up of power voltage. Be sure not to exceed absolute maximum ratings even momentarily.
- This product has a protection element for safety. The protection element is fused for safety when the current which the protection element will fuse. Please evaluate sufficiently at using environment about the action when the output circuit shorts.
- There are some case that the module generates heat exceeding allowable maximum surface temperature when the load current which exceeds the maximum output current is flowed. Please make design keeping enough margins not to exceed allowable maximum surface temperature at any time under any application or any test conditions.
- The aluminum board at back part of the product is connected to GND.
Please mind the arrangement not to contact surrounding parts.
- When using the module with bent lead pin, it might be destroyed with an extreme stress for the PCB or the aluminum board. Please use the module without bending the lead pin.
- The aluminum board in the back might come off when an excessive stress is put in the direction of the thickness. When fixing to the heat sink etc. to use this product, please mount to PCB after fixing to the heat sink and both the heat sink and this hold to PCB.

● BP5277-33

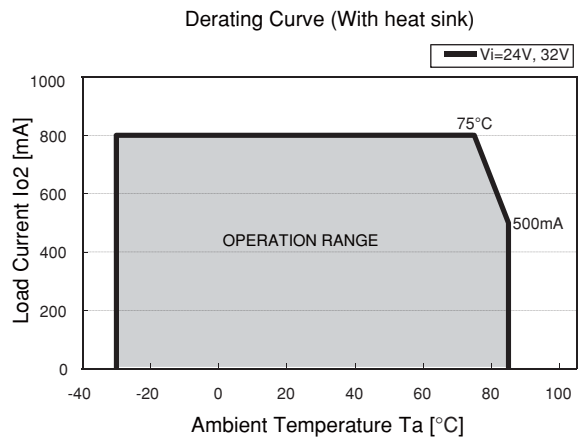
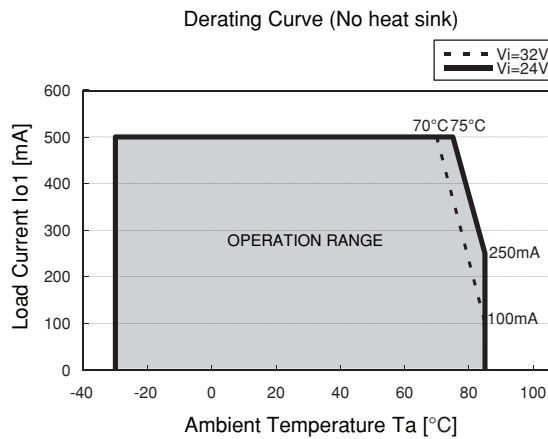
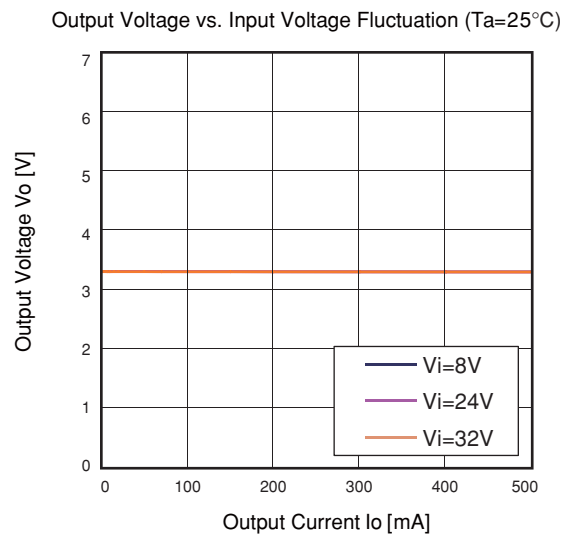
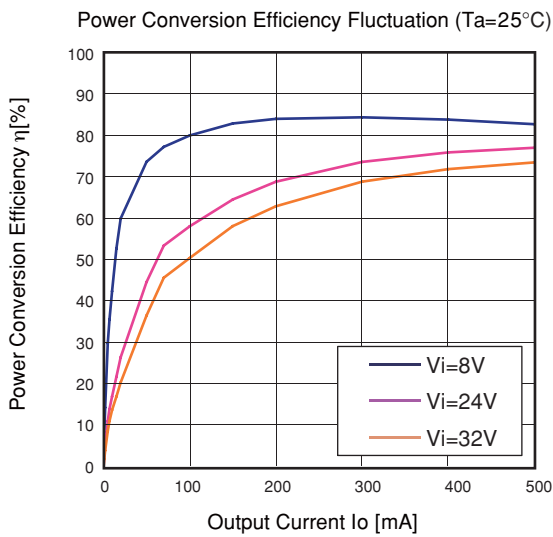
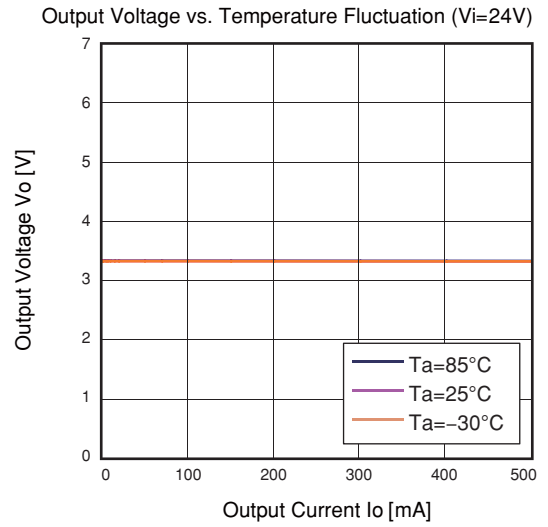
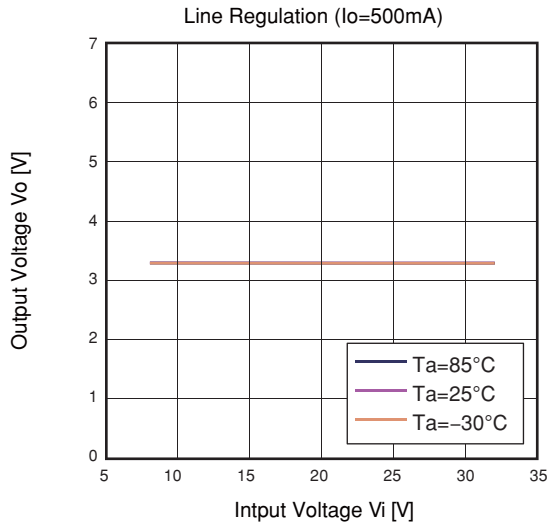

●BP5277-50

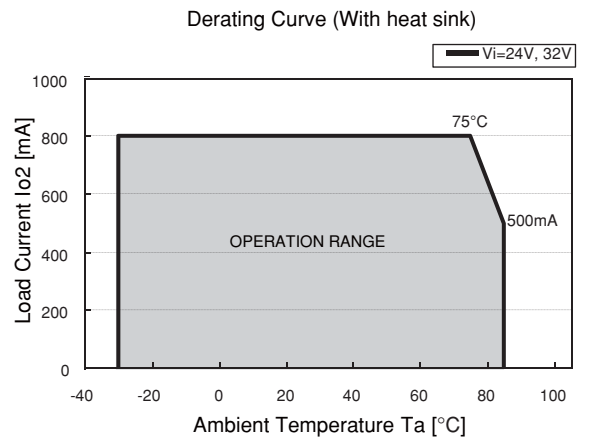
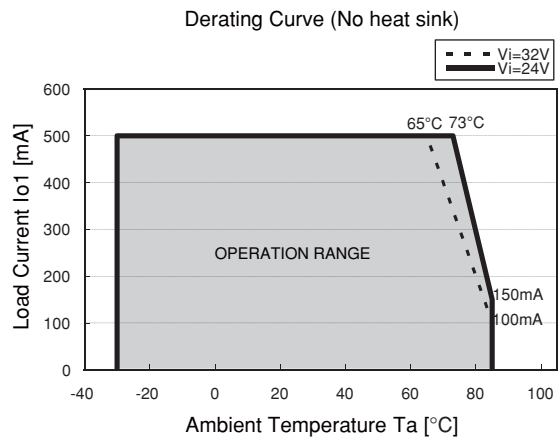
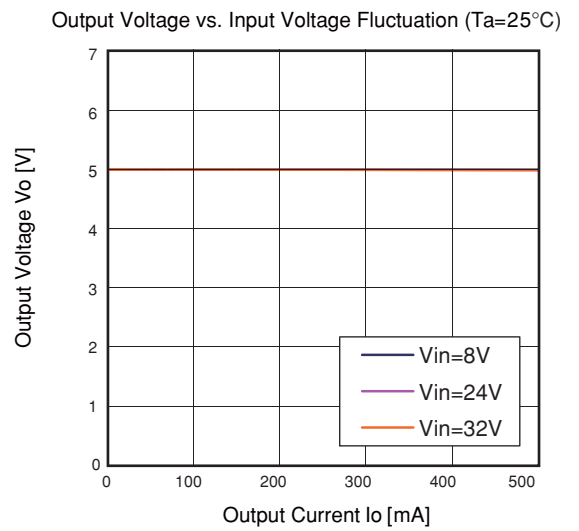
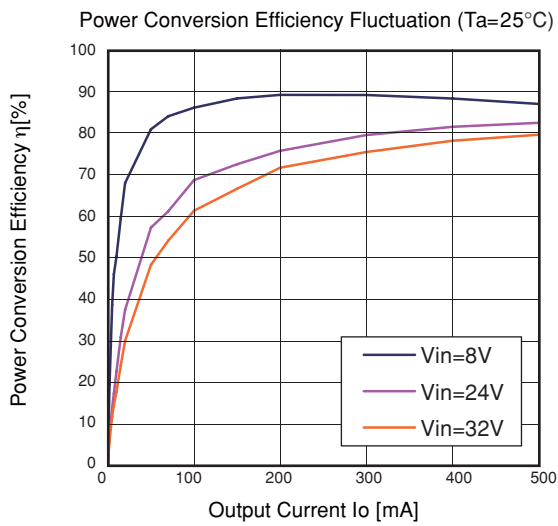
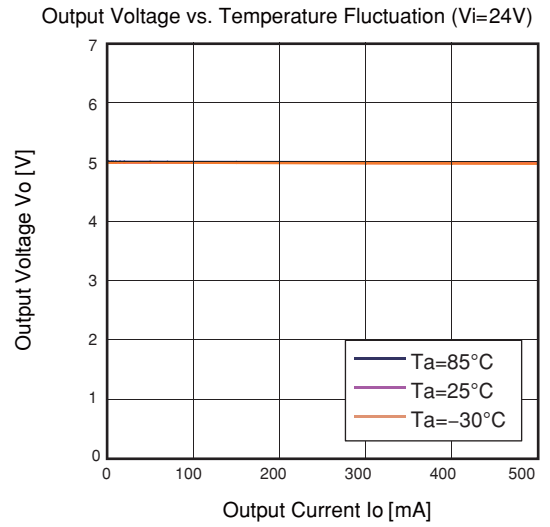
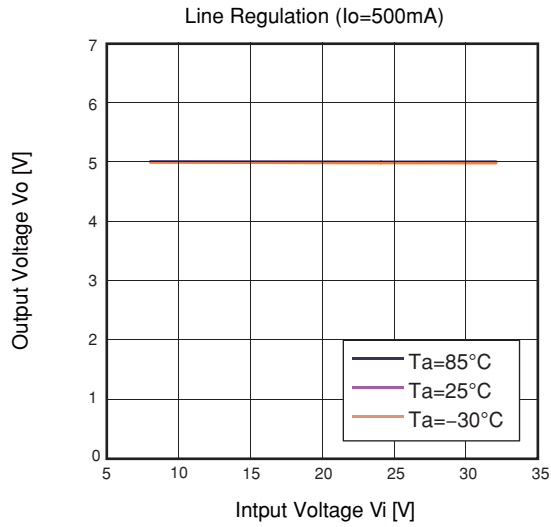

● BP5277-90

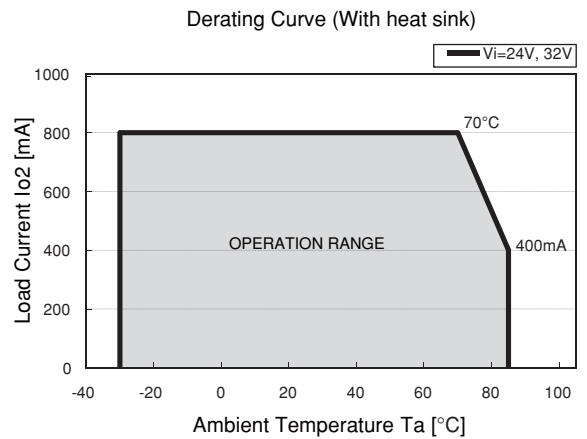
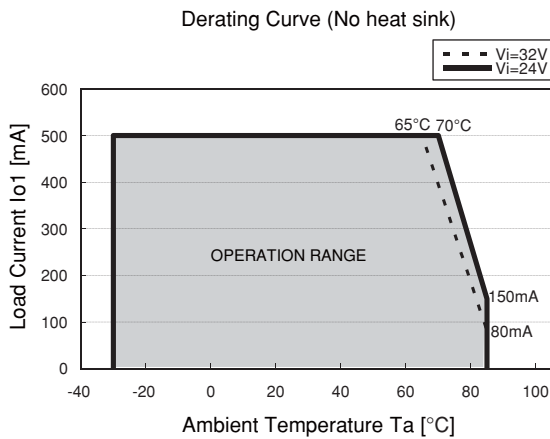
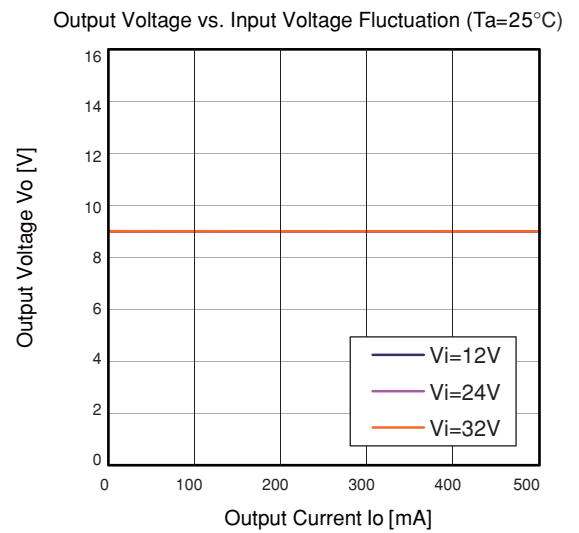
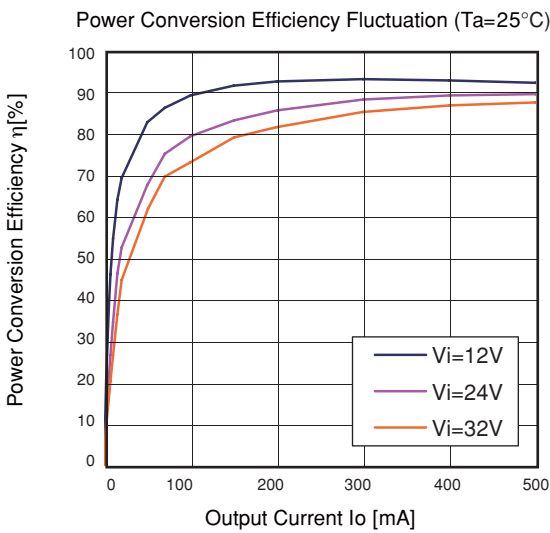
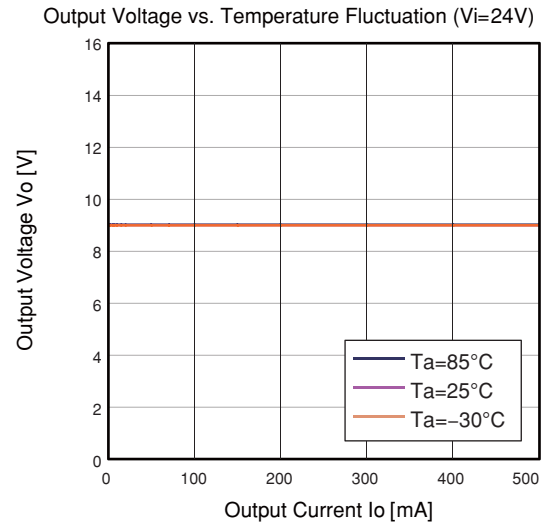
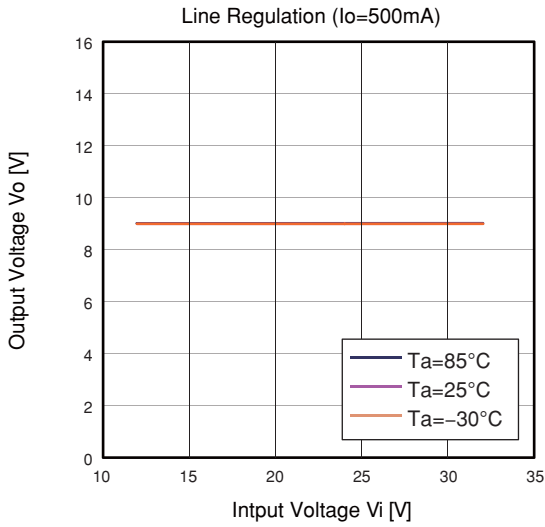

● BP5277-12

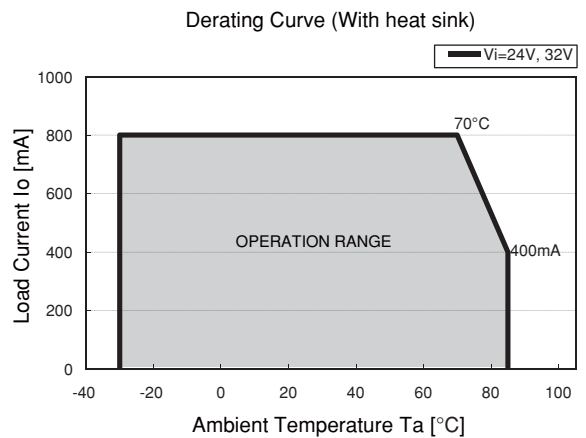
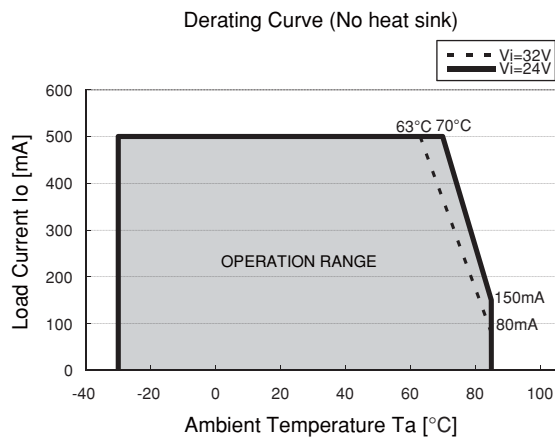
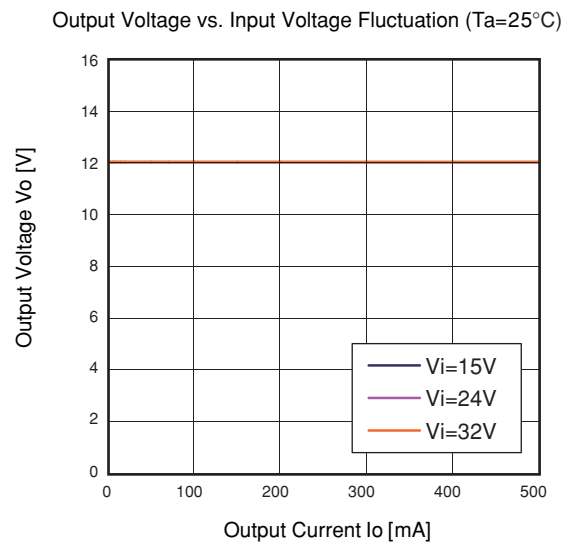
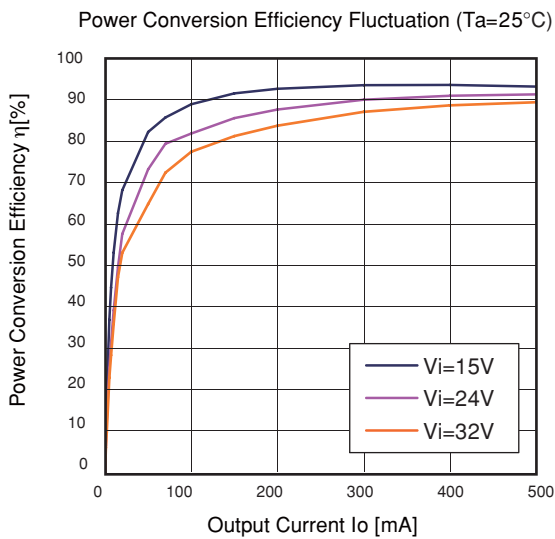
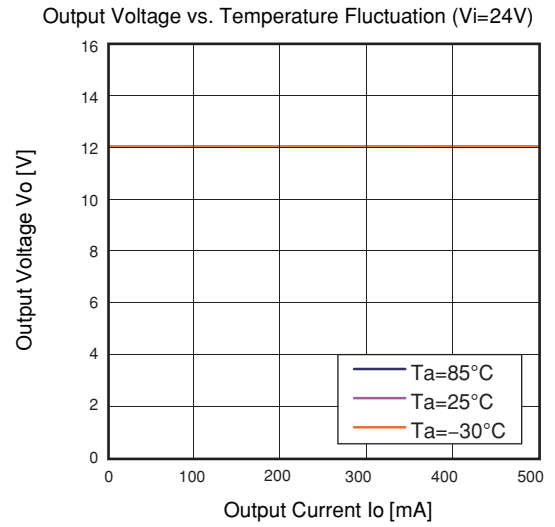
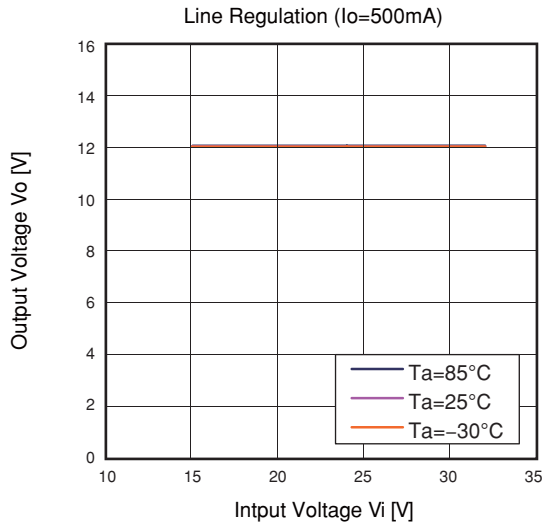

● BP5277-13

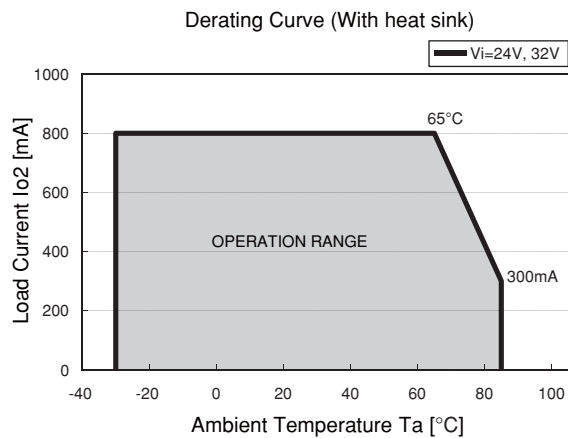
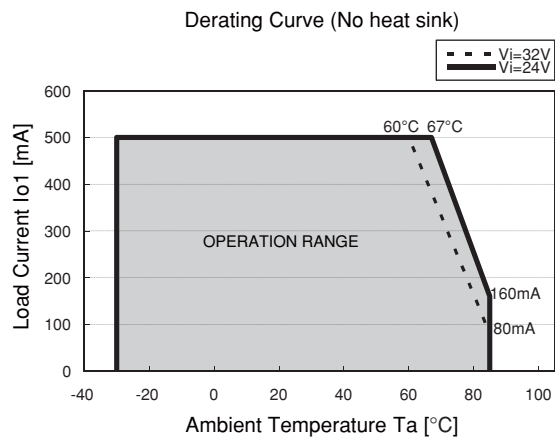
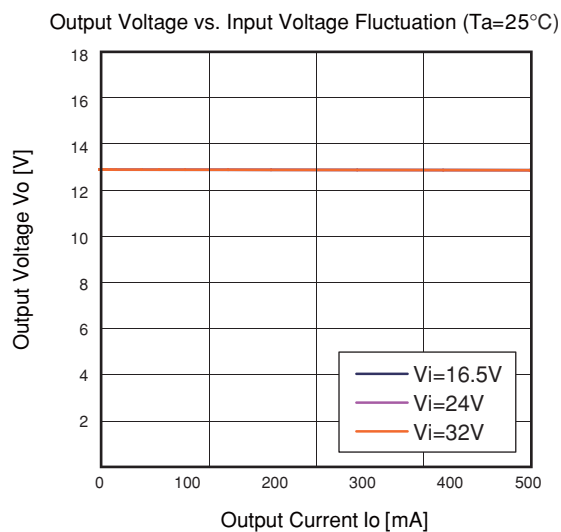
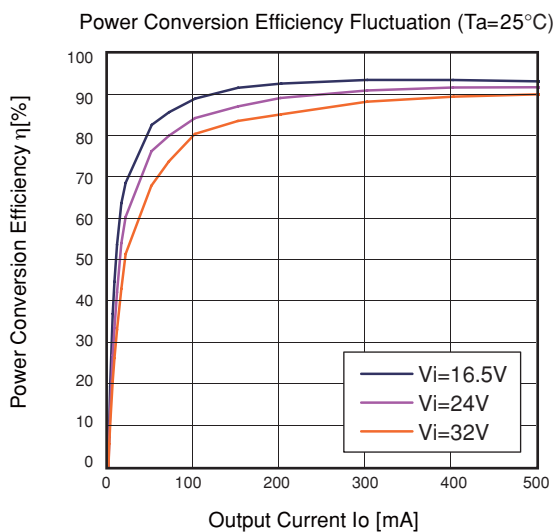
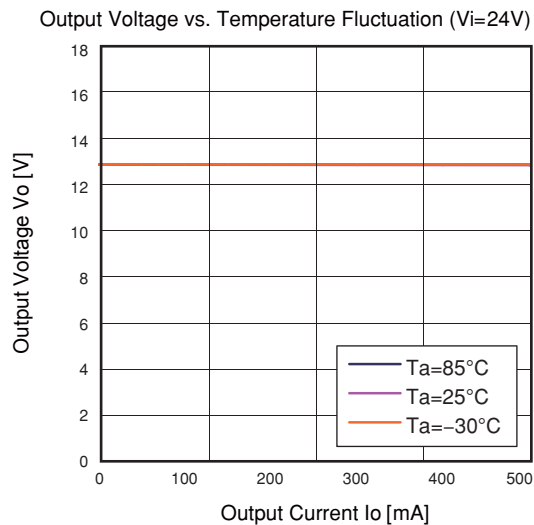
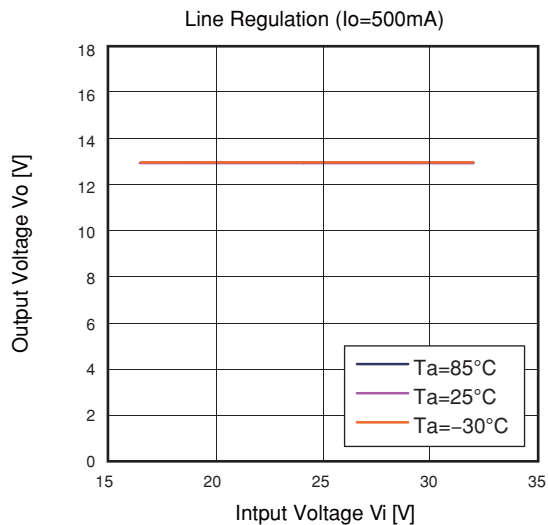

●BP5277-15

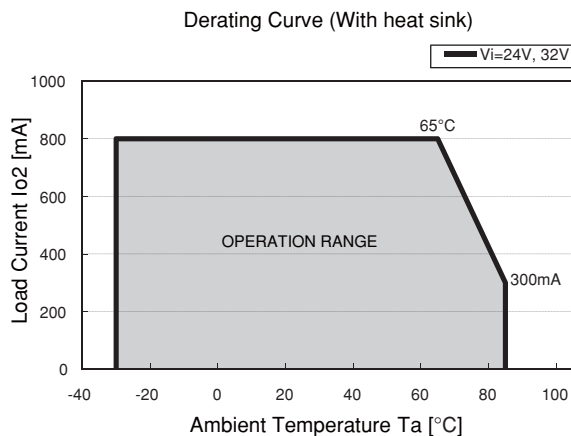
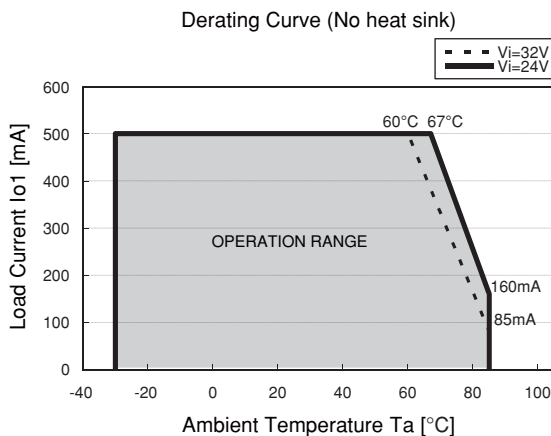
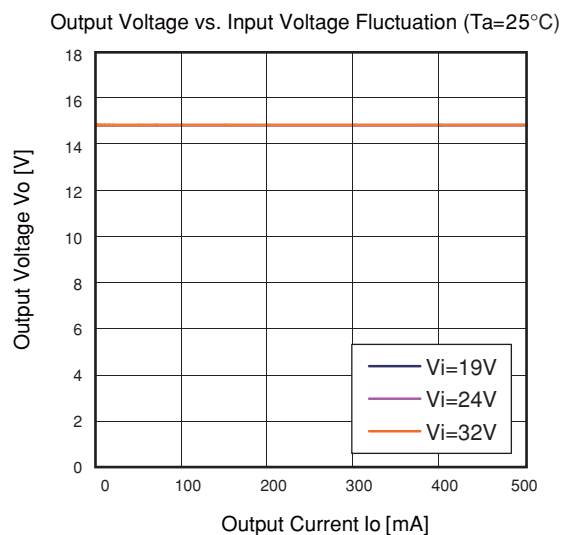
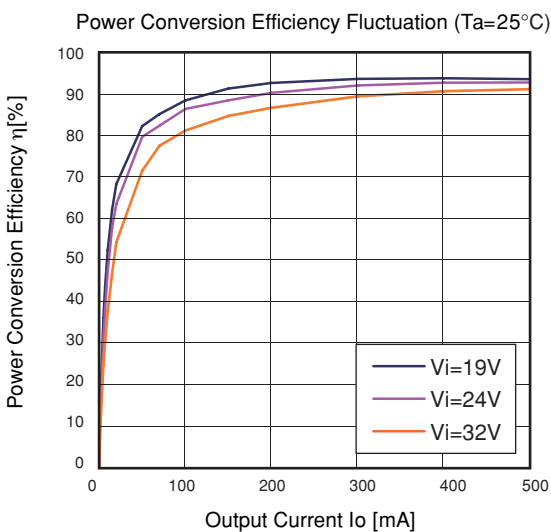
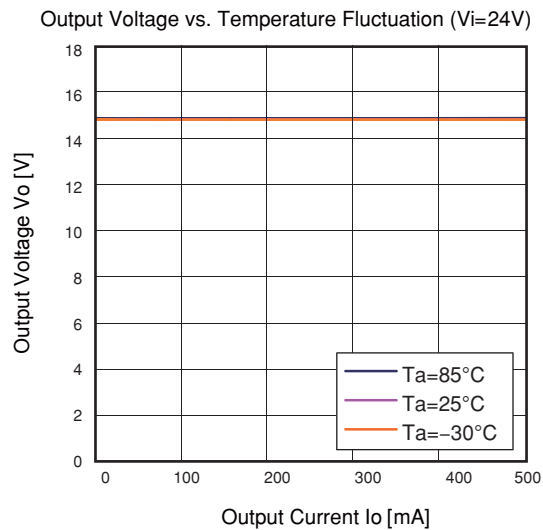
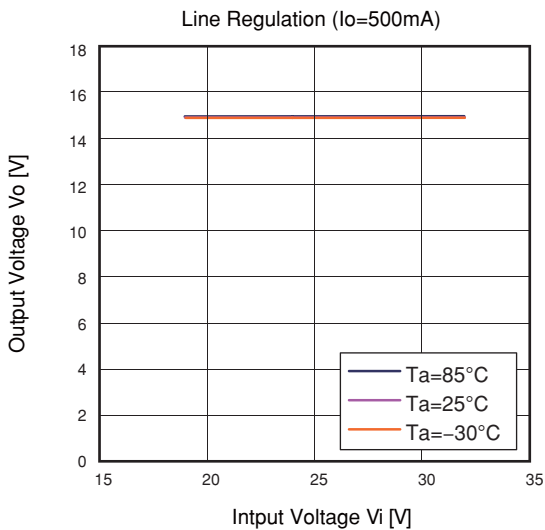

Notes

No copying or reproduction of this document, in part or in whole, is permitted without the consent of ROHM Co.,Ltd.

The content specified herein is subject to change for improvement without notice.

The content specified herein is for the purpose of introducing ROHM's products (hereinafter "Products"). If you wish to use any such Product, please be sure to refer to the specifications, which can be obtained from ROHM upon request.

Examples of application circuits, circuit constants and any other information contained herein illustrate the standard usage and operations of the Products. The peripheral conditions must be taken into account when designing circuits for mass production.

Great care was taken in ensuring the accuracy of the information specified in this document. However, should you incur any damage arising from any inaccuracy or misprint of such information, ROHM shall bear no responsibility for such damage.

The technical information specified herein is intended only to show the typical functions of and examples of application circuits for the Products. ROHM does not grant you, explicitly or implicitly, any license to use or exercise intellectual property or other rights held by ROHM and other parties. ROHM shall bear no responsibility whatsoever for any dispute arising from the use of such technical information.

The Products specified in this document are intended to be used with general-use electronic equipment or devices (such as audio visual equipment, office-automation equipment, communication devices, electronic appliances and amusement devices).

The Products specified in this document are not designed to be radiation tolerant.

While ROHM always makes efforts to enhance the quality and reliability of its Products, a Product may fail or malfunction for a variety of reasons.

Please be sure to implement in your equipment using the Products safety measures to guard against the possibility of physical injury, fire or any other damage caused in the event of the failure of any Product, such as derating, redundancy, fire control and fail-safe designs. ROHM shall bear no responsibility whatsoever for your use of any Product outside of the prescribed scope or not in accordance with the instruction manual.

The Products are not designed or manufactured to be used with any equipment, device or system which requires an extremely high level of reliability the failure or malfunction of which may result in a direct threat to human life or create a risk of human injury (such as a medical instrument, transportation equipment, aerospace machinery, nuclear-reactor controller, fuel-controller or other safety device). ROHM shall bear no responsibility in any way for use of any of the Products for the above special purposes. If a Product is intended to be used for any such special purpose, please contact a ROHM sales representative before purchasing.

If you intend to export or ship overseas any Product or technology specified herein that may be controlled under the Foreign Exchange and the Foreign Trade Law, you will be required to obtain a license or permit under the Law.



Thank you for your accessing to ROHM product informations.
More detail product informations and catalogs are available, please contact us.

ROHM Customer Support System

<http://www.rohm.com/contact/>