



BRIGHT LED ELECTRONICS CORP.

Total Page: 6
Page: 1
Revision: 1.2

www.DataSheet4U.com

- Customer P/N:
- Device Number: BPR-205F
- Features:
 - * Compact
 - * High performance
 - * High-speed response
 - * Easy to mount on PCB
 - * Widely applicable

Sheet Date	1	2	3	4	5	6	Contents			
2002.08.09	1.0	1.0	1.0	1.0	1.0	1.0	Initial Released			
2002.10.15	1.1	1.1	1.0	1.0	1.0	1.0	取消 BIN 級畫顏色			
2004.04.29	1.2	1.1	1.2	1.0	1.0	1.0	PIN Size:6.0mm→9.0mm			

Total Page	6																		
------------	---	--	--	--	--	--	--	--	--	--	--	--	--	--	--	--	--	--	--

佰鴻工業股份有限公司

BRIGHT LED ELECTRONICS CORP.

台北縣板橋市和平路 19 號 3 樓
3F., No. 19, Ho Ping Road, Pan Chiao City,
Taipei, Taiwan, R. O. C.



Tel: 886-2-29591090
Fax: 886-2-29547006/29558809

www.brtled.com

廣東省東莞市高步鎮蘆溪管理區高龍東路八號
No.8 Gaolong east way Luxi precinctGaobu
Town Dongguan city Guangdong Province
China

Tel : 886-0769-8730255 8731855
Fax : 886-0769-8733355 8738706

www.brtled.com

Approved	Checked	Drawn
 許 2004.04.29 耀宗	 楊 2004.04.29 衛平	 溫 2004.04.29 華麗

BRIGHT LED ELECTRONICS

- Device Number: BPR-205F
- Absolute Maximum Rating (Ta=25°C)

Page: 2
Version: 1.1

Item		Symbol	Rating	Unit
Input	Power Dissipation	Pd	75	mW
	Reverse Voltage	V _R	5	V
	Forward Current	I _F	50	mA
	Peak Forward Current (*1)	I _{FP}	1	A
Output	Collector Power Dissipation	P _C	100	mW
	Collector Current	I _C	20	mA
	C-E Voltage	V _{CEO}	20	V
	E-C Voltage	V _{ECO}	5	V
Operating Temperature		Topr	-25 ~ +85	°C
Storage Temperature		Tstg	-30 ~ +100	°C
Soldering Temperature (*2)		Tsol	260	°C

(*1) tw=100 uSec. 、 T=10 mSec.

(*2) t=3 Sec

● Electrical Optical Characteristics (Ta=25°C)

Parameter		Symbol	Condition	Min.	Typ.	Max.	Unit	BIN NO
Input	Forward Voltage	V _F	I _F =10mA	1.0	1.2	1.4	V	
	Reverse Current	I _R	V _R =5V	—	—	10	μA	
Output	Dark Current	I _D	V _{CE} =10V	—	—	1	μA	
	C-E Saturation Voltage	V _{CE(sat)}	I _C =0.9mA I _F =5.0mA	—	0.8	1.2	V	
Light Current		I _L	V _{CE} =5V I _F =5.0mA D=1.0mm (90% Reflective white paper)	0.5	—	1.10	mA	BIN A
				0.86	—	1.90		BIN B
				1.45	—	2.65		BIN C
				2.35	—	5.20		BIN D
				4.80	—	8.90		BIN E
				6.80	—	15.0		BIN F
Leakage Current		I _{LEAK}	I _F =5.0mA V _{CE} =5V	—	—	5	μA	
Speed	Rise Time	Tr	I _C =10mA V _{CE} =5V	—	20	—	μsec	
	Fall Time	Tf	R _L =1000Ω	—	20	—	μsec	

BRIGHT LED ELECTRONICS

- Device Number: BPR-205F
- Package Dimensions

Page: 3
Version: 1.2

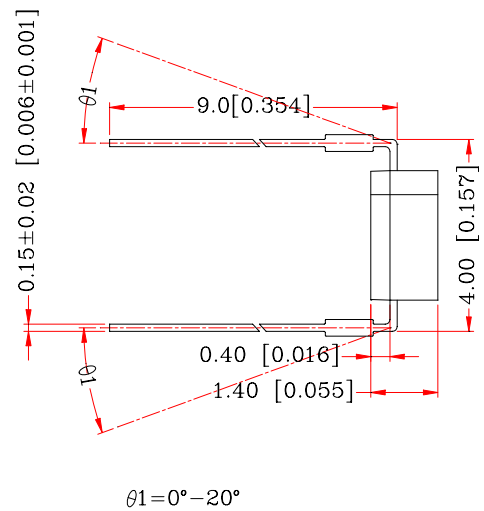
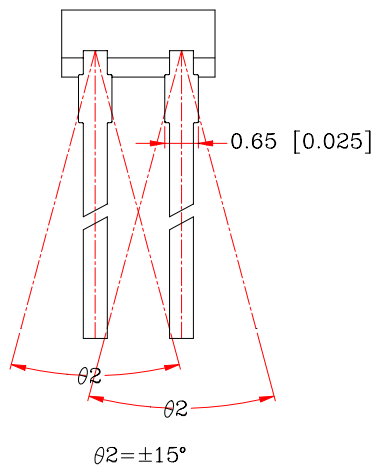
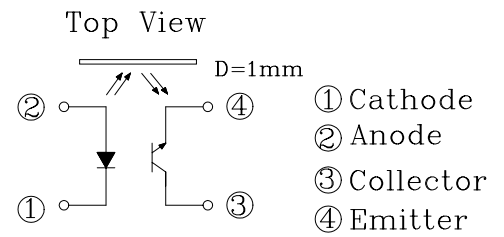
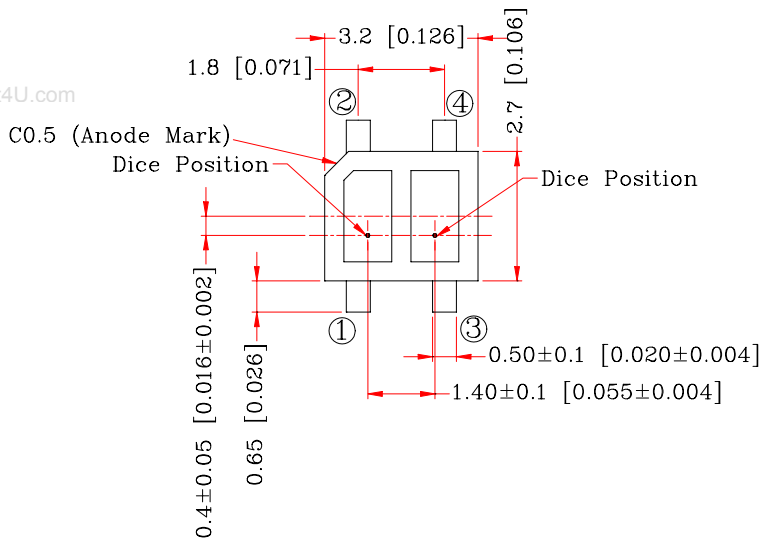

Notes:

1. All dimensions are in millimeters (inches).
2. Tolerance is ± 0.25 mm unless otherwise specified.
3. Lead spacing is measured where the leads emerge from the package.
4. Specifications are subject to change without notice.

BRIGHT LED ELECTRONICS

● Device Number: BPR-205F
 ● Typical Electrical / Optical Characteristics Curves (Ta=25°C)

Page: 4
 Version: 1.0

www.DataSheet4U.com Fig.1 Power Dissipation vs. Ambient Temperature

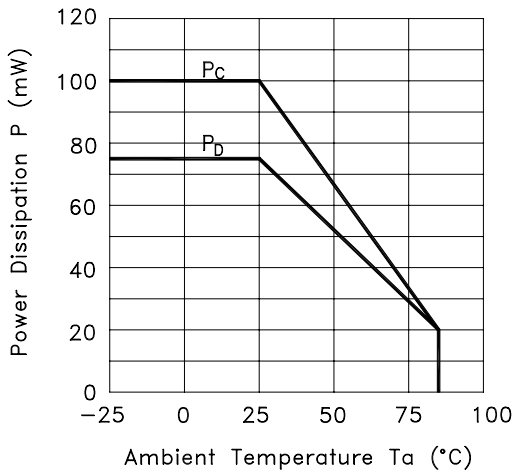

Fig.2 Forward Current vs. Forward Voltage

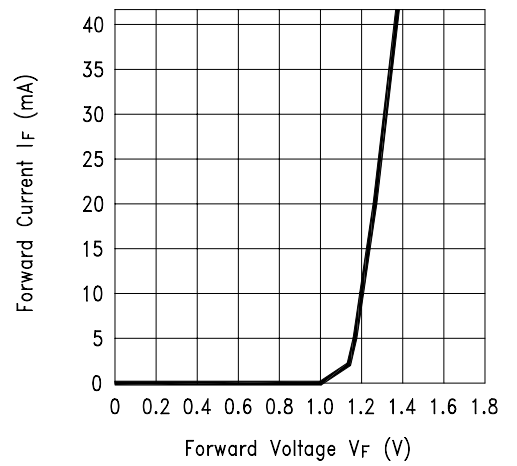

Fig.3 Collector Current vs. Collector-emitter Voltage

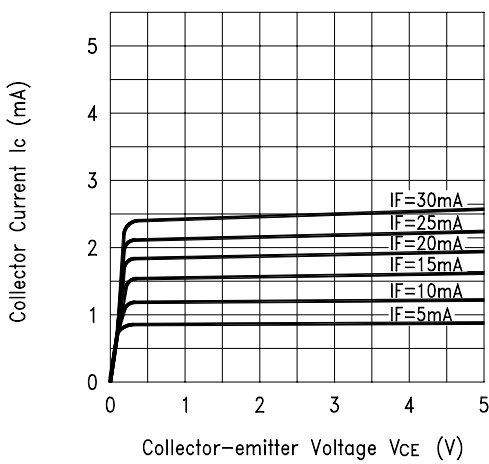
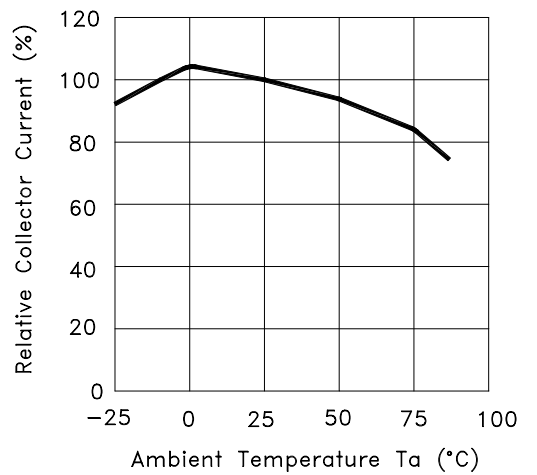

Fig.4 Collector Current vs. Ambient Temperature



BRIGHT LED ELECTRONICS

- Device Number: BPR-205F
- Typical Electric / Optical Characteristics Curves (Ta=25°C)

Page: 5
Version: 1.0

Fig.5 Collector-emitter Saturation Voltage vs. Ambient Temperature

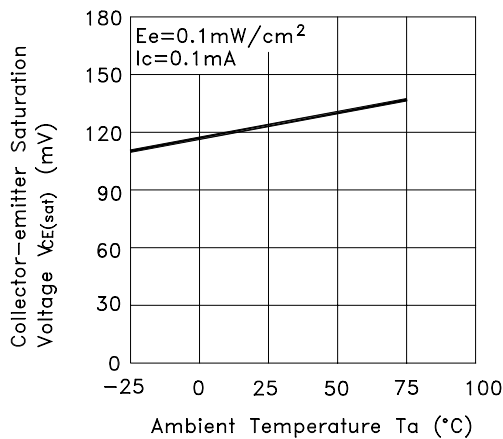

Fig.6 Response Time vs. Load Resistance

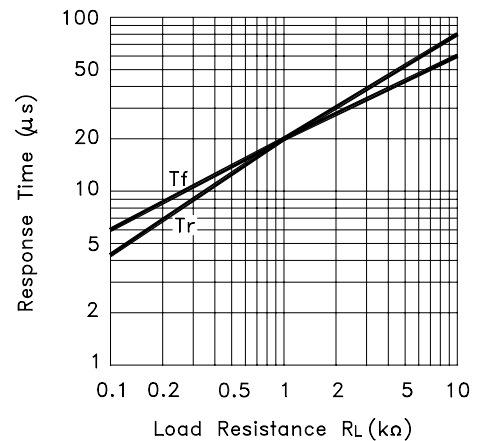
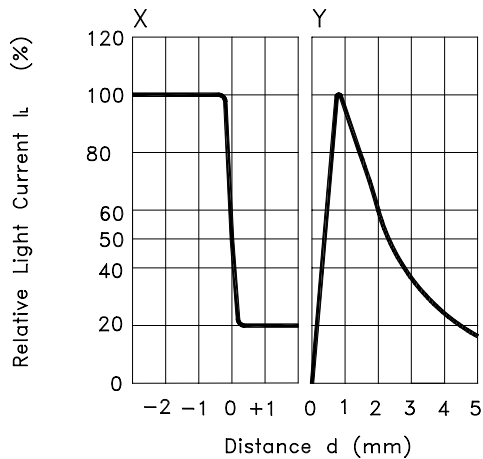
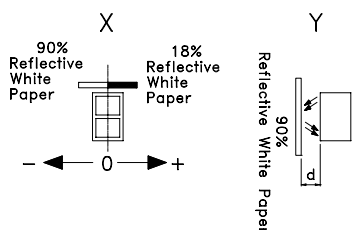

Fig.7 Sensing Position Characteristics (Typical)



(Center of Optical axis)



Test Circuit for Response Time

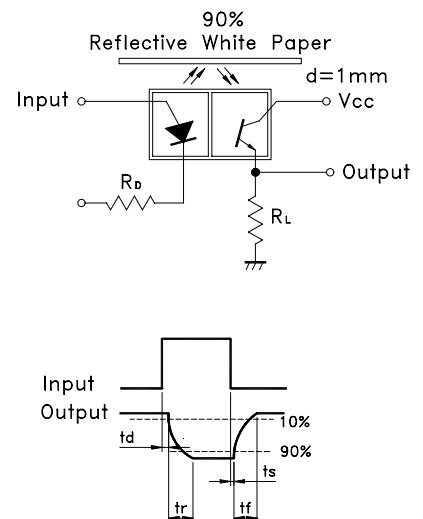

BRIGHT LED ELECTRONICS

- Device Number : BPR-205F
- Packaging Box Dimensions

Page: 6
Version: 1.0

www.DataSheet4U.com

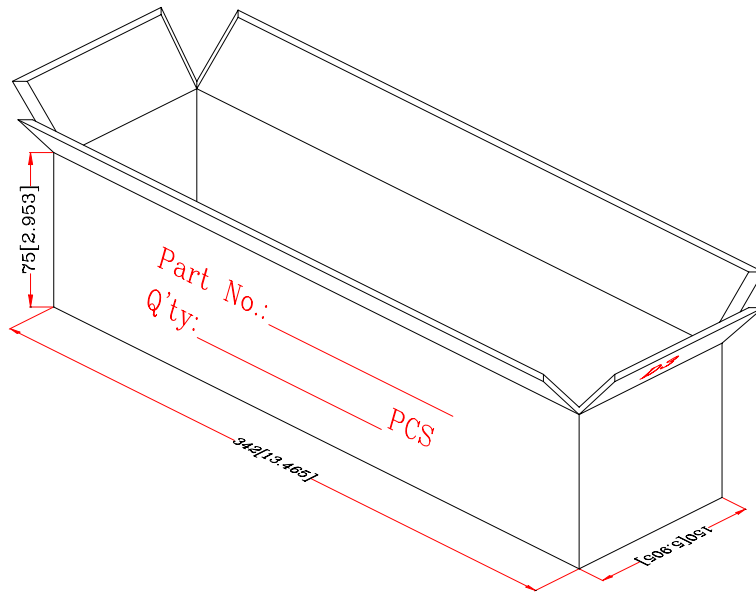

- Packaging Tube Dimensions

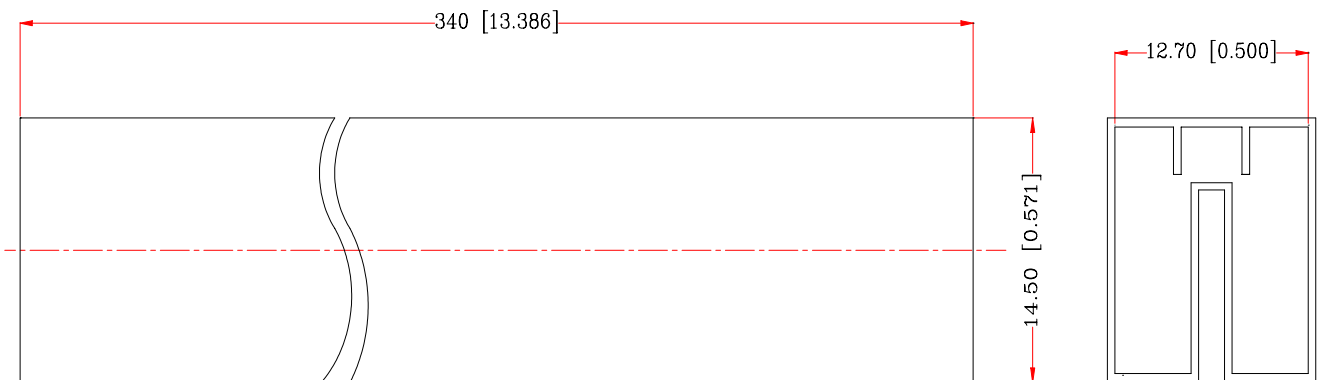

Notes:

1. 100pcs per tube, 2kpcs per box.
2. All Dimensions are in millimeters (inches).
3. Specifications are subject to change without notice.