

Silicon PIN Photodiode with Daylight Blocking Filter

Version 1.4

BPW 34 FS

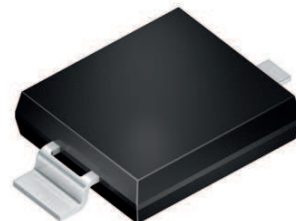

Features:

- Especially suitable for the wavelength range of 780 nm to 1100 nm
- Short switching time (typ. 20 ns)
- DIL plastic package with high packing density
- Suitable for reflow soldering
- The product qualification test plan is based on the guidelines of AEC-Q101-REV-C, Stress Test Qualification for Automotive Grade Discrete Semiconductors.

Applications

- Automotive (eg rain sensor, headset)
- IR remote control of hi-fi and TV sets, dimmers, remote controls of various equipment
- Photointerrupters

Ordering Information

Type:	Photocurrent I_P [μA] $\lambda = 950 \text{ nm}$, $E_e = 1 \text{ mW/cm}^2$, $V_R = 5 \text{ V}$	Ordering Code
BPW 34 FS	50 (≥ 40)	Q65110A2700

Maximum Ratings ($T_A = 25\text{ °C}$)

Parameter	Symbol	Values	Unit
Operating and storage temperature range	$T_{op}; T_{stg}$	-40 ... 100	°C
Reverse voltage	V_R	16	V
Reverse voltage ($t < 2\text{ min}$)	V_R	32	V
Total Power dissipation	P_{tot}	150	mW
ESD withstand voltage (acc. to ANSI/ ESDA/ JEDEC JS-001 - HBM)	V_{ESD}	2000	V

Characteristics ($T_A = 25\text{ °C}$)

Parameter	Symbol	Values	Unit
Photocurrent ($V_R = 5\text{ V}$, $\lambda = 950\text{ nm}$, $E_e = 1\text{ mW/cm}^2$)	I_P (typ (min))	50 (≥ 40)	μA
Wavelength of max. sensitivity	$\lambda_{S\text{ max}}$ (typ)	950	nm
Spectral range of sensitivity	$\lambda_{10\%}$ (typ)	(typ) 780 ... 1100	nm
Radiant sensitive area	A (typ)	7.02	mm^2
Dimensions of radiant sensitive area	$L \times W$ (typ)	2.65 x 2.65	mm x mm
Half angle	φ (typ)	± 60	°
Dark current ($V_R = 10\text{ V}$)	I_R (typ (max))	2 (≤ 30)	nA
Spectral sensitivity of the chip ($\lambda = 950\text{ nm}$)	$S_{\lambda\text{ typ}}$ (typ)	0.7	A / W
Quantum yield of the chip ($\lambda = 950\text{ nm}$)	η (typ)	0.91	Electrons / Photon
Open-circuit voltage ($E_e = 0.5\text{ mW/cm}^2$, $\lambda = 950\text{ nm}$)	V_O (typ (min))	330 (≥ 275)	mV
Short-circuit current ($E_e = 0.5\text{ mW/cm}^2$, $\lambda = 950\text{ nm}$)	I_{SC} (typ)	25	μA
Rise and fall time ($V_R = 5\text{ V}$, $R_L = 50\ \Omega$, $\lambda = 850\text{ nm}$, $I_P = 800\ \mu\text{A}$)	t_r, t_f (typ)	0.02	μs
Forward voltage ($I_F = 100\text{ mA}$, $E = 0$)	V_F (typ)	1.3	V
Capacitance ($V_R = 0\text{ V}$, $f = 1\text{ MHz}$, $E = 0$)	C_0 (typ)	72	pF
Temperature coefficient of V_O	TC_V (typ)	-2.6	mV / K

Parameter		Symbol	Values	Unit
Temperature coefficient of I_{SC} ($\lambda = 950 \text{ nm}$)	(typ)	TC_1	0.18	% / K
Noise equivalent power ($V_R = 10 \text{ V}$, $\lambda = 950 \text{ nm}$)	(typ)	NEP	0.036	$\text{pW} / \text{Hz}^{1/2}$
Detection limit ($V_R = 10 \text{ V}$, $\lambda = 950 \text{ nm}$)	(typ)	D^*	7.3×10^{12}	$\text{cm} \times \text{Hz}^{1/2} / \text{W}$

Relative Spectral Sensitivity ^{1) page 12}

$$S_{rel} = f(\lambda)$$

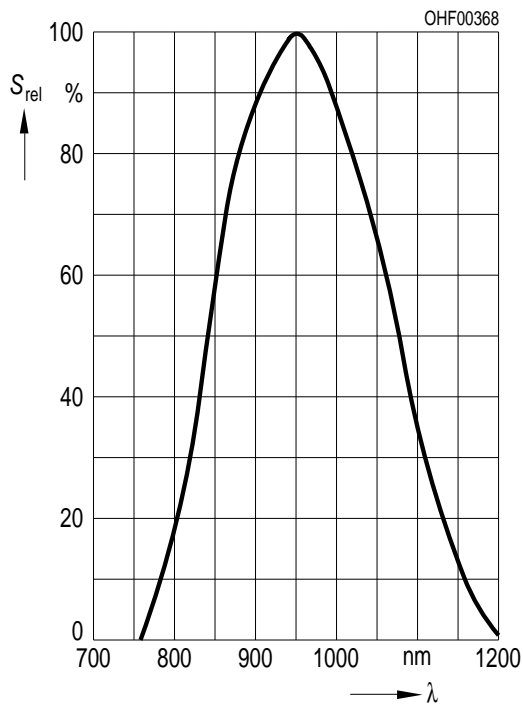

Photocurrent / Open-Circuit Voltage ^{1) page 12}

$$I_P (V_R = 5 \text{ V}) / V_O = f(E_e)$$

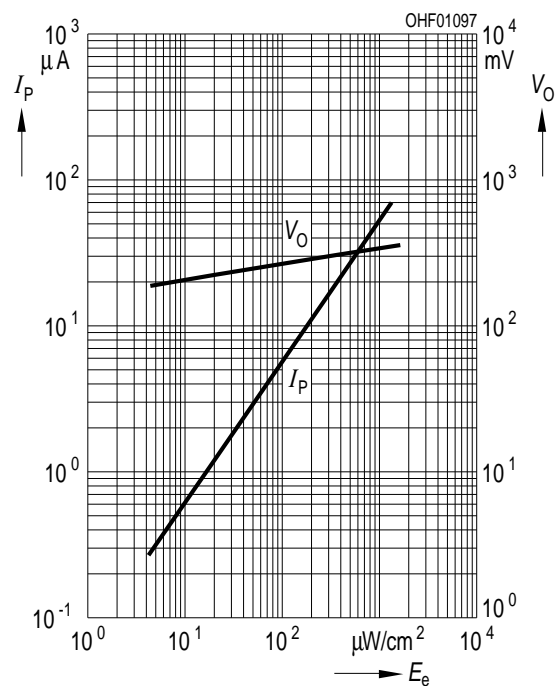

Power Consumption

$P_{tot} = f(T_A)$

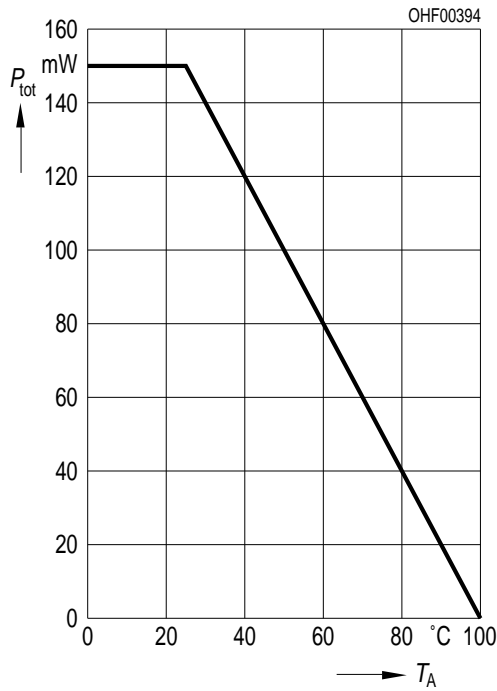

Dark Current ^{1) page 12}

$I_R = f(V_R), E = 0$

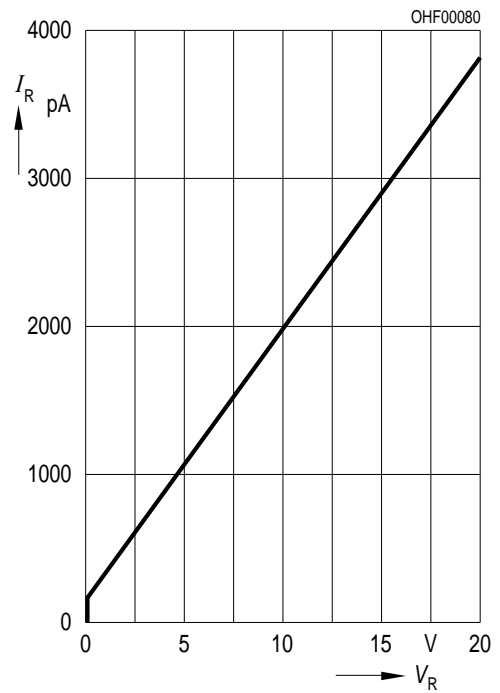

Capacitance ^{1) page 12}

$C = f(V_R), f = 1 \text{ MHz}, E = 0$

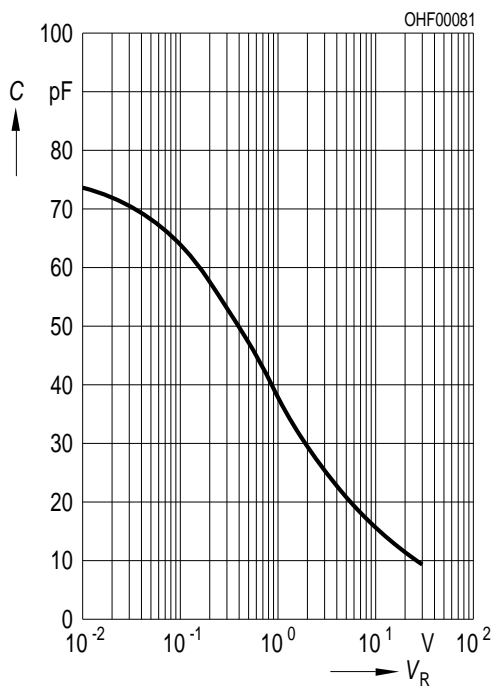

Dark Current ^{1) page 12}

$I_R = f(T_A), V_R = 10 \text{ V}, E = 0$

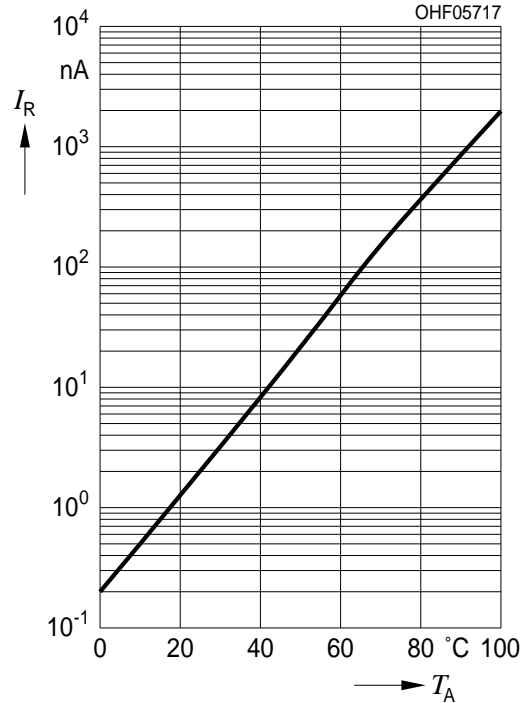

Directional Characteristics ^{1) page 12}

$S_{rel} = f(\phi)$

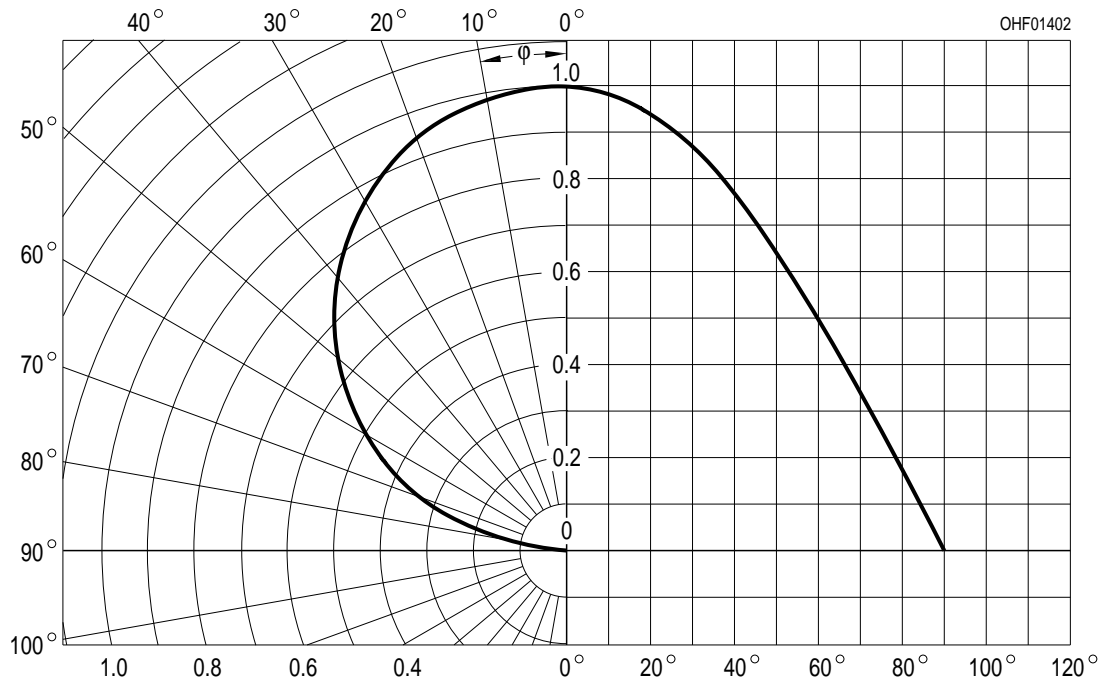

Package Outline

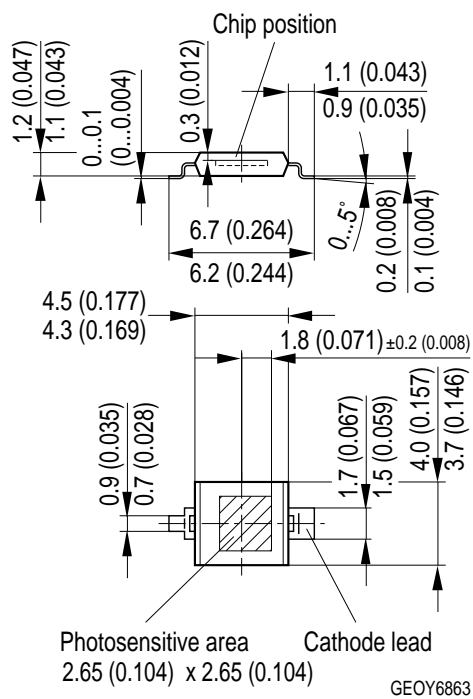

Dimensions in mm (inch).

Package

SMT DIL, Epoxy

Approximate Weight:
43 mg

Recommended Solder Pad

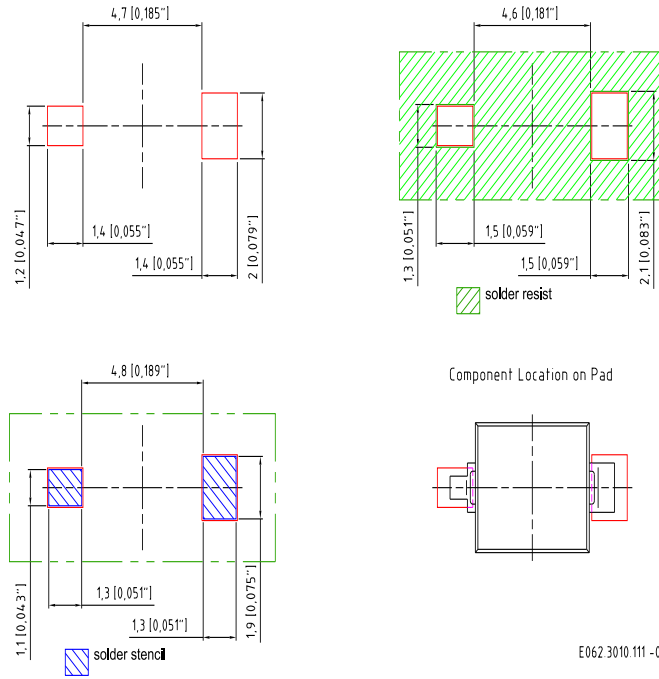

Dimensions in mm (inch).

Reflow Soldering Profile

Product complies to MSL Level 4 acc. to JEDEC J-STD-020D.01

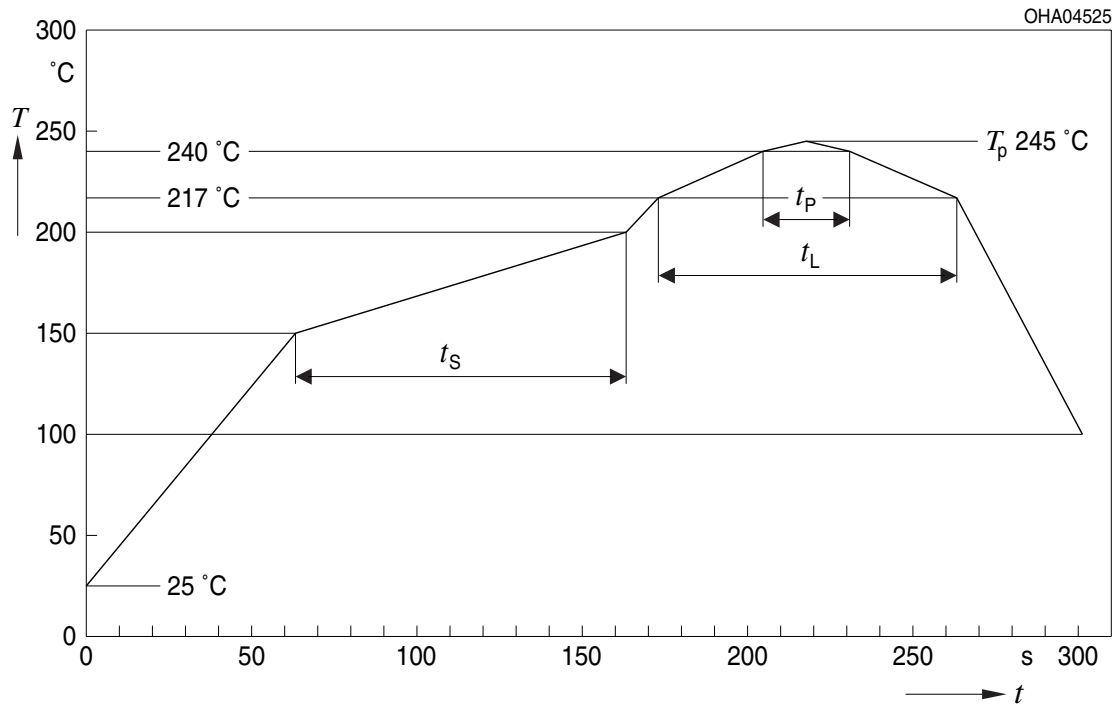

OHA04612

Profile Feature Profil-Charakteristik	Symbol Symbol	Pb-Free (SnAgCu) Assembly			Unit Einheit
		Minimum	Recommendation	Maximum	
Ramp-up rate to preheat*) 25 °C to 150 °C			2	3	K/s
Time t_S T_{Smin} to T_{Smax}	t_S	60	100	120	s
Ramp-up rate to peak*) T_{Smax} to T_P			2	3	K/s
Liquidus temperature	T_L	217			°C
Time above liquidus temperature	t_L		80	100	s
Peak temperature	T_P		245	260	°C
Time within 5 °C of the specified peak temperature $T_P - 5$ K	t_P	10	20	30	s
Ramp-down rate* T_P to 100 °C			3	6	K/s
Time 25 °C to T_P				480	s

All temperatures refer to the center of the package, measured on the top of the component

* slope calculation DT/Dt : Dt max. 5 s; fulfillment for the whole T-range

Taping

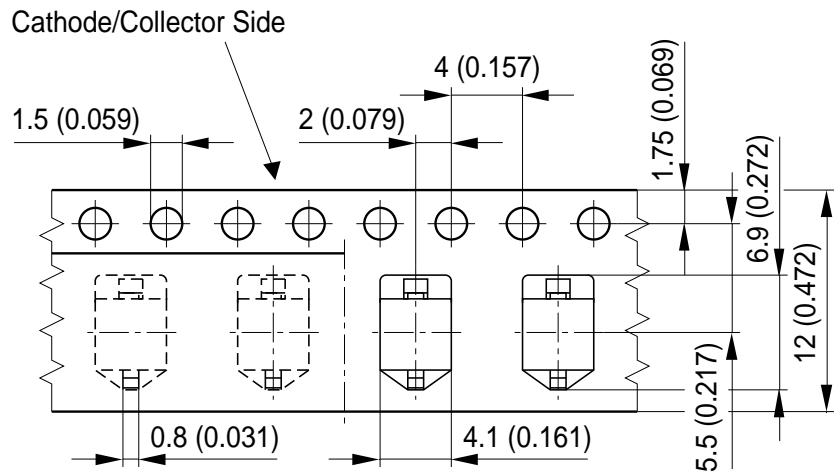

OHAY2287

Dimensions in mm (inch).

Tape and Reel

12 mm tape with 1500 pcs. on Ø 180 mm reel

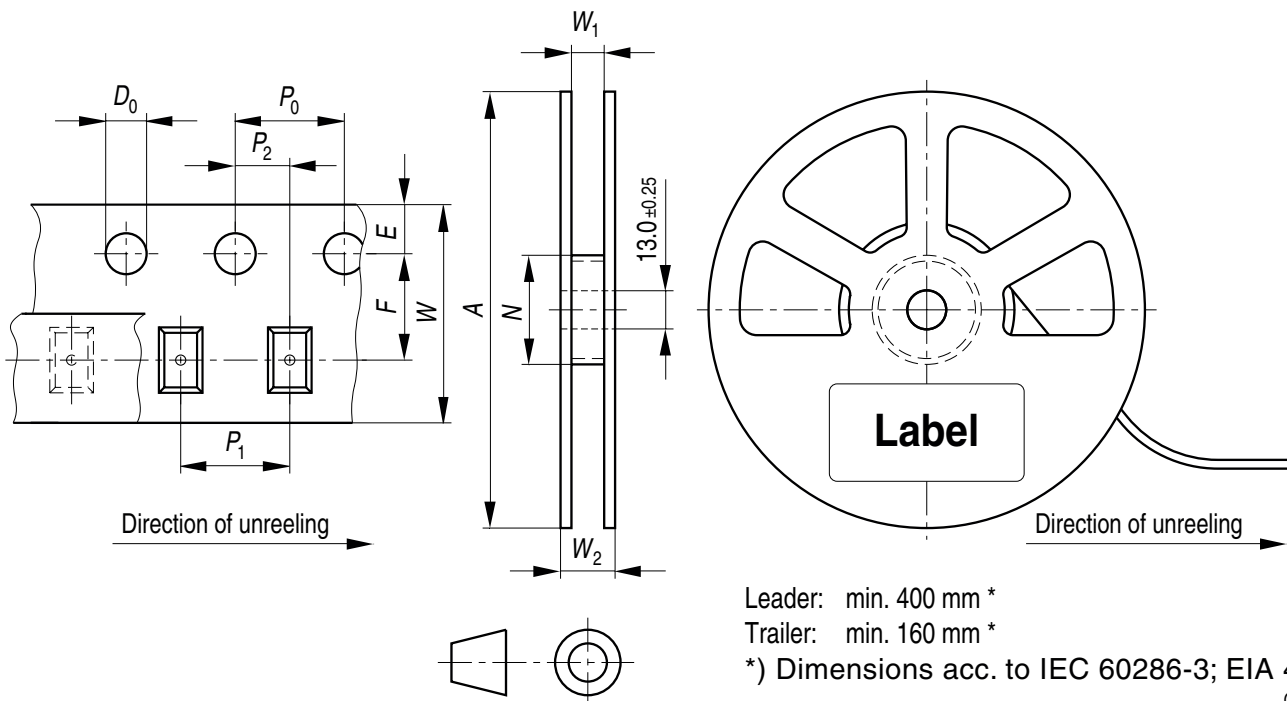

Tape dimensions [mm]

W	P ₀	P ₁	P ₂	D ₀	E	F
12 + 0.3 / - 0.1	4 ± 0.1	4 ± 0.1 or 8 ± 0.1	2 ± 0.05	1.5 ± 0.1	1.75 ± 0.1	5.5 ± 0.05

Reel dimensions [mm]

A	W	N _{min}	W ₁	W _{2max}
180	12	60	12.4 + 2	18.4

Barcode-Product-Label (BPL)

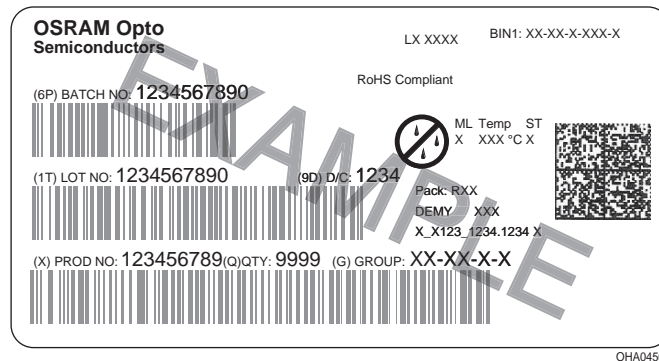

Dry Packing Process and Materials

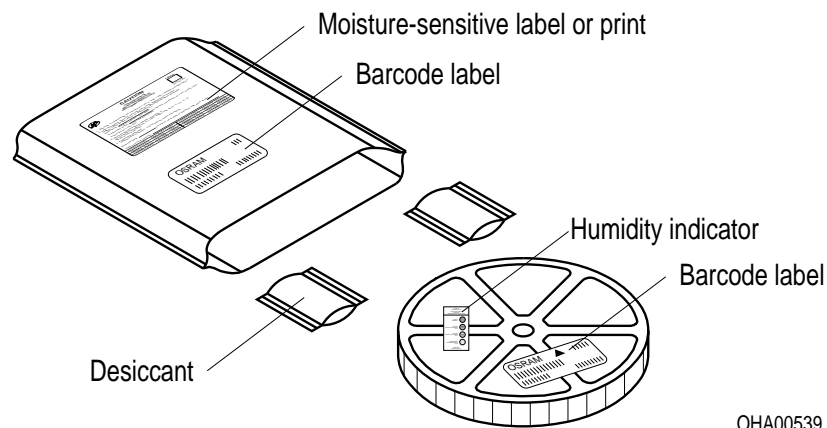

Note:

Moisture-sensitive product is packed in a dry bag containing desiccant and a humidity card. Regarding dry pack you will find further information in the internet. Here you will also find the normative references like JEDEC.

Transportation Packing and Materials

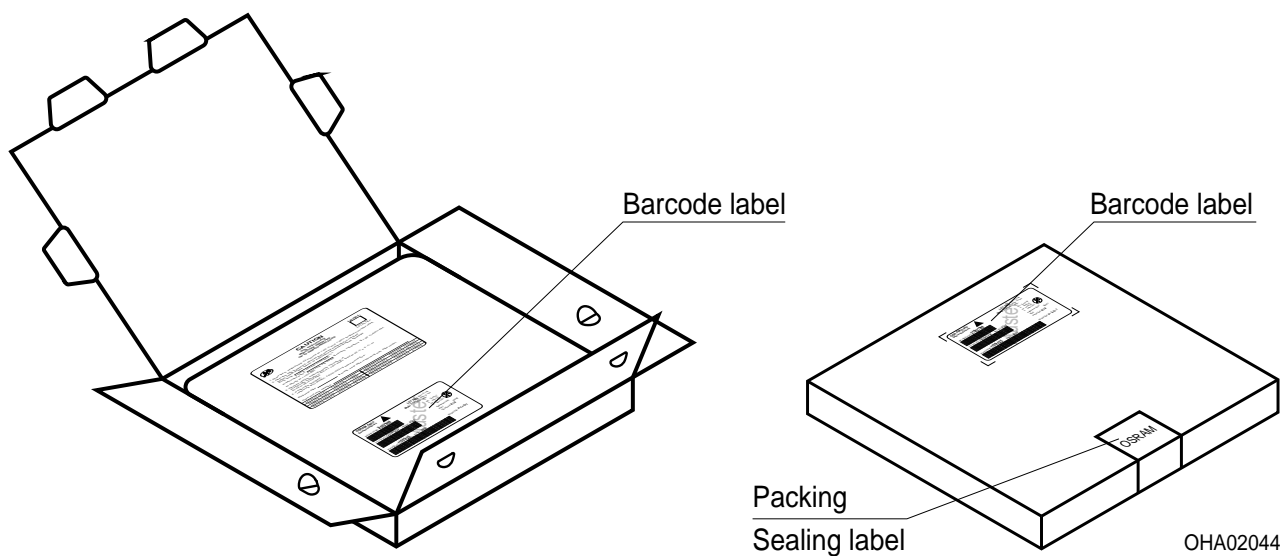

Dimensions of transportation box in mm

Width	Length	Height
195 ± 5	195 ± 5	30 ± 5

Disclaimer

Language english will prevail in case of any discrepancies or deviations between the two language wordings.

Attention please!

The information describes the type of component and shall not be considered as assured characteristics.

Terms of delivery and rights to change design reserved. Due to technical requirements components may contain dangerous substances.

For information on the types in question please contact our Sales Organization.

If printed or downloaded, please find the latest version in the Internet.

Packing

Please use the recycling operators known to you. We can also help you – get in touch with your nearest sales office.

By agreement we will take packing material back, if it is sorted. You must bear the costs of transport. For packing material that is returned to us unsorted or which we are not obliged to accept, we shall have to invoice you for any costs incurred.

Components used in life-support devices or systems must be expressly authorized for such purpose!

Critical components* may only be used in life-support devices** or systems with the express written approval of OSRAM OS.

*) A critical component is a component used in a life-support device or system whose failure can reasonably be expected to cause the failure of that life-support device or system, or to affect its safety or the effectiveness of that device or system.

**) Life support devices or systems are intended (a) to be implanted in the human body, or (b) to support and/or maintain and sustain human life. If they fail, it is reasonable to assume that the health and the life of the user may be endangered.

Glossary

- ¹⁾ **Typical Values:** Due to the special conditions of the manufacturing processes of LED, the typical data or calculated correlations of technical parameters can only reflect statistical figures. These do not necessarily correspond to the actual parameters of each single product, which could differ from the typical data and calculated correlations or the typical characteristic line. If requested, e.g. because of technical improvements, these typ. data will be changed without any further notice.

Published by OSRAM Opto Semiconductors GmbH
Leibnizstraße 4, D-93055 Regensburg
www.osram-os.com © All Rights Reserved.

EU RoHS and China RoHS compliant product



此产品符合欧盟 RoHS 指令的要求；
按照中国的相关法规和标准，不含有毒有害物质或元素。