

BR1000 THRU BR5010

List

List..... 1

Package outline..... 2

Features..... 2

Mechanical data..... 2

Maximum ratings 3

Rating and characteristic curves..... 4

Marking..... 4

Bulk packing..... 5

Suggested thermal profiles for soldering processes..... 5

High reliability test capabilities.....6

BR1000 THRU BR5010

10.0A ~ 50.0A Single-Phase Bridge Rectifiers - 50V-1000V

Package outline

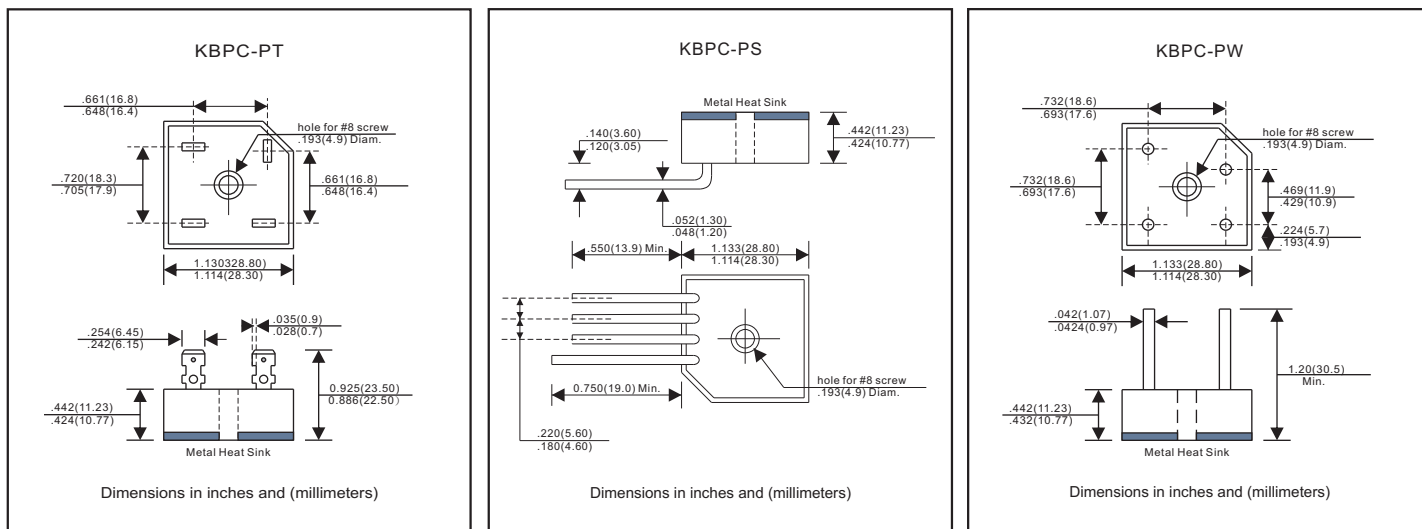

Features

- Surge overload ratings to 400 amperes peak.
- Low Forward drop voltage & reverse leakage current.
- Integrally molded heatsink provides very low thermal Resistance for maximum heat dissipation
- Universal 3-way terminals for selection, faston terminals wire leads and wire-lead single in line.
- Open junction chip cells inside
- Lead-free parts meet RoHS requirements.
- UL recognized file # E321971
- Suffix "-H" indicates Halogen free parts, ex. BR1000-T-H.

Mechanical data

- Epoxy:UL94-V0 rated flame retardant
- Case : Molded plastic, KBPC-P case with heatsink
- Terminals : Solder plated, solderable per MIL-STD-750, Method 2026
- Polarity : marked on side body
- Mounting Position : Hole thru for #10 screw(Note A)
- Mounting Torque: 20 in-lb (23cm-kg) max.
- Weight : KBPC-PT , 0.74 ounce, 21 grams
KBPC-PS, 0.63 ounce, 18 grams
KBPC-PW, 0.63 ounce, 18 grams

Part Numbering

BR10 01 - T

Lead Types,
T : faston terminals
W : wire leads
S : wire-lead single in line

Reverse Voltage,
00: 50V 01: 100V 02: 200V
04: 400V 06: 600V 08: 800V
10: 1000V 12: 1200V

Forward Rectified Output Current,
10: 10.0A 15: 15.0A 25: 25.0A
35: 35.0A 40: 40.0A 50: 50.0A

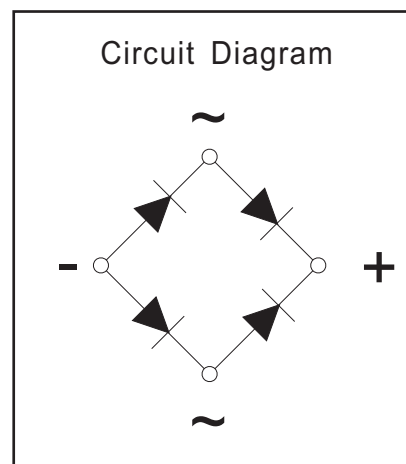

BR1000 THRU BR5010

Maximum ratings (AT $T_A=25^{\circ}\text{C}$ unless otherwise noted)

BRXX, XX=10, 15, 25, 35, 40 or 50	Symbols	BR xx00	BR xx01	BR xx02	BR xx04	BR xx06	BR xx08	BR xx10	Unit
Maximum Recurrent Peak Reverse Voltage	VRRM	50	100	200	400	600	800	1000	Volts
Maximum RMS Voltage	VRMS	35	70	140	280	420	560	700	Volts
Maximum DC Blocking Voltage	VDC	50	100	200	400	600	800	1000	Volts
Maximum Average Forward Rectified Output Current (See Fig. 1)	BR10 BR15 BR25 BR35 BR40 BR50	I(AV)						10.0 15.0 25.0 35.0 40.0 50.0	Amps
Peak Forward Surge Current 8.3ms single half sine-wave superimposed on rated load (JEDEC Method)	BR10 BR15 BR25 BR35 BR40 BR50	IFSM						240 300 350 400 400 400	Amps
Rating (Non-Repetitive, for t greater than 1ms and less than 8.3ms) for fusing	BR10 BR15 BR25 BR35 BR40 BR50	I ² t						240 374 508 664 664 664	A ² sec
Maximum Instantaneous Forwarded Voltage Drop Per Leg at	BR10 IF= 5.0A BR15 IF= 7.5A BR25 IF=12.5A BR35 IF=17.5A BR40 IF=20.0A BR50 IF=25.0A	VF						1.0	Volts
Maximum DC Reverse Current at Rated DC Blocking Voltage	TJ= 25°C TJ=125°C	IR						5.0 500.0	μA
Operating Junction Temperature Range	TJ	-55 ~ +125						°C	
Storage Temperature Range	TSTG	-65 ~ +125						°C	

Rating and characteristic curves (BR1000 THRU BR5010)

Fig. 1 - Derating Curve Output Rectified Current

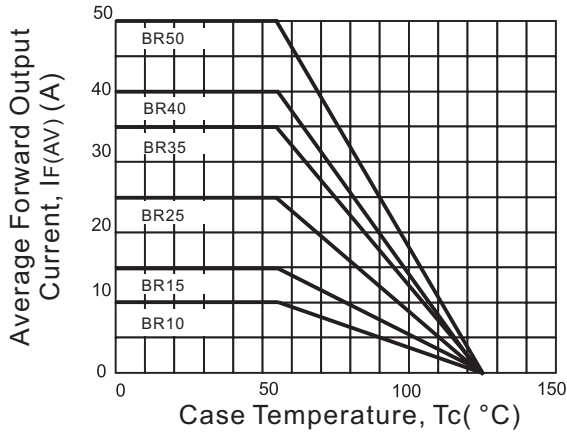

Fig. 2 - Maximum Non-Repetitive Peak Forward Surge Current

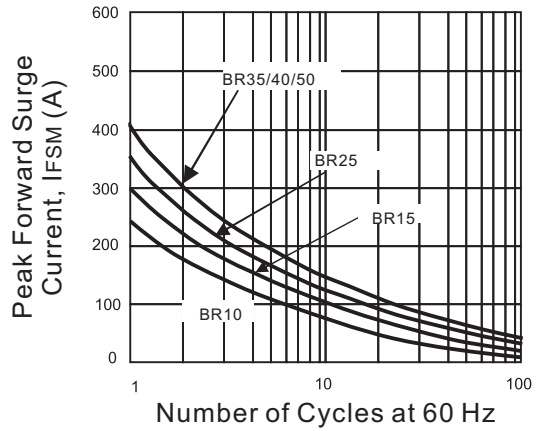

Fig. 3 - Typical Forward Characteristics

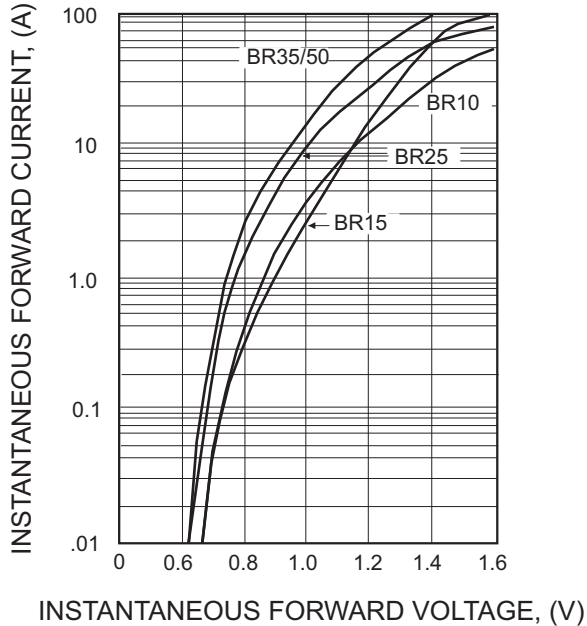
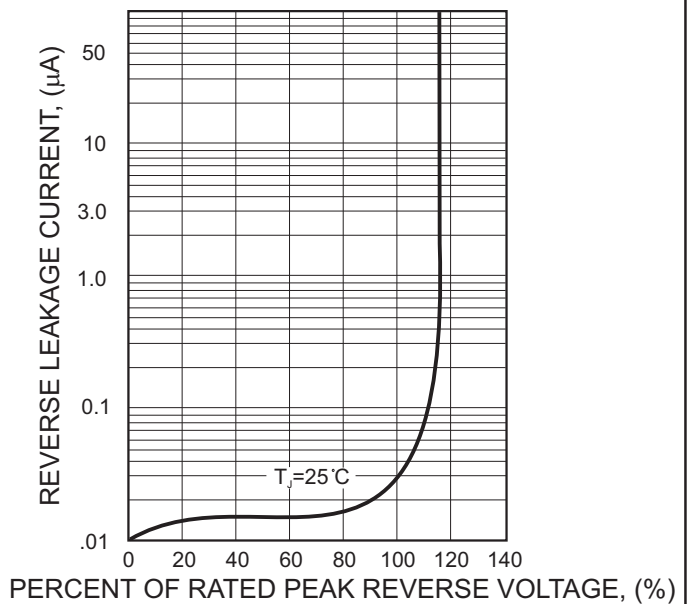

FIG.4-TYPICAL REVERSE CHARACTERISTICS



Marking

Type number	Marking code
BRXX00	BRXX00
BRXX01	BRXX01
BRXX02	BRXX02
BRXX04	BRXX04
BRXX06	BRXX06
BRXX08	BRXX08
BRXX10	BRXX10

XX=10,15, 25, 35, 40, or 50

BR1000 THRU BR5010

BULK PACKING

DEVICE CASE TYPE	Q'TY 1 (PCS / BOX)	INNER BOX SIZE (m/m)	CARTON SIZE (m/m)	Q'TY 2 (PCS / CARTON)	APPROX. CROSS WEIGHT(kg)
KBPC-PT	50	203 * 203 * 44	445 * 215 * 260	500	10.0
KBPC-PS	120	203 * 203 * 44	445 * 215 * 260	1,200	10.0
KBPC-PW	50	203 * 203 * 44	445 * 215 * 260	500	22.0

Suggested thermal profiles for soldering processes

1. Lead free temperature profile wave-soldering

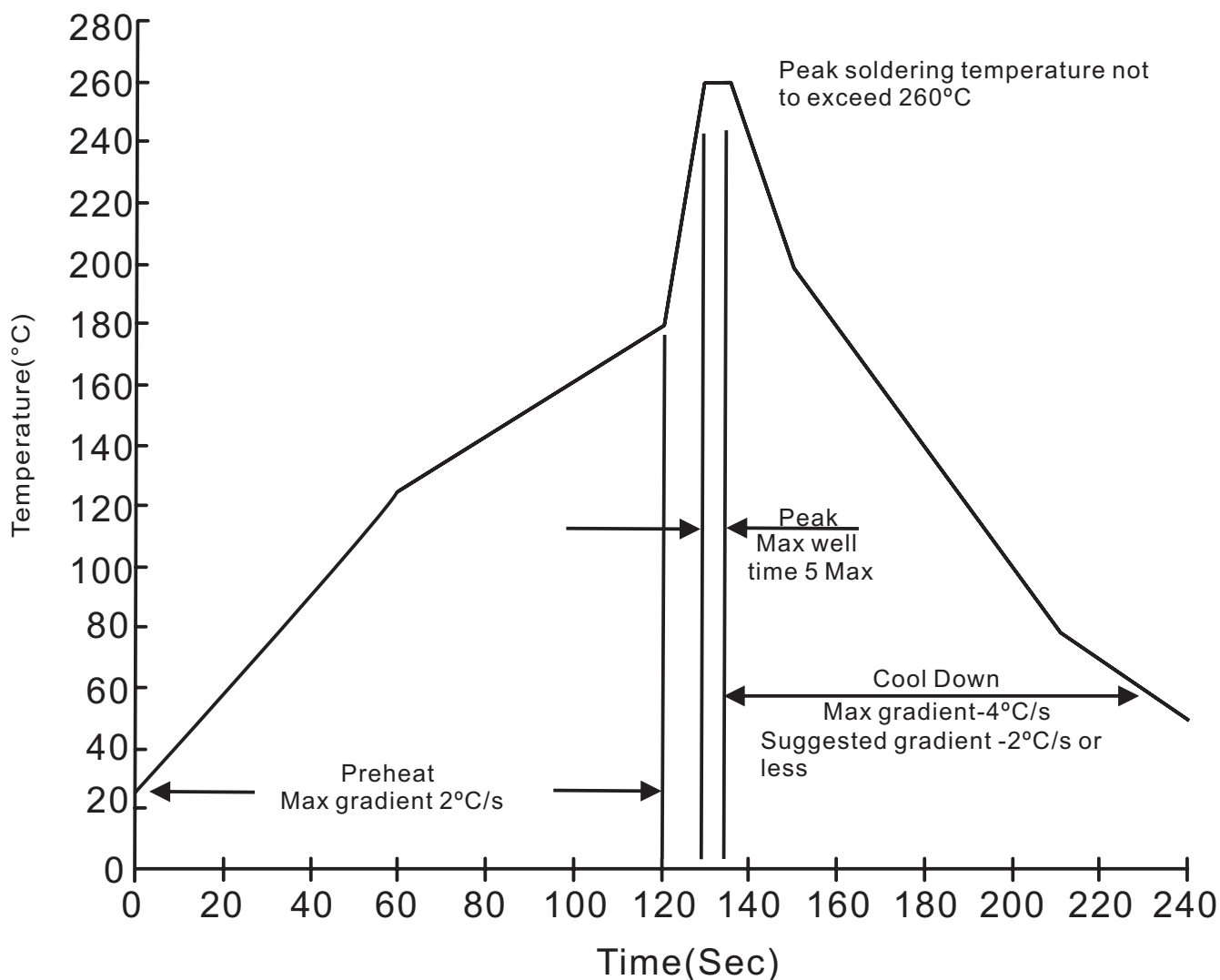

BR1000 THRU BR5010**High reliability test capabilities**

Item Test	Conditions	Reference
1. Solder Resistance	at $260\pm 5^{\circ}\text{C}$ for $10\pm 2\text{sec.}$ immerse body into solder $1/16''\pm 1/32''$	MIL-STD-750D METHOD-2031
2. Solderability	at $245\pm 5^{\circ}\text{C}$ for 5 sec.	MIL-STD-202F METHOD-208
3. High Temperature Reverse Bias	$V_R=80\%$ rate at $T_J=125^{\circ}\text{C}$ for 168 hrs.	MIL-STD-750D METHOD-1038
4. Forward Operation Life	Rated average rectifier current at $T_A=25^{\circ}\text{C}$ for 500hrs.	MIL-STD-750D METHOD-1027
5. Intermittent Operation Life	$T_A = 25^{\circ}\text{C}$, $I_F = I_o$ On state: power on for 5 min. off state: power off for 5 min. on and off for 500 cycles.	MIL-STD-750D METHOD-1036
6. Pressure Cooker	$15P_{SIG}$ at $T_A=121^{\circ}\text{C}$ for 4 hrs.	JESD22-A102
7. Temperature Cycling	-55°C to $+125^{\circ}\text{C}$ dwelled for 30 min. and transferred for 5min. total 10 cycles.	MIL-STD-750D METHOD-1051
8. Thermal Shock	0°C for 5 min. rise to 100°C for 5 min. total 10 cycles.	MIL-STD-750D METHOD-1056
9. Forward Surge	8.3ms single half sine-wave superimposed on rated load, one surge.	MIL-STD-750D METHOD-4066-2
10. Humidity	at $T_A=85^{\circ}\text{C}$, RH=85% for 1000hrs.	MIL-STD-750D METHOD-1021
11. High Temperature Storage Life	at 175°C for 1000 hrs.	MIL-STD-750D METHOD-1031