

POL Converter Module for 5 V System Intermediate Bus

Features and Benefits

- Industry standard footprint
- Improved soldering: gold-plated pads and side notches
- Synchronized rectifying type stepdown chopper
- High power
- High efficiency: 94.6% at $V_{IN} = 5\text{ V}$, $V_O = 3.3\text{ V}$, $I_O = 14\text{ A}$
- Operating temperature range: -40°C to 85°C
- Input voltage range: 4.5 to 7.0 VDC
- Output voltage: 0.75 to 3.63 V
- Output current range: 0 to 20 A
- Operating frequency: 400 kHz
- Overcurrent protection function

Package: Module

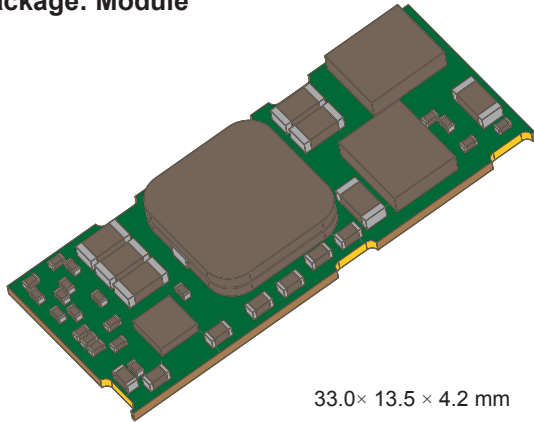

33.0 × 13.5 × 4.2 mm

Description

The BR206 is a thin type POL converter modules with an industry standard exterior shape and footprint, responsive to very high speed loads and compatible with ceramic capacitors.

It can be used as design-free POL converters for a 5 V system intermediate bus. It can be configured easily, reducing overall design time, and allowing reuse of designs.

Miniaturization was achieved by high frequency switching technology, allowing saving space on the application PCB.

Soldering capability has been significantly improved by adoption of end face through holes.

Applications:

- Communication devices
- Computer server
- Other low power conversion

Typical Application Circuit

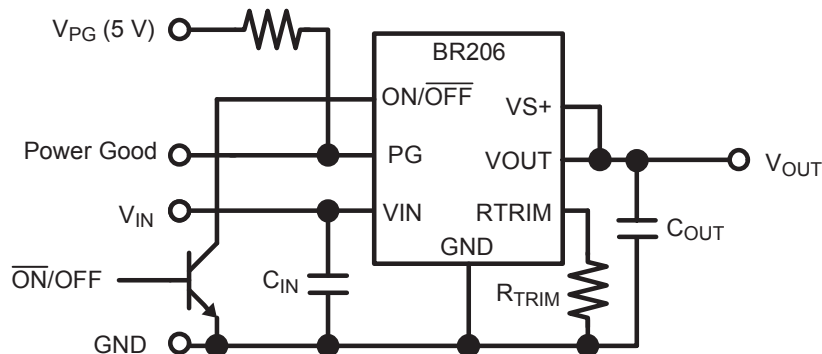

Selection Guide

Part Number	Output Voltage, V_{OUT} (V)	Operating Frequency, f_{OP} (kHz)
BR206	0.75 to 3.63	400

The polarity value for current specifies a sink as "+," and a source as "–," referencing the IC.

Absolute Maximum Ratings, valid at $T_A = 25^\circ\text{C}$

Characteristic	Symbol	Notes	Pins	Rating	Unit
ON/OFF Pin Voltage	V_{ONOFF}		1	7	V
PG Pin Voltage	V_{PG}	Sink current 7 mA	9	7	V
Operating Temperature Range	T_A		–	–40 to 85	$^\circ\text{C}$
Storage Temperature Range	T_{stg}		–	–40 to 85	$^\circ\text{C}$
Operating Humidity Range	H_{OP}	No condensation	–	20 to 85	%
Storage Humidity Range	H_{stg}	No condensation	–	10 to 95	%

Electrical Characteristics Unless specifically noted, T_A is 25°C

Characteristic	Symbol	Test Conditions	Min.	Typ.	Max.	Unit
Input Voltage Range	V_{IN}		4.5	5.0	7.0	V
Output Voltage	V_{OUT}	Adjust with R_{TRIM}	0.75	–	3.63	V
Output Current	I_{OUT}	With temperature derating	0	–	20	A
Output Voltage Accuracy	$Err_{V_{OUT}}$	$1.5\text{ V} \geq V_{OUT} \geq 0.75\text{ V}$, $V_{IN} = 4.5\text{ to }5.5\text{ V}$, $I_{OUT} = 0\text{ to }I_{OUT(max)}$, Operating Temperature Range, $R_{TRIM} = 1\%$ accuracy	–2.0	–	2.0	% V_{OUT}
		$3.63\text{ V} \geq V_{OUT} \geq 1.5\text{ V}$, $V_{IN} = 4.5\text{ to }5.5\text{ V}$, $I_{OUT} = 0\text{ to }I_{OUT(max)}$, Operating Temperature Range, $R_{TRIM} = 1\%$ accuracy	–4.0	–	4.0	% V_{OUT}
		$1.5\text{ V} \geq V_{OUT} \geq 0.75\text{ V}$, $V_{IN} = 4.5\text{ to }7\text{ V}$, $I_{OUT} = 0\text{ to }I_{OUT(max)}$, Operating Temperature Range, $R_{TRIM} = 1\%$ accuracy	–3.0	–	3.0	% V_{OUT}
		$3.63\text{ V} \geq V_{OUT} \geq 1.5\text{ V}$, $V_{IN} = 4.5\text{ to }7\text{ V}$, $I_{OUT} = 0\text{ to }I_{OUT(max)}$, Operating Temperature Range, $R_{TRIM} = 1\%$ accuracy	–5.0	–	5.0	% V_{OUT}
Ripple Voltage ¹	V_{rip}	$BW = 20\text{ MHz}$, $V_{OUT} = 1.5\text{ V}$, $I_{OUT} = 0\text{ to }20\text{ A}$, $C_{OUT} = 400\text{ }\mu\text{F}$	–	–	50	mV _{p-p}
Efficiency	η	$V_{IN} = 5\text{ V}$, $I_{OUT} = 20\text{ A}$, $V_{OUT} = 1.2\text{ V}$	–	84.8	–	%
		$V_{IN} = 5\text{ V}$, $I_{OUT} = 20\text{ A}$, $V_{OUT} = 3.3\text{ V}$	–	93.1	–	%
		$V_{IN} = 7\text{ V}$, $I_{OUT} = 20\text{ A}$, $V_{OUT} = 3.3\text{ V}$	–	93.2	–	%
Operating Frequency	f_{OP}		–	400	–	kHz
Overcurrent Protection Threshold	$I_{OUT(OC)}$	Hiccup	–	30	–	A
Input Capacitor ²	C_{IN}	When input voltage is an ideal voltage source	240	–	5000	μF
Output Capacitor ²	C_{OUT}	When input voltage is an ideal voltage source	400	–	4000	μF
Startup Time	t_r	V_{OUT} from 10% to 90% points	–	2	–	ms
Start Delay Time	t_d	With the $\overline{\text{ON/OFF}}$ pin high, measured from the V_{IN} pin switching high, to V_{OUT} reaching 10% of operating level (see figure 1)	–	2	–	ms
$\overline{\text{ON/OFF}}$ Start Delay Time	t_{rod}	With the V_{IN} pin high, measured from the $\overline{\text{ON/OFF}}$ pin switching high, to V_{OUT} reaching 10% of operating level (see figure 2)	–	2	–	ms
Interface Characteristics						
Power Good	P_{WGL}	Lower limit of Power Good	92.5	96.0	98.5	% V_{OUT}
	P_{WGH}	Upper limit of Power Good	108.0	111.0	114.0	% V_{OUT}
$\overline{\text{ON/OFF}}$ Pin High Voltage	V_{IH}	When the $\overline{\text{ON/OFF}}$ pin is set open, the BR206 converter is turned on	1.8	–	–	V
$\overline{\text{ON/OFF}}$ Pin Low Voltage	V_{IL}	When the $\overline{\text{ON/OFF}}$ pin is pulled down to GND, the BR206 converter is turned off	–	–	0.5	V

¹See the Ripple Voltage Measuring Method section.²Place bypass capacitors between the V_{IN} and V_{OUT} terminals and GND (see C_{IN} and C_{OUT} in the Typical Application Circuit diagram). Locate the capacitor as close as possible to the terminal.

Characteristic Definitions

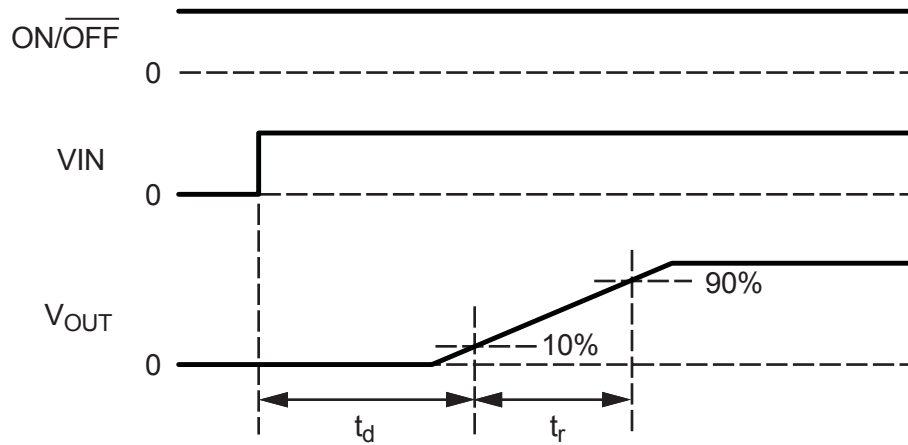
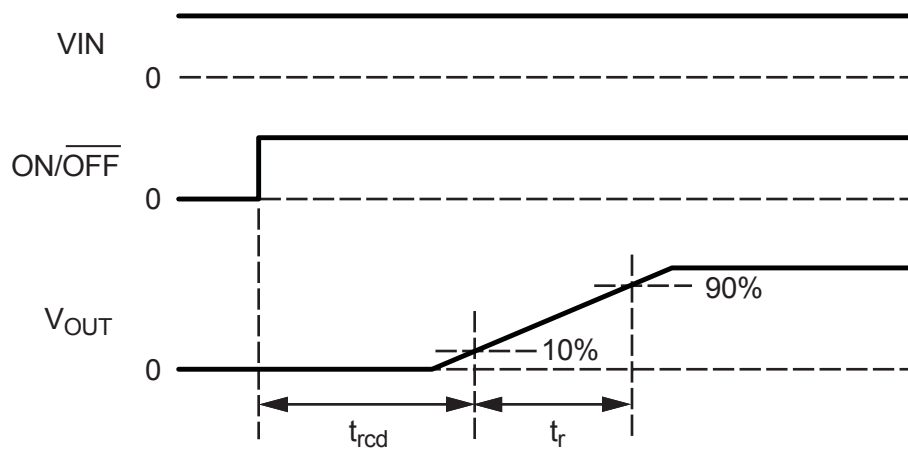
Figure 1. Start Delay Time, t_d , definitionFigure 2. ON/OFF Start Delay Time, t_{rcd} , definition

Performance Characteristics

$T_A = 25^\circ\text{C}$

Efficiency versus Output Current

$V_{OUT} = 1.2\text{ V}$

$V_{OUT} = 3.3\text{ V}$

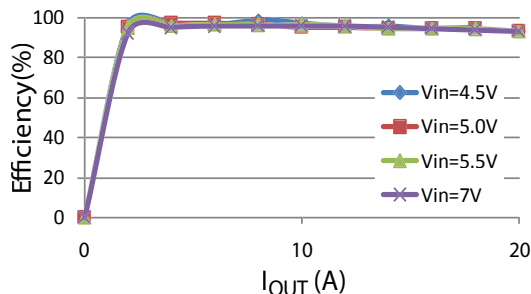
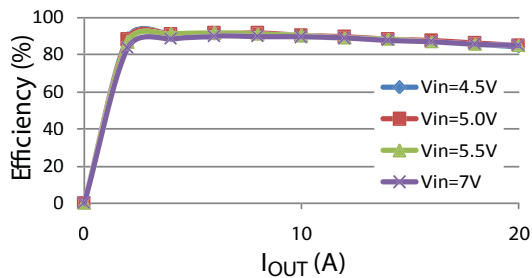

Temperature Derating

Measuring condition:

Product soldered directly to 101.6 × 101.6 mm, 1.6 mm thick, 6-layer PCB
PCB is mounted vertically during measurement

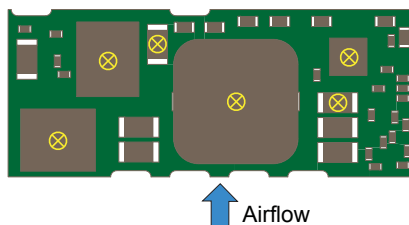

Measuring locations
(Centers of top surface
of major components)

$V_{OUT} = 1.2\text{ V}, V_{IN} = 12.0\text{ V}$
In Still Air

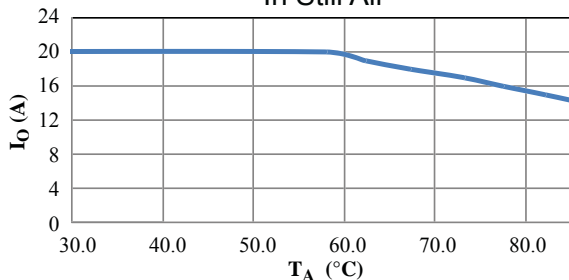

$V_{OUT} = 1.2\text{ V}, V_{IN} = 12.0\text{ V}$
1.5 m/s Airflow

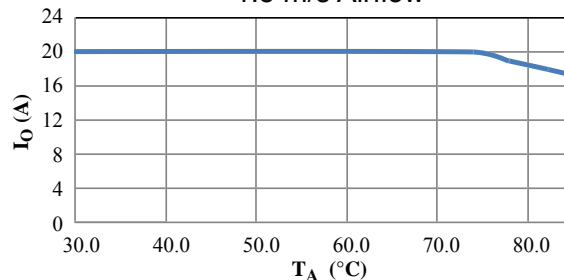

$V_{OUT} = 3.3\text{ V}, V_{IN} = 12.0\text{ V}$
In Still Air

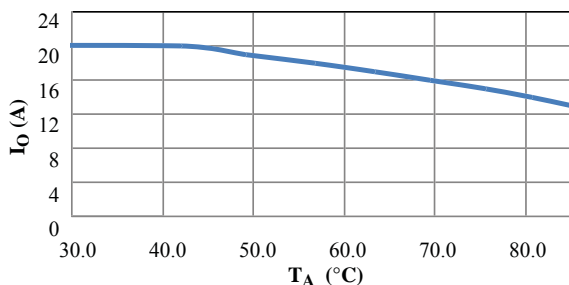

$V_{OUT} = 3.3\text{ V}, V_{IN} = 12.0\text{ V}$
1.5 m/s Airflow

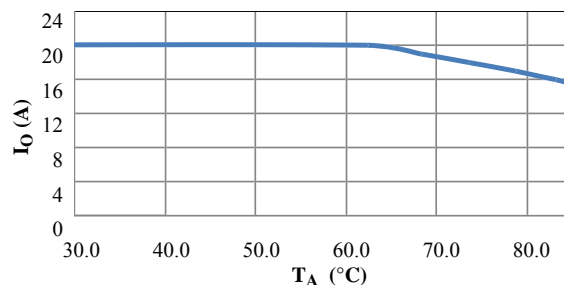

Functional Description

Power Good (PG) Operation

When output voltage, V_{OUT} , is within the Power Good detection range, the PG pin is disconnected internally by the MOSFET switch. The signal at the Power Good node is pulled up to 5 V. If V_{OUT} falls out of the Power Good detection range, the MOSFET switch connects PG to GND, and the signal at the Power Good node is pulled low. The PG peripheral circuit is shown in figure 3.

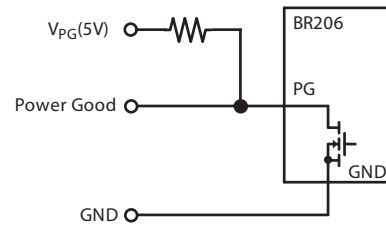

Figure 3. PG peripheral circuit

Output Sensing (VS+) and Compensation

Reduction in output voltage can be compensated by connecting the output sense terminal, VS+, to the load. When using LC filter, the proper connection is shown in panel A of figure 4. Note: Do not connect the output sense terminal to the output of the LC filter. It may not operate normally.

CAUTION: When the output sense terminal is not used, it must be connected directly to the VOUT output terminal. This is shown in panel B of figure 4.

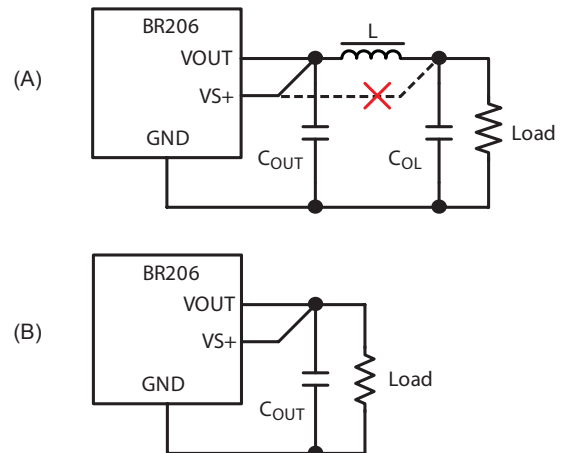

Figure 4. VS+ peripheral circuit

External On/Off Output Control (ON/OFF)

Operation of the output of the product can be turned on and off by using the On/Off function, irrespective of input voltage connection.

This is enabled by connection of the $\overline{\text{ON/OFF}}$ pin (pin 1) (refer to figure 5):

- When the $\overline{\text{ON/OFF}}$ pin is open, the output voltage is on
- When the $\overline{\text{ON/OFF}}$ pin is connected to GND, the output voltage is off

CAUTION:

- The $\overline{\text{ON/OFF}}$ pin is pulled up to V_{IN} via a resistor and is connected to GND via a resistor inside the BR206 converter.
- The $\overline{\text{ON/OFF}}$ pin voltage is set to around 40% of V_{IN} . Do not feed voltage higher than 7 V to the pin from outside the BR206 converter.
- When the $\overline{\text{ON/OFF}}$ pin voltage is higher than 5.5 V, connect a 1 k Ω resistor to the $\overline{\text{ON/OFF}}$ pin in series.

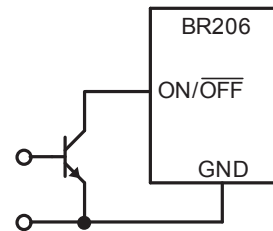

Figure 5. $\overline{\text{ON/OFF}}$ peripheral circuit

R_{TRIM} Constant Reference Value for Output Voltage

The output voltage level is set by the value of a resistance connected to the RTRIM pin.

The following table provides representative values for R_{TRIM} to generate voltages within the specified V_{OUT} ranges:

V _{OUT} (V)	R _{TRIM} (Ω)
3.63	9437
3.3	10593
1.5	31947
1.2	48109
0.75	199503

Reset Conditions

There are two methods for resetting all functions in the BR206 (refer to figure 6):

- Set VIN pin voltage to 1.0 V or lower for a minimum of 100 ms, or
- Set the ON/ $\overline{\text{OFF}}$ pin voltage to 0.5 V or lower for a minimum of 10 ms

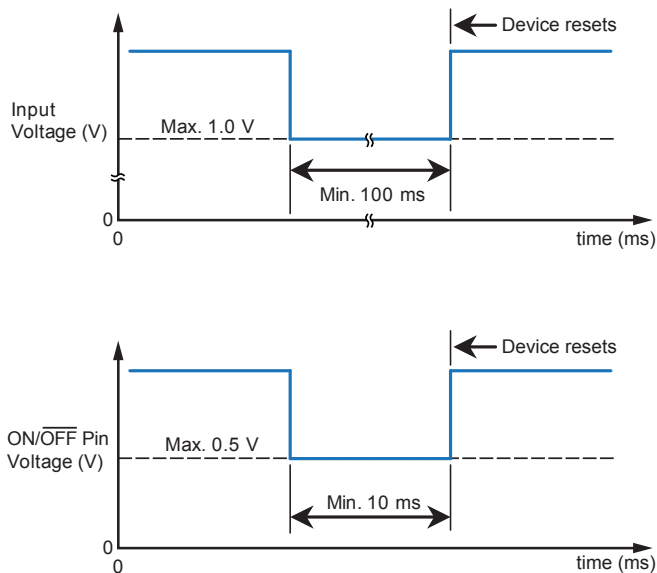
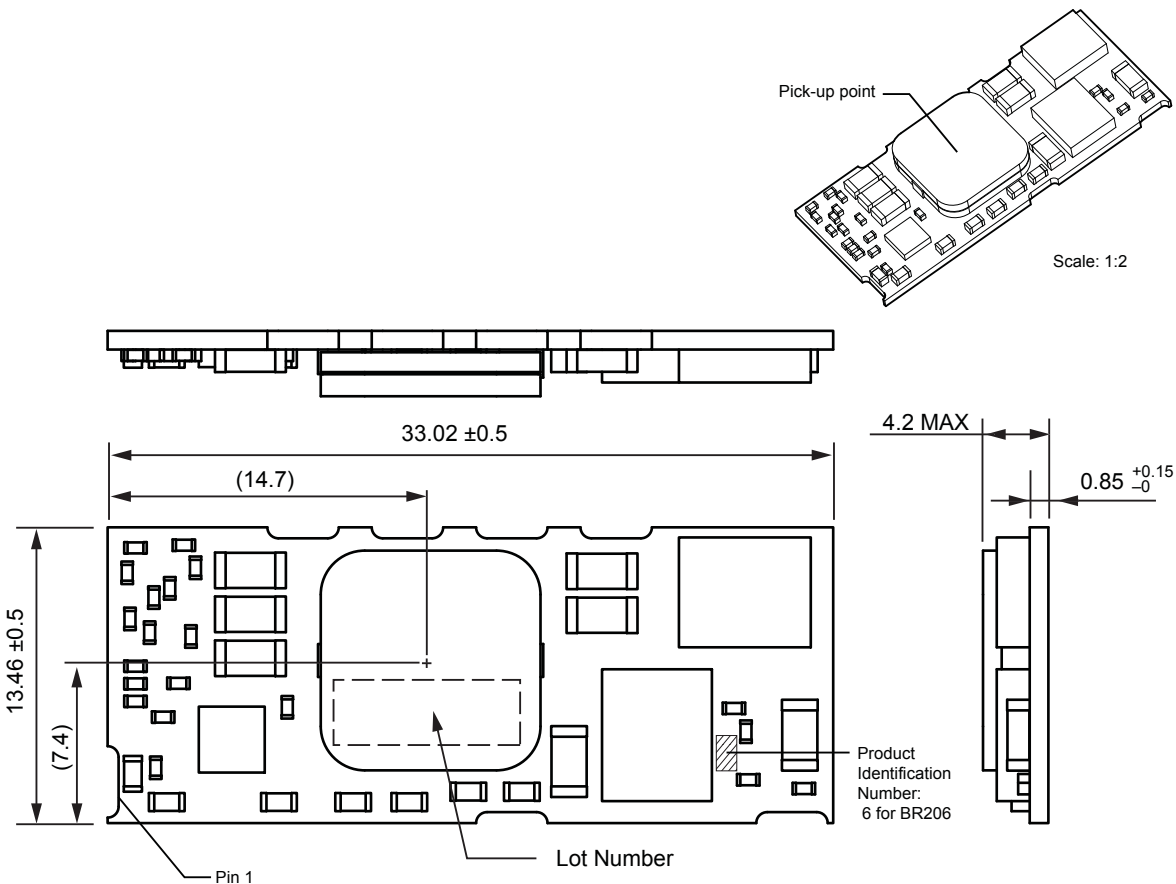

Figure 6. Reset conditions timing diagrams

Package Outline Drawing



- All dimensions are in millimeters
- Dimensions shown in parentheses are reference dimensions.
- Product Weight 3.5 g
- Product Outline 33.0 x 13.5 x 4.2 mm (W x D x H) tolerance includes burrs and protrusions remaining from splitting the printed circuit board
- Coplanarity 0.1 mm (max)



Pb-free, compliant with the RoHS Directive.

RoHS Directive Compliance:

Lead, cadmium, mercury, hexavalent chromium and PBB, PBDE meet the specified criteria on the basis of EU Directive 2002/95/EC, except for nonrestricted materials.

PCB Board Layout and Pin-out Diagram

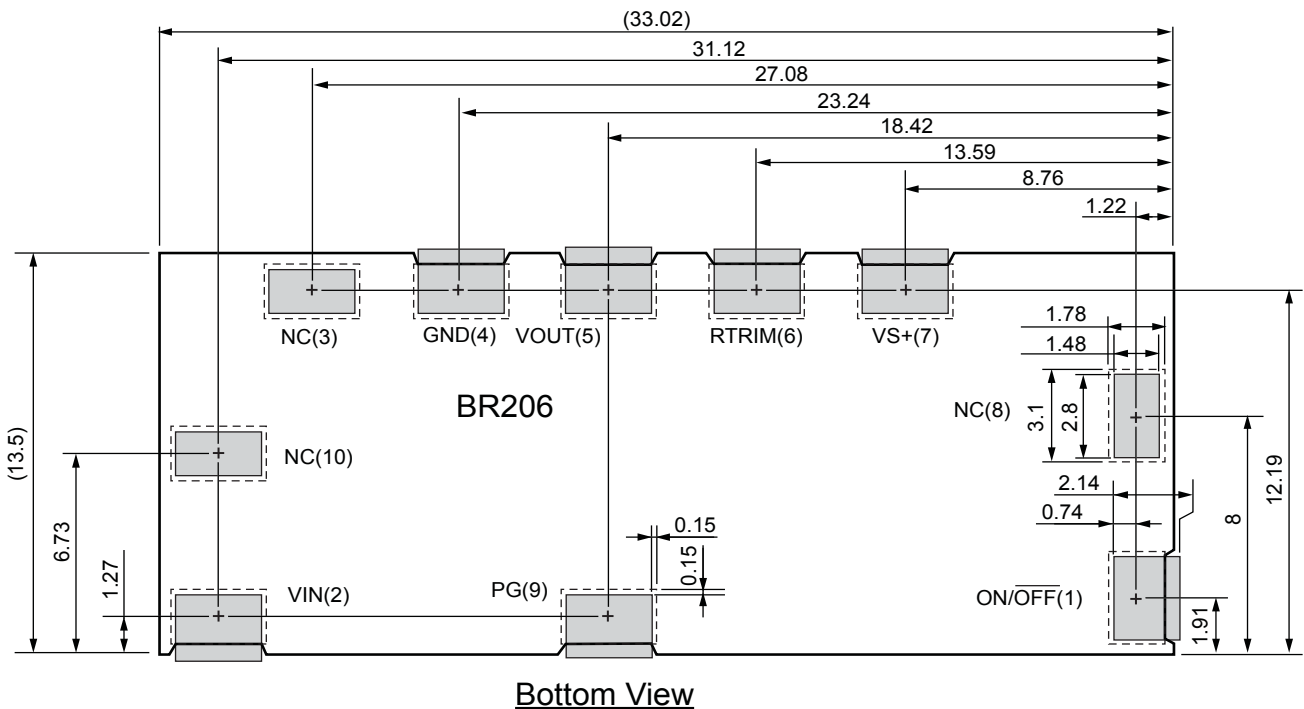

- The tolerance for all dimensions shown is ± 0.1 mm.
- There are lands of the module, pattern, and through holes. Please give consideration to providing sufficient creepage distance when designing the pattern (the traces of different potentials are placed for a creepage distance of 0.25 mm from the land boundaries indicated by the dotted lines).
- The shaded areas indicate dimensions of lands (copper foil dimensions) on the PCB. (1.48 mm x 2.8 mm are the dimensions of a land/footprint.) Dimensions of a footprint do not include tolerance. Dimensions include only an assumed mounting variance of 0.15 mm for both vertical and horizontal directions.
- In actual use of a module, please consider actual mounting variances and adjust footprint dimensions.
- A dotted line indicates a pad of a module. The area which exceeds the footprint dimensions of 1.48 mm x 2.8 mm is the extended pad. When a user requires improvement in power dissipation and to maximize soldered area, it is recommended to cover the whole shaded area. But if a user does not require the improvement, please use the module with minimum pad area, 1.48 mm x 2.8 mm.

Pin List Table

Number	Name	Function
1	ON/OFF	Input for external control of output
2	VIN	Supply for device
3, 8, 10	NC	No connection
4	GND	Device ground terminal
5	VOUT	Output voltage terminal
6	RTRIM	Output voltage level setting terminal, connect to external resistor R_{TRIM}
7	VS+	Output feedback sense terminal
9	PG	Power Good flag output

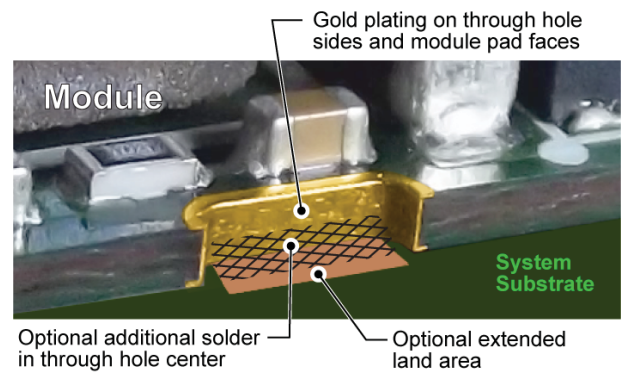

Figure 9. Optional edge soldering at through hole centers

OPERATING PRECAUTIONS

Because reliability can be affected adversely by improper storage environments and handling methods, please observe the following cautions.

Cautions for Storage

- Ensure that storage conditions comply with the standard temperature (5°C to 35°C) and the standard relative humidity (around 40% to 75%); avoid storage locations that experience extreme changes in temperature or humidity.
- Avoid locations where dust or harmful gases are present and avoid direct sunlight.
- Reinspect for rust on leads and solderability of products that have been stored for a long time.

Cautions for Testing and Handling

When tests are carried out during inspection testing and other standard test periods, protect the products from power surges from the testing products, shorts between the product pins, and wrong connections. In addition, avoid tests exceeded ratings.

Electrostatic Discharge

- When handling the products, the operator must be grounded. To prevent shock hazard, grounded wrist straps should be used and at least 1 MΩ of resistance from the operator to ground should be placed near the operator.
- Workbenches where the products are handled should be grounded and be provided with conductive table and floor mats.
- When using measuring equipment such as a curve tracer, the equipment should be grounded.
- When soldering the products, the head of a soldering irons or the solder bath must be grounded in order to prevent leak voltages generated by them from being applied to the products.
- The products should always be stored and transported in Sanken shipping containers or conductive containers, or be wrapped in aluminum foil.

Cautions for Use

- Do not use the power modules under overload conditions as that will damage the module and cause a malfunction or failures.
- Use the products within the specified input voltage range.

-
- The contents in this document are subject to changes, for improvement and other purposes, without notice. Make sure that this is the latest revision of the document before use.
 - Application and operation examples described in this document are quoted for the sole purpose of reference for the use of the products herein and Sanken can assume no responsibility for any infringement of industrial property rights, intellectual property rights or any other rights of Sanken or any third party which may result from its use.
 - Although Sanken undertakes to enhance the quality and reliability of its products, the occurrence of failure and defect of semiconductor products at a certain rate is inevitable. Users of Sanken products are requested to take, at their own risk, preventative measures including safety design of the equipment or systems against any possible injury, death, fires or damages to the society due to device failure or malfunction.
 - Sanken products listed in this document are designed and intended for the use as components in general purpose electronic equipment or apparatus (home appliances, office equipment, telecommunication equipment, measuring equipment, etc.).

When considering the use of Sanken products in the applications where higher reliability is required (transportation equipment and its control systems, traffic signal control systems or equipment, fire/crime alarm systems, various safety devices, etc.), and whenever long life expectancy is required even in general purpose electronic equipment or apparatus, please contact your nearest Sanken sales representative to discuss, prior to the use of the products herein.

The use of Sanken products without the written consent of Sanken in the applications where extremely high reliability is required (aerospace equipment, nuclear power control systems, life support systems, etc.) is strictly prohibited.

- In the case that you use Sanken products or design your products by using Sanken products, the reliability largely depends on the degree of derating to be made to the rated values. Derating may be interpreted as a case that an operation range is set by derating the load from each rated value or surge voltage or noise is considered for derating in order to assure or improve the reliability. In general, derating factors include electric stresses such as electric voltage, electric current, electric power etc., environmental stresses such as ambient temperature, humidity etc. and thermal stress caused due to self-heating of semiconductor products. For these stresses, instantaneous values, maximum values and minimum values must be taken into consideration.

In addition, it should be noted that since power devices or IC's including power devices have large self-heating value, the degree of derating of junction temperature affects the reliability significantly.

- When using the products specified herein by either (i) combining other products or materials therewith or (ii) physically, chemically or otherwise processing or treating the products, please duly consider all possible risks that may result from all such uses in advance and proceed therewith at your own responsibility.
- Anti radioactive ray design is not considered for the products listed herein.
- Sanken assumes no responsibility for any troubles, such as dropping products caused during transportation out of Sanken's distribution network.
- The contents in this document must not be transcribed or copied without Sanken's written consent.