

描述 / Descriptions

TO-220 塑封封装 N 沟道 MOS 场效应管。N-CHANNEL MOSFET in a TO-220 Plastic Package.

特征 / Features

低栅电荷,低反馈电容,开关速度快。
Low gate charge, low crss, fast switching.

用途 / Applications

用于高功率 DC/DC 转换和功率开关。
These devices are well suited for high efficiency switching DC/DC converters and switch mode power supplies.

内部等效电路 / Equivalent Circuit

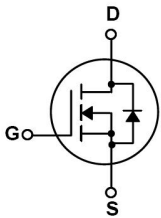

引脚排列 / Pinning

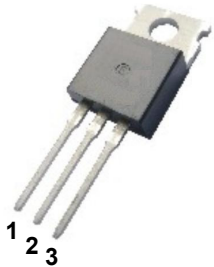

PIN 1 : G PIN 2 : D PIN 3 : S

放大及印章代码 / h_{FE} Classifications & Marking

见印章说明。 See Marking Instructions.

极限参数 / Absolute Maximum Ratings(Ta=25°C)

参数 Parameter	符号 Symbol	数值 Rating	单位 Unit
Drain-Source Voltage	V_{DSS}	75	V
Drain Current	$I_D(T_C=25^\circ C)$	75	A
Drain Current	$I_D(T_C=100^\circ C)$	70	A
Peak Drain Current	I_{DM}	300	A
Gate-Source Voltage	V_{GSS}	± 20	V
Repetitive Avalanche Energy	E_{AS}	480	mJ
Repetitive Avalanche Energy	E_{AR}	13.1	mJ
Avalanche Current	I_{AR}	75	A
Power Dissipation	$P_D(T_C=25^\circ C)$	150	W
Junction and Storage Temperature Range	T_J, T_{STG}	-55 to 150	$^\circ C$

电性能参数 / Electrical Characteristics(Ta=25°C)

参数 Parameter	符号 Symbol	测试条件 Test Conditions	最小值 Min	典型值 Typ	最大值 Max	单位 Unit
Drain-Source Breakdown Voltage	BV_{DSS}	$V_{GS}=0V$ $I_D=250\mu A$	75			V
Zero Gate Voltage Drain Current	I_{DSS}	$V_{DS}=75V$ $V_{GS}=0V$			1	μA
		$V_{DS}=75V$ $V_{GS}=0V$ $T_C=125^\circ C$			10	μA
Gate-Body Leakage Current Forward	I_{GSS}	$V_{GS}=\pm 20V$ $V_{DS}=0V$			± 0.1	μA
Gate Threshold Voltage	$V_{GS(th)}$	$V_{DS}=V_{GS}$ $I_D=250\mu A$	2		4	V
Static Drain-Source On-Resistance	$R_{DS(on)}$	$V_{GS}=10V$ $I_D=40A$		7	10	m Ω
Forward Transconductance	g_{FS}	$V_{DS}=5V$ $I_D=30A$		58		S
Forward On Voltage	V_{SD}	$V_{GS}=0V$ $I_S=40A$			1.3	V
Input Capacitance	C_{iss}	$V_{DS}=25V$ $V_{GS}=0V$ $f=1MHz$		3150		pF
Output Capacitance	C_{oss}				300	pF
Reverse Transfer Capacitance	C_{rss}				240	pF
Turn-On Delay Time	$t_{d(on)}$	$V_{DD}=30V$ $I_D=2A$ $R_L=25\Omega$ $R_G=25\Omega$ $V_{GS}=10V$		18.2		ns
Turn-On Rise Time	t_r				15.6	ns
Turn-Off Delay Time	$t_{d(off)}$				70.5	ns
Turn-Off Fall Time	t_f				13.8	ns

电参数曲线图 / Electrical Characteristic Curve

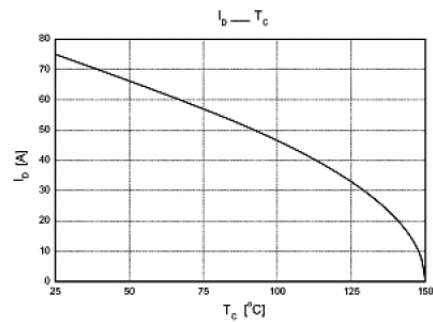
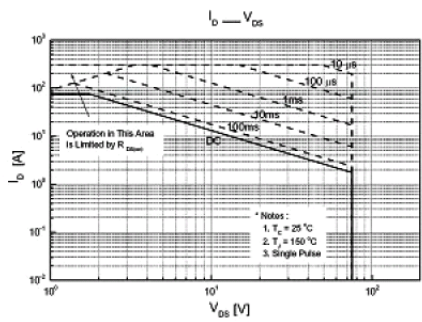
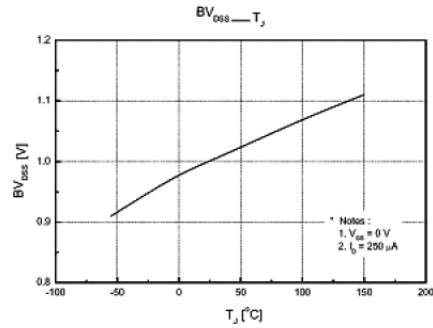
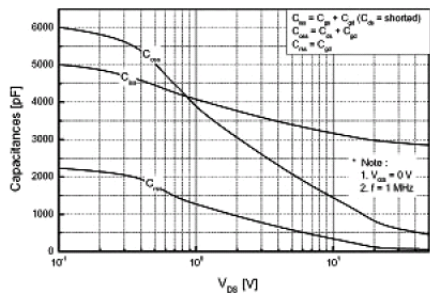
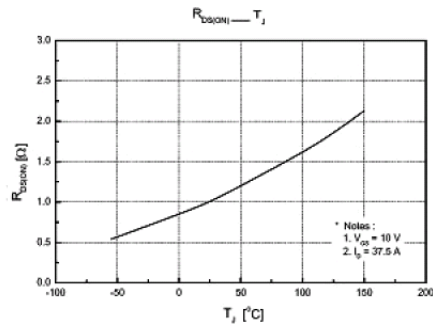
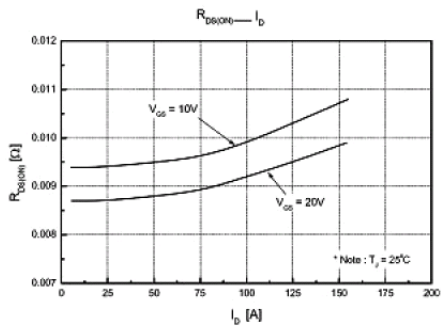
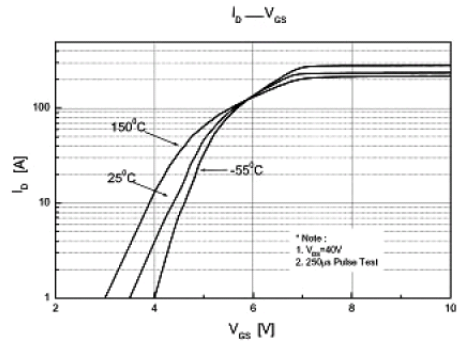
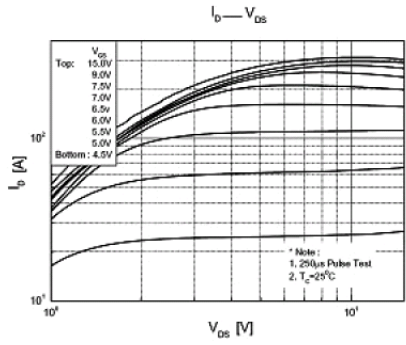

外形尺寸图 / Package Dimensions

TO-220

单位: mm

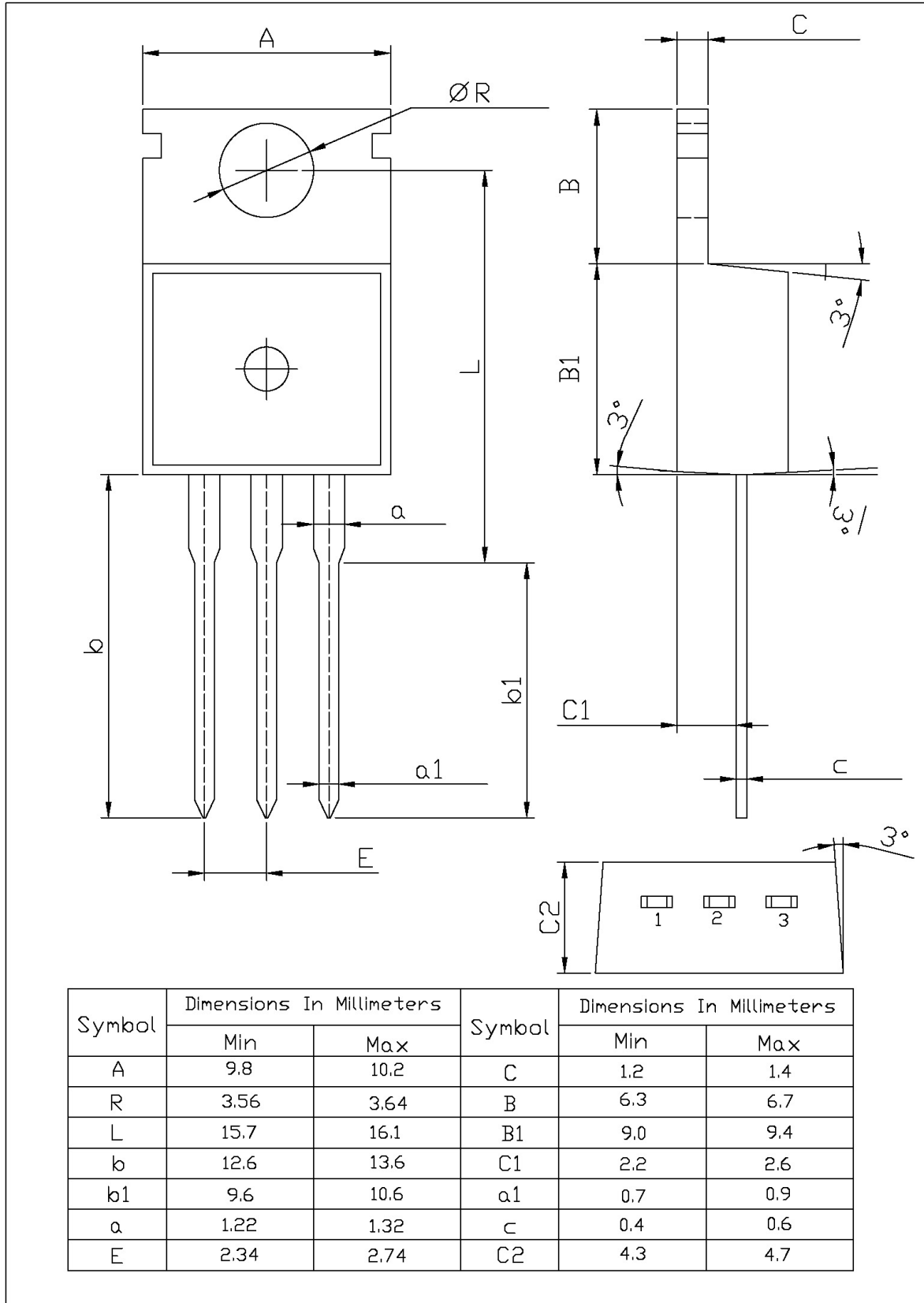

印章说明 / Marking Instructions

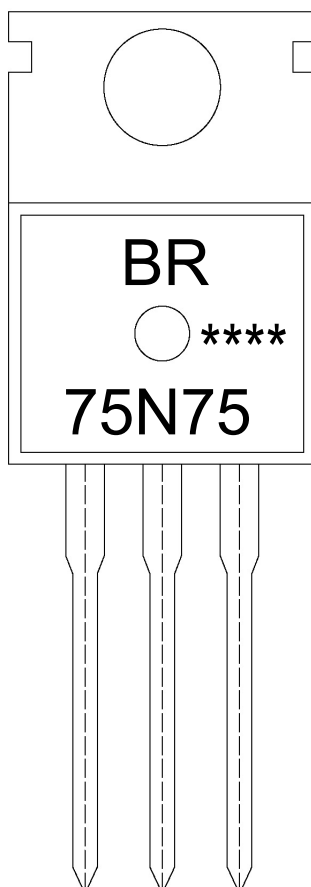

说明：

BR： 为公司代码

75N75： 为型号代码

****： 为生产批号代码，随生产批号变化。

Note:

BR: Company Code

75N75: Product Type.

****: Lot No. Code, code change with Lot No.

波峰焊温度曲线图(无铅) / Temperature Profile for Dip Soldering(Pb-Free)



说明：

- 1、预热温度 25 ~ 150°C，时间 60 ~ 90sec；
- 2、峰值温度 255±5°C，时间持续为 5±0.5sec；
- 3、焊接制程冷却速度为 2 ~ 10°C/sec.

Note:

- 1.Preheating:25~150°C, Time:60~90sec.
- 2.Peak Temp.:255±5°C, Duration:5±0.5sec.
3. Cooling Speed: 2~10°C/sec.

耐焊接热试验条件 / Resistance to Soldering Heat Test Conditions

温度：270±5°C

时间：10±1 sec.

Temp.:270±5°C

Time:10±1 sec

包装规格 / Packaging SPEC.

散件包装 / BULK

Package Type 封装形式	Units 包装数量					Dimension 包装尺寸 (unit: mm ³)		
	Units/Bag 只/袋	Bags/Inner Box 袋/盒	Units/Inner Box 只/盒	Inner Boxes/Outer Box 盒/箱	Units/Outer Box 只/箱	Bag 袋	Inner Box 盒	Outer Box 箱
TO-220/F	200	10	2,000	5	10,000	135×190	237×172×102	560×245×195

套管包装 / TUBE

Package Type 封装形式	Units 包装数量					Dimension 包装尺寸 (unit: mm ³)		
	Units/Tube 只/套管	Tubes/Inner Box 套管/盒	Units/Inner Box 只/盒	Inner Boxes/Outer Box 盒/箱	Units/Outer Box 只/箱	Tube 套管	Inner Box 盒	Outer Box 箱
TO-220/F	50	20	1,000	5	5,000	532×31.4×5.5	555×164×50	575×290×180

使用说明 / Notices