

# BRC144ECM Series

## NPN Built-in Resistor Transistor CMPAK Series

www.DataSheet4U.com

Inverter, Driver, Switching

# HITACHI

ADE-208-1445B (Z)

Rev.2  
Sep. 2001

### Features

- Built-in Resistor Type
- Simplifies Circuit Design
- Reduces Board Space
- Complementary pair with BRA144ECM series

### Outline

CMPAK

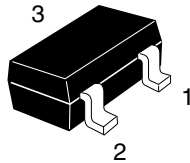

1. Ground (Emitter)
2. Input (Base)
3. Output (Collector)

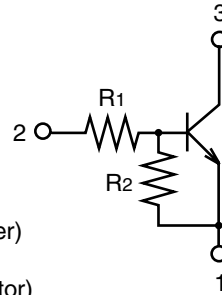

Note: Marking is shown in below.

Device	Marking	R1 (k $\Omega$ )	R2 (k $\Omega$ )
BRC144ECM	BG	47	47
BRC124ECM	DG	22	22
BRC114ECM	FG	10	10
BRC143ECM	HG	4.7	4.7
BRC123ECM	KG	2.2	2.2

## Absolute Maximum Ratings

( $T_a = 25^\circ\text{C}$ )

[www.DataSheet4U.com](http://www.DataSheet4U.com)

Item		Symbol	Ratings	Unit
Supply voltage		$V_{CC}$	50	V
Input voltage	BRC144ECM	$V_I$	-10 to +50	V
	BRC124ECM		-10 to +45	
	BRC114ECM		-10 to +30	
	BRC143ECM		-10 to +20	
	BRC123ECM		-10 to +15	
Output current		$I_o$	100	mA
Total power dissipation		$P_T^*$	150	mW
Junction temperature		$T_j$	150	$^\circ\text{C}$
Storage temperature		$T_{stg}$	-55 to +150	$^\circ\text{C}$

\*Value on the glass epoxy board. (10 mm × 10 mm × 0.7 mm)

## Electrical Characteristics

(Ta = 25°C)

www.DataSheet4U.com

Item	Symbol	Min	Typ	Max	Unit	Test conditions	
Input on voltage	BRC144ECM	$V_{I(on)}$	1.5	—	4.5	V	$V_{cc} = 0.3 \text{ V}, I_o = 5 \text{ mA}$
	BRC124ECM		1.3	—	3.0		
	BRC114ECM		1.2	—	2.4		
	BRC143ECM		1.1	—	2.0		
	BRC123ECM		1.1	—	1.8		
Input off voltage	BRC144ECM	$V_{I(off)}$	1.0	—	1.5	V	$V_{cc} = 5 \text{ V}, I_o = 100 \mu\text{A}$
	BRC124ECM		1.0	—	1.5		
	BRC114ECM		1.0	—	1.5		
	BRC143ECM		1.0	—	1.5		
	BRC123ECM		1.0	—	1.5		
Output saturation voltage	$V_{O(on)}$	—	—	0.3	V	$I_o = 10 \text{ mA}, I_1 = 0.5 \text{ mA}$	
Output cutoff current	$I_{O(off)}$	—	—	0.5	$\mu\text{A}$	$V_{cc} = 50 \text{ V}, I_1 = 0$	
DC current transfer ratio	BRC144ECM	$G_i$	70	—	—		$V_{cc} = 5 \text{ V}, I_o = 5 \text{ mA}$
	BRC124ECM		56	—	—		
	BRC114ECM		30	—	—		
	BRC143ECM		20	—	—	$V_{cc} = 5 \text{ V}, I_o = 10 \text{ mA}$	
	BRC123ECM		20	—	—	$V_{cc} = 5 \text{ V}, I_o = 20 \text{ mA}$	
Input resistance	BRC144ECM	$R_i$	33	47	61	$\text{k}\Omega$	
	BRC124ECM		15	22	28		
	BRC114ECM		7	10	13		
	BRC143ECM		3.3	4.7	6.1		
	BRC123ECM		1.5	2.2	2.8		
Resistance ratio	$R_1/R_2$	0.8	1.0	1.2			

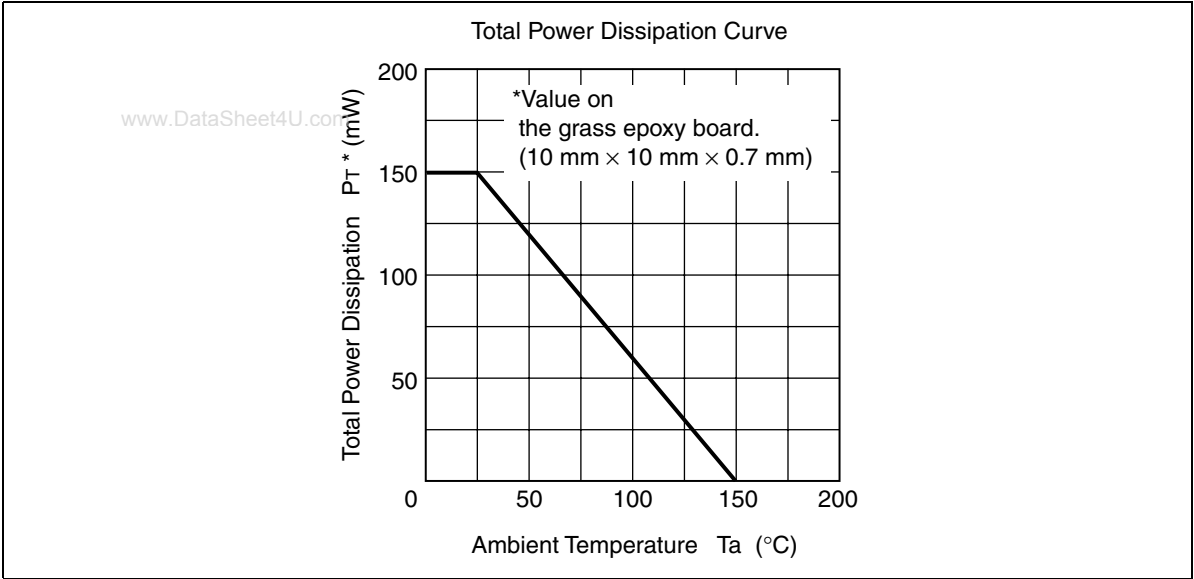

Main Characteristics (BRC144ECM)

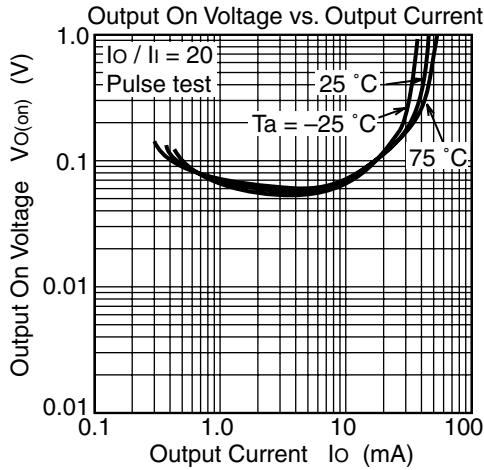
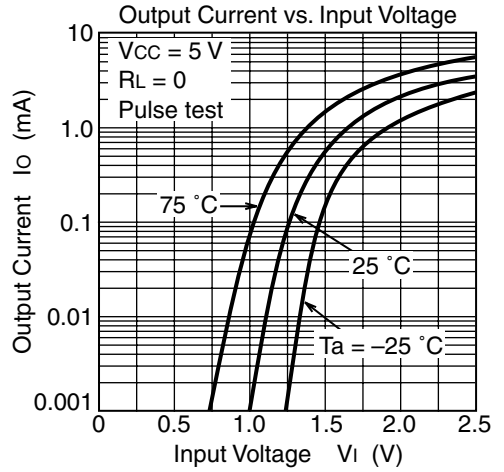
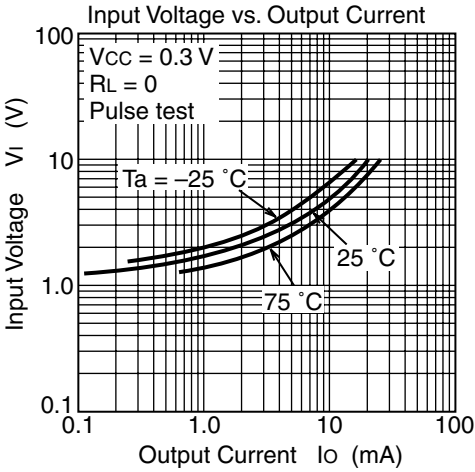
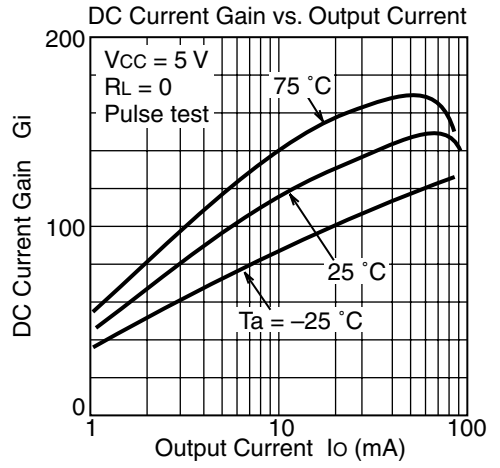
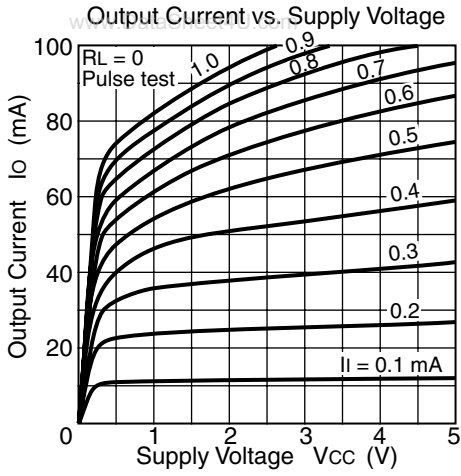

## Main Characteristics (BRC124ECM)

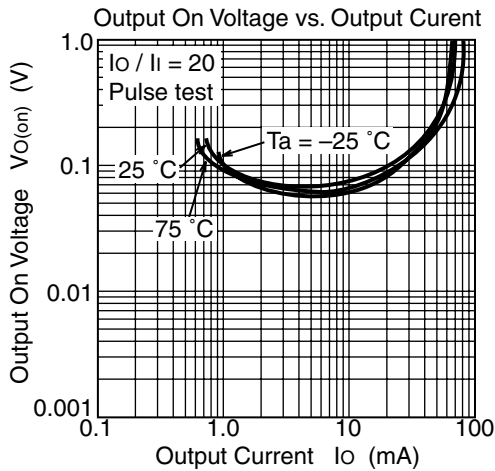
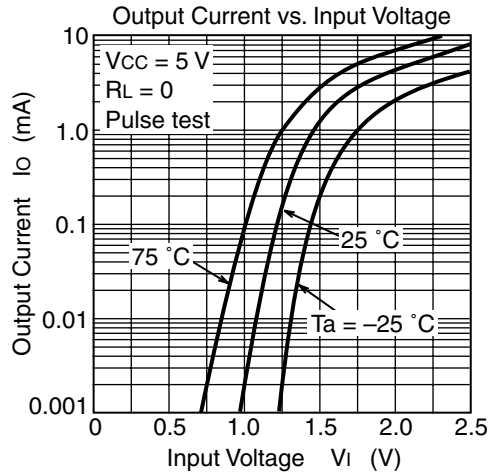
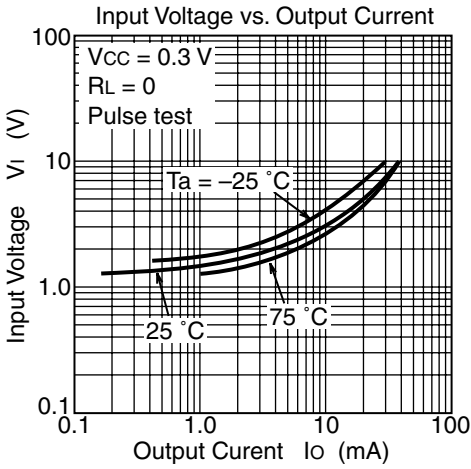
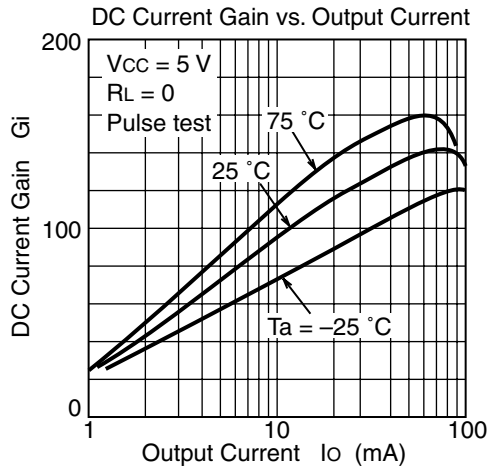
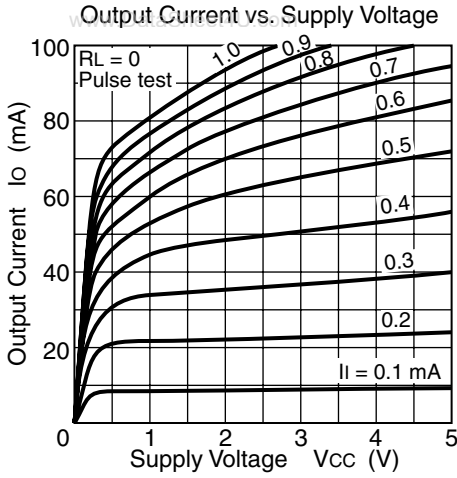

Main Characteristics (BRC114ECM)

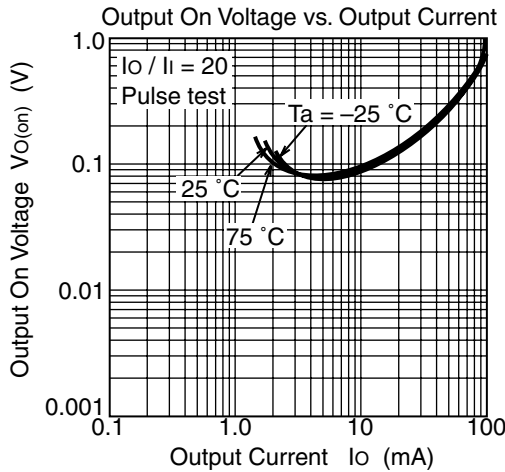
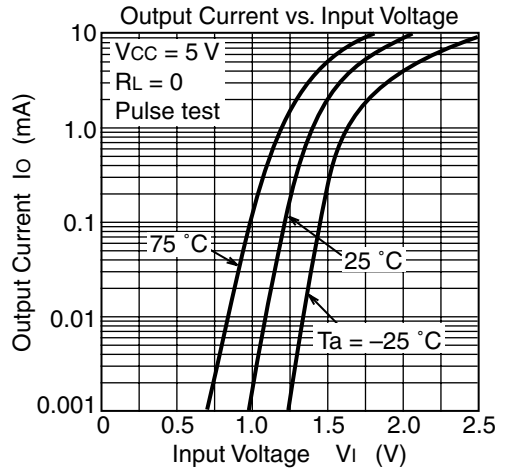
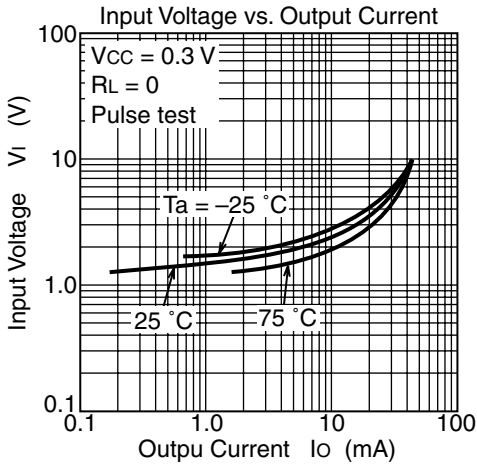
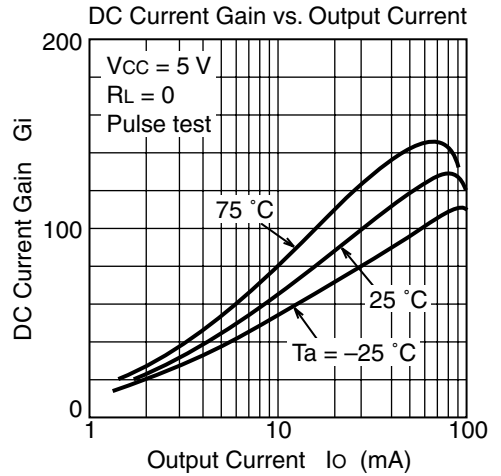
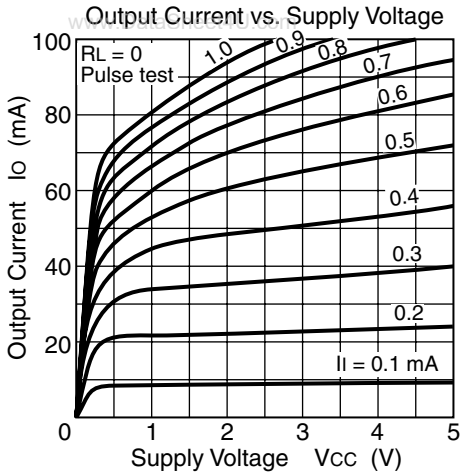

## Main Characteristics (BRC143ECM)

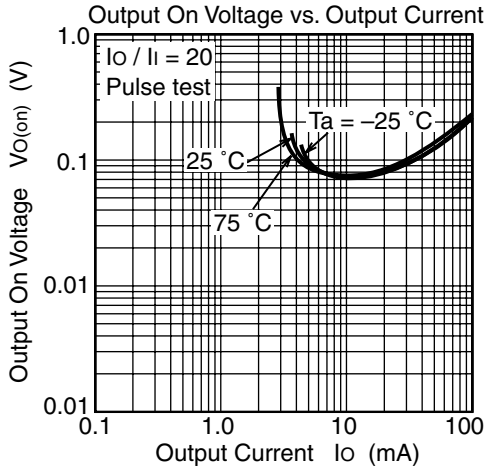
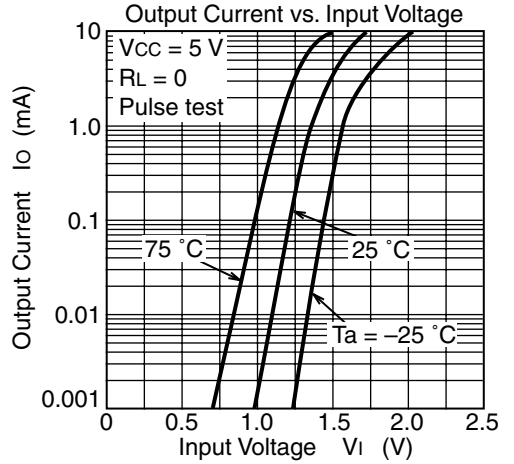
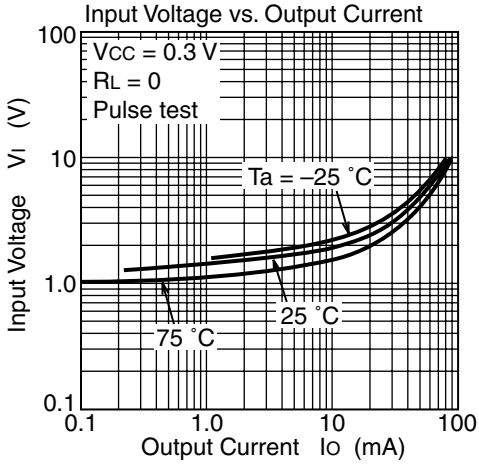
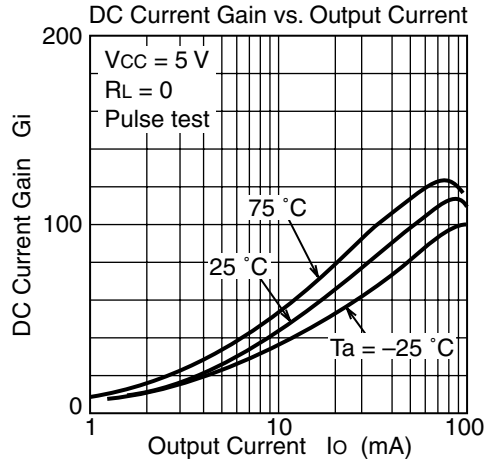
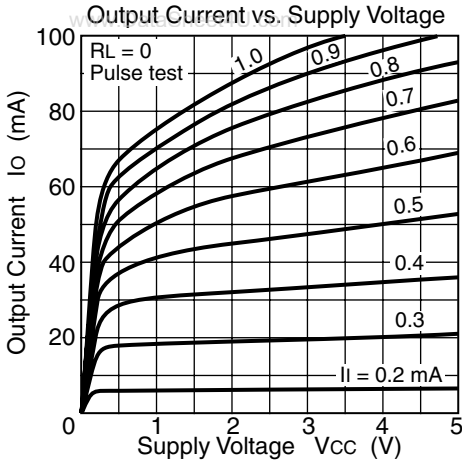



Main Characteristics (BRC123ECM)

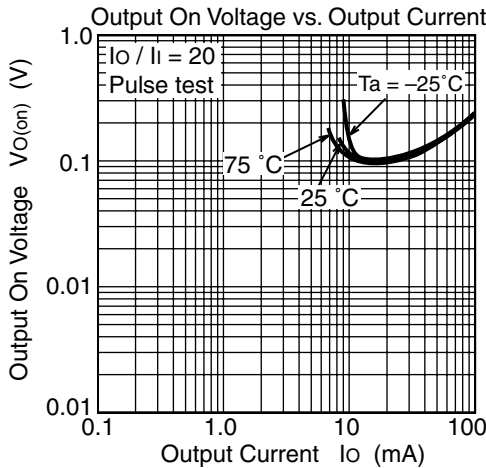
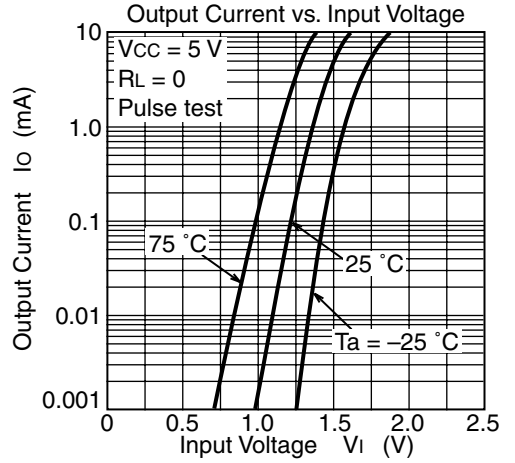
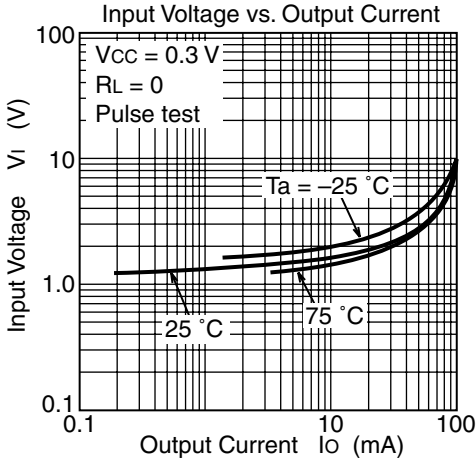
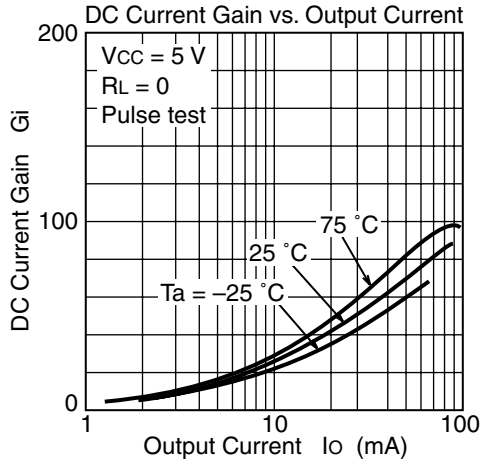
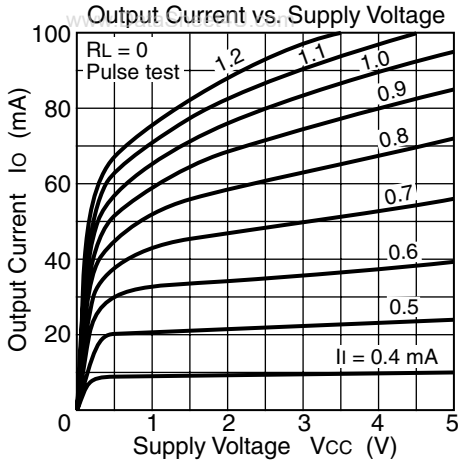

## Taping Specification

There are two different size reels in CMPAK packaging.

[www.DataSheet4U.com](http://www.DataSheet4U.com)

Packing to "Left" direction

Purchasing Identification Code

Standard Reel 3000 pcs/reel: Type No. + Mark **TL**

Large Reel 12000 pcs/reel: Type No. + Mark **UL**

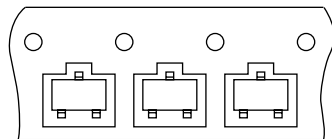

Marking face is up.  
Center lead goes to left.

Direction of feed



Package Dimensions

www.DataSheet4U.com

As of January, 2001  
Unit: mm

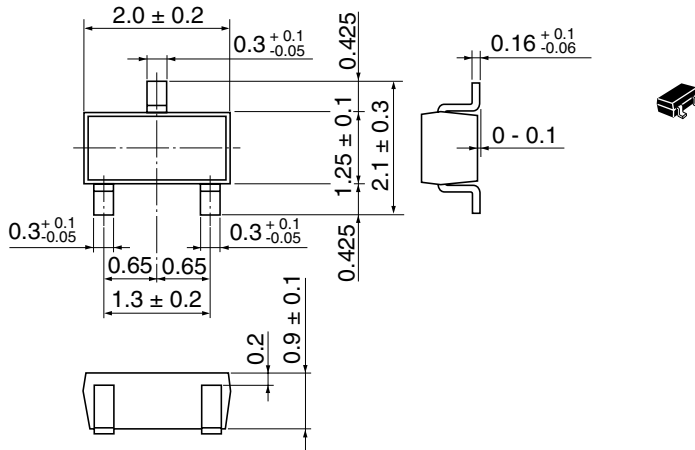

Hitachi Code	CMPAK
JEDEC	—
EIAJ	Conforms
Mass (reference value)	0.006 g

Footprint

CMPAK

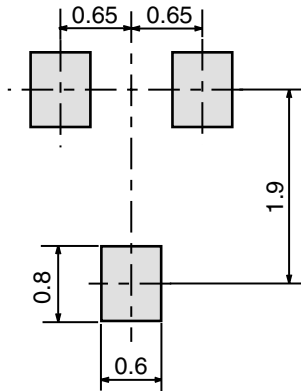

## Disclaimer

1. Hitachi neither warrants nor grants licenses of any rights of Hitachi's or any third party's patent, copyright, trademark, or other intellectual property rights for information contained in this document. Hitachi bears no responsibility for problems that may arise with third party's rights, including intellectual property rights, in connection with use of the information contained in this document.
2. Products and product specifications may be subject to change without notice. Confirm that you have received the latest product standards or specifications before final design, purchase or use.
3. Hitachi makes every attempt to ensure that its products are of high quality and reliability. However, contact Hitachi's sales office before using the product in an application that demands especially high quality and reliability or where its failure or malfunction may directly threaten human life or cause risk of bodily injury, such as aerospace, aeronautics, nuclear power, combustion control, transportation, traffic, safety equipment or medical equipment for life support.
4. Design your application so that the product is used within the ranges guaranteed by Hitachi particularly for maximum rating, operating supply voltage range, heat radiation characteristics, installation conditions and other characteristics. Hitachi bears no responsibility for failure or damage when used beyond the guaranteed ranges. Even within the guaranteed ranges, consider normally foreseeable failure rates or failure modes in semiconductor devices and employ systemic measures such as fail-safes, so that the equipment incorporating Hitachi product does not cause bodily injury, fire or other consequential damage due to operation of the Hitachi product.
5. This product is not designed to be radiation resistant.
6. No one is permitted to reproduce or duplicate, in any form, the whole or part of this document without written approval from Hitachi.
7. Contact Hitachi's sales office for any questions regarding this document or Hitachi semiconductor products.

## Sales Offices

# HITACHI

### Hitachi, Ltd.

Semiconductor & Integrated Circuits  
Nippon Bldg., 2-6-2, Ohte-machi, Chiyoda-ku, Tokyo 100-0004, Japan  
Tel: (03) 3270-2111 Fax: (03) 3270-5109

URL <http://www.hitachisemiconductor.com/>

### For further information write to:

Hitachi Semiconductor  
(America) Inc.  
179 East Tasman Drive  
San Jose, CA 95134  
Tel: <1> (408) 433-1990  
Fax: <1>(408) 433-0223

Hitachi Europe Ltd.  
Electronic Components Group  
Whitebrook Park  
Lower Cookham Road  
Maidenhead  
Berkshire SL6 8YA, United Kingdom  
Tel: <44> (1628) 585000  
Fax: <44> (1628) 585200

Hitachi Europe GmbH  
Electronic Components Group  
Dornacher Straße 3  
D-85622 Feldkirchen  
Postfach 201, D-85619 Feldkirchen  
Germany  
Tel: <49> (89) 9 9180-0  
Fax: <49> (89) 9 29 30 00

Hitachi Asia Ltd.  
Hitachi Tower  
16 Collyer Quay #20-00  
Singapore 049318  
Tel: <65>-538-6533/538-8577  
Fax: <65>-538-6933/538-3877  
URL: <http://semiconductor.hitachi.com.sg>

Hitachi Asia Ltd.  
(Taipei Branch Office)  
4/F, No. 167, Tun Hwa North Road  
Hung-Kuo Building  
Taipei (105), Taiwan  
Tel: <886>-(2)-2718-3666  
Fax: <886>-(2)-2718-8180  
Telex: 23222 HAS-TP  
URL: <http://www.hitachi.com.tw>

Hitachi Asia (Hong Kong) Ltd.  
Group III (Electronic Components)  
7/F., North Tower  
World Finance Centre,  
Harbour City, Canton Road  
Tsim Sha Tsui, Kowloon Hong Kong  
Tel: <852>-(2)-735-9218  
Fax: <852>-(2)-730-0281  
URL: <http://semiconductor.hitachi.com.hk>

Copyright © Hitachi, Ltd., 2001. All rights reserved. Printed in Japan.  
Colophon 5.0