

# Optocoupler, Phototriac Output, Zero Crossing

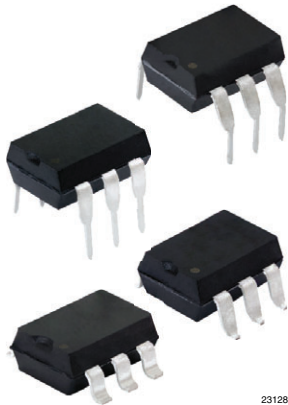

23128

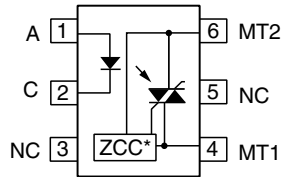

\*Zero crossing circuit



## FEATURES

- Low trigger current  $I_{FT} = 1.2 \text{ mA}$
- $I_{TRMS} = 300 \text{ mA}$
- High static  $dV/dt$   $10\,000 \text{ V}/\mu\text{s}$
- Load voltage =  $800 \text{ V}$
- Zero voltage crossing detector
- Material categorization: for definitions of compliance please see [www.vishay.com/doc?99912](http://www.vishay.com/doc?99912)

**RoHS**  
COMPLIANT

## APPLICATIONS

- Industrial controls
- Office equipment
- Consumer appliances

## AGENCY APPROVALS

- [UL 1577](#)
- [cUL 1577](#)
- [DIN EN 60747-5-5 \(VDE 0884-5\)](#), available with option 1

## LINKS TO ADDITIONAL RESOURCES

**SPICE**  
Models

## DESCRIPTION

The BRT21, BRT22, BRT23 product family consists of an optically coupled GaAs IRLED to a photosensitive thyristor system with integrated noise suppression and zero crossing circuit.

The thyristor system enables low trigger currents of  $1.2 \text{ mA}$  and features a  $dV/dt$  ratio of greater than  $10 \text{ kV}/\mu\text{s}$  and load voltages up to  $800 \text{ V}$ .

The BRT21, BRT22, BRT23 product family is a perfect microcontroller friendly solution to isolate low voltage logic from high voltage  $120 \text{ V}_{AC}$ ,  $240 \text{ V}_{AC}$ , and  $380 \text{ V}_{AC}$  lines and to control resistive, inductive, or capacitive AC loads like motors, solenoids, high power thyristors, or TRIACs and solid-state relays.

## ORDERING INFORMATION

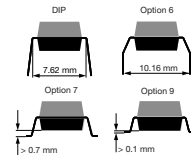
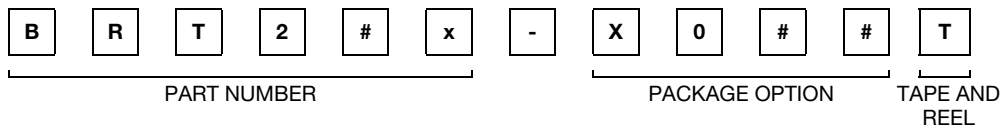

AGENCY CERTIFIED / PACKAGE	$V_{DRM} \text{ (V)}$				
	$\leq 400$	$\leq 600$		$\leq 800$	
<b>UL, cUL</b>	$I_{FT} = 2 \text{ mA}$	$I_{FT} = 1.2 \text{ mA}$	$I_{FT} = 2 \text{ mA}$	$I_{FT} = 1.2 \text{ mA}$	$I_{FT} = 2 \text{ mA}$
DIP-6	BRT21H	BRT22F	BRT22H	BRT23F	BRT23H
DIP-6, 400 mil, option 6	-	-	-	BRT23F-X006	-
SMD-6, option 7	-	BRT22F-X007T	BRT22H-X007T <sup>(1)</sup>	BRT23F-X007T	BRT23H-X007T <sup>(1)</sup>
SMD-6, option 9	-	BRT22F-X009T	-	BRT23F-X009T	-
<b>UL, cUL, VDE (Option 1)</b>	$I_{FT} = 2 \text{ mA}$	$I_{FT} = 1.2 \text{ mA}$	$I_{FT} = 2 \text{ mA}$	$I_{FT} = 1.2 \text{ mA}$	$I_{FT} = 2 \text{ mA}$
DIP-6	-	BRT22F-X001	-	-	BRT23H-X001
DIP-6, option 6	-	-	BRT22H-X016	-	BRT22H-X016

### Note

<sup>(1)</sup> Also available in tube, do not put T on the end



<b>ABSOLUTE MAXIMUM RATINGS</b> ( $T_{amb} = 25\text{ }^{\circ}\text{C}$ , unless otherwise specified)					
PARAMETER	TEST CONDITION	PART	SYMBOL	VALUE	UNIT
<b>INPUT</b>					
Reverse voltage	$I_R = 10\text{ }\mu\text{A}$		$V_R$	6	V
Forward current			$I_F$	60	mA
Surge current			$I_{FSM}$	2.5	A
Power dissipation			$P_{diss}$	100	mW
Derate from 25 °C				1.33	mW/°C
<b>OUTPUT</b>					
Peak off-state voltage		BRT21	$V_{DRM}$	400	V
		BRT22	$V_{DRM}$	600	V
		BRT23	$V_{DRM}$	800	V
On state RMS current			$I_{TRM}$	300	mA
Single cycle surge current				3	A
Power dissipation			$P_{diss}$	600	mW
Derate from 25 °C				6.6	mW/°C
<b>COUPLER</b>					
Storage temperature range			$T_{stg}$	-40 to +150	°C
Ambient temperature range			$T_{amb}$	-40 to +100	°C
Soldering temperature	Max. $\leq 10\text{ s}$ dip soldering $\geq 0.5\text{ mm}$ from case bottom		$T_{sld}$	260	°C

**Note**

- Stresses in excess of the absolute maximum ratings can cause permanent damage to the device. Functional operation of the device is not implied at these or any other conditions in excess of those given in the operational sections of this document. Exposure to absolute maximum ratings for extended periods of the time can adversely affect reliability.



<b>ELECTRICAL CHARACTERISTICS</b> ( $T_{amb} = 25\text{ }^{\circ}\text{C}$ , unless otherwise specified)							
PARAMETER	TEST CONDITION	PART	SYMBOL	MIN.	TYP.	MAX.	UNIT
<b>INPUT</b>							
Forward voltage	$I_F = 10\text{ mA}$		$V_F$	-	1.16	1.35	V
Reverse current	$V_R = 6\text{ V}$		$I_R$	-	0.1	10	$\mu\text{A}$
Capacitance	$f = 1\text{ MHz}, V_F = 0\text{ V}$		$C_O$	-	25	-	pF
Thermal resistance, junction to ambient			$R_{thJA}$	-	750	-	K/W
<b>OUTPUT</b>							
Peak off-state voltage	$I_{D(RMS)} = 100\text{ }\mu\text{A}$	BRT21	$V_{DM}$	-	400	-	V
		BRT22		-	600	-	
		BRT23		-	800	-	
Off-state current	$V_D = V_{DRM}, T_{amb} = 100\text{ }^{\circ}\text{C}, I_F = 0\text{ mA}$		$I_{D(RMS)}$	-	10	100	$\mu\text{A}$
On-state voltage	$I_T = 300\text{ mA}$		$V_{TM}$	-	1.7	3	V
On-state current	$PF = 1, V_{T(RMS)} = 1.7\text{ V}$		$I_{TM}$	-	-	300	mA
Surge (non-repetitive), on-state current	$f = 50\text{ Hz}$		$I_{TSM}$	-	-	3	A
Trigger current temp. gradient			$\Delta I_{FT1}/\Delta T_j$	-	7	14	$\mu\text{A/K}$
			$\Delta I_{FT2}/\Delta T_j$	-	7	14	$\mu\text{A/K}$
Inhibit voltage temp. gradient			$\Delta V_{DINH}/\Delta T_j$	-	-20	-	mV/K
Off-state current in inhibit state	$I_F = I_{FT1}, V_{DRM}$		$I_{DINH}$	-	50	200	$\mu\text{A}$
Holding current			$I_H$	-	65	500	$\mu\text{A}$
Latching current	$V_T = 2.2\text{ V}$		$I_L$	-	5	-	mA
Zero cross inhibit voltage	$I_F = \text{rated } I_{FT}$		$V_{IH}$	-	15	25	V
<b>OUTPUT (continued)</b>							
Turn-on time	$V_{RM} = V_{DM} = V_{D(RMS)}$		$t_{on}$	-	35	-	$\mu\text{s}$
Turn-off time	$PF = 1, I_T = 300\text{ mA}$		$t_{off}$	-	50	-	$\mu\text{s}$
Critical rate of rise of off-state voltage	$V_D = 0.67 V_{DRM}, T_j = 25\text{ }^{\circ}\text{C}$		$dV/dt_{cr}$	10 000	-	-	V/ $\mu\text{s}$
	$V_D = 0.67 V_{DRM}, T_j = 80\text{ }^{\circ}\text{C}$		$dV/dt_{cr}$	5000	-	-	V/ $\mu\text{s}$
Critical rate of rise of voltage at current commutation	$V_D = 230 V_{RMS}, I_D = 300\text{ mA}_{RMS}, T_j = 25\text{ }^{\circ}\text{C}$		$dV/dt_{crq}$	-	8	-	V/ $\mu\text{s}$
	$V_D = 230 V_{RMS}, I_D = 300\text{ mA}_{RMS}, T_j = 85\text{ }^{\circ}\text{C}$		$dV/dt_{crq}$	-	7	-	V/ $\mu\text{s}$
Critical rate of rise of on-state at current commutation	$V_D = 230 V_{RMS}, I_D = 300\text{ mA}_{RMS}, T_j = 25\text{ }^{\circ}\text{C}$		$dI/dt_{crq}$	-	12	-	A/ms
Thermal resistance, junction-to-ambient			$R_{thJA}$	-	125	-	K/W
<b>COUPLER</b>							
Critical rate of rise of coupled input / output voltage	$I_T = 0\text{ A}, V_{RM} = V_{DM} = V_{D(RMS)}$		$dV_{IO}/dt$	-	10 000	-	V/ $\mu\text{s}$
Common mode coupling capacitance			$C_{CM}$	-	0.01	-	pF
Capacitance (input to output)	$f = 1\text{ MHz}, V_{IO} = 0\text{ V}$		$C_{IO}$	-	0.8	-	pF
Trigger current	$V_D = 5\text{ V}, F\text{-versions}$		$I_{FT}$	-	-	1.2	mA
	$V_D = 5\text{ V}, H\text{-versions}$		$I_{FT}$	-	-	2	mA

**Note**

- Minimum and maximum values are testing requirements. Typical values are characteristics of the device and are the result of engineering evaluation. Typical values are for information only and are not part of the testing requirements.

SAFETY AND INSULATION RATINGS				
PARAMETER	TEST CONDITION	SYMBOL	VALUE	UNIT
Climatic classification	According to IEC 68 part 1		40 / 100 / 21	
Pollution degree	According to DIN VDE 0109		2	
Comparative tracking index	Insulation group IIIa	CTI	175	
Maximum rated withstanding isolation voltage	According to UL1577, t = 1 min	V <sub>ISO</sub>	4420	V <sub>RMS</sub>
Tested withstanding isolation voltage	According to UL1577, t = 1 s	V <sub>ISO</sub>	5300	V <sub>RMS</sub>
Maximum transient isolation voltage	According to DIN EN 60747-5-5	V <sub>IOTM</sub>	6000	V <sub>peak</sub>
Maximum repetitive peak isolation voltage	According to DIN EN 60747-5-5	V <sub>IORM</sub>	630	V <sub>peak</sub>
Isolation resistance	V <sub>IO</sub> = 500 V, T <sub>amb</sub> = 25 °C	R <sub>IO</sub>	≥ 10 <sup>12</sup>	Ω
	V <sub>IO</sub> = 500 V, T <sub>amb</sub> = 100 °C	R <sub>IO</sub>	≥ 10 <sup>11</sup>	Ω
Output safety power		P <sub>SO</sub>	200	mW
Input safety current		I <sub>SI</sub>	400	mA
Input safety temperature		T <sub>S</sub>	175	°C
Creepage distance	DIP-6; SMD-6, option 7; SMD-6 option 9		≥ 7	mm
Clearance distance			≥ 7	mm
Creepage distance	DIP-6, option 6; SMD-6, option 8		≥ 8	mm
Clearance distance			≥ 8	mm
Insulation thickness		DTI	≥ 0.4	mm

**Note**

- As per IEC 60747-5-5, § 7.4.3.8.2, this optocoupler is suitable for “safe electrical insulation” only within the safety ratings. Compliance with the safety ratings shall be ensured by means of protective circuits.

**POWER FACTOR CONSIDERATIONS**

A snubber is not needed to eliminate false operation of the TRIAC driver because of the high static and commutating dV/dt with loads between 1.0 and 0.8 power factors. When inductive loads with power factors less than 0.8 are being driven, include a RC snubber or a single capacitor directly across the device to damp the peak commutating dV/dt spike. Normally a commutating dV/dt causes a turning-off device to stay on due to the stored energy remaining in the turning-off device.

But in the case of a zero voltage crossing optotriac, the commutating dV/dt spikes can inhibit one half of the TRIAC from turning on. If the spike potential exceeds the inhibit voltage of the zero cross detection circuit, half of the TRIAC will be held off and not turn-on. This hold-off condition can be eliminated by using a snubber or capacitor placed directly across the optotriac as shown in figure 1. Note that the value of the capacitor increases as a function of the load current.

The hold-off condition also can be eliminated by providing a higher level of LED drive current. The higher LED drive provides a larger photocurrent which causes the phototransistor to turn-on before the commutating spike has activated the zero cross network. Figure 2 shows the relationship of the LED drive for power factors of less than 1.0. The curve shows that if a device requires 1.5 mA for a resistive load, then 1.8 times 2.7 mA that amount would be required to control an inductive load whose power factor is less than 0.3.

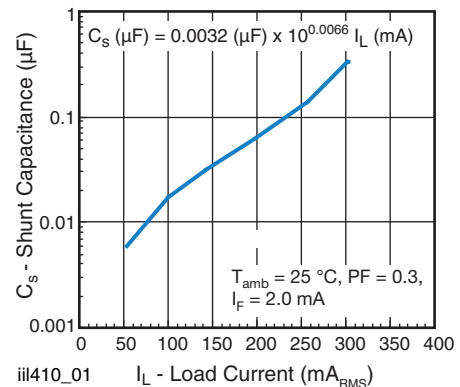

Fig. 1 - Shunt Capacitance vs. Load Current

**TYPICAL CHARACTERISTICS** ( $T_{amb} = 25\text{ }^{\circ}\text{C}$ , unless otherwise specified)

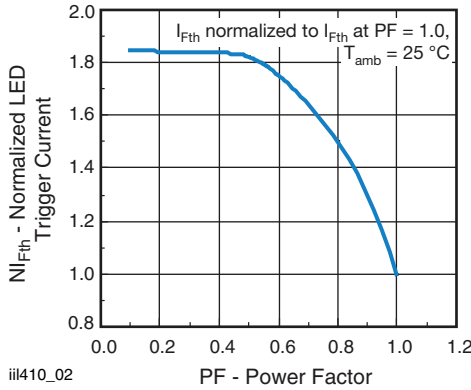

Fig. 2 - Normalized LED Trigger Current vs. Power Factor

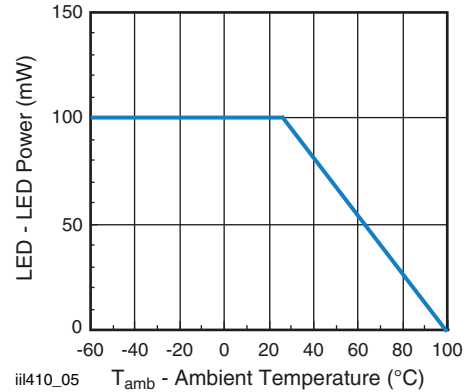

Fig. 5 - Maximum LED Power Dissipation

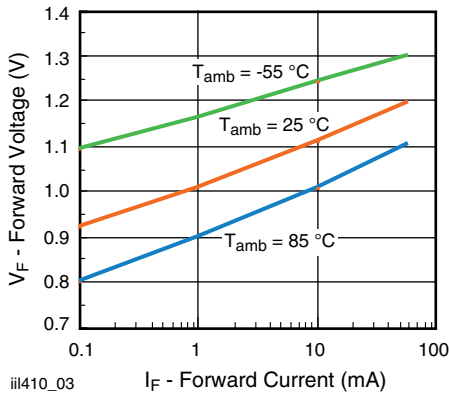

Fig. 3 - Forward Voltage vs. Forward Current

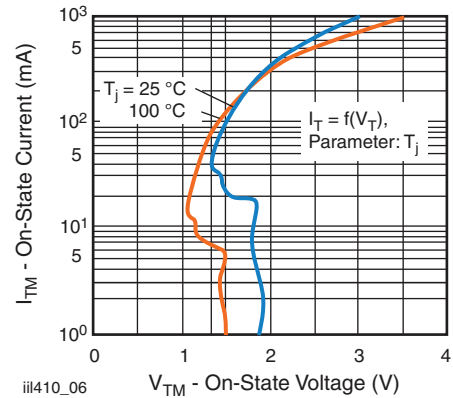

Fig. 6 - Typical Output Characteristics

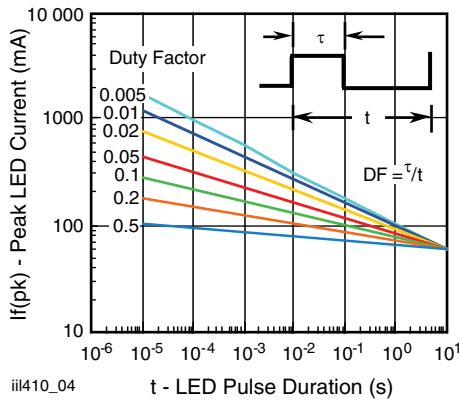

Fig. 4 - Peak LED Current vs. Duty Factor,  $\tau$

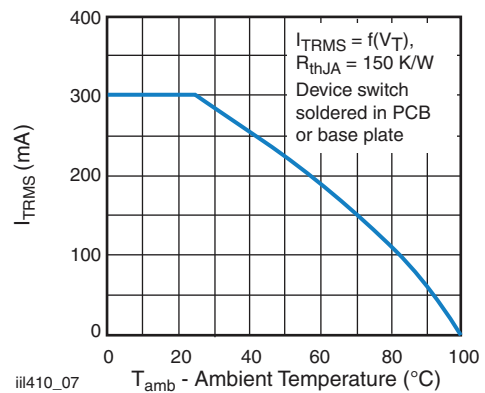

Fig. 7 - Current Reduction

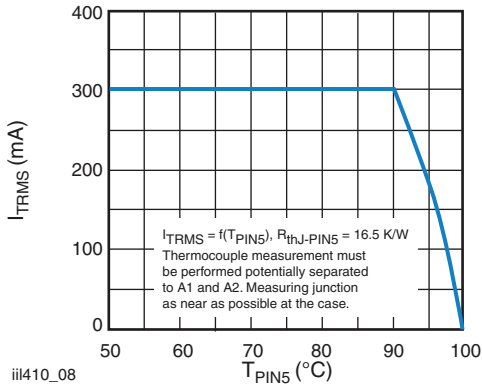

Fig. 8 - Current Reduction

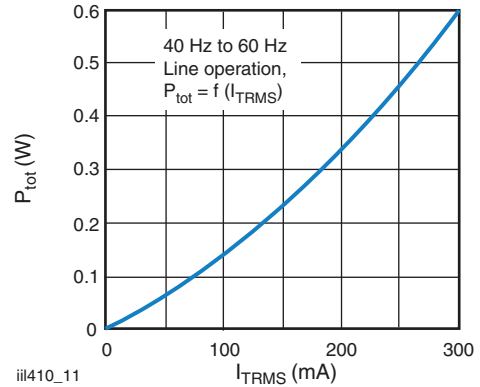

Fig. 11 - Power Dissipation 40 Hz to 60 Hz Line Operation

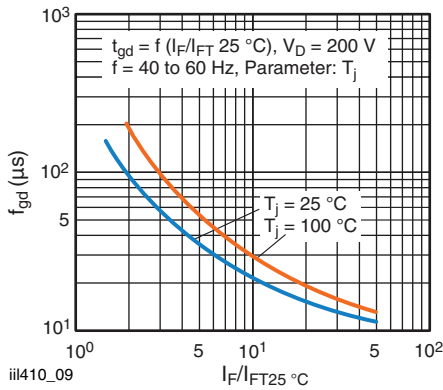

Fig. 9 - Typical Trigger Delay Time

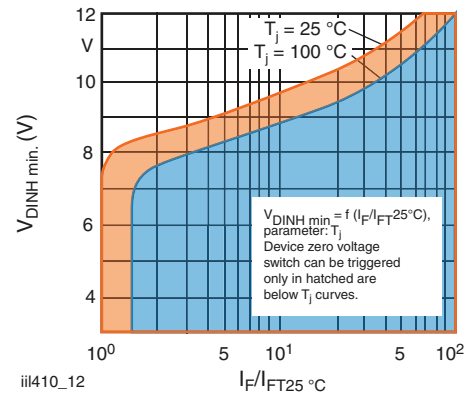

Fig. 12 - Typical Static Inhibit Voltage Limit

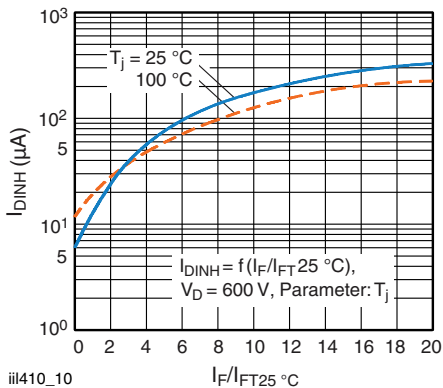

Fig. 10 - Typical Inhibit Current

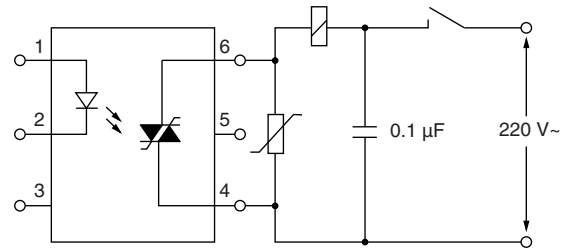
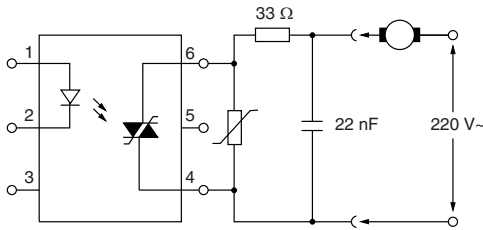
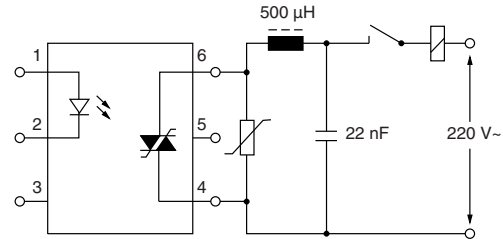

Fig. 13 - Apply a Capacitor to the Supply Pins at the Load-Side



iii410\_14

Fig. 14 - Connect a Series Resistor to the Output and Bridge Both by a Capacitor



iii410\_15

Fig. 15 - Connect a Choke of Low Winding Cap. in Series, e.g., a Ringcore Choke, with Higher Load Currents

## TECHNICAL INFORMATION

See Application Note for additional information.

## PACKAGE DIMENSIONS in millimeters

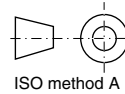
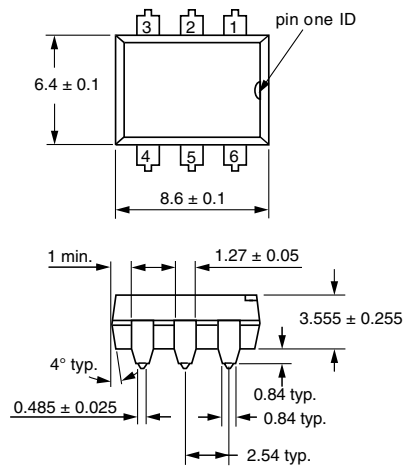

ISO method A

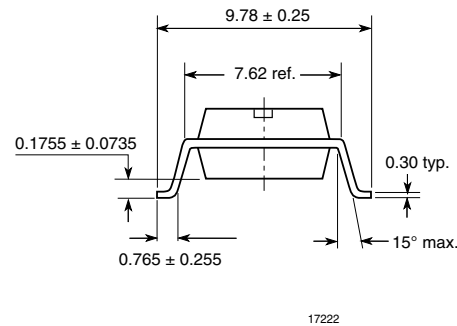

17222

Option 6

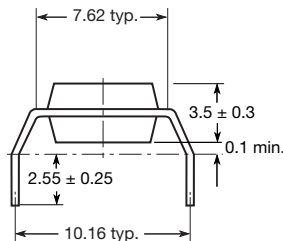

Option 7

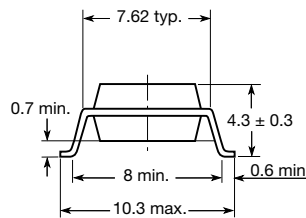

Option 9

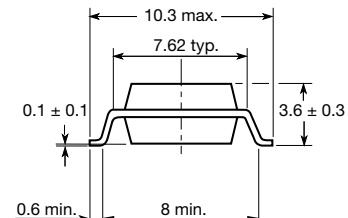

20802-57

## PACKAGE MARKING (example)

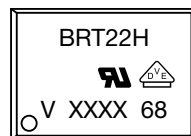
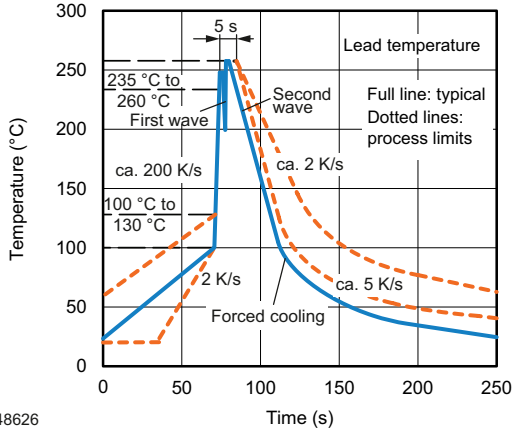

Fig. 16 - Example of BRT22H-X017

## Notes

- XXXX = LMC (lot marking code)
- VDE logo is only marked on option 1 parts
- Tape and reel suffix (T) is not part of the package marking

**SOLDER PROFILES**



948626

Fig. 17 - Wave Soldering Double Wave Profile According to J-STD-020 for DIP Devices

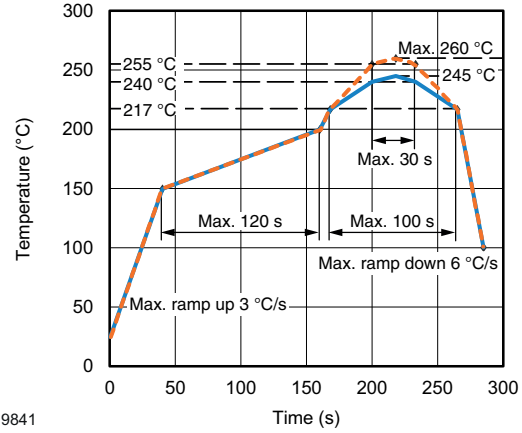

19841

Fig. 18 - Lead (Pb)-free Reflow Solder Profile According to J-STD-020 for SMD Devices

**HANDLING AND STORAGE CONDITIONS**

ESD level: HBM class 2

Floor life: unlimited

Conditions:  $T_{amb} < 30\text{ }^{\circ}\text{C}$ , RH < 85 %

Moisture sensitivity level 1, according to J-STD-020





## Disclaimer

ALL PRODUCT, PRODUCT SPECIFICATIONS AND DATA ARE SUBJECT TO CHANGE WITHOUT NOTICE TO IMPROVE RELIABILITY, FUNCTION OR DESIGN OR OTHERWISE.

Vishay Intertechnology, Inc., its affiliates, agents, and employees, and all persons acting on its or their behalf (collectively, "Vishay"), disclaim any and all liability for any errors, inaccuracies or incompleteness contained in any datasheet or in any other disclosure relating to any product.

Vishay makes no warranty, representation or guarantee regarding the suitability of the products for any particular purpose or the continuing production of any product. To the maximum extent permitted by applicable law, Vishay disclaims (i) any and all liability arising out of the application or use of any product, (ii) any and all liability, including without limitation special, consequential or incidental damages, and (iii) any and all implied warranties, including warranties of fitness for particular purpose, non-infringement and merchantability.

Statements regarding the suitability of products for certain types of applications are based on Vishay's knowledge of typical requirements that are often placed on Vishay products in generic applications. Such statements are not binding statements about the suitability of products for a particular application. It is the customer's responsibility to validate that a particular product with the properties described in the product specification is suitable for use in a particular application. Parameters provided in datasheets and / or specifications may vary in different applications and performance may vary over time. All operating parameters, including typical parameters, must be validated for each customer application by the customer's technical experts. Product specifications do not expand or otherwise modify Vishay's terms and conditions of purchase, including but not limited to the warranty expressed therein.

Hyperlinks included in this datasheet may direct users to third-party websites. These links are provided as a convenience and for informational purposes only. Inclusion of these hyperlinks does not constitute an endorsement or an approval by Vishay of any of the products, services or opinions of the corporation, organization or individual associated with the third-party website. Vishay disclaims any and all liability and bears no responsibility for the accuracy, legality or content of the third-party website or for that of subsequent links.

Except as expressly indicated in writing, Vishay products are not designed for use in medical, life-saving, or life-sustaining applications or for any other application in which the failure of the Vishay product could result in personal injury or death. Customers using or selling Vishay products not expressly indicated for use in such applications do so at their own risk. Please contact authorized Vishay personnel to obtain written terms and conditions regarding products designed for such applications.

No license, express or implied, by estoppel or otherwise, to any intellectual property rights is granted by this document or by any conduct of Vishay. Product names and markings noted herein may be trademarks of their respective owners.