

IGBT Module® 200ga16a doc

$V_{CE} = 1600\text{ V}$
 $I_C = 275\text{ A at } T_C = 25^\circ\text{C}$
 $I_C = 200\text{ A at } T_C = 80^\circ\text{C}$

- Power module
- Single switch
- Including fast free-wheel diodes
- Package with insulated metal base plate

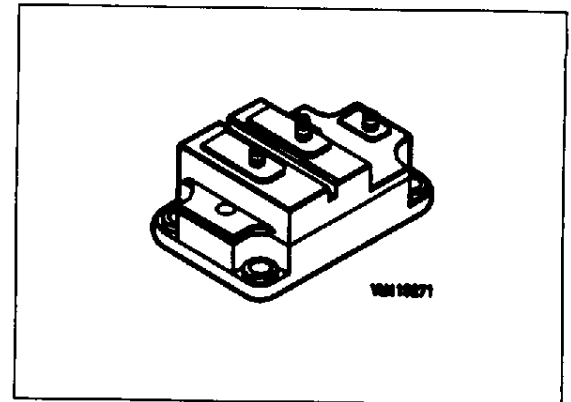

Single switch			
Type	Ordering code	Type	Ordering code
BSM 200 GA 160D	C67076-A2114-A2		

Maximum Ratings

Parameter	Symbol	Values	Unit
Collector emitter voltage	V_{CE}	1600	V
Collector gate voltage, $R_{GE}=20\text{k}\Omega$	V_{CGR}	1600	
Gate-Emitter voltage	V_{GE}	± 20	
Continuous collector current	I_C	$T_C=25^\circ\text{C}$	275
		$T_C=80^\circ\text{C}$	200
Pulsed collector current	$I_C\text{ puls}$	$T_C=25^\circ\text{C}$	550
		$T_C=80^\circ\text{C}$	400
Operating and storage temperature range	T_j, T_{stg}	-55...+150	$^\circ\text{C}$
Power dissipation, $T_C = 25^\circ\text{C}$	P_{tot}	1750	W
Thermal resistance, chip-case	R_{thJC}	≤ 0.07	K/W
Insulation test voltage ¹⁾ , $t=1\text{min.}$	V_{is}	4000	V _{ac}
Creepage distance	-	20	mm
Clearance	-	11	
DIN humidity category, DIN 40 040	-	F	--
IEC climatic category, DIN IEC 68-1	-	55/150/56	

¹⁾Insulation test voltage between collector and metal base plate referred to standard climate 23/50 in acc.with DIN 50 014, IEC, para 492.1.

Electrical Characteristics

Parameter and conditions at $T_j = 25\text{ }^\circ\text{C}$, unless otherwise specified	Symbol	Values			Unit
		min	typ	max	

Static Characteristics

Collector-emitter breakdown voltage $V_{GE}=0, I_C=4\text{mA}$	$V_{(BR)CES}$	1600	-	-	V
Gate threshold voltage $V_{GE}=V_{CE}, I_C=16\text{mA}$	$V_{GE(th)}$	4.8	5.5	6.2	
Collector-emitter saturation voltage $V_{GE}=15\text{V}, I_C=200\text{A}$ $T_j = 25\text{ }^\circ\text{C}$ $T_j = 125\text{ }^\circ\text{C}$ $T_j = 150\text{ }^\circ\text{C}$	$V_{CE(sat)}$	--	3.5 4.2 4.4	--	
Zero gate voltage collector current $V_{CE}=1600\text{V}, V_{GE}=0\text{V}$ $T_j = 25\text{ }^\circ\text{C}$ $T_j = 125\text{ }^\circ\text{C}$	I_{CES}	--	1000 4500	--	μA
Gate-emitter leakage current $V_{GE}=25\text{V}, V_{CE}=0\text{V}$	I_{CES}	--	--	100	nA

AC Characteristics

Forward transconductance $V_{CE}=20\text{V}, I_C=200\text{A}$	g_{fs}	72	--	--	S
Input capacitance $V_{CE}=25\text{V}, V_{GE}=0\text{V}, f=1\text{MHz}$	C_{iss}	--	32	--	nF
Output capacitance $V_{CE}=25\text{V}, V_{GE}=0\text{V}, f=1\text{MHz}$	C_{oss}	--	2.6	--	
Reverse transfer capacitance $V_{CE}=25\text{V}, V_{GE}=0\text{V}, f=1\text{MHz}$	C_{rss}	--	1.0	--	

Parameter and conditions at $T_1 = 25\text{ }^\circ\text{C}$, unless otherwise specified	Symbol	Values			Unit
		min	typ	max	

Switching Characteristics, Inductive Load**at $T_J = 125\text{ }^\circ\text{C}$**

Turn on delay time $V_{CC} = 1200\text{V}$, $V_{GE} = +15\text{V}$, $I_C = 200\text{ A}$ $R_{G(on)} = 15\Omega$	$t_{d(on)}$	--	0.85	--	μs
Rise time $V_{CC} = 1200\text{V}$, $V_{GE} = +15\text{V}$, $I_C = 200\text{ A}$ $R_{G(on)} = 15\Omega$	t_r	--	0.3	--	μs
Turn off delay time $V_{CC} = 1200\text{V}$, $V_{GE} = -15\text{V}$, $I_C = 200\text{ A}$ $R_{G(off)} = 3.3\Omega$	$t_{d(off)}$	--	2.5	--	μs
Fall time $V_{CC} = 1200\text{V}$, $V_{GE} = -15\text{V}$, $I_C = 200\text{ A}$ $R_{G(off)} = 3.3\Omega$	t_f	--	0.15	--	μs

Free-Wheel Diode

Diode forward voltage $I_F = 200\text{ A}$, $V_{GE} = 0\text{V}$ $T_j = 25\text{ }^\circ\text{C}$ $T_j = 125\text{ }^\circ\text{C}$	V_F	--	4.2	--	V
Reverse recovery time $I_F = 200\text{ A}$, $V_R = -1200\text{V}$ $V_{GE} = 0\text{V}$, $di_F/dt = -1000\text{A}/\mu\text{s}$ $T_j = 125\text{ }^\circ\text{C}$	t_{rr}	--	0.5	--	μs
Reverse recovery Charge $I_F = 200\text{ A}$, $V_R = -1200\text{V}$ $V_{GE} = 0\text{V}$, $di_F/dt = -1000\text{A}/\mu\text{s}$ $T_j = 125\text{ }^\circ\text{C}$	Q_{rr}	--	--	--	μC
Thermal resistance Chip-Case	R_{thJC}	--	--	0.25	K/W

Power dissipation

$P_{tot} = f(T_C)$

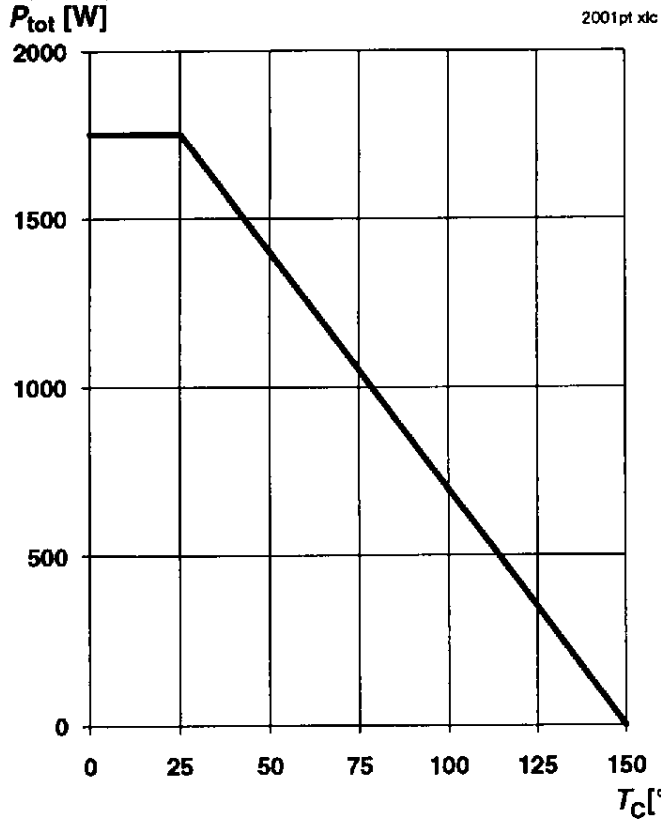

Safe operating area $I_C=f(V_{CE})$

parameter: single pulse, $T_C=25^\circ\text{C}$, $T_J \leq 150^\circ\text{C}$

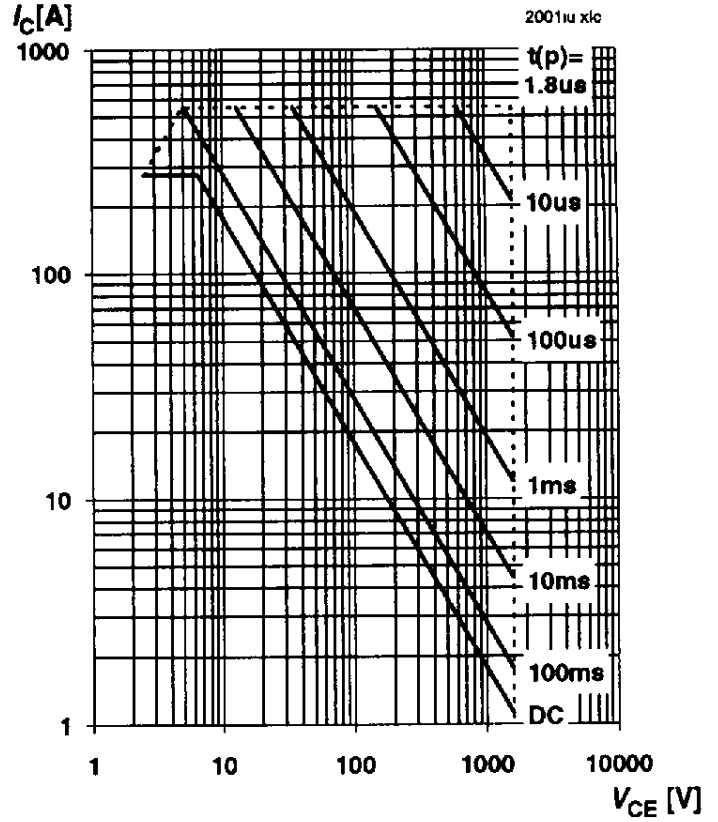

Typ output characteristics $I_C=f(V_{CE})$

parameter: $t_p=80\mu\text{s}$; $T_J=25^\circ\text{C}$

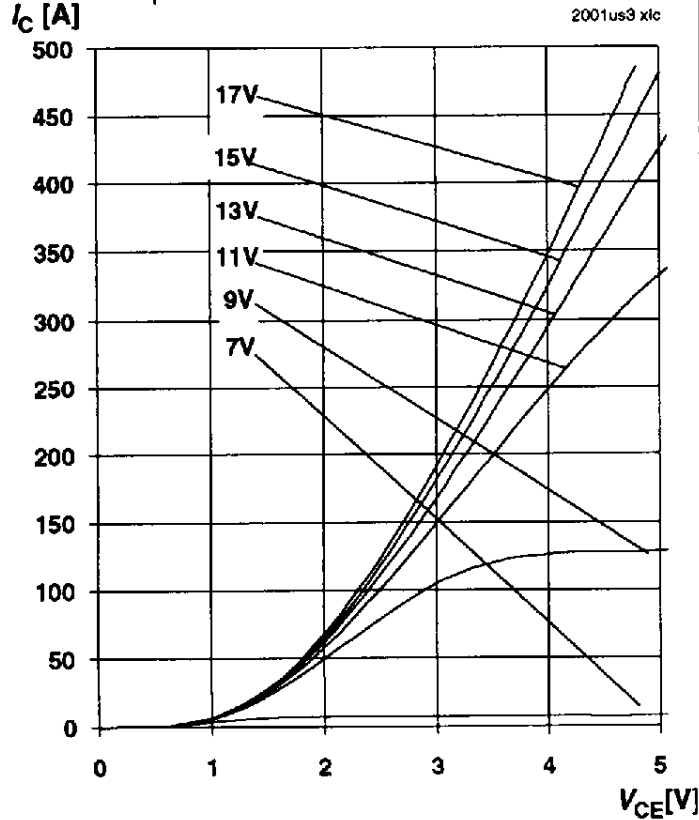

Typ output characteristics $I_C=f(V_{CE})$

parameter: $t_p=80\mu\text{s}$; $T_J < 125^\circ\text{C}$

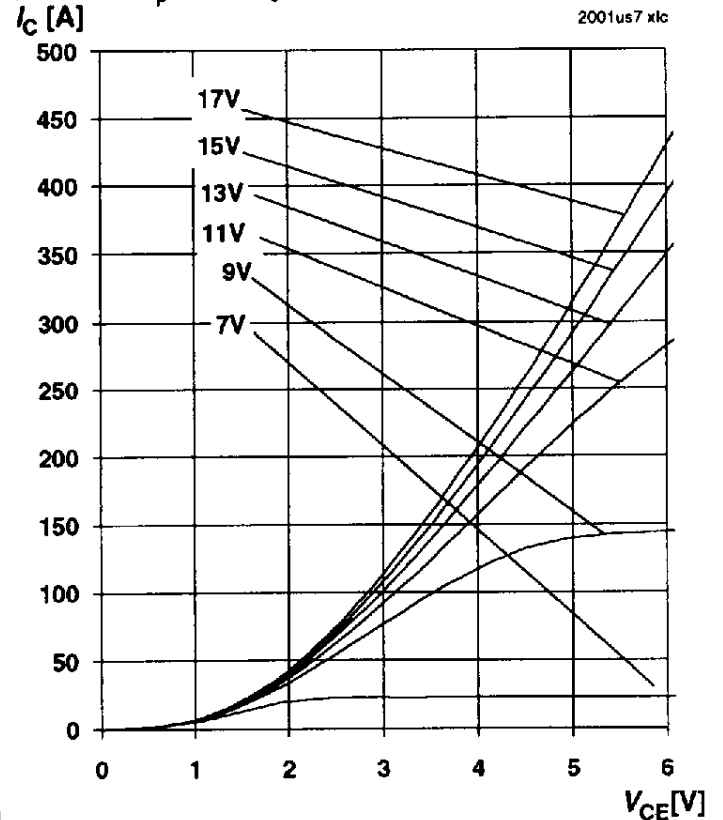

Reverse biased safe operating area

$I_C = f(V_{CE})$, parameter: $T_J = 150^\circ\text{C}$
 $V_{GE} = 15\text{V}$, $R_{g(\text{off})} = 3.3\Omega$

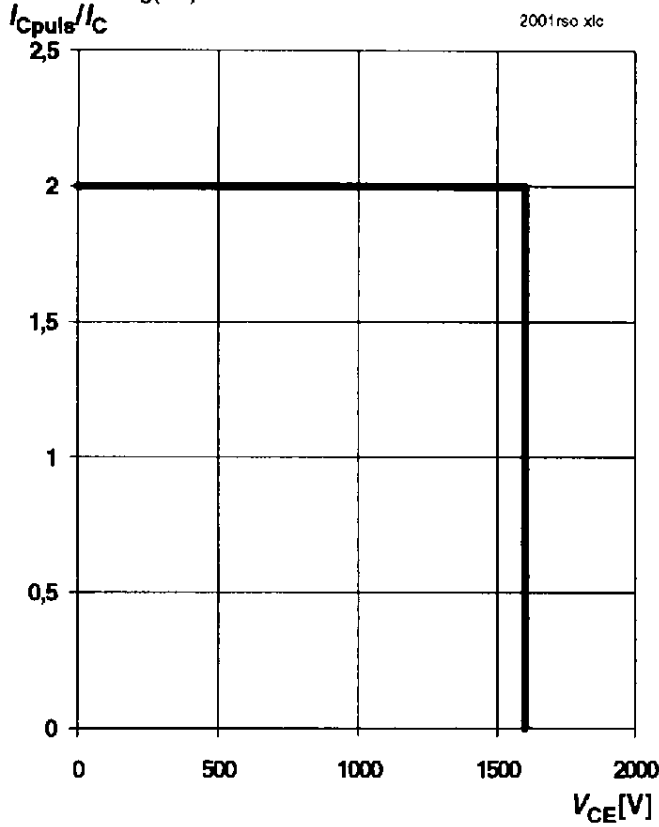

Safe operating area, SHORT CIRCUIT

$I_C = f(V_{CE})$, $V_{GE} = \pm 15\text{V}$, $T_J \leq 150^\circ\text{C}$
 $t_{sc} \leq 10\mu\text{s}$, $L < 50\text{nH}$

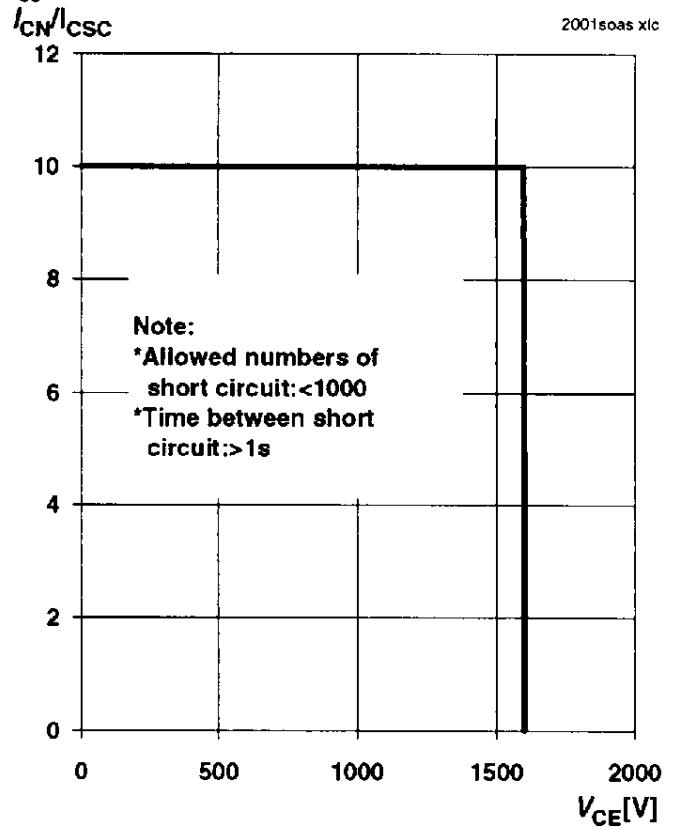

Typ. capacitances

Parameter: $V_{GE} = 0$, $f = 1\text{ MHz}$

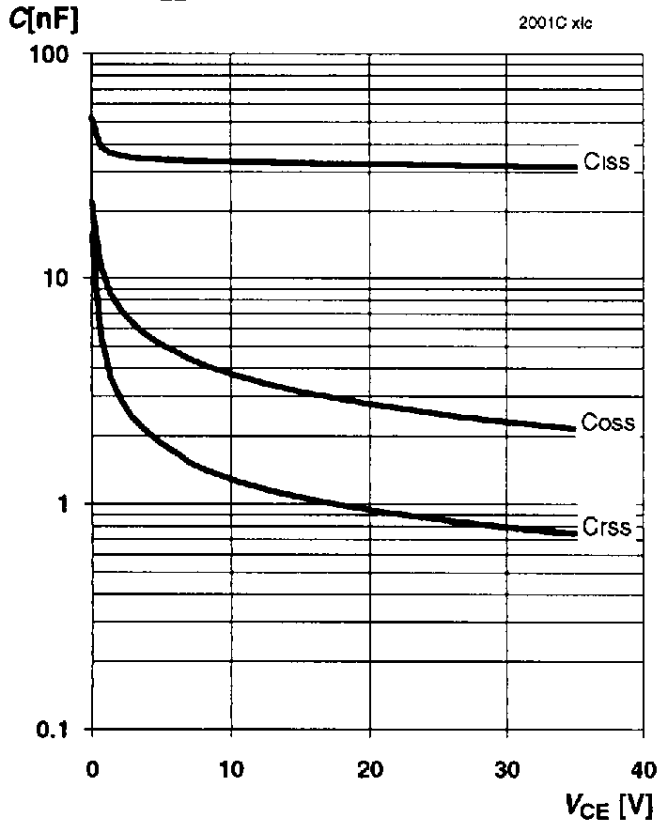

Transient thermal impedance

$Z_{thJC} = f(t_p)$, parameter: $D = t_p/T$

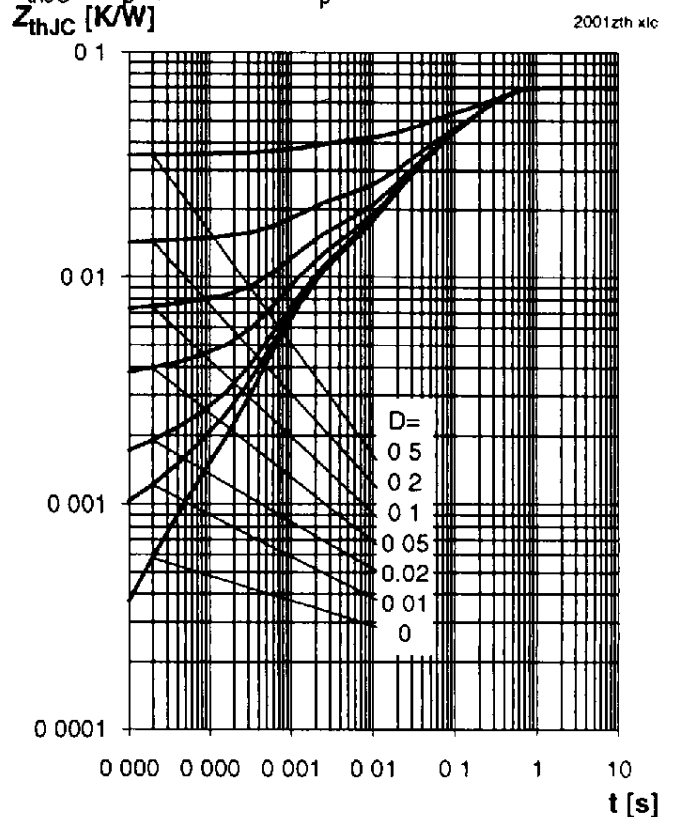

Collector current $I_C=f(T_C)$
parameter: $V_{GE} \geq 15V, T_J = 150^\circ$

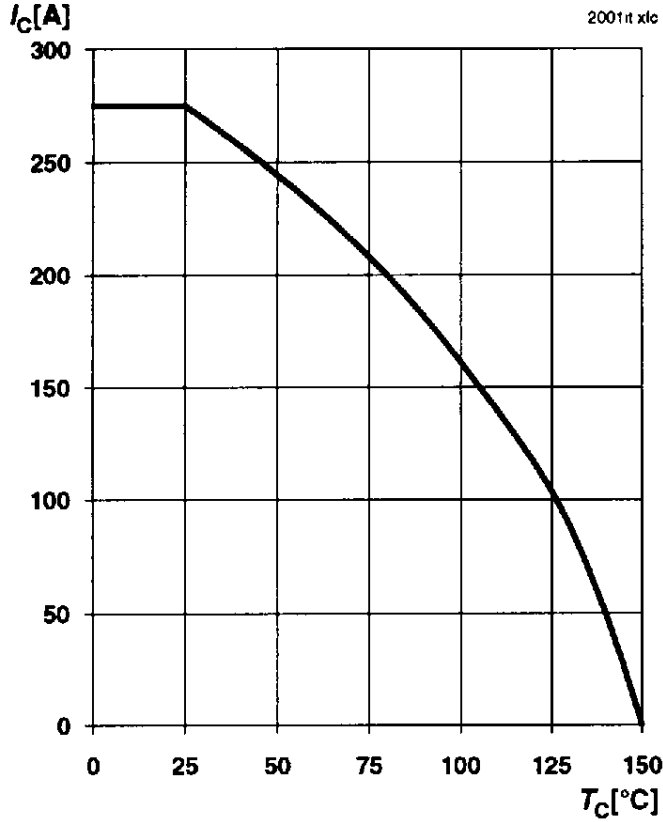

Typ. gate charge, $V_{GE} f(Q_G)$

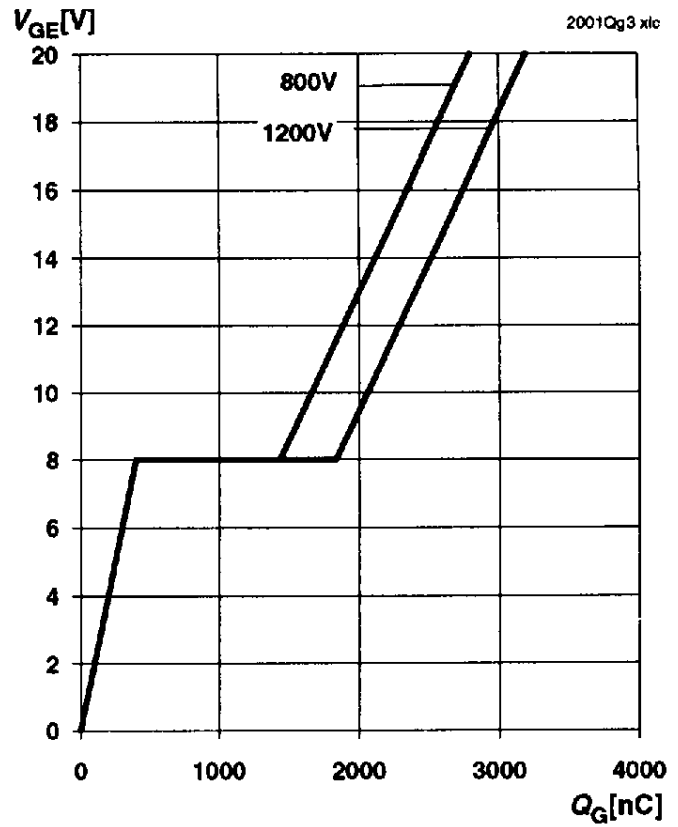

Typ. transfer characteristics $I_C=f(V_{GE})$
parameter: $t_p=80\mu s, V_{CE}=20V$

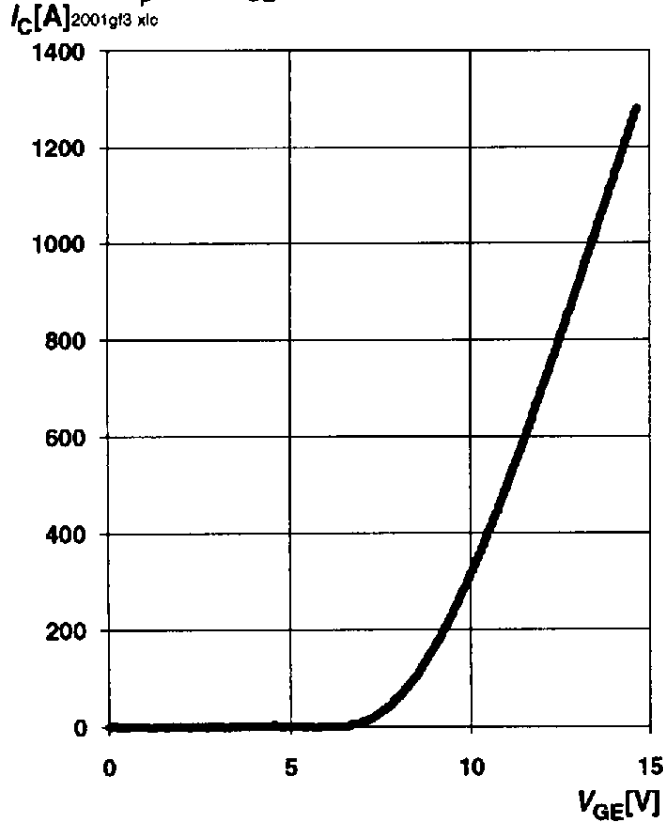

Typ. switching time $t=f(R_G)$ Inductive load
parameter: $T_J=125^\circ C, V_{CE}=1200V, V_{GE}=\pm 15V$

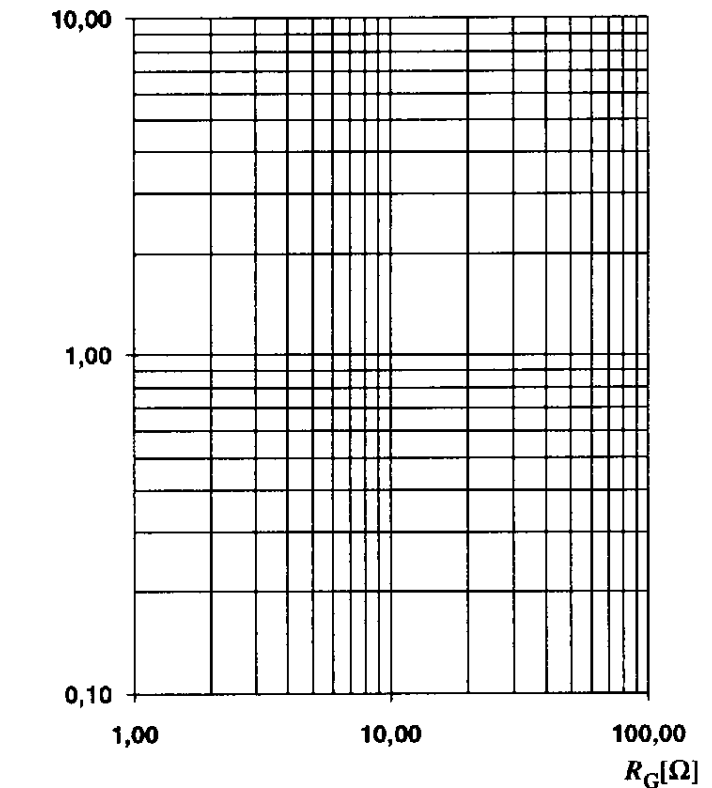

Typ. switching time $t = f(I_C)$
 Inductive load, parameter: $T_J = 125^\circ\text{C}$
 $V_{CE} = 1200\text{V}$, $V_{GE} = \pm 15\text{V}$, $R_{Gon} = 47\Omega$, $R_{Goff} = 3.3\Omega$
 $t [\mu\text{s}]$

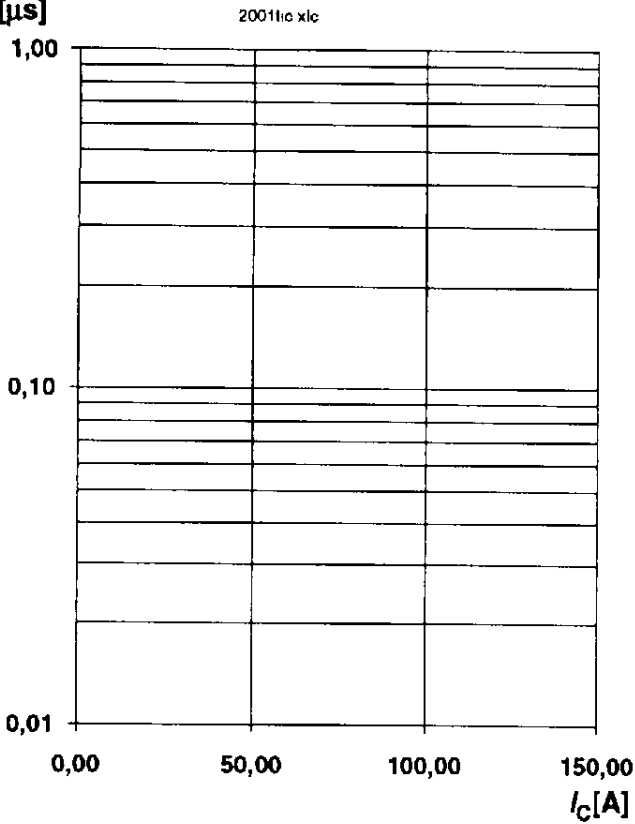

T.

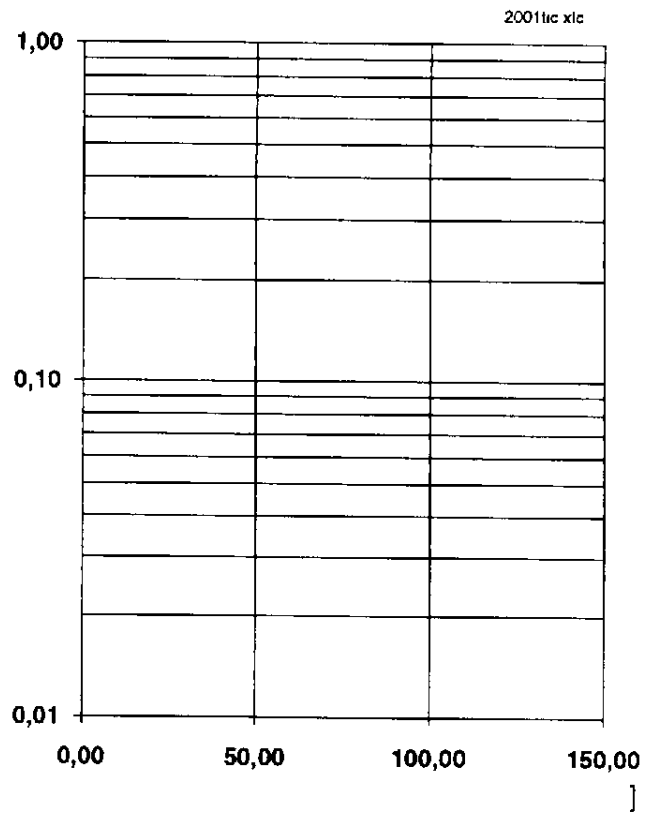

Forward characteristics of fast recovery reverse diode

$I_F = f(V_F)$, parameter: T_J

$I_C [\text{A}]$

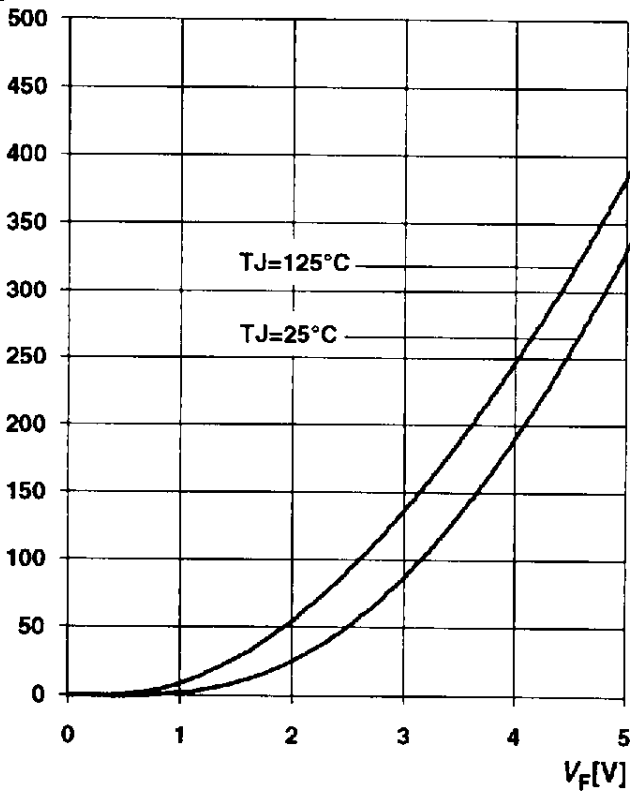

Package Outlines and Configuration

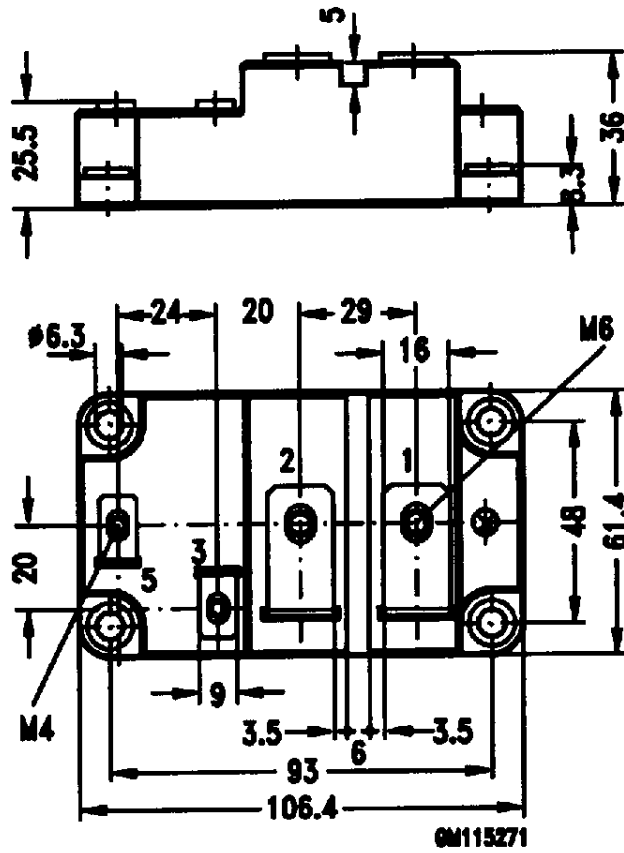

Circuit

