

## Technische Information / Technical Information

eupec

IGBT-Module  
IGBT-Modules

BSM25GD120DLCE3224

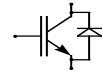

## Höchstzulässige Werte / Maximum rated values

## Elektrische Eigenschaften / Electrical properties

Kollektor-Emitter-Sperrspannung collector-emitter voltage		$V_{CES}$	1200	V
Kollektor-Dauergleichstrom DC-collector current	$T_C = 80^\circ\text{C}$	$I_{C,nom.}$	25	A
	$T_C = 25^\circ\text{C}$	$I_C$	50	A
Periodischer Kollektor Spitzenstrom repetitive peak collector current	$t_p = 1\text{ ms}, T_C = 80^\circ\text{C}$	$I_{CRM}$	50	A
Gesamt-Verlustleistung total power dissipation	$T_C = 25^\circ\text{C}, \text{ Transistor}$	$P_{tot}$	200	W
Gate-Emitter-Spitzenspannung gate-emitter peak voltage		$V_{GES}$	+/- 20V	V
Dauergleichstrom DC forward current		$I_F$	25	A
Periodischer Spitzenstrom repetitive peak forw. current	$t_p = 1\text{ ms}$	$I_{FRM}$	50	A
Grenzlastintegral der Diode $I^2t$ - value, Diode	$V_R = 0\text{V}, t_p = 10\text{ms}, T_{vj} = 125^\circ\text{C}$	$I^2t$	230	$\text{A}^2\text{s}$
Isolations-Prüfspannung insulation test voltage	RMS, $f = 50\text{ Hz}, t = 1\text{ min.}$	$V_{ISOL}$	2,5	kV

## Charakteristische Werte / Characteristic values

## Transistor / Transistor

min. typ. max.

			min.	typ.	max.	
Kollektor-Emitter Sättigungsspannung collector-emitter saturation voltage	$I_C = 25\text{A}, V_{GE} = 15\text{V}, T_{vj} = 25^\circ\text{C}$	$V_{CE\text{ sat}}$	-	2,1	2,6	V
	$I_C = 25\text{A}, V_{GE} = 15\text{V}, T_{vj} = 125^\circ\text{C}$		-	2,4	2,9	V
Gate-Schwellenspannung gate threshold voltage	$I_C = 1\text{mA}, V_{CE} = V_{GE}, T_{vj} = 25^\circ\text{C}$	$V_{GE(th)}$	4,5	5,5	6,5	V
Gateladung gate charge	$V_{GE} = -15\text{V}...+15\text{V}$	$Q_G$	-	0,26	-	$\mu\text{C}$
Eingangskapazität input capacitance	$f = 1\text{MHz}, T_{vj} = 25^\circ\text{C}, V_{CE} = 25\text{V}, V_{GE} = 0\text{V}$	$C_{ies}$	-	1,65	-	nF
Rückwirkungskapazität reverse transfer capacitance	$f = 1\text{MHz}, T_{vj} = 25^\circ\text{C}, V_{CE} = 25\text{V}, V_{GE} = 0\text{V}$	$C_{res}$	-	0,11	-	nF
Kollektor-Emitter Reststrom collector-emitter cut-off current	$V_{CE} = 1200\text{V}, V_{GE} = 0\text{V}, T_{vj} = 25^\circ\text{C}$	$I_{CES}$	-	2	78	$\mu\text{A}$
	$V_{CE} = 1200\text{V}, V_{GE} = 0\text{V}, T_{vj} = 125^\circ\text{C}$		-	200	-	$\mu\text{A}$
Gate-Emitter Reststrom gate-emitter leakage current	$V_{CE} = 0\text{V}, V_{GE} = 20\text{V}, T_{vj} = 25^\circ\text{C}$	$I_{GES}$	-	-	400	nA

prepared by: Mark Münzer

date of publication: 09.09.1999

approved by: M. Hierholzer

revision: 2

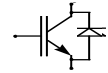

### Charakteristische Werte / Characteristic values

Transistor / Transistor			min.	typ.	max.	
Einschaltverzögerungszeit (ind. Last) turn on delay time (inductive load)	$I_C = 25A, V_{CC} = 600V$	$t_{d,on}$	-	0,06	-	$\mu s$
	$V_{GE} = \pm 15V, R_G = 33\Omega, T_{vj} = 25^\circ C$					
	$V_{GE} = \pm 15V, R_G = 33\Omega, T_{vj} = 125^\circ C$			0,07		$\mu s$
Anstiegszeit (induktive Last) rise time (inductive load)	$I_C = 25A, V_{CC} = 600V$	$t_r$	-	0,05	-	$\mu s$
	$V_{GE} = \pm 15V, R_G = 33\Omega, T_{vj} = 25^\circ C$					
	$V_{GE} = \pm 15V, R_G = 33\Omega, T_{vj} = 125^\circ C$			0,05		$\mu s$
Abschaltverzögerungszeit (ind. Last) turn off delay time (inductive load)	$I_C = 25A, V_{CC} = 600V$	$t_{d,off}$	-	0,27	-	$\mu s$
	$V_{GE} = \pm 15V, R_G = 33\Omega, T_{vj} = 25^\circ C$					
	$V_{GE} = \pm 15V, R_G = 33\Omega, T_{vj} = 125^\circ C$			0,32		$\mu s$
Fallzeit (induktive Last) fall time (inductive load)	$I_C = 25A, V_{CC} = 600V$	$t_f$	-	0,03	-	$\mu s$
	$V_{GE} = \pm 15V, R_G = 33\Omega, T_{vj} = 25^\circ C$					
	$V_{GE} = \pm 15V, R_G = 33\Omega, T_{vj} = 125^\circ C$			0,06		$\mu s$
Einschaltverlustenergie pro Puls turn-on energy loss per pulse	$I_C = 25A, V_{CC} = 600V, V_{GE} = 15V$ $R_G = 33\Omega, T_{vj} = 125^\circ C, L_S = 130nH$	$E_{on}$	-	3,3	-	mWs
Abschaltverlustenergie pro Puls turn-off energy loss per pulse	$I_C = 25A, V_{CC} = 600V, V_{GE} = 15V$ $R_G = 33\Omega, T_{vj} = 125^\circ C, L_S = 130nH$	$E_{off}$	-	2,9	-	mWs
Kurzschlußverhalten SC Data	$t_p \leq 10\mu sec, V_{GE} \leq 15V, R_G = 33\Omega$ $T_{vj} \leq 125^\circ C, V_{CC} = 900V, V_{CEmax} = V_{CES} - L_{sCE} \cdot di/dt$	$I_{SC}$	-	220	-	A
Modulinduktivität stray inductance module		$L_{sCE}$	-	60	-	nH
Modul Leitungswiderstand, Anschlüsse – Chip module lead resistance, terminals – chip	$T_C = 25^\circ C$	$R_{CC+EE}$	-	8,0	-	m $\Omega$

### Charakteristische Werte / Characteristic values

Diode / Diode			min.	typ.	max.	
Durchlaßspannung forward voltage	$I_F = 25A, V_{GE} = 0V, T_{vj} = 25^\circ C$	$V_F$	-	1,8	2,3	V
	$I_F = 25A, V_{GE} = 0V, T_{vj} = 125^\circ C$			1,7	2,2	V
Rückstromspitze peak reverse recovery current	$I_F = 25A, -di_F/dt = 650A/\mu sec$	$I_{RM}$	-	25	-	A
	$V_R = 600V, V_{GE} = -15V, T_{vj} = 25^\circ C$			32	-	A
	$V_R = 600V, V_{GE} = -15V, T_{vj} = 125^\circ C$					
Sperrverzögerungsladung recovered charge	$I_F = 25A, -di_F/dt = 650A/\mu sec$	$Q_r$	-	2,5	-	$\mu As$
	$V_R = 600V, V_{GE} = -15V, T_{vj} = 25^\circ C$			5,4	-	$\mu As$
	$V_R = 600V, V_{GE} = -15V, T_{vj} = 125^\circ C$					
Abschaltenergie pro Puls reverse recovery energy	$I_F = 25A, -di_F/dt = 650A/\mu sec$	$E_{rec}$	-	1	-	mWs
	$V_R = 600V, V_{GE} = -15V, T_{vj} = 25^\circ C$			2,2	-	mWs
	$V_R = 600V, V_{GE} = -15V, T_{vj} = 125^\circ C$					

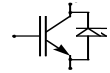

### Thermische Eigenschaften / Thermal properties

			min.	typ.	max.	
Innerer Wärmewiderstand thermal resistance, junction to case	Transistor / transistor, DC	$R_{thJC}$	-	-	0,6	K/W
	Diode/Diode, DC		-	-	1	K/W
Übergangs-Wärmewiderstand thermal resistance, case to heatsink	pro Modul / per module $\lambda_{Paste} = 1 \text{ W/m} \cdot \text{K} / \lambda_{grease} = 1 \text{ W/m} \cdot \text{K}$	$R_{thCK}$	-	0,02	-	K/W
Höchstzulässige Sperrschichttemperatur maximum junction temperature		$T_{vj}$	-	-	150	°C
Betriebstemperatur operation temperature		$T_{op}$	-40	-	125	°C
Lagertemperatur storage temperature		$T_{stg}$	-40	-	150	°C

### Mechanische Eigenschaften / Mechanical properties

Gehäuse, siehe Anlage case, see appendix					
Innere Isolation internal insulation				$Al_2O_3$	
CTI comperative tracking index				225	
Anzugsdrehmoment f. mech. Befestigung mounting torque		M1	3	6	Nm
Anzugsdrehmoment f. elektr. Anschlüsse terminal connection torque	terminals M6	M2			Nm
Gewicht weight		G		180	g

Mit dieser technischen Information werden Halbleiterbauelemente spezifiziert, jedoch keine Eigenschaften zugesichert. Sie gilt in Verbindung mit den zugehörigen Technischen Erläuterungen.

This technical information specifies semiconductor devices but promises no characteristics. It is valid in combination with the belonging technical notes.

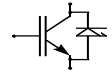

**Ausgangskennlinie (typisch)**  
**Output characteristic (typical)**

$I_c = f(V_{CE})$   
 $V_{GE} = 15V$

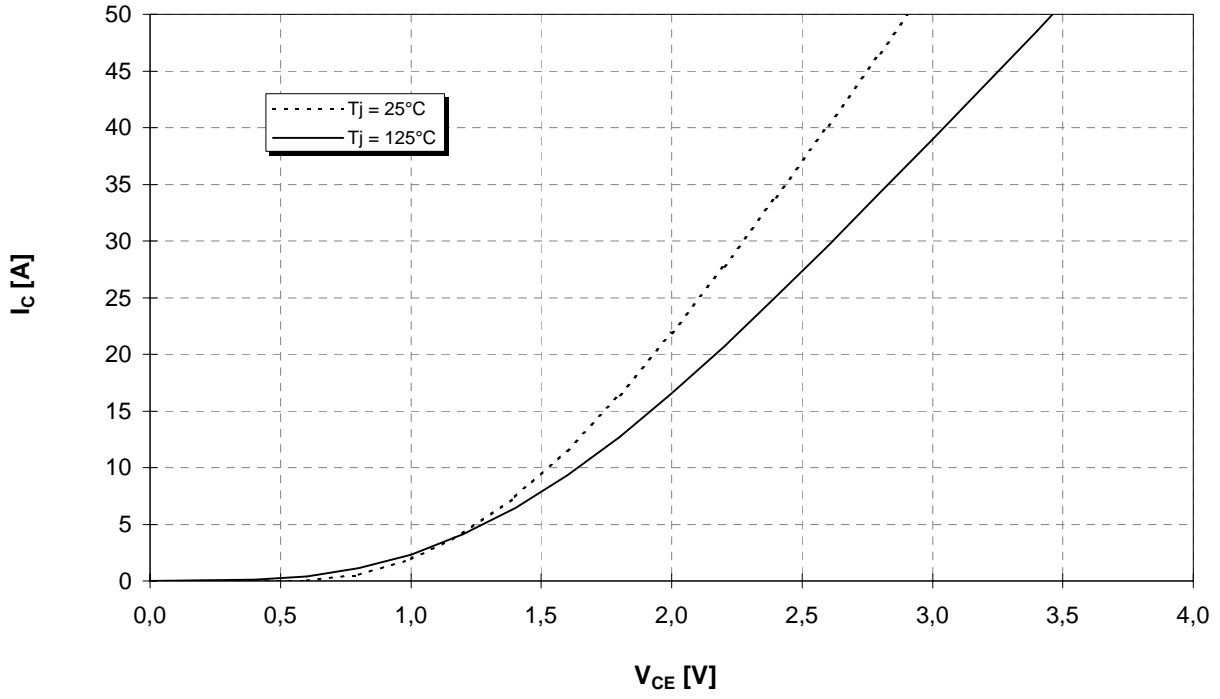

**Ausgangskennlinienfeld (typisch)**  
**Output characteristic (typical)**

$I_c = f(V_{CE})$   
 $T_{vj} = 125^\circ C$

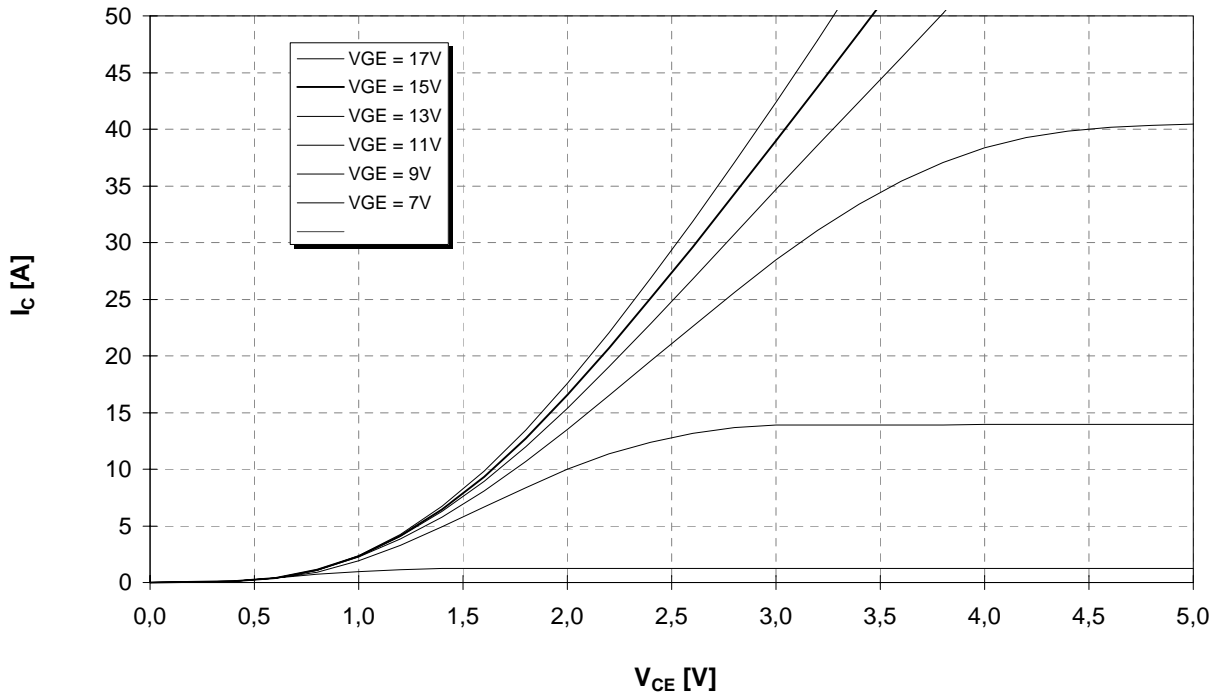

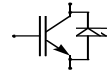

Übertragungscharakteristik (typisch)  
Transfer characteristic (typical)

$I_c = f(V_{GE})$

$V_{CE} = 20V$

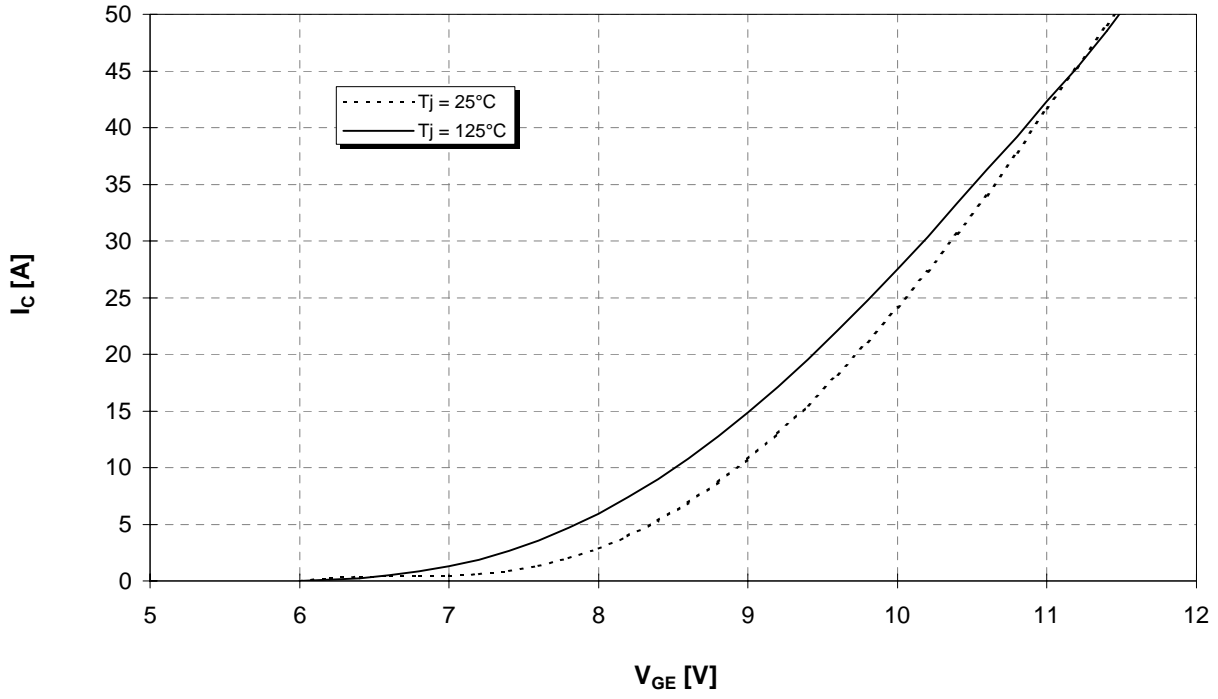

Durchlaßkennlinie der Inversdiode (typisch)  
Forward characteristic of inverse diode (typical)

$I_F = f(V_F)$

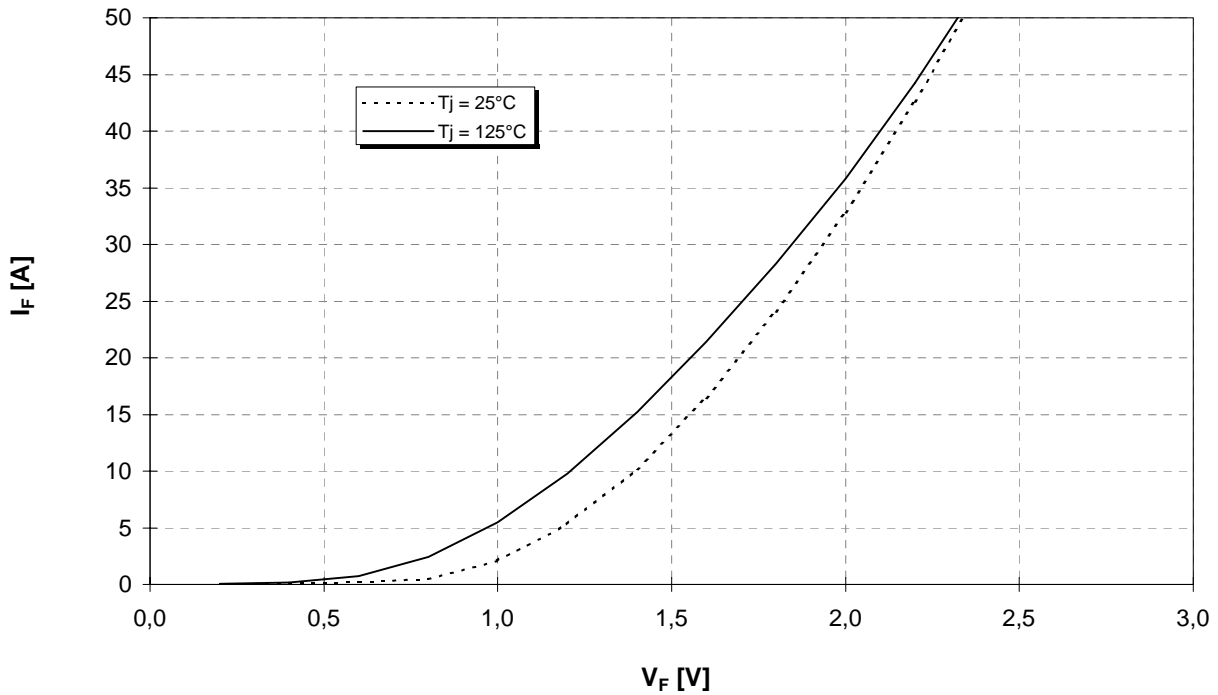

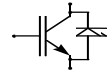

**Schaltverluste (typisch)  $E_{on} = f(I_C)$ ,  $E_{off} = f(I_C)$ ,  $E_{rec} = f(I_C)$**   
**Switching losses (typical)  $V_{GE}=15V$ ,  $R_{gon} = R_{goff} = 33 \Omega$ ,  $V_{CE} = 600V$ ,  $T_j = 125^\circ C$**

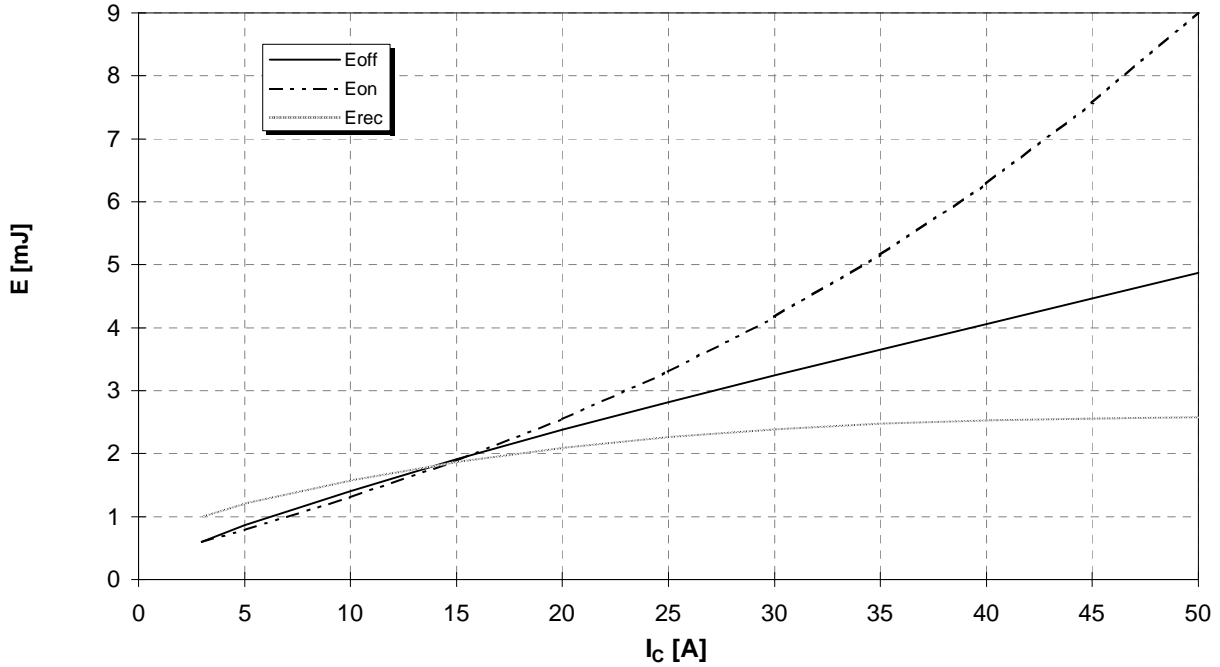

**Schaltverluste (typisch)  $E_{on} = f(R_G)$ ,  $E_{off} = f(R_G)$ ,  $E_{rec} = f(R_G)$**   
**Switching losses (typical)  $V_{GE}=15V$ ,  $I_C = 25A$ ,  $V_{CE} = 600V$ ,  $T_j = 125^\circ C$**

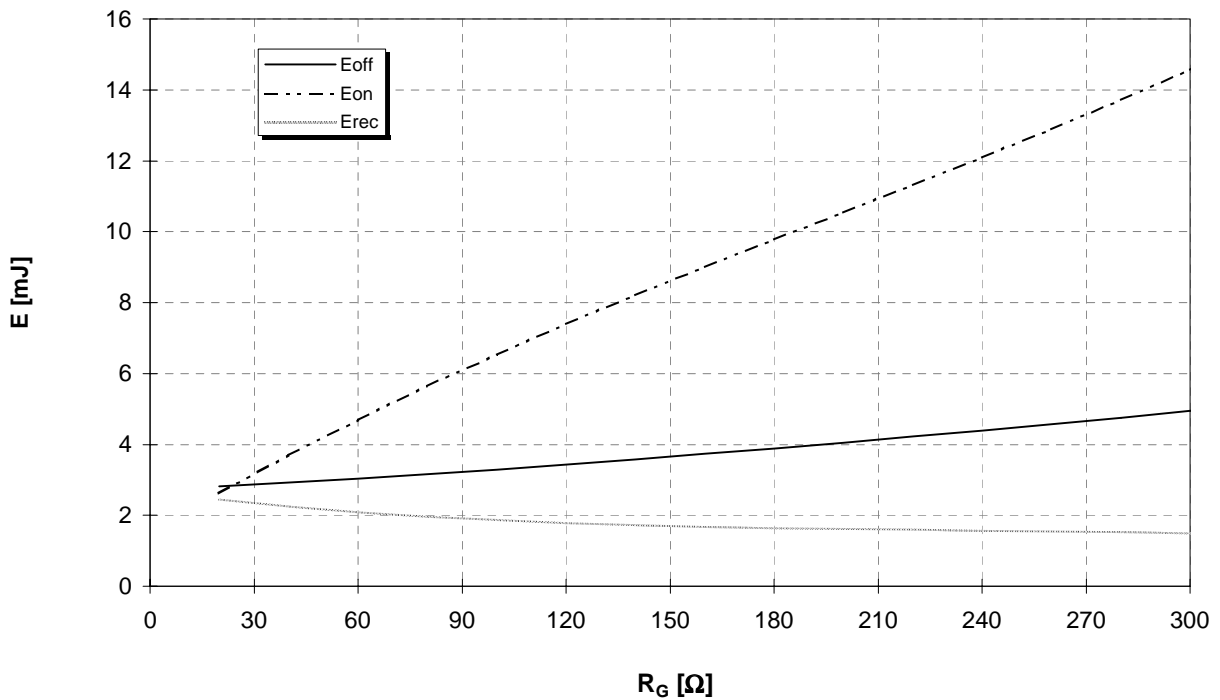

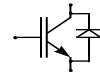

**Transienter Wärmewiderstand  
Transient thermal impedance**

$Z_{thJC} = f(t)$

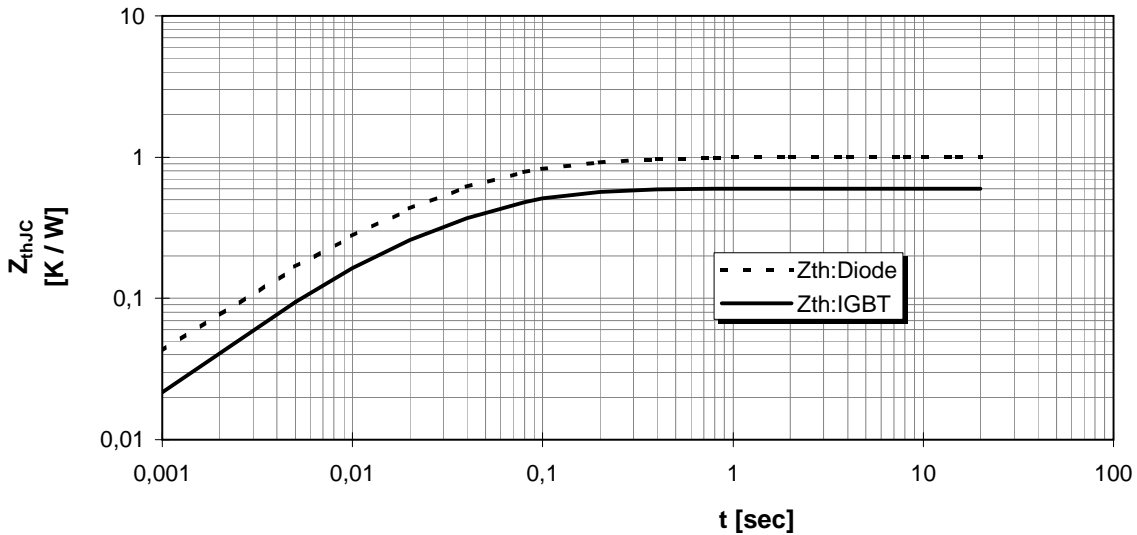

i	1	2	3	4
$r_i$ [K/kW] : IGBT	117,12	394,24	31,28	57,36
$\tau_i$ [sec] : IGBT	0,009	0,045	0,073	0,229
$r_i$ [K/kW] : Diode	59,25	436,14	387,87	116,74
$\tau_i$ [sec] : Diode	0,003	0,022	0,064	0,344

**Sicherer Arbeitsbereich (RBSOA)**

**Reverse bias safe operation area (RBSOA)**

$V_{GE} = 15V, R_g = 33 \text{ Ohm}, T_v = 125^\circ C$

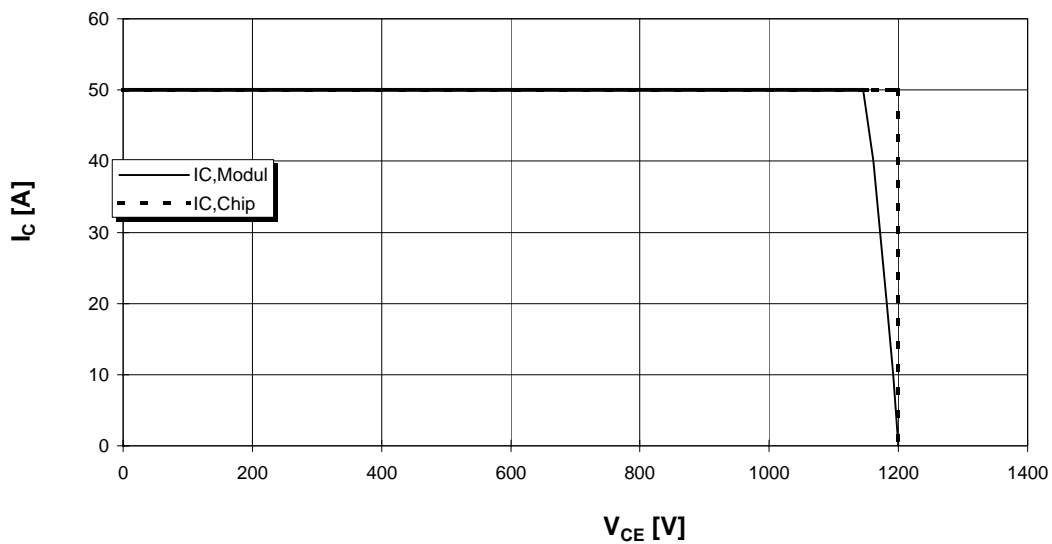

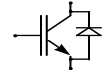

# Econo 2 (shortpin)

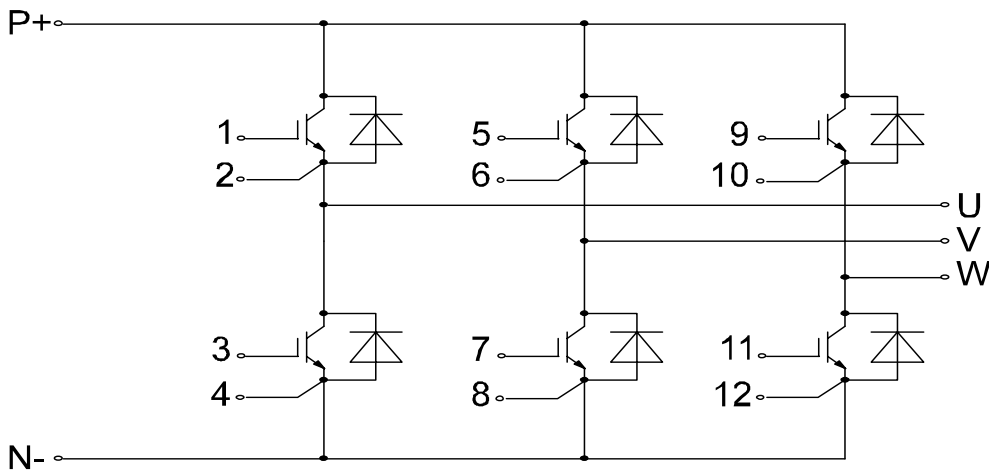
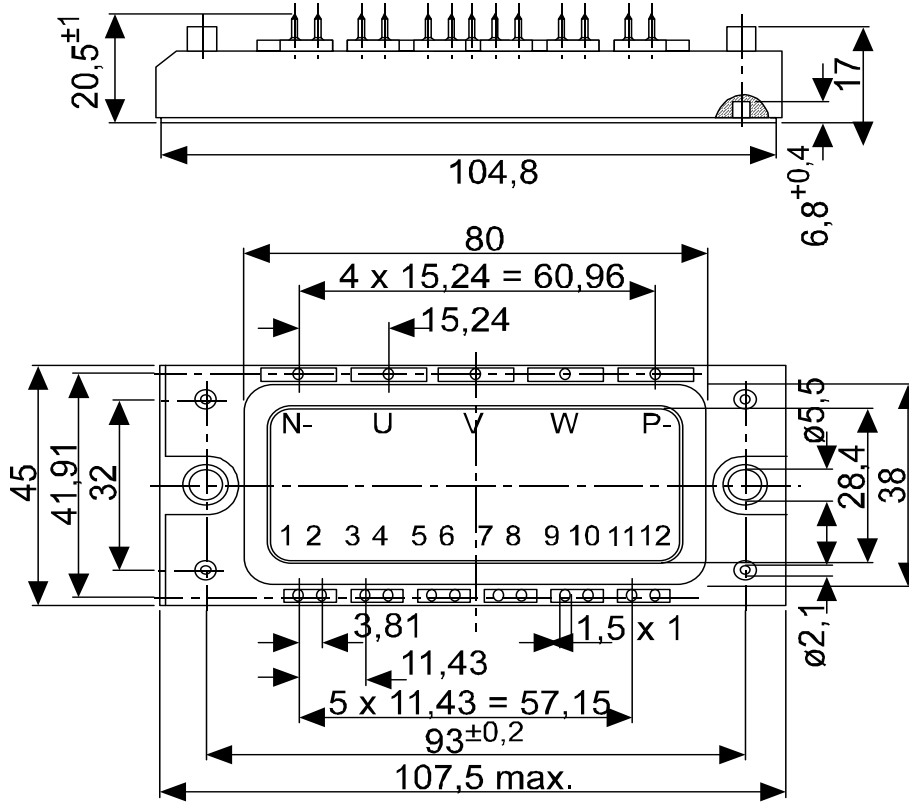



## **Terms & Conditions of Usage**

### **Attention**

The present product data is exclusively subscribed to technically experienced staff. This Data Sheet is describing the specification of the products for which a warranty is granted exclusively pursuant the terms and conditions of the supply agreement. There will be no guarantee of any kind for the product and its specifications. Changes to the Data Sheet are reserved.

You and your technical departments will have to evaluate the suitability of the product for the intended application and the completeness of the product data with respect to such application. Should you require product information in excess of the data given in the Data Sheet, please contact your local Sales Office via "[www.eupec.com / sales & contact](http://www.eupec.com / sales & contact)".

### **Warning**

Due to technical requirements the products may contain dangerous substances. For information on the types in question please contact your local Sales Office via "[www.eupec.com / sales & contact](http://www.eupec.com / sales & contact)".