

Technische Information / Technical Information

IGBT-Module
IGBT-Modules

BSM300GA120DLC

eupec



vorläufige Daten
preliminary data

Höchstzulässige Werte / Maximum rated values

Elektrische Eigenschaften / Electrical properties

Kollektor-Emitter-Sperrspannung collector-emitter voltage		V_{CES}	1200	V
Kollektor-Dauergleichstrom DC-collector current	$T_C = 80\text{ °C}$ $T_C = 25\text{ °C}$	$I_{C,nom.}$ I_C	300 570	A A
Periodischer Kollektor Spitzenstrom repetitive peak collector current	$t_p = 1\text{ ms}, T_C = 80\text{ °C}$	I_{CRM}	600	A
Gesamt-Verlustleistung total power dissipation	$T_C = 25\text{ °C}, \text{ Transistor}$	P_{tot}	2270	W
Gate-Emitter-Spitzenspannung gate-emitter peak voltage		V_{GES}	+/- 20V	V
Dauergleichstrom DC forward current		I_F	300	A
Periodischer Spitzenstrom repetitive peak forw. current	$t_p = 1\text{ ms}$	I_{FRM}	600	A
Grenzlastintegral der Diode I^2t - value, Diode	$V_R = 0V, t_p = 10ms, T_{vj} = 125\text{ °C}$	I^2t	19	kJ^2s
Isolations-Prüfspannung insulation test voltage	RMS, $f = 50\text{ Hz}, t = 1\text{ min.}$	V_{ISOL}	2,5	kV

Charakteristische Werte / Characteristic values

Transistor / Transistor

			min.	typ.	max.	
Kollektor-Emitter Sättigungsspannung collector-emitter saturation voltage	$I_C = 300A, V_{GE} = 15V, T_{vj} = 25\text{ °C}$	$V_{CE\ sat}$	-	2,1	2,6	V
	$I_C = 300A, V_{GE} = 15V, T_{vj} = 125\text{ °C}$		-	2,4	t.b.d.	V
Gate-Schwellenspannung gate threshold voltage	$I_C = 12mA, V_{CE} = V_{GE}, T_{vj} = 25\text{ °C}$	$V_{GE(th)}$	4,5	5,5	6,5	V
Gateladung gate charge	$V_{GE} = -15V...+15V$	Q_G	-	t.b.d.	-	μC
Eingangskapazität input capacitance	$f = 1MHz, T_{vj} = 25\text{ °C}, V_{CE} = 25V, V_{GE} = 0V$	C_{ies}	-	22	-	nF
Rückwirkungskapazität reverse transfer capacitance	$f = 1MHz, T_{vj} = 25\text{ °C}, V_{CE} = 25V, V_{GE} = 0V$	C_{res}	-	t.b.d.	-	nF
Kollektor-Emitter Reststrom collector-emitter cut-off current	$V_{CE} = 1200V, V_{GE} = 0V, T_{vj} = 25\text{ °C}$	I_{CES}	-	20	500	μA
	$V_{CE} = 1200V, V_{GE} = 0V, T_{vj} = 125\text{ °C}$		-	500	-	μA
Gate-Emitter Reststrom gate-emitter leakage current	$V_{CE} = 0V, V_{GE} = 20V, T_{vj} = 25\text{ °C}$	I_{GES}	-	-	400	nA

prepared by: Mark Münzer

date of publication: 18.02.1999

approved by: Jens Thureau

revision: 1

Technische Information / Technical Information

IGBT-Module
IGBT-Modules

BSM300GA120DLC

eupec



vorläufige Daten
preliminary data

Charakteristische Werte / Characteristic values

Transistor / Transistor

			min.	typ.	max.	
Einschaltverzögerungszeit (ind. Last) turn on delay time (inductive load)	$I_C = 300A, V_{CC} = 600V$	$t_{d,on}$	-	0,09	-	μs
	$V_{GE} = \pm 15V, R_G = 3,3\Omega, T_{vj} = 25^\circ C$		-	0,09	-	μs
Anstiegszeit (induktive Last) rise time (inductive load)	$I_C = 300A, V_{CC} = 600V$	t_r	-	0,09	-	μs
	$V_{GE} = \pm 15V, R_G = 3,3\Omega, T_{vj} = 125^\circ C$		-	0,1	-	μs
Abschaltverzögerungszeit (ind. Last) turn off delay time (inductive load)	$I_C = 300A, V_{CC} = 600V$	$t_{d,off}$	-	0,54	-	μs
	$V_{GE} = \pm 15V, R_G = 3,3\Omega, T_{vj} = 125^\circ C$		-	0,59	-	μs
Fallzeit (induktive Last) fall time (inductive load)	$I_C = 300A, V_{CC} = 600V$	t_f	-	0,06	-	μs
	$V_{GE} = \pm 15V, R_G = 3,3\Omega, T_{vj} = 125^\circ C$		-	0,09	-	μs
Einschaltverlustenergie pro Puls turn-on energy loss per pulse	$I_C = 300A, V_{CC} = 600V, V_{GE} = 15V$ $R_G = 3,3\Omega, T_{vj} = 125^\circ C, L_S = 90nH$	E_{on}	-	29	-	mWs
Abschaltverlustenergie pro Puls turn-off energy loss per pulse	$I_C = 300A, V_{CC} = 600V, V_{GE} = 15V$ $R_G = 3,3\Omega, T_{vj} = 125^\circ C, L_S = 90nH$	E_{off}	-	39	-	mWs
Kurzschlußverhalten SC Data	$t_p \leq 10\mu sec, V_{GE} \leq 15V, R_G = 3,3\Omega$ $T_{vj} \leq 125^\circ C, V_{CC} = 900V, V_{CEmax} = V_{CES} - L_{sCE} \cdot di/dt$	I_{SC}	-	1800	-	A
Modulinduktivität stray inductance module		L_{sCE}	-	16	-	nH
Modul Leitungswiderstand, Anschlüsse – Chip module lead resistance, terminals – chip	$T_C = 25^\circ C$	R_{CC+EE}	-	0,5	-	m Ω

Charakteristische Werte / Characteristic values

Diode / Diode

			min.	typ.	max.	
Durchlaßspannung forward voltage	$I_F = 300A, V_{GE} = 0V, T_{vj} = 25^\circ C$	V_F	-	1,8	2,3	V
	$I_F = 300A, V_{GE} = 0V, T_{vj} = 125^\circ C$		-	1,7	t.b.d.	V
Rückstromspitze peak reverse recovery current	$I_F = 300A, -di_F/dt = 3100A/\mu sec$	I_{RM}	-	250	-	A
	$V_R = 600V, V_{GE} = -15V, T_{vj} = 25^\circ C$ $V_R = 600V, V_{GE} = -15V, T_{vj} = 125^\circ C$		-	335	-	A
Sperrverzögerungsladung recovered charge	$I_F = 300A, -di_F/dt = 3100A/\mu sec$	Q_r	-	29	-	μAs
	$V_R = 600V, V_{GE} = -15V, T_{vj} = 25^\circ C$ $V_R = 600V, V_{GE} = -15V, T_{vj} = 125^\circ C$		-	60	-	μAs
Abschaltenergie pro Puls reverse recovery energy	$I_F = 300A, -di_F/dt = 3100A/\mu sec$	E_{rec}	-	11	-	mWs
	$V_R = 600V, V_{GE} = -15V, T_{vj} = 25^\circ C$ $V_R = 600V, V_{GE} = -15V, T_{vj} = 125^\circ C$		-	25	-	mWs

Technische Information / Technical Information

IGBT-Module
IGBT-Modules

BSM300GA120DLC

eupec

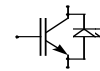

vorläufige Daten preliminary data

Thermische Eigenschaften / Thermal properties

		min. typ. max.				
Innerer Wärmewiderstand thermal resistance, junction to case	Transistor / transistor, DC	R_{thJC}	-	-	0,055	K/W
	Diode/Diode, DC		-	-	0,125	K/W
Übergangs-Wärmewiderstand thermal resistance, case to heatsink	pro Modul / per module $\lambda_{Paste} = 1 \text{ W/m} \cdot \text{K} / \lambda_{grease} = 1 \text{ W/m} \cdot \text{K}$	R_{thCK}	-	0,010	-	K/W
Höchstzulässige Sperrschichttemperatur maximum junction temperature		T_{vj}	-	-	150	°C
Betriebstemperatur operation temperature		T_{op}	-40	-	125	°C
Lagertemperatur storage temperature		T_{stg}	-40	-	150	°C

Mechanische Eigenschaften / Mechanical properties

Gehäuse, siehe Anlage case, see appendix					
Innere Isolation internal insulation				Al_2O_3	
Kriechstrecke creepage distance				20	mm
Luftstrecke clearance				11	mm
CTI comperative tracking index				225	
Anzugsdrehmoment f. mech. Befestigung mounting torque	screw M5	M1	3	6	Nm
Anzugsdrehmoment f. elektr. Anschlüsse terminal connection torque	terminals M6		2,5	5,0	Nm
	terminals M4		1,1	2,0	Nm
Gewicht weight		G		300	g

Mit dieser technischen Information werden Halbleiterbauelemente spezifiziert, jedoch keine Eigenschaften zugesichert. Sie gilt in Verbindung mit den zugehörigen Technischen Erläuterungen.

This technical information specifies semiconductor devices but promises no characteristics. It is valid in combination with the belonging technical notes.



Ausgangskennlinie (typisch)
Output characteristic (typical)

$I_C = f(V_{CE})$
 $V_{GE} = 15V$

vorläufige Daten
preliminary data

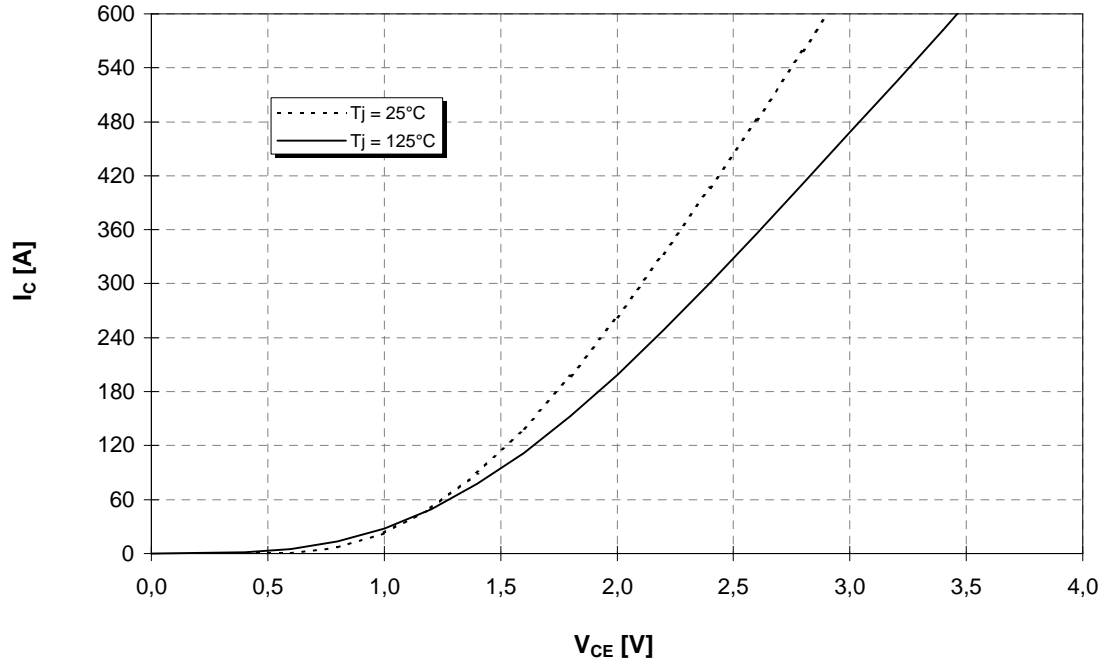

Ausgangskennlinienfeld (typisch)
Output characteristic (typical)

$I_C = f(V_{CE})$
 $T_{vj} = 125^\circ C$

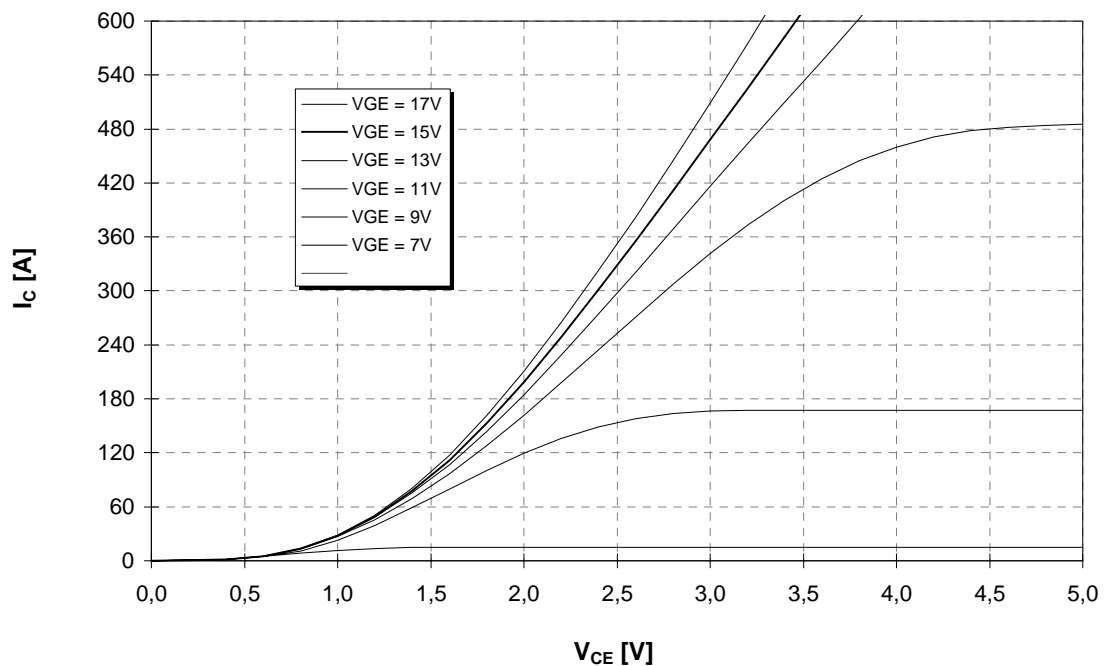

www.DataSheet4U.com



vorläufige Daten
preliminary data

Übertragungscharakteristik (typisch)
Transfer characteristic (typical)

$I_C = f(V_{GE})$
 $V_{CE} = 20V$

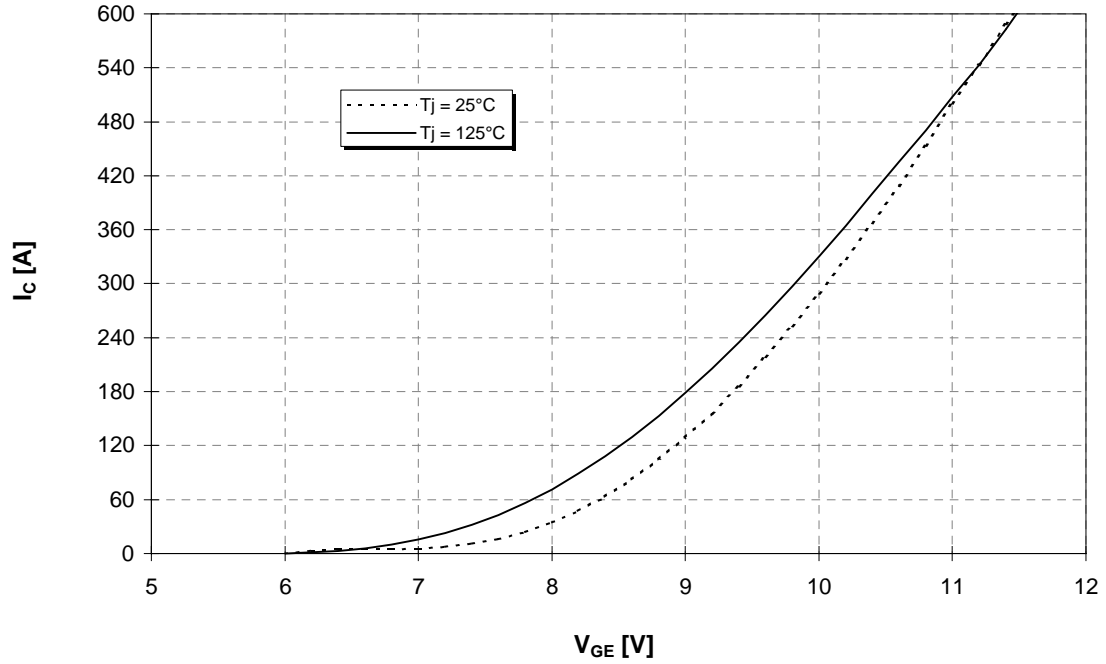

Durchlaßkennlinie der Inversdiode (typisch)
Forward characteristic of inverse diode (typical)

$I_F = f(V_F)$

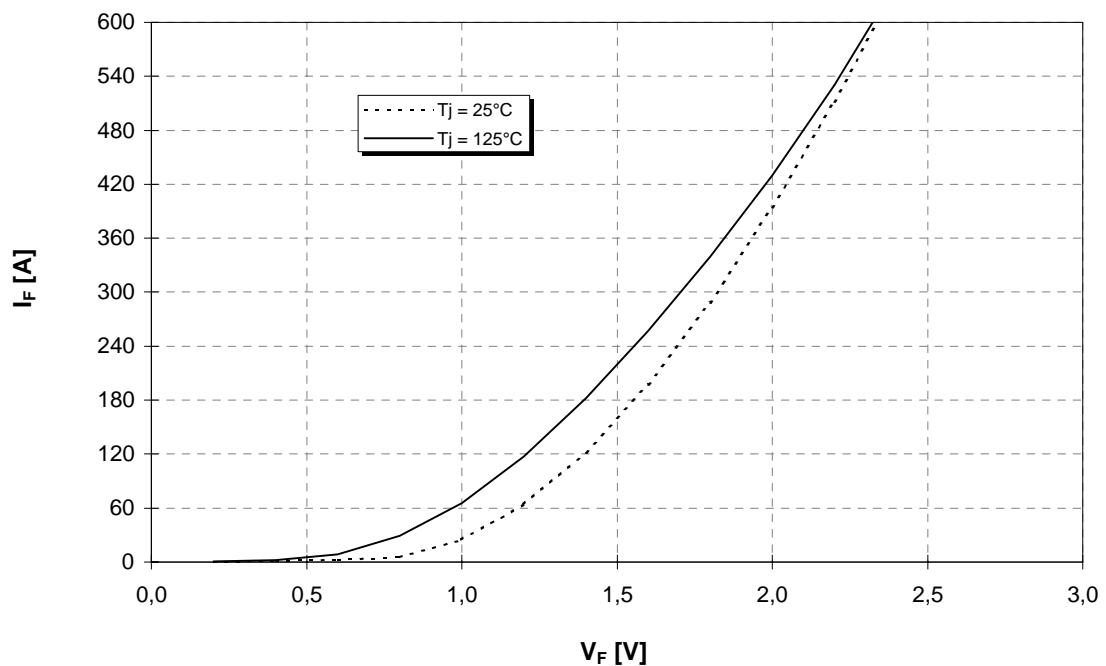



vorläufige Daten
preliminary data

Schaltverluste (typisch) $E_{on} = f(I_C)$, $E_{off} = f(I_C)$, $E_{rec} = f(I_C)$
Switching losses (typical) $V_{GE}=15V$, $R_{gon} = R_{goff} = 3,3 \Omega$, $V_{CE} = 600V$, $T_j = 125^\circ C$

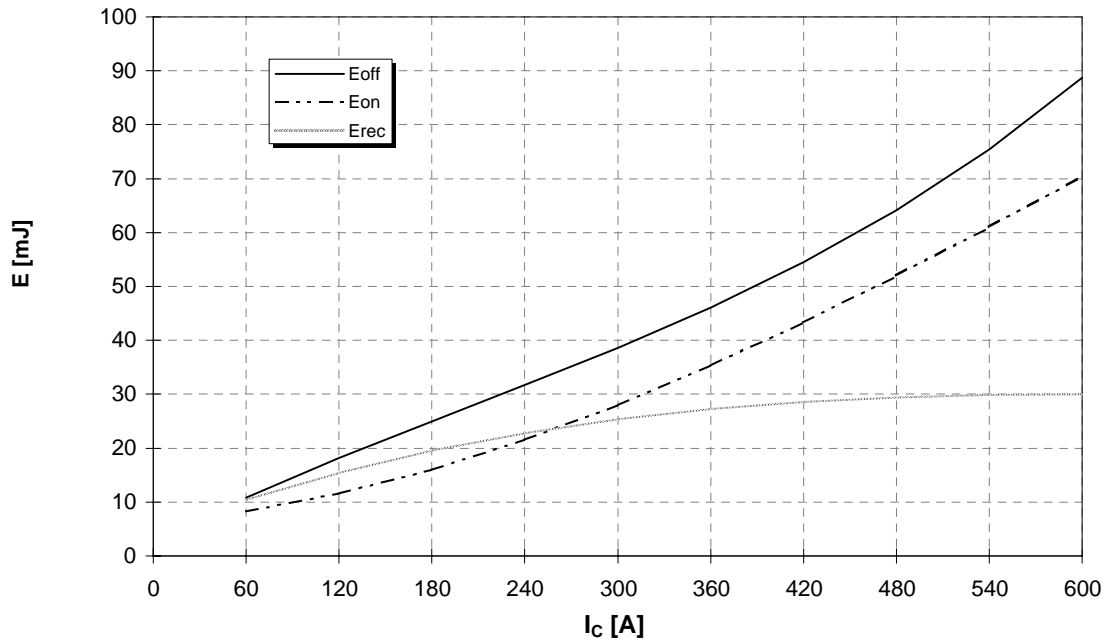

Schaltverluste (typisch) $E_{on} = f(R_G)$, $E_{off} = f(R_G)$, $E_{rec} = f(R_G)$
Switching losses (typical) $V_{GE}=15V$, $I_C = 300A$, $V_{CE} = 600V$, $T_j = 125^\circ C$

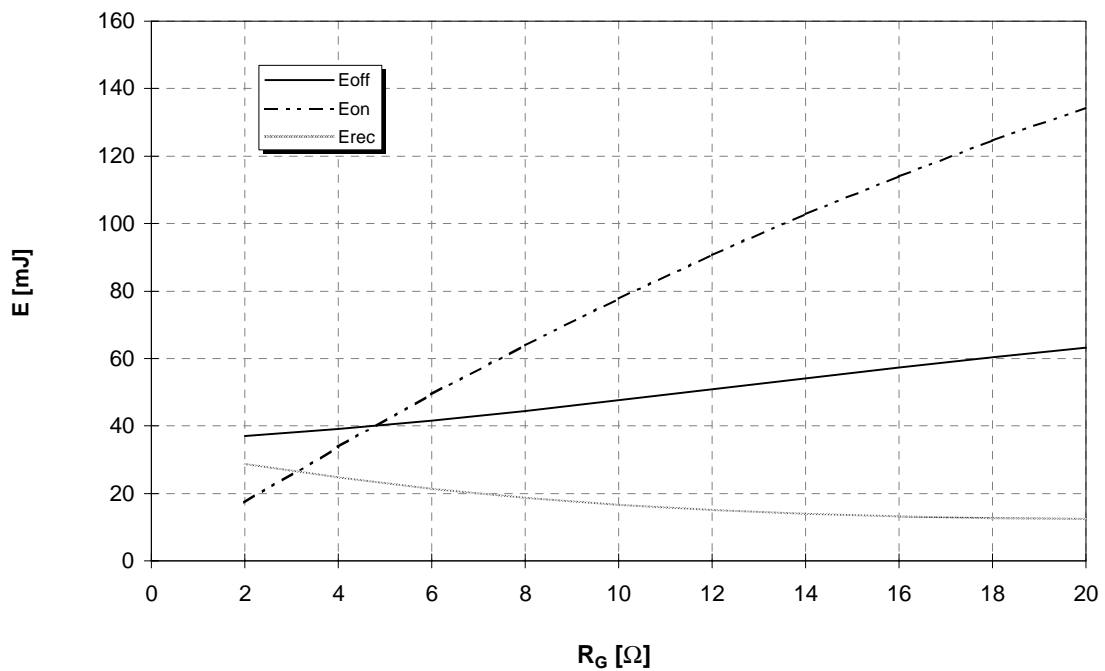

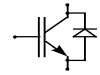

vorläufige Daten

preliminary data

Transienter Wärmewiderstand
Transient thermal impedance

$$Z_{thJC} = f(t)$$

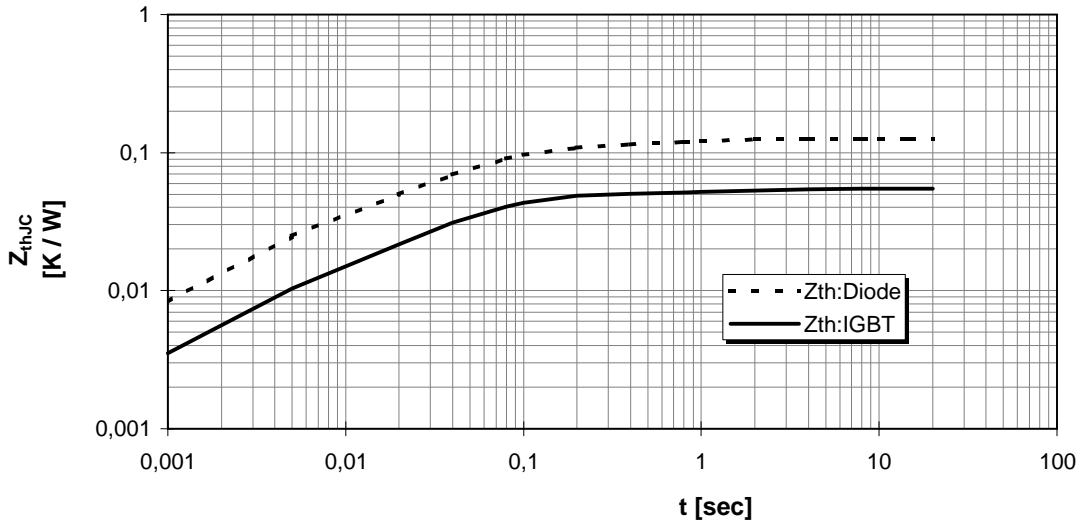

i	1	2	3	4
r_i [K/kW] : IGBT	6,15	18,62	24,26	5,97
τ_i [sec] : IGBT	0,002	0,03	0,066	1,655
r_i [K/kW] : Diode	16,36	43,32	47,27	18,05
τ_i [sec] : Diode	0,002	0,03	0,072	0,682

Sicherer Arbeitsbereich (RBSOA)

Reverse bias safe operation area (RBSOA)

$V_{GE} = 15V, R_g = 3,3 \text{ Ohm}, T_{vj} = 125^\circ C$

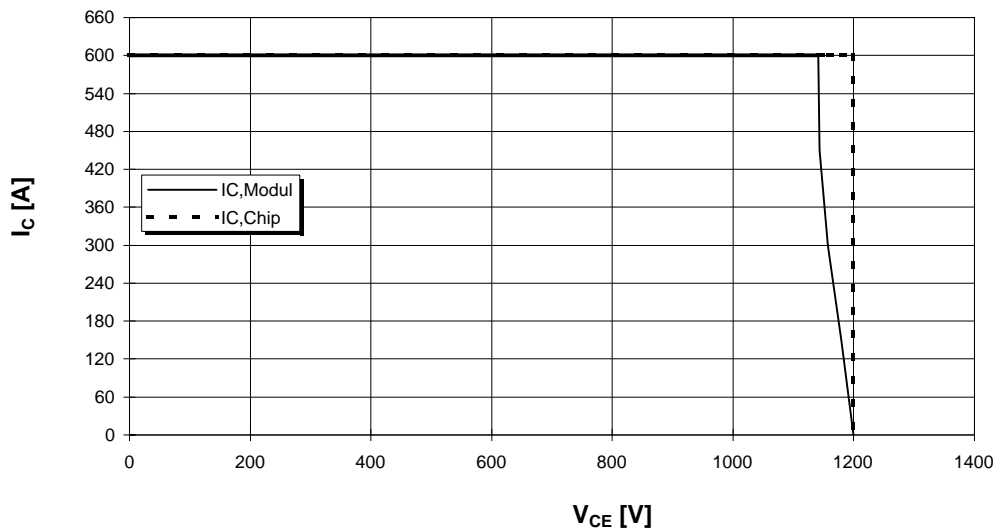

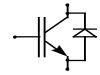

Single Switch 62

vorläufige Daten
preliminary data

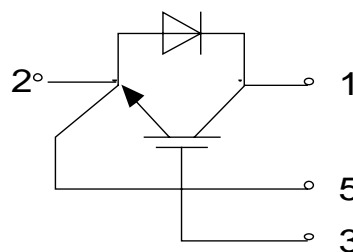
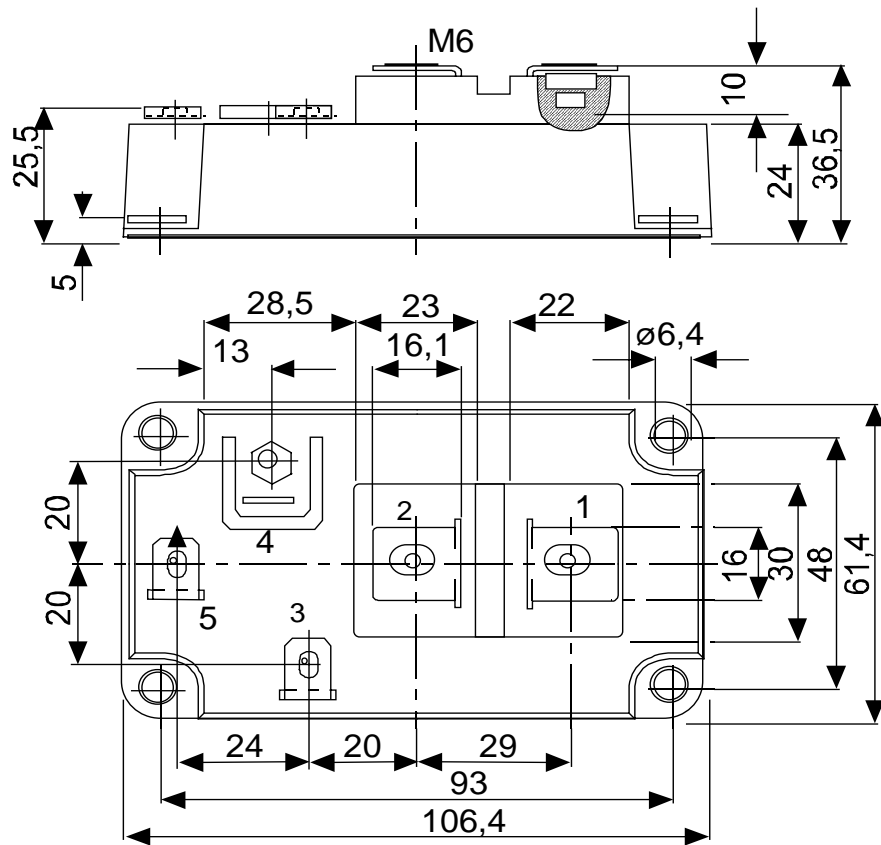

IS6