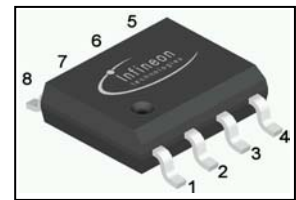

**OptiMOS<sup>®</sup> 2 Power-Transistor**
**Features**

- Fast switching MOSFET for SMPS
- Optimized technology for notebook DC/DC
- Qualified according to JEDEC<sup>1</sup> for target applications
- N-channel
- Logic level
- Excellent gate charge x  $R_{DS(on)}$  product (FOM)
- Very low on-resistance  $R_{DS(on)}$
- Avalanche rated
- $dv/dt$  rated

**Product Summary**

$V_{DS}$	30	V
$R_{DS(on),max}$	6.8	m $\Omega$
$I_D$	15	A

**P-DSO-8**

Type	Package	Ordering Code	Marking
BSO072N03S	P-DSO-8	Q67042-S4208	72N3S

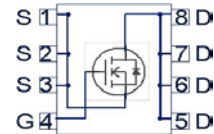
**Maximum ratings, at  $T_j=25\text{ }^\circ\text{C}$ , unless otherwise specified**

Parameter	Symbol	Conditions	Value		Unit
			10 secs	steady state	
Continuous drain current	$I_D$	$T_A=25\text{ }^\circ\text{C}^{(2)}$	15	12	A
		$T_A=70\text{ }^\circ\text{C}^{(2)}$	12	9.6	
Pulsed drain current	$I_{D,pulse}$	$T_A=25\text{ }^\circ\text{C}^{(3)}$	60		
Avalanche energy, single pulse	$E_{AS}$	$I_D=15\text{ A}$ , $R_{GS}=25\text{ }\Omega$	145		mJ
Reverse diode $dv/dt$	$dv/dt$	$I_D=15\text{ A}$ , $V_{DS}=20\text{ V}$ , $di/dt=200\text{ A}/\mu\text{s}$ , $T_{j,max}=150\text{ }^\circ\text{C}$	6		kV/ $\mu\text{s}$
Gate source voltage	$V_{GS}$		$\pm 20$		V
Power dissipation	$P_{tot}$	$T_A=25\text{ }^\circ\text{C}^{(2)}$	2.5	1.56	W
Operating and storage temperature	$T_j$ , $T_{stg}$		-55 ... 150		$^\circ\text{C}$
IEC climatic category; DIN IEC 68-1			55/150/56		

Parameter	Symbol	Conditions	Values			Unit
			min.	typ.	max.	

**Thermal characteristics**

Thermal resistance, junction - soldering point	$R_{thJS}$		-	-	35	K/W
Thermal resistance, junction - ambient	$R_{thJA}$	minimal footprint, $t_p \leq 10$ s	-	-	110	
		minimal footprint, steady state	-	-	150	
		6 cm <sup>2</sup> cooling area <sup>2)</sup> , $t_p \leq 10$ s	-	-	50	
		6 cm <sup>2</sup> cooling area <sup>2)</sup> , steady state	-	-	80	

**Electrical characteristics, at  $T_j=25$  °C, unless otherwise specified**
**Static characteristics**

Drain-source breakdown voltage	$V_{(BR)DSS}$	$V_{GS}=0$ V, $I_D=1$ mA	30	-	-	V
Gate threshold voltage	$V_{GS(th)}$	$V_{DS}=V_{GS}$ , $I_D=45$ $\mu$ A	1.2	1.6	2	
Zero gate voltage drain current	$I_{DSS}$	$V_{DS}=30$ V, $V_{GS}=0$ V, $T_j=25$ °C	-	0.1	1	$\mu$ A
		$V_{DS}=30$ V, $V_{GS}=0$ V, $T_j=125$ °C	-	10	100	
Gate-source leakage current	$I_{GSS}$	$V_{GS}=20$ V, $V_{DS}=0$ V	-	10	100	nA
Drain-source on-state resistance	$R_{DS(on)}$	$V_{GS}=4.5$ V, $I_D=13$ A	-	7.4	9.3	m $\Omega$
		$V_{GS}=10$ V, $I_D=15$ A	-	5.7	6.8	
Gate resistance	$R_G$		-	1	-	$\Omega$
Transconductance	$g_{fs}$	$ V_{DS}  > 2 I_D R_{DS(on)max}$ , $I_D=15$ A	24	47	-	S

<sup>1)</sup>J-STD20 and JESD22

<sup>2)</sup> Device on 40 mm x 40 mm x 1.5 mm epoxy PCB FR4 with 6 cm<sup>2</sup> (one layer, 70  $\mu$ m thick) copper area for drain connection. PCB is vertical in still air.

<sup>3)</sup> See figure 3

Parameter	Symbol	Conditions	Values			Unit
			min.	typ.	max.	

**Dynamic characteristics**

Input capacitance	$C_{iss}$	$V_{GS}=0\text{ V}, V_{DS}=15\text{ V}, f=1\text{ MHz}$	-	2430	3230	pF
Output capacitance	$C_{oss}$		-	865	1150	
Reverse transfer capacitance	$C_{rss}$		-	110	160	
Turn-on delay time	$t_{d(on)}$	$V_{DD}=15\text{ V}, V_{GS}=10\text{ V}, I_D=7.5\text{ A}, R_G=2.7\ \Omega$	-	6.5	10	ns
Rise time	$t_r$		-	5.4	8.1	
Turn-off delay time	$t_{d(off)}$		-	27	40	
Fall time	$t_f$		-	4.0	6.0	

**Gate Charge Characteristics<sup>4)</sup>**

Gate to source charge	$Q_{gs}$	$V_{DD}=15\text{ V}, I_D=7.5\text{ A}, V_{GS}=0\text{ to }5\text{ V}$	-	6.6	8.8	nC
Gate charge at threshold	$Q_{g(th)}$		-	3.9	5.2	
Gate to drain charge	$Q_{gd}$		-	4.5	6.7	
Switching charge	$Q_{sw}$		-	7.2	10	
Gate charge total	$Q_g$		-	19	25	
Gate plateau voltage	$V_{plateau}$		-	2.7	-	
Gate charge total, sync. FET	$Q_{g(sync)}$	$V_{DS}=0.1\text{ V}, V_{GS}=0\text{ to }5\text{ V}$	-	16	22	nC
Output charge	$Q_{oss}$	$V_{DD}=15\text{ V}, V_{GS}=0\text{ V}$	-	21	27	

**Reverse Diode**

Diode continuous forward current	$I_S$	$T_A=25\text{ }^\circ\text{C}$	-	-	2.5	A
Diode pulse current	$I_{S,pulse}$		-	-	60	
Diode forward voltage	$V_{SD}$	$V_{GS}=0\text{ V}, I_F=2.5\text{ A}, T_j=25\text{ }^\circ\text{C}$	-	0.73	1	V
Reverse recovery charge	$Q_{rr}$	$V_R=15\text{ V}, I_F=I_S, di_F/dt=400\text{ A}/\mu\text{s}$	-	-	10	nC

<sup>4)</sup> See figure 16 for gate charge parameter definition

**1 Power dissipation**

$P_{tot}=f(T_A); t_p \leq 10 \text{ s}$

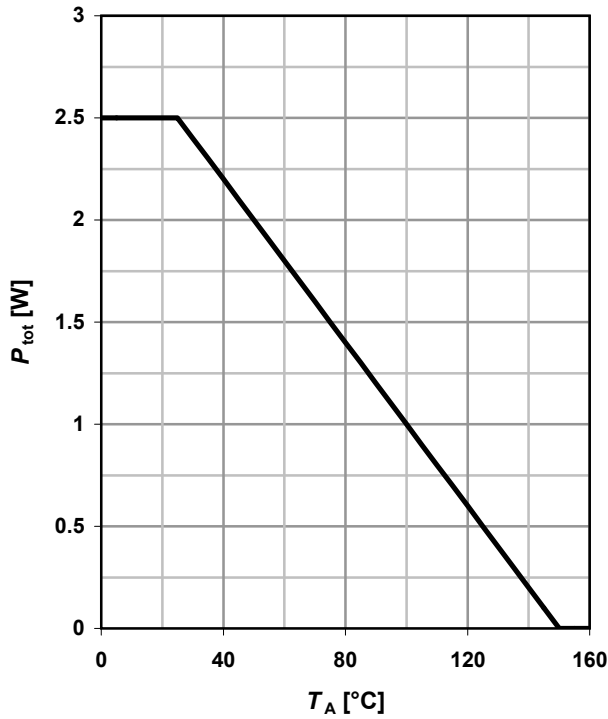

**2 Drain current**

$I_D=f(T_A); V_{GS} \geq 10 \text{ V}; t_p \leq 10 \text{ s}$

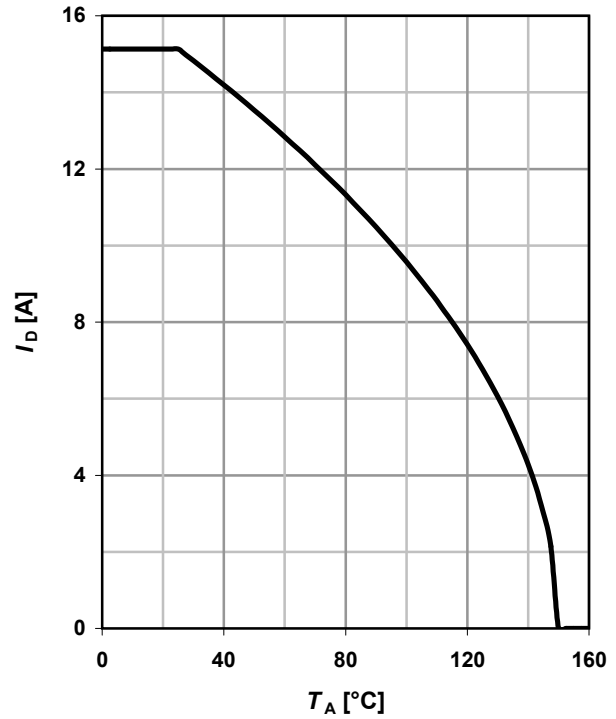

**3 Safe operation area**

$I_D=f(V_{DS}); T_A=25 \text{ }^\circ\text{C}^1; D=0$

parameter:  $t_p$

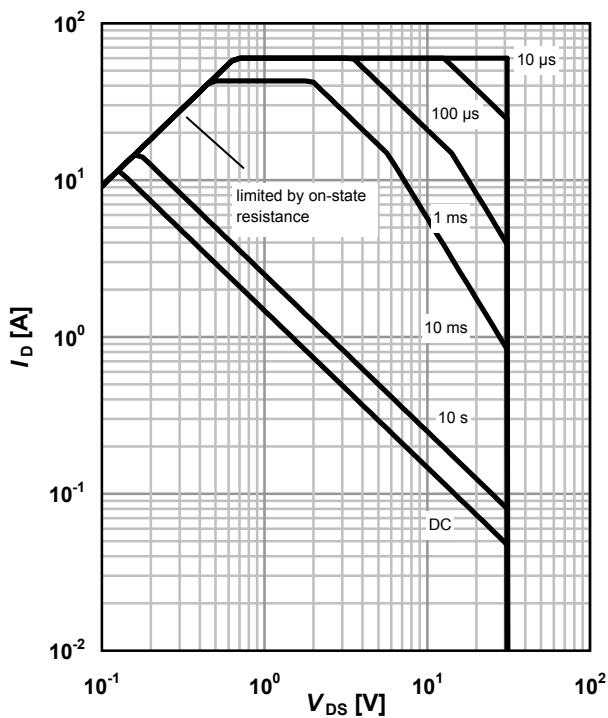

**4 Max. transient thermal impedance**

$Z_{thJS}=f(t_p)$

parameter:  $D=t_p/T$

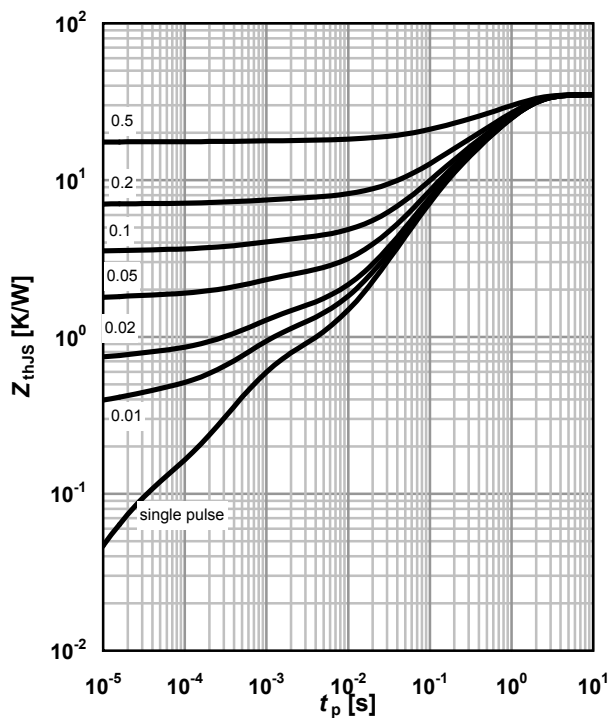

**5 Typ. output characteristics**

$I_D = f(V_{DS}); T_j = 25\text{ }^\circ\text{C}$

parameter:  $V_{GS}$

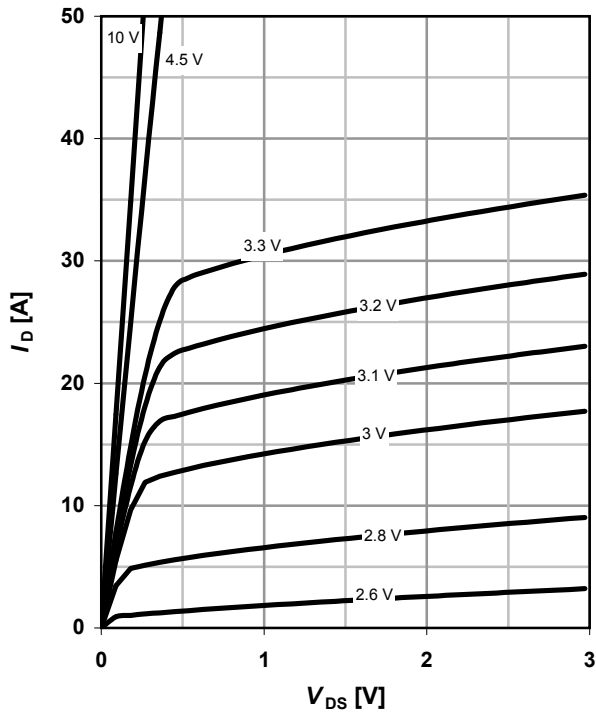

**6 Typ. drain-source on resistance**

$R_{DS(on)} = f(I_D); T_j = 25\text{ }^\circ\text{C}$

parameter:  $V_{GS}$

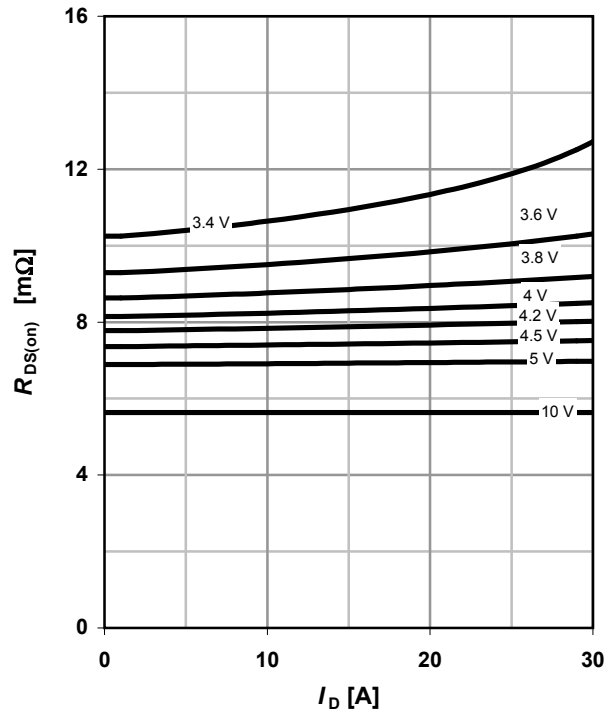

**7 Typ. transfer characteristics**

$I_D = f(V_{GS}); |V_{DS}| > 2|I_D|R_{DS(on)max}$

parameter:  $T_j$

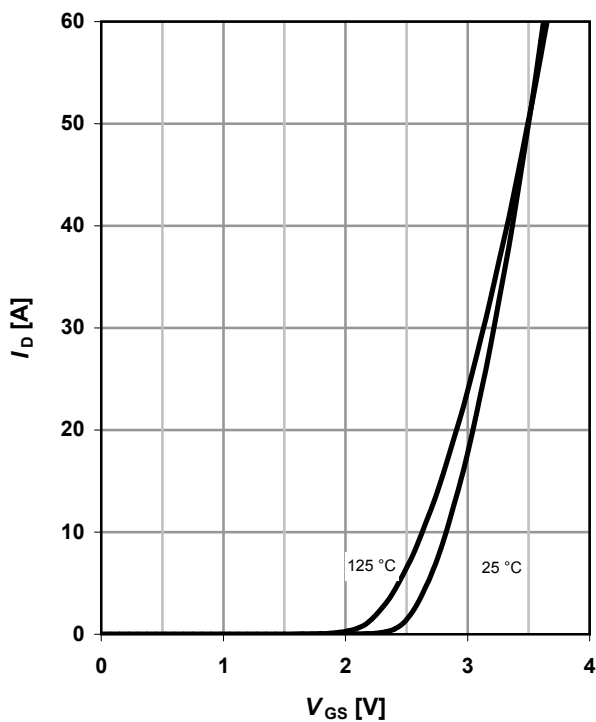

**8 Typ. forward transconductance**

$g_{fs} = f(I_D); T_j = 25\text{ }^\circ\text{C}$

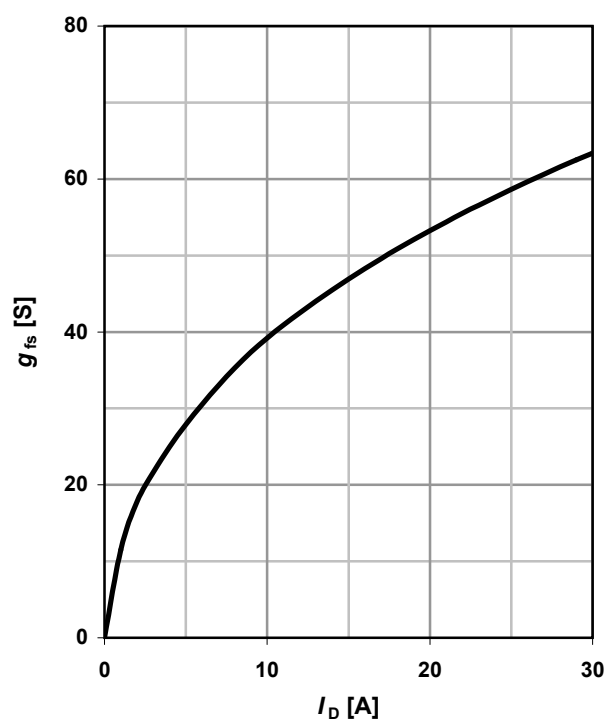

**9 Drain-source on-state resistance**

$R_{DS(on)} = f(T_j); I_D = 15 \text{ A}; V_{GS} = 10 \text{ V}$

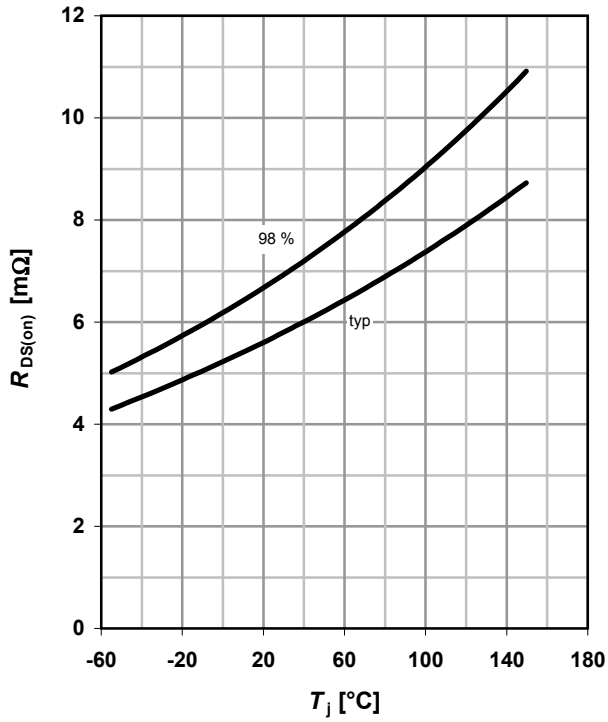

**10 Typ. gate threshold voltage**

$V_{GS(th)} = f(T_j); V_{GS} = V_{DS}$

parameter:  $I_D$

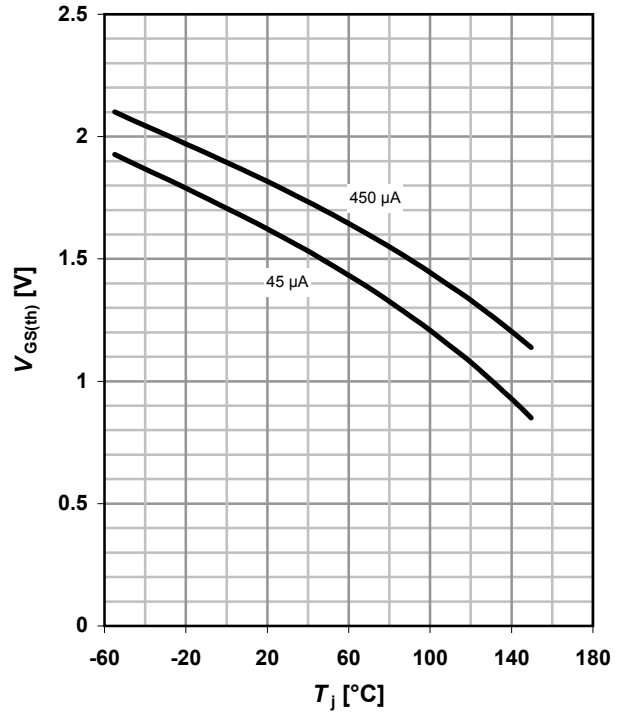

**11 Typ. capacitances**

$C = f(V_{DS}); V_{GS} = 0 \text{ V}; f = 1 \text{ MHz}$

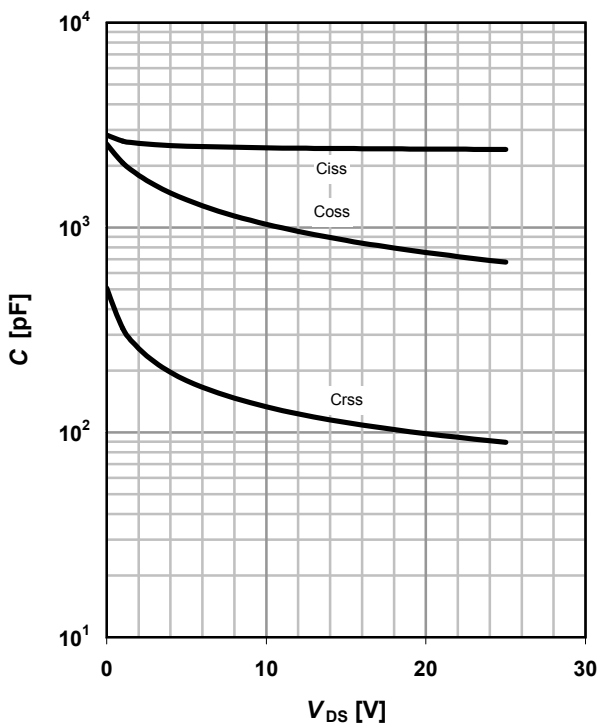

**12 Forward characteristics of reverse diode**

$I_F = f(V_{SD})$

parameter:  $T_j$

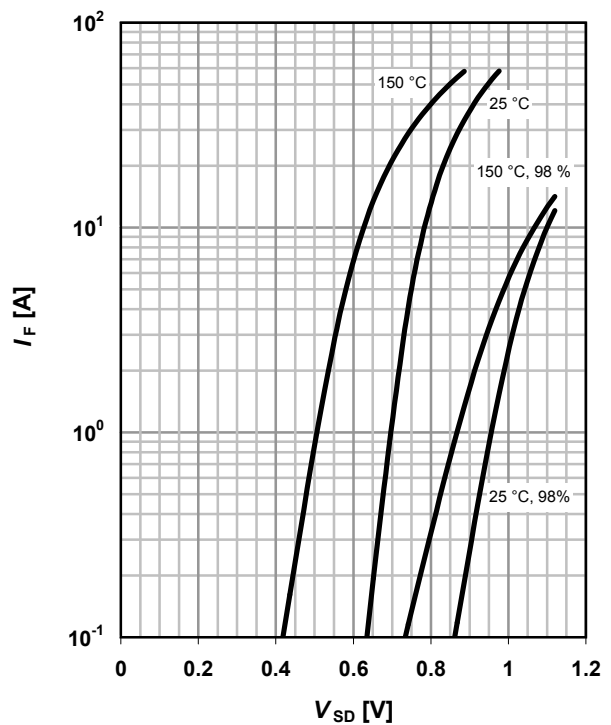

**13 Avalanche characteristics**

$I_{AS}=f(t_{AV}); R_{GS}=25 \Omega$

parameter:  $T_{j(start)}$

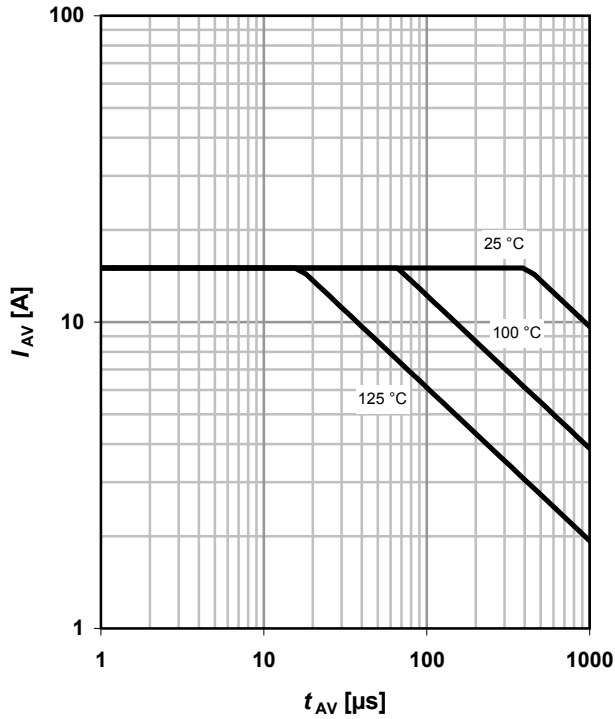

**14 Typ. gate charge**

$V_{GS}=f(Q_{gate}); I_D=7.5 \text{ A pulsed}$

parameter:  $V_{DD}$

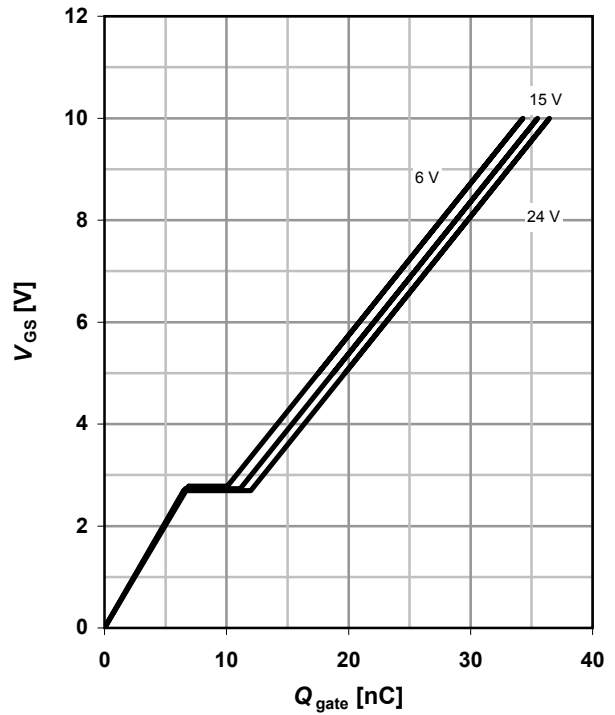

**15 Drain-source breakdown voltage**

$V_{BR(DSS)}=f(T_j); I_D=1 \text{ mA}$

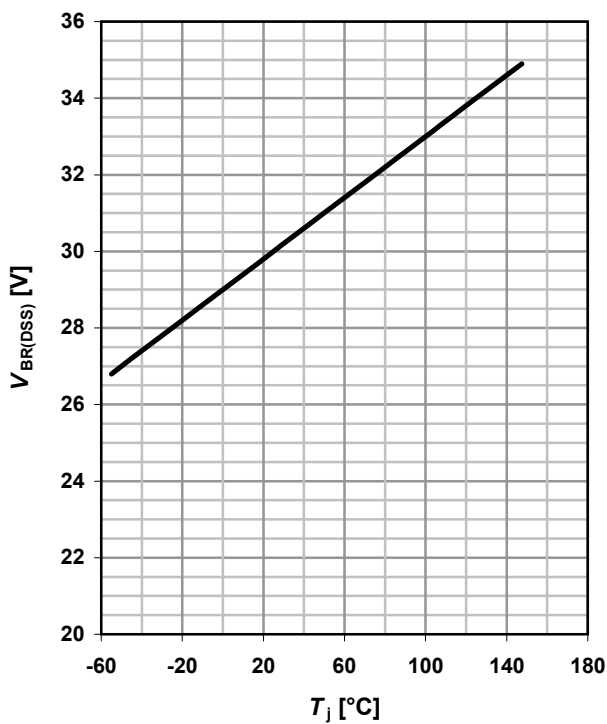

**16 Gate charge waveforms**

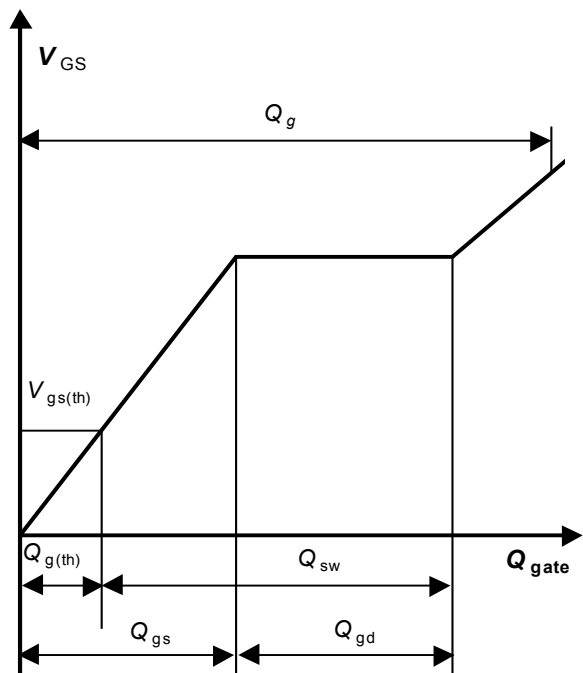

Package Outline

P-DSO-8: Outline

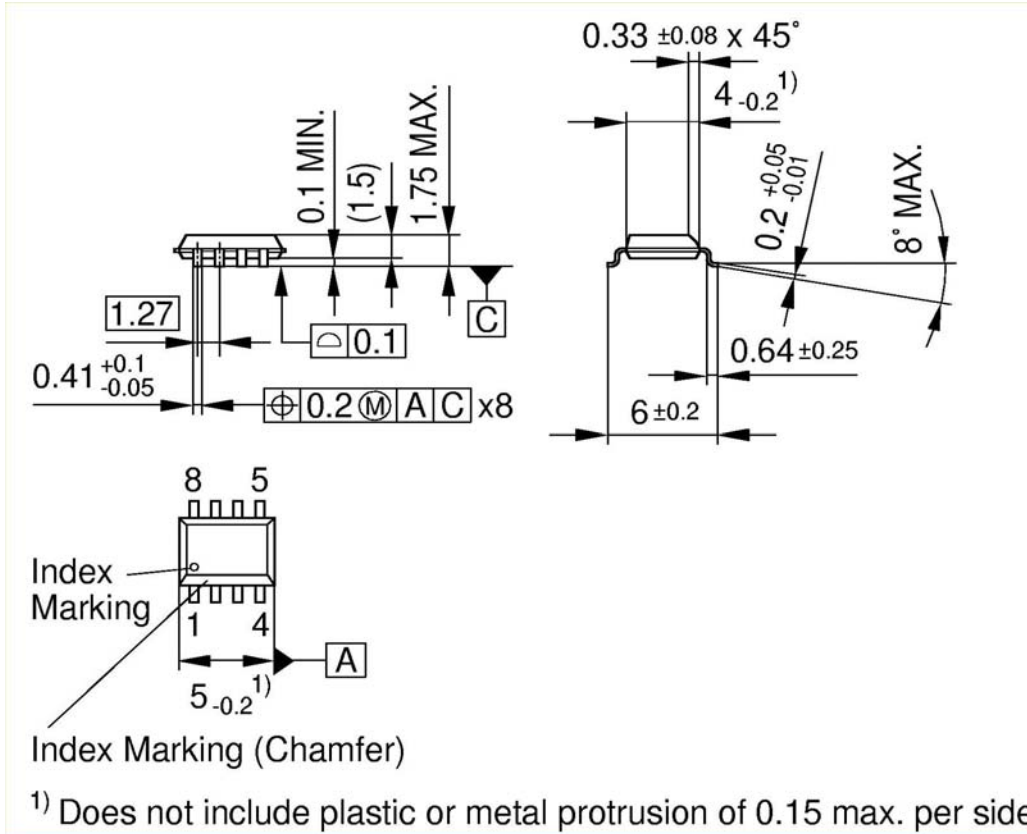

Footprint

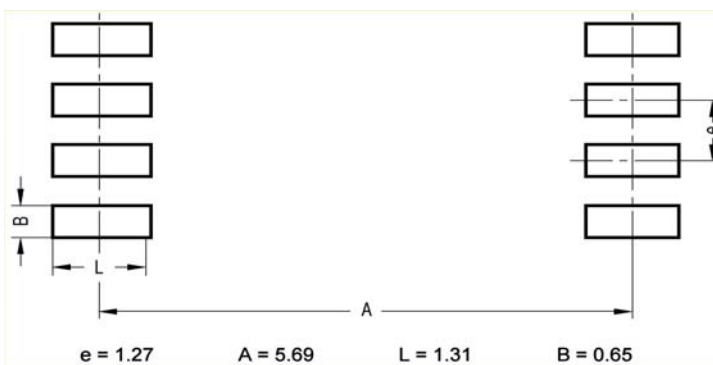

Packaging

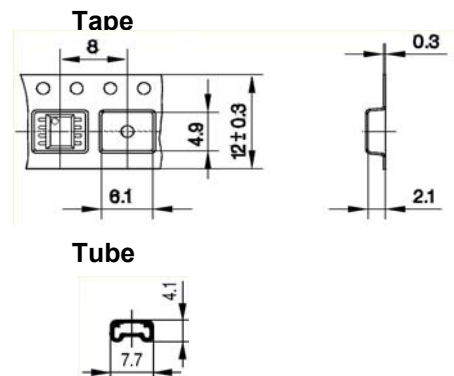

Dimensions in mm



**Published by**  
**Infineon Technologies AG**  
**Bereich Kommunikation**  
**St.-Martin-Straße 53**  
**D-81541 München**  
**© Infineon Technologies AG 1999**  
**All Rights Reserved.**

**Attention please!**

The information herein is given to describe certain components and shall not be considered as warranted characteristics.

Terms of delivery and rights to technical change reserved.

We hereby disclaim any and all warranties, including but not limited to warranties of non-infringement, regarding circuits, descriptions and charts started herein.

Infineon Technologies is an approved CECC manufacturer.

**Information**

For further information on technology, delivery terms and conditions and prices, please contact your nearest Infineon Technologies office in Germany or our Infineon Technologies representatives worldwide (see address list).

**Warnings**

Due to technical requirements, components may contain dangerous substances.  
For information on the types in question, please contact your nearest Infineon Technologies office.

Infineon Technologies' components may only be used in life-support devices or systems with the expressed written approval of Infineon Technologies if a failure of such components can reasonably be expected to cause the failure of that life-support device or system, or to affect the safety or effectiveness of that device or system. Life support devices or systems are intended to be implanted in the human body, or to support and/or maintain and sustain and/or protect human life. If they fail, it is reasonable to assume that the health of the user or other persons may be endangered.