

PNP Silicon Planar Transistors

BSV 15
BSV 16
BSV 17

SIEMENS AKTIENGESELLSCHAFT

BSV 15, BSV 16 and BSV 17 are epitaxial PNP silicon planar transistors in TO 39 case (5 C 3 DIN 41873). The collector is electrically connected to the case. The transistors are particularly suitable for use in AF amplifiers and for AF switching applications.

Type	Ordering code
BSV 15 ¹⁾	Q62702-S425
BSV 15-6	Q62702-S207
BSV 15-10	Q62702-S208
BSV 15-16	Q62702-S209
BSV 16 ¹⁾	Q62702-S426
BSV 16-6	Q62702-S210
BSV 16-10	Q62702-S211
BSV 16-16	Q62702-S212
BSV 17 ¹⁾	Q62702-S427
BSV 17-6	Q62702-S213
BSV 17-10	Q62702-S214

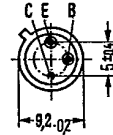
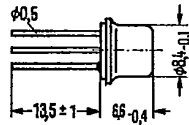

Approx. weight 1.5 g

Dimensions in mm

Maximum ratings

	BSV 15	BSV 16	BSV 17		
Collector-emitter voltage	-V _{CEO}	40	60	80	V
Collector-emitter voltage	-V _{CES}	40	60	80	V
Emitter-base voltage	-V _{EBO}	5	5	5	V
Collector current	-I _C	1	1	1	A
Base current	-I _B	0.2	0.2	0.2	A
Junction temperature	T _j	200	200	200	°C
Storage temperature range	T _{stg}	-65 to +200			°C
Total power dissipation (T _{case} ≤ 25 °C)	P _{tot}	5	5	5	W

Thermal resistance

Junction to ambient air	R _{thJA}	≤ 200	≤ 200	≤ 200	K/W
Junction to case	R _{thJC}	≤ 35	≤ 35	≤ 35	K/W

1) In case of orders without an exact indication of the current amplification wanted, a transistor will be delivered of that current amplification group available at stock.

SIEMENS AKTIENGESELLSCHAFT

Static characteristics ($T_{amb} = 25^{\circ}\text{C}$)

The transistors BSV 15, BSV 16 and BSV 17 are grouped according to the DC current gain at $-I_C = 100\text{ mA}$ and marked with figures of the DIN R 5 standard series. At a voltage of $V_{CE} = 1\text{ V}$ the following values apply:

Type	BSV 15 BSV 16 BSV 17	BSV 15 BSV 16 BSV 17	BSV 15 BSV 16	BSV 15 BSV 16 BSV 17
h_{FE} group	6	10	16	
I_C mA	h_{FE} I_C/I_B	h_{FE} I_C/I_B	h_{FE} I_C/I_B	V_{BE} V
0.1	44 (>15)	75 (>20)	120 (>30)	-
100	63 (40 to 100)	100 (63 to 160)	160 (100 to 250)	<1
500	40 (>20)	55 (>25)	85 (>35)	0.85 (0.7 to 1.4)

Static characteristics ($T_{amb} = 25^{\circ}\text{C}$)

	BSV 15	BSV 16	BSV 17		
Collector-emitter saturation voltage ($-I_C = 500\text{ mA}$; $I_B = 25\text{ mA}$)	$-V_{CEsat}$	<1	<1	<1	V
Collector cutoff current ($-V_{CE} = 40\text{ V}$)	$-I_{CES}$	<100	-	-	nA
Collector cutoff current ($-V_{CE} = 40\text{ V}$; $T_{amb} = 150^{\circ}\text{C}$)	$-I_{CES}$	<50	-	-	μA
Collector cutoff current ($-V_{CE} = 60\text{ V}$)	$-I_{CES}$	-	<100	-	nA
Collector cutoff current ($-V_{CE} = 60\text{ V}$; $T_{amb} = 150^{\circ}\text{C}$)	$-I_{CES}$	-	<50	-	μA
Collector cutoff current ($-V_{CE} = 80\text{ V}$)	$-I_{CES}$	-	-	<100	nA
Collector cutoff current ($-V_{CE} = 80\text{ V}$; $T_{amb} = 150^{\circ}\text{C}$)	$-I_{CES}$	-	-	<50	μA
Emitter cutoff current ($-V_{EB} = 4\text{ V}$)	$-I_{EBO}$	<50	<50	<50	nA
Collector cutoff current ($-V_{CE} = 40\text{ V}$; $-V_{BE} = 0.2\text{ V}$; $T_{amb} = 100^{\circ}\text{C}$)	$-I_{CEX}$	<50	-	-	μA
Collector cutoff current ($-V_{CE} = 60\text{ V}$; $-V_{BE} = 0.2\text{ V}$; $T_{amb} = 100^{\circ}\text{C}$)	$-I_{CEX}$	-	<50	-	μA
Collector cutoff current ($-V_{CE} = 80\text{ V}$; $-V_{BE} = 0.2\text{ V}$; $T_{amb} = 100^{\circ}\text{C}$)	I_{CEX}	-	-	<50	μA
Collector-emitter reverse voltage ($-I_{CE} = 50\text{ mA}$; $v = 200\text{ }\mu\text{s}$; 1%)	$-V_{CEO}$	>40	>60	>80	V
Collector-emitter voltage ($-I_{CE} = 10\text{ }\mu\text{A}$)	$-V_{CES}$	>40	>60	>90	V
Emitter-base reverse voltage ($-I_{EBO} = 10\text{ }\mu\text{A}$)	$-V_{EBO}$	>5	>5	>5	V

SIEMENS AKTIENGESELLSCHAFT

Dynamic characteristics ($T_{amb} = 25^{\circ}C$)

		BSV 15 BSV 16	BSV 17	
Transition frequency ($I_C = 50\text{ mA}$; $V_{CE} = 10\text{ V}$, $f = 20\text{ MHz}$)	f_T	> 50	> 50	MHz
Collector-base capacitance ($V_{CBO} = 10\text{ V}$; $I_E = 0$; $f = 1\text{ MHz}$)	C_{CBO}	20 (<30)	15 (<25)	pF
Emitter-base capacitance ($V_{EBO} = 0.5\text{ V}$; $I_C = 0$; $f = 1\text{ MHz}$)	C_{EBO}	180	180	pF
Small-signal current gain ($I_C = 1\text{ mA}$; $V_{CE} = 5\text{ V}$; $f = 1\text{ kHz}$)	h_{fe}	> 20	> 20	-
Switching times:				
Turn-on time ($I_C = 100\text{ mA}$; I_{B1} approx. $-I_{B2}$ approx. 5 mA) t_{on}		< 500	< 500	ns
Storage time ($I_C = 100\text{ mA}$; I_{B1} approx. $-I_{B2}$ approx. 5 mA) t_s		< 500	< 500	ns
Fall time ($I_C = 100\text{ mA}$; I_{B1} approx. $-I_{B2}$ approx. 5 mA) t_f		< 150	< 150	ns

- SIEMENS AKTIENGESELLSCHAFT

Test circuit for switching times
Test circuit for $I_C = 100 \text{ mA}$

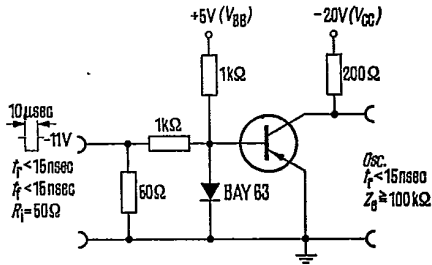

Total perm. power dissipation
versus temperature
 $P_{tot} = f(T); V_{CE} = \text{parameter}$

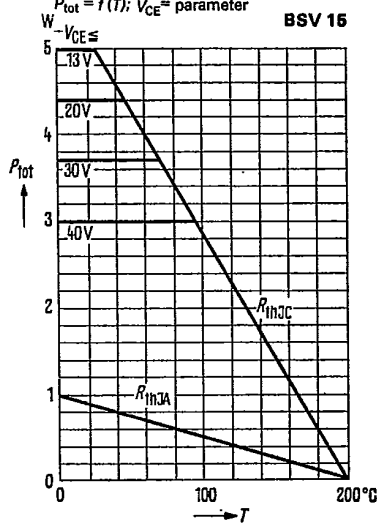

Total perm. power dissipation
versus temperature
 $P_{tot} = f(T); V_{CE} = \text{parameter}$

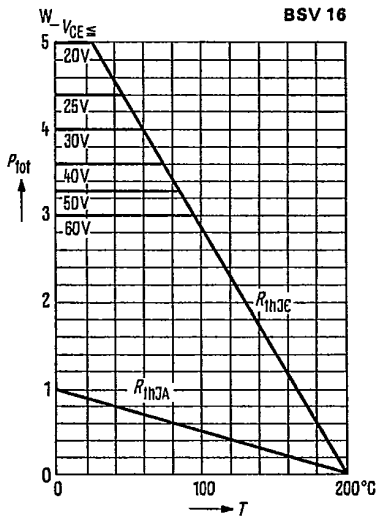

Total perm. power dissipation
versus temperature
 $P_{tot} = f(T); V_{CE} = \text{parameter}$

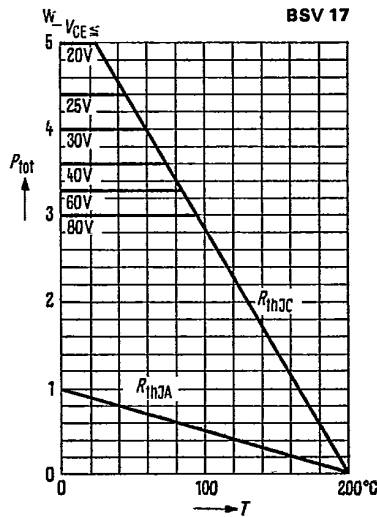

— SIEMENS AKTIENGESELLSCHAFT —

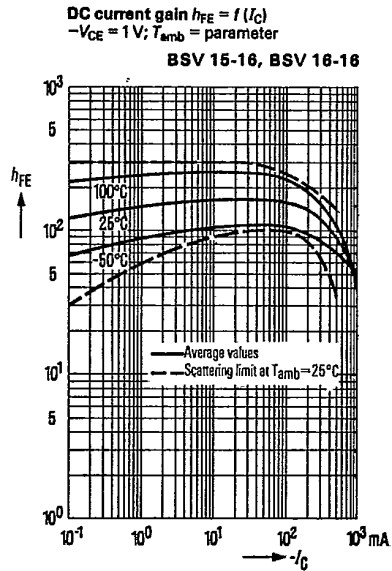
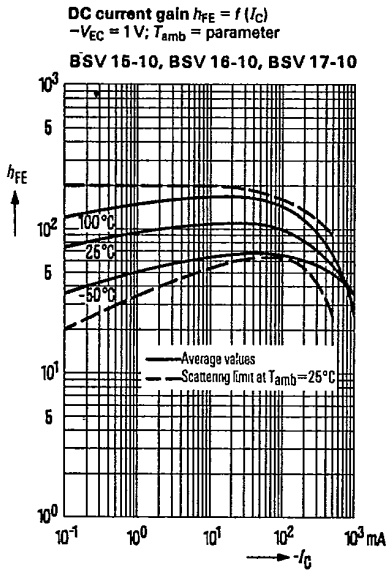
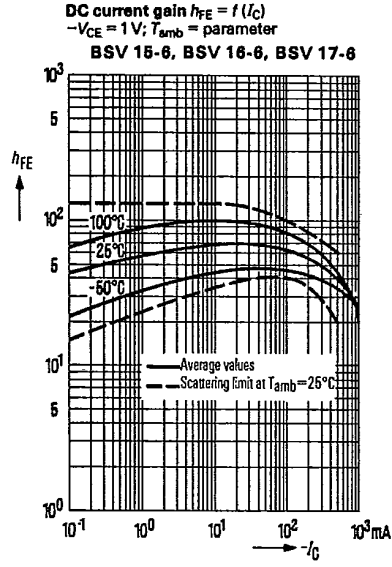
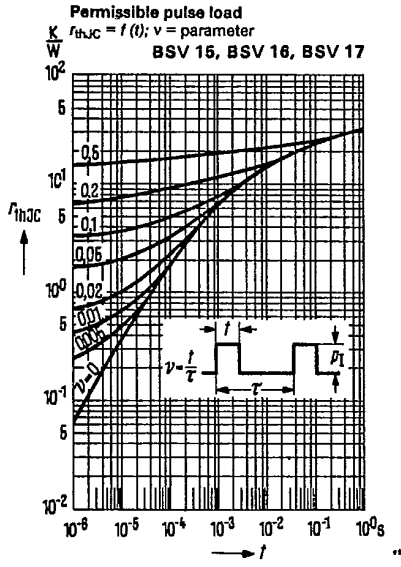

SIEMENS AKTIENGESELLSCHAFT

Permissible operating range
 $I_C = f(V_{CE}); T_{case} = 60^\circ C$

BSV 15

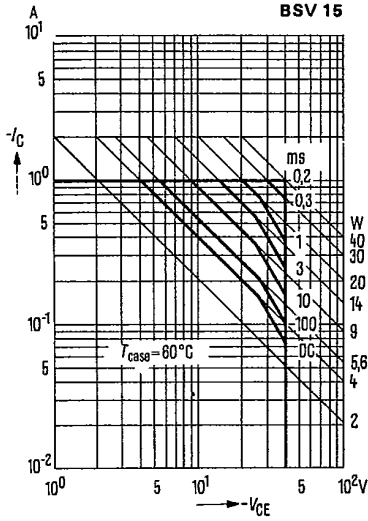

Permissible operating range
 $I_C = f(V_{CE}); T_{case} = 125^\circ C$

BSV 15

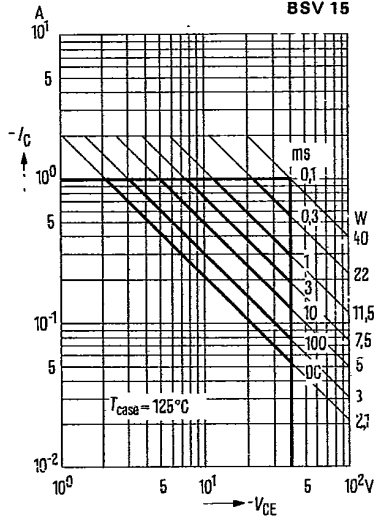

Permissible operating range
 $I_C = f(V_{CE}); T_{case} = 60^\circ C$

BSV 16

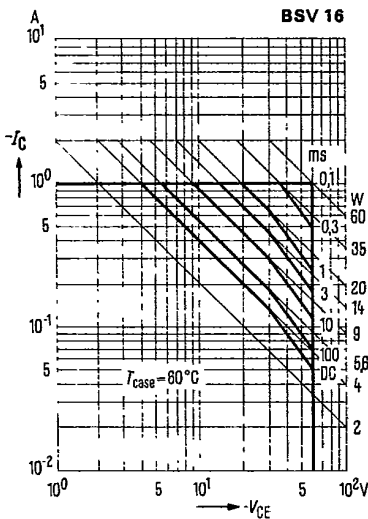

Permissible operating range
 $I_C = f(V_{CE}); T_{case} = 125^\circ C$

BSV 16

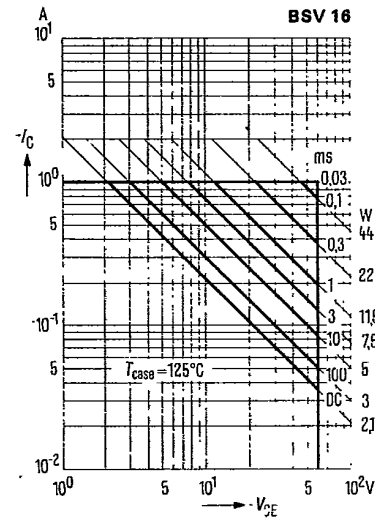

The permissible operating ranges apply to single pulses ($v = 0$). For pulse sequences the power dissipation has to be reduced in accordance with the diagram "permissible pulse load".

SIEMENS AKTIENGESELLSCHAFT

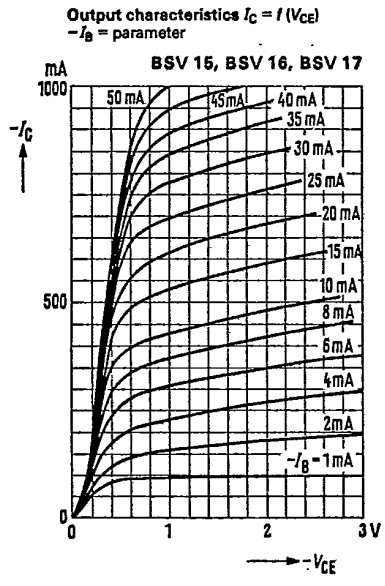
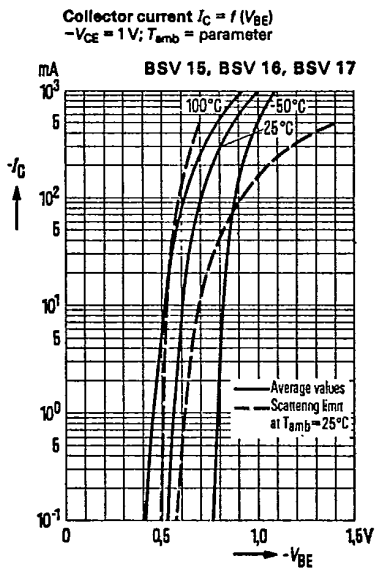
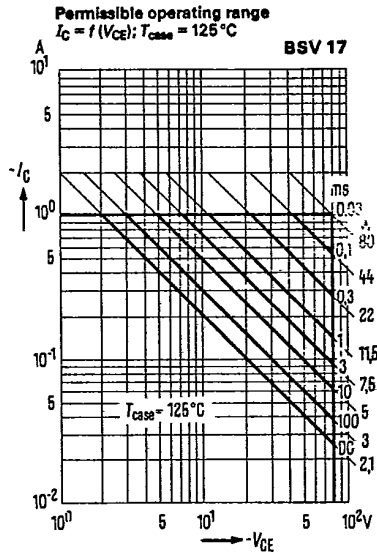
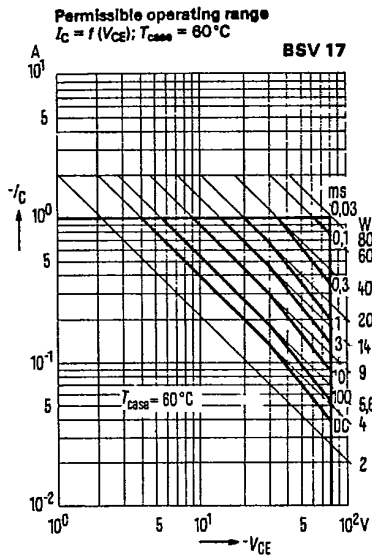

SIEMENS AKTIENGESELLSCHAFT

Collector-emitter saturation voltage

$-V_{CEsat} = f(I_C)$
 $h_{FE} = 20, T_{amb} = \text{parameter}$

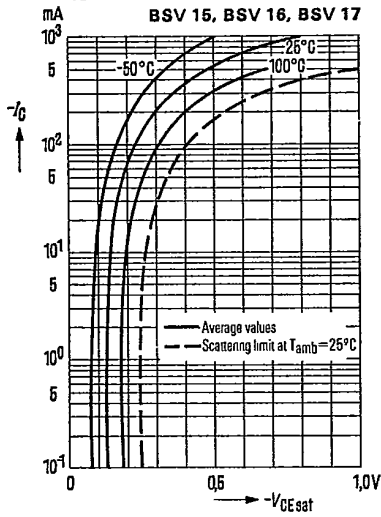

Base-emitter saturation voltage

$-V_{BEsat} = f(I_C)$
 $h_{FE} = 20; T_{amb} = \text{parameter}$

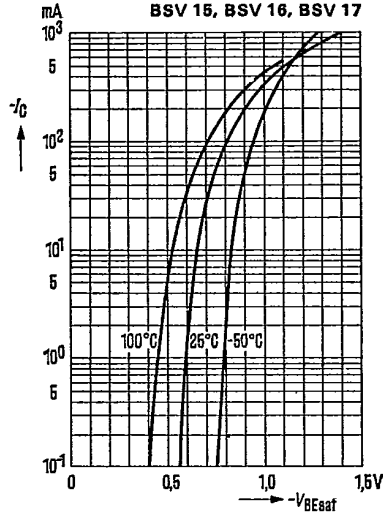

Collector cutoff current versus temperature

$I_{CBO} = f(T_{amb})$
 $-V_{CB} = 40\text{ V}$ BSV 15
 $-V_{CB} = 60\text{ V}$ BSV 16
 $-V_{CB} = 80\text{ V}$ BSV 17

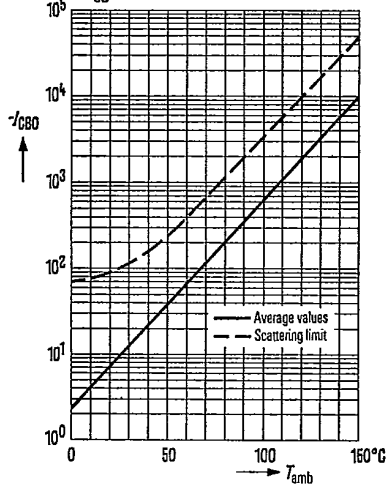

Transition frequency $f_T = f(I_C)$

$-V_{CE} \leq 10\text{ V}$ (Average value)

