

Triacs

BT136X series

GENERAL DESCRIPTION

Glass passivated triacs in a full pack plastic envelope, intended for use in applications requiring high bidirectional transient and blocking voltage capability and high thermal cycling performance. Typical applications include motor control, industrial and domestic lighting, heating and static switching.

QUICK REFERENCE DATA

| SYMBOL | PARAMETER | MAX. | MAX. | MAX. | UNIT |
|--------------|--------------------------------------|------|------|------|------|
| V_{DRM} | Repetitive peak off-state voltages | 500 | 600 | 800 | V |
| | | 500F | 600F | 800F | |
| | | 500G | 600G | 800G | |
| $I_{T(RMS)}$ | RMS on-state current | 4 | 4 | 4 | A |
| I_{TSM} | Non-repetitive peak on-state current | 25 | 25 | 25 | A |

PINNING - SOT186A

| PIN | DESCRIPTION |
|------|-----------------|
| 1 | main terminal 1 |
| 2 | main terminal 2 |
| 3 | gate |
| case | isolated |

PIN CONFIGURATION

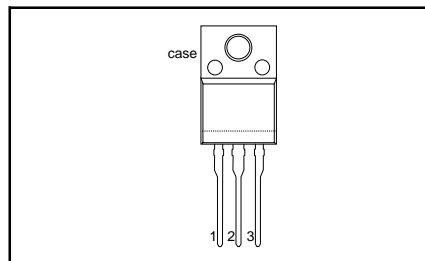

SYMBOL



LIMITING VALUES

Limiting values in accordance with the Absolute Maximum System (IEC 134).

| SYMBOL | PARAMETER | CONDITIONS | MIN. | MAX. | | | UNIT |
|--------------|--|---|------|------------------|------------------|------|------------------|
| | | | | -500 | -600 | -800 | |
| V_{DRM} | Repetitive peak off-state voltages | | - | 500 ¹ | 600 ¹ | 800 | V |
| $I_{T(RMS)}$ | RMS on-state current | full sine wave; $T_{hs} \leq 92^\circ C$ | - | 4 | | | A |
| I_{TSM} | Non-repetitive peak on-state current | full sine wave; $T_j = 25^\circ C$ prior to surge | - | 25 | | | A |
| | | $t = 20\text{ ms}$ | - | 27 | | | A |
| | | $t = 16.7\text{ ms}$ | - | 3.1 | | | A ² s |
| | | $t = 10\text{ ms}$ | - | | | | |
| I^2t | I^2t for fusing | $I_{TM} = 6\text{ A}; I_G = 0.2\text{ A};$ | | | | | |
| dl_T/dt | Repetitive rate of rise of on-state current after triggering | $dl_G/dt = 0.2\text{ A}/\mu\text{s}$ | | | | | |
| | | T2+ G+ | - | 50 | | | A/ μs |
| | | T2+ G- | - | 50 | | | A/ μs |
| | | T2- G- | - | 50 | | | A/ μs |
| | | T2- G+ | - | 10 | | | A/ μs |
| I_{GM} | Peak gate current | | - | 2 | | | A |
| V_{GM} | Peak gate voltage | | - | 5 | | | V |
| P_{GM} | Peak gate power | | - | 5 | | | W |
| $P_{G(AV)}$ | Average gate power | over any 20 ms period | - | 0.5 | | | W |
| T_{stg} | Storage temperature | | -40 | 150 | | | $^\circ C$ |
| T_j | Operating junction temperature | | - | 125 | | | $^\circ C$ |

¹ Although not recommended, off-state voltages up to 800V may be applied without damage, but the triac may switch to the on-state. The rate of rise of current should not exceed 3 A/ μs .

Triacs

BT136X series

ISOLATION LIMITING VALUE & CHARACTERISTIC $T_{hs} = 25\text{ }^{\circ}\text{C}$ unless otherwise specified

| SYMBOL | PARAMETER | CONDITIONS | MIN. | TYP. | MAX. | UNIT |
|------------|--|--|------|------|------|------|
| V_{isol} | R.M.S. isolation voltage from all three terminals to external heatsink | $f = 50\text{-}60\text{ Hz}$; sinusoidal waveform; $R.H. \leq 65\%$; clean and dustfree | - | | 2500 | V |
| C_{isol} | Capacitance from T2 to external heatsink | $f = 1\text{ MHz}$ | - | 10 | - | pF |

THERMAL RESISTANCES

| SYMBOL | PARAMETER | CONDITIONS | MIN. | TYP. | MAX. | UNIT |
|----------------|---|--|------|------|------|------|
| $R_{th\ j-hs}$ | Thermal resistance junction to heatsink | full or half cycle with heatsink compound | - | - | 5.5 | K/W |
| $R_{th\ j-a}$ | Thermal resistance junction to ambient | without heatsink compound in free air | - | 55 | 7.2 | K/W |

STATIC CHARACTERISTICS $T_j = 25\text{ }^{\circ}\text{C}$ unless otherwise stated

| SYMBOL | PARAMETER | CONDITIONS | MIN. | TYP. | MAX. | | | UNIT |
|----------|---------------------------|--|------|------|------|------|------|------|
| I_{GT} | Gate trigger current | $V_D = 12\text{ V}$; $I_T = 0.1\text{ A}$ BT136X- T2+ G+ T2+ G- T2- G- T2- G+ | - | 5 | ... | ...F | ...G | mA |
| | | | - | 8 | 35 | 25 | 50 | |
| | | | - | 11 | 35 | 25 | 50 | |
| | | | - | 30 | 70 | 70 | 100 | |
| | | | - | 7 | 20 | 20 | 30 | |
| I_L | Latching current | $V_D = 12\text{ V}$; $I_{GT} = 0.1\text{ A}$ T2+ G+ T2+ G- T2- G- T2- G+ | - | 7 | 20 | 20 | 30 | mA |
| | | | - | 16 | 30 | 30 | 45 | |
| | | | - | 5 | 20 | 20 | 30 | |
| | | | - | 7 | 30 | 30 | 45 | |
| | | | - | 5 | 15 | 15 | 30 | |
| I_H | Holding current | $V_D = 12\text{ V}$; $I_{GT} = 0.1\text{ A}$ | - | 5 | 15 | 15 | 30 | mA |
| V_T | On-state voltage | $I_T = 5\text{ A}$ | - | 1.4 | 1.70 | | | V |
| V_{GT} | Gate trigger voltage | $V_D = 12\text{ V}$; $I_T = 0.1\text{ A}$ | - | 0.7 | 1.5 | | | V |
| | | $V_D = 400\text{ V}$; $I_T = 0.1\text{ A}$; $T_j = 125\text{ }^{\circ}\text{C}$ | 0.25 | 0.4 | - | | | V |
| I_D | Off-state leakage current | $V_D = V_{DRM(max)}$; $T_j = 125\text{ }^{\circ}\text{C}$ | - | 0.1 | 0.5 | | | mA |

Triacs

BT136X series

DYNAMIC CHARACTERISTICS $T_j = 25\text{ }^\circ\text{C}$ unless otherwise stated

| SYMBOL | PARAMETER | CONDITIONS | MIN. | | | TYP. | MAX. | UNIT |
|---------------|--|--|------|------|------|------|------|------------------|
| | | | ... | ...F | ...G | | | |
| dV_D/dt | Critical rate of rise of off-state voltage | BT136X- $V_{DM} = 67\% V_{DRM(max)}$; $T_j = 125\text{ }^\circ\text{C}$; exponential waveform; gate open circuit | 100 | 50 | 200 | 250 | - | V/ μs |
| dV_{com}/dt | Critical rate of change of commutating voltage | $V_{DM} = 400\text{ V}$; $T_j = 95\text{ }^\circ\text{C}$; $I_{T(RMS)} = 4\text{ A}$; $dl_{com}/dt = 1.8\text{ A/ms}$; gate open circuit | - | - | 10 | 50 | - | V/ μs |
| t_{gt} | Gate controlled turn-on time | $I_{TM} = 6\text{ A}$; $V_D = V_{DRM(max)}$; $I_G = 0.1\text{ A}$; $dl_G/dt = 5\text{ A}/\mu\text{s}$ | - | - | - | 2 | - | μs |

Triacs

BT136X series

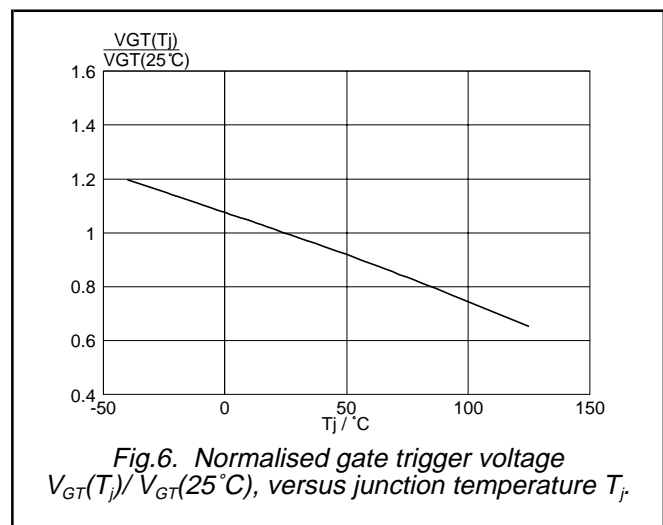
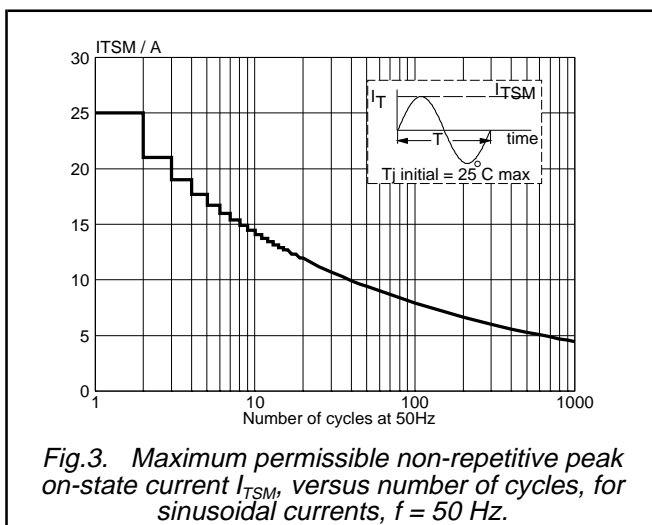
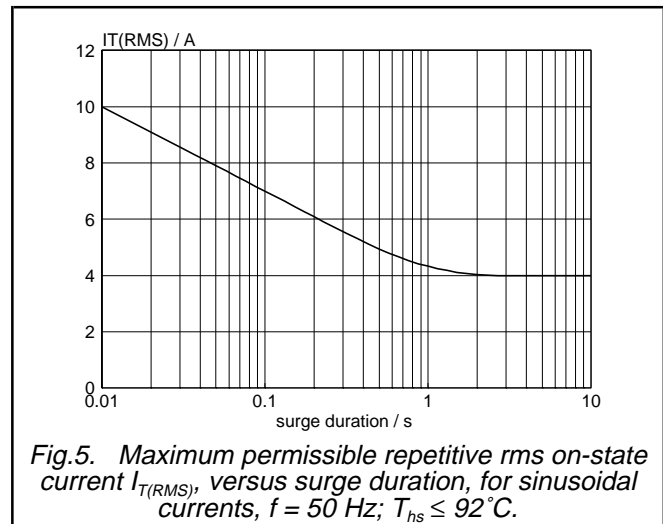
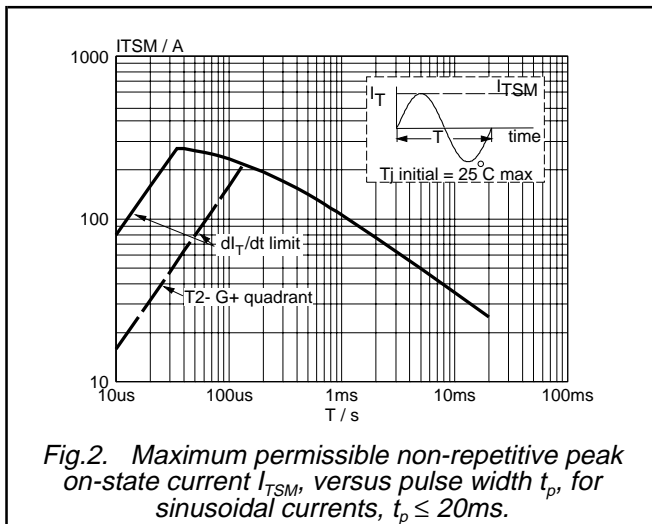
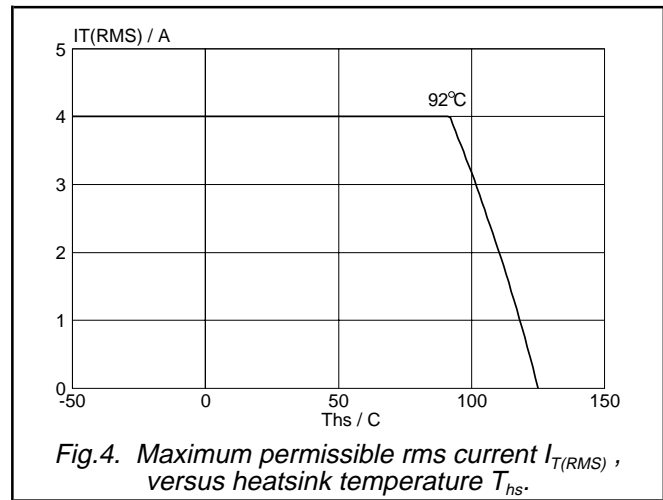
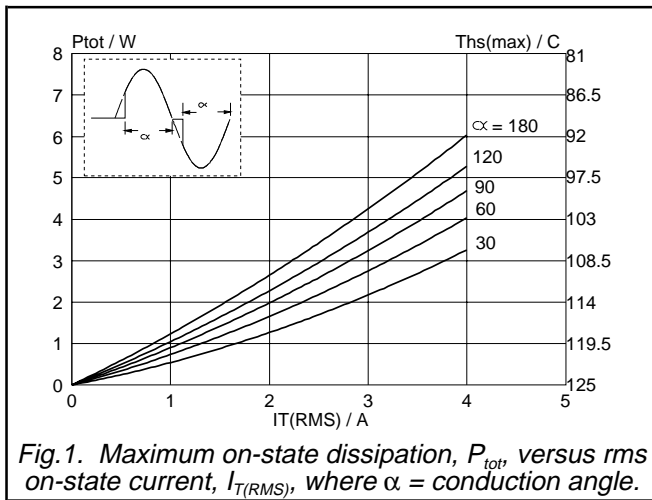

Triacs

BT136X series

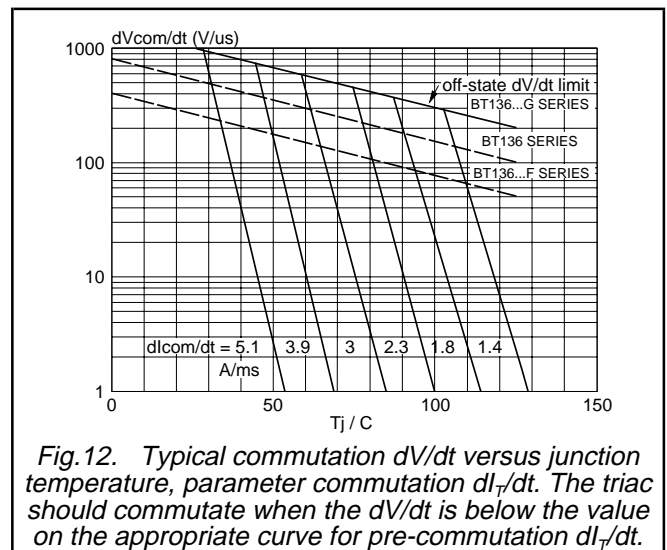
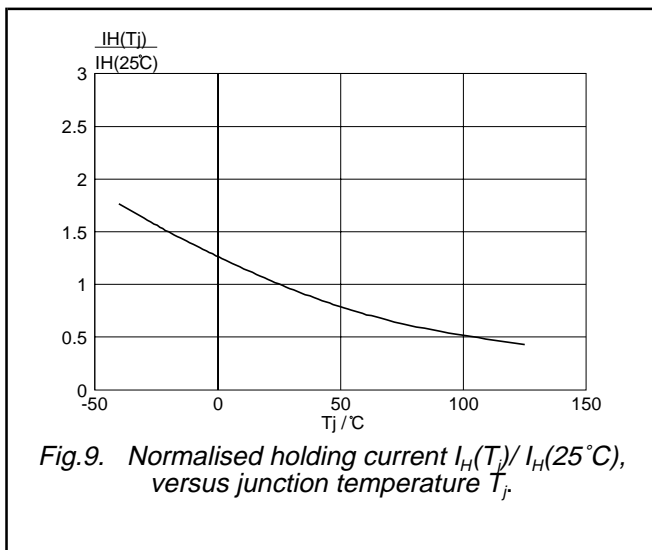
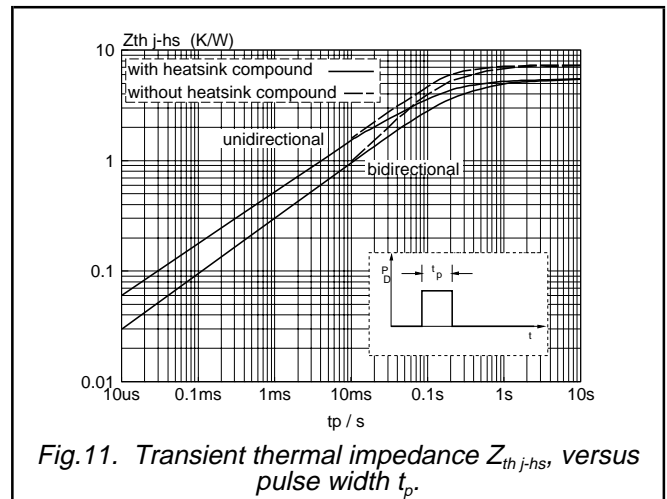
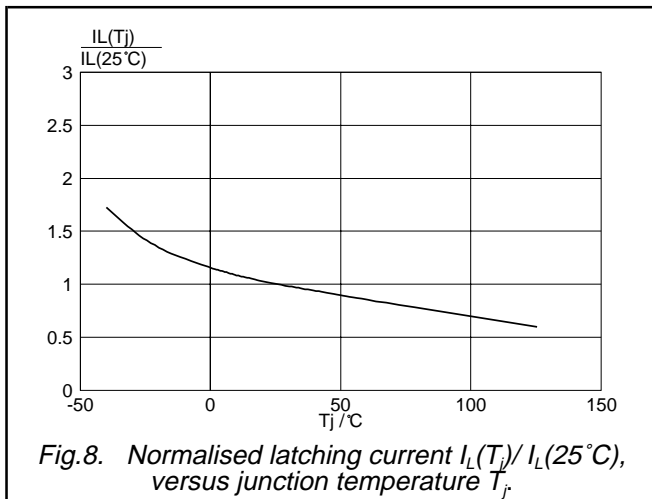
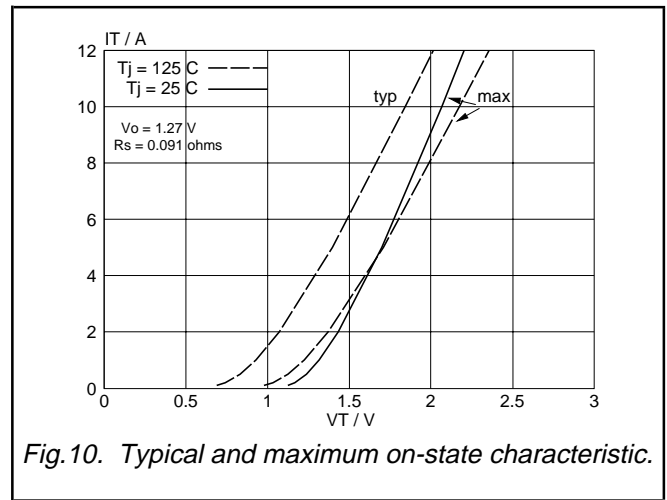
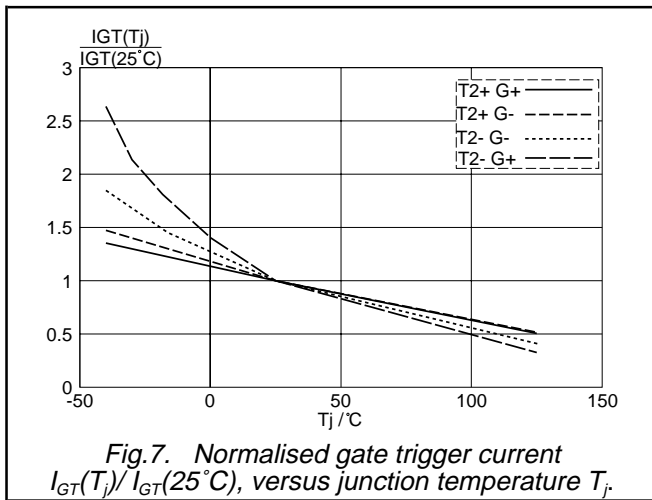

Triacs

BT136X series

MECHANICAL DATA

Dimensions in mm

Net Mass: 2 g

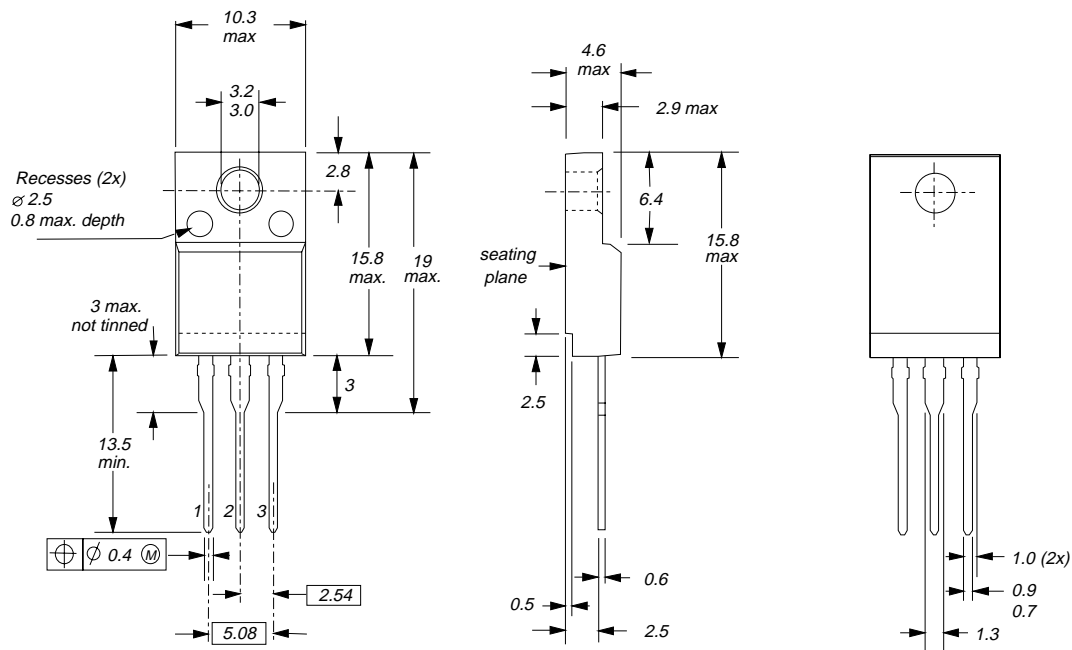

Fig. 13. SOT186A; The seating plane is electrically isolated from all terminals.

Notes

- 1. Refer to mounting instructions for F-pack envelopes.
- 2. Epoxy meets UL94 V0 at 1/8".

Triacs

BT136X series

DEFINITIONS

| | |
|--|---|
| Data sheet status | |
| Objective specification | This data sheet contains target or goal specifications for product development. |
| Preliminary specification | This data sheet contains preliminary data; supplementary data may be published later. |
| Product specification | This data sheet contains final product specifications. |
| Limiting values | |
| Limiting values are given in accordance with the Absolute Maximum Rating System (IEC 134). Stress above one or more of the limiting values may cause permanent damage to the device. These are stress ratings only and operation of the device at these or at any other conditions above those given in the Characteristics sections of this specification is not implied. Exposure to limiting values for extended periods may affect device reliability. | |
| Application information | |
| Where application information is given, it is advisory and does not form part of the specification. | |
| © Philips Electronics N.V. 1997 | |
| All rights are reserved. Reproduction in whole or in part is prohibited without the prior written consent of the copyright owner. | |
| The information presented in this document does not form part of any quotation or contract, it is believed to be accurate and reliable and may be changed without notice. No liability will be accepted by the publisher for any consequence of its use. Publication thereof does not convey nor imply any license under patent or other industrial or intellectual property rights. | |

LIFE SUPPORT APPLICATIONS

These products are not designed for use in life support appliances, devices or systems where malfunction of these products can be reasonably expected to result in personal injury. Philips customers using or selling these products for use in such applications do so at their own risk and agree to fully indemnify Philips for any damages resulting from such improper use or sale.