

TRIACS LOGIC LEVEL

DESCRIPTION

Passivated triacs in a plastic envelope, intended for use in applications requiring high bidirectional transient and blocking voltage capability and high thermal cycling performance. Typical applications include motor control, industrial and domestic lighting, heating voltages and static switching.

SYMBOL

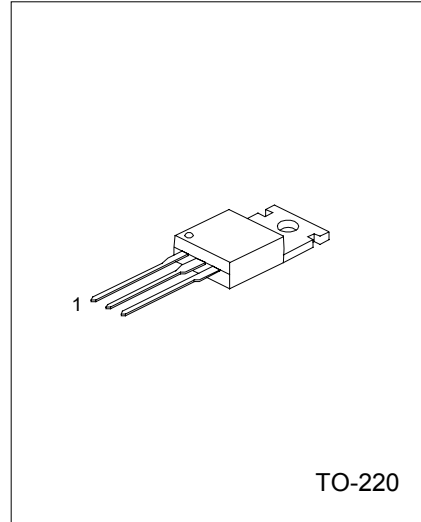
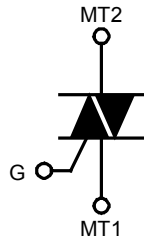

1:MT1 2:MT2 3:GATE

ABSOLUTE MAXIMUM RATINGS (T_j=25°C)

PARAMETER	SYMBOL	RATING	UNIT
Repetitive Peak Off State Voltage <small>www.DataSheet.U.com</small>	V _{DRM}	600 800	V
RMS On-state Current (Full sine wave; T _{mb} ≤99°C)	I _{T(RMS)}	12	A
Non-repetitive Peak. On-State Current (Full sine wave; T _j =25°C prior to surge)	I _{TSM}	95 105	A
t=20ms t=16.7ms			
I ² t For Fusing (t=10ms)	I ² t	45	A ² s
Repetitive Rate of Rise of On-state Current after Triggering (I _{TM} =20A; I _G =0.2A; dI _G /dt=0.2A/μs)	dI _T /dt	50 50 50 10	A/μs
T2+G+ T2+G- T2-G- T2-G+			
Peak Gate Voltage	V _{GM}	5	V
Peak Gate Current	I _{GM}	2	A
Peak Gate Power	P _{GM}	5	W
Average Gate Power	P _{G(AV)}	0.5	W
Operating Junction Temperature	T _j	125	°C
Storage Temperature	T _{stg}	-40~150	°C

*Although not recommended, off-state voltages up to 800V may be applied without damage, but the triac may switch to the on-state. The rate of rise of current should not exceed 15A/μs.

THERMAL RESISTANCES

PARAMETER	SYMBOL	MIN	TYP	MAX	UNIT
Thermal Resistance, Junction to Mounting Base Full cycle Half cycle	$R_{\theta j-mb}$			1.5 2.0	$^{\circ}\text{C}/\text{W}$
Thermal Resistance, Junction to Ambient In free air	$R_{\theta j-a}$		60	-	$^{\circ}\text{C}/\text{W}$

STATIC CHARACTERISTICS ($T_j=25^{\circ}\text{C}$, unless otherwise specified)

PARAMETER	SYMBOL	TEST CONDITIONS	MIN	TYP	MAX	UNIT
Gate Trigger Current T2+G+ T2+G- T2-G- T2-G+	I_{GT}	$V_D=12\text{V}$, $I_T=0.1\text{A}$		5 8 10 12	35 35 35 70	mA
Latching Current T2+G+ T2+G- T2-G- T2-G+	I_L	$V_D=12\text{V}$, $I_{GT}=0.1\text{A}$		7 20 8 10	40 60 40 60	mA
Holding Current	I_H	$V_D=12\text{V}$, $I_{GT}=0.1\text{A}$		6	30	mA
On-State Voltage	V_T	$I_T=15\text{A}$		1.4	1.65	V
Gate Trigger Voltage	V_{GT}	$V_D=12\text{V}$, $I_T=0.1\text{A}$ $V_D=400\text{V}$, $I_T=0.1\text{A}$, $T_j=125^{\circ}\text{C}$	0.25	0.7 0.4	1.5	V
Off-state Leakage Current	I_D	$V_D=V_{DRM(max)}$, $T_j=125^{\circ}\text{C}$		0.1	0.5	mA

DYNAMIC CHARACTERISTICS ($T_j=25^{\circ}\text{C}$, unless otherwise specified)

PARAMETER	SYMBOL	TEST CONDITIONS	MIN	TYP	MAX	UNIT
Critical Rate Of Rise Of Off-State Voltage	dV_D/dt	$V_{DM}=67\% V_{DRM(max)}$, $T_j=125^{\circ}\text{C}$ Exponential waveform, Gate open circuit	100	250		$\text{V}/\mu\text{s}$
Critical Rate Of Change Of Commutating Voltage	dV_{com}/dt	$V_{DM}=400\text{V}$, $T_j=95^{\circ}\text{C}$, $I_{T(RMS)}=12\text{A}$ $dI_{com}/dt=5.4\text{A}/\text{ms}$, Gate open circuit		20		$\text{V}/\mu\text{s}$
Gate Controlled Turn-on Time	t_{gt}	$I_{TM}=16\text{A}$, $V_D=V_{DRM(max)}$, $I_G=0.1\text{A}$ $dI_G/dt=5\text{A}/\mu\text{s}$		2		μs

TYPICAL CHARACTERISTICS

Figure 1. Maximum on-state Dissipation, P_{tot} vs RMS On-state Current, $I_T(RMS)$, Where α = conduction Angle.

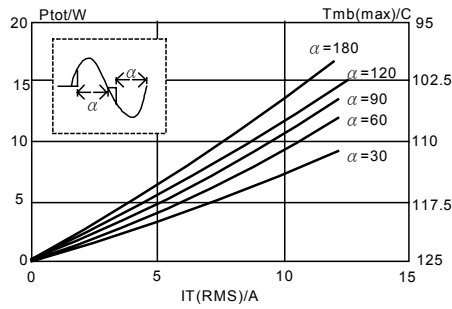

Figure 4. Maximum Permissible RMS Current $I_T(RMS)$ vs mounting base Temperature T_{mb}

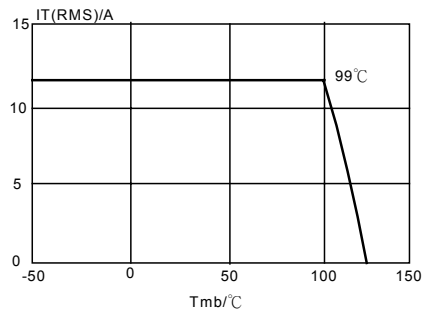

Figure 2. Maximum Permissible Non-repetitive Peak On-state Current I_{TSM} , vs Pulse Width t_p , for Sinusoidal Currents, $t_p \approx 20ms$

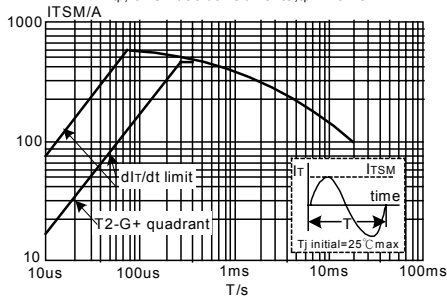

Figure 5. Maximum Permissible Repetitive RMS on-state Current $I_T(RMS)$, vs Surge Duration, for Sinusoidal Currents, $f=50Hz$, $T_{mb} \approx 99^{\circ}C$

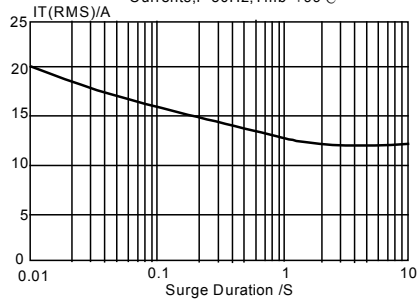

Figure 3. Maximum Permissible Non-Repetitive peak on-state Current I_{TSM} , vs Number of Cycles, for Sinusoidal Currents, $f=50Hz$

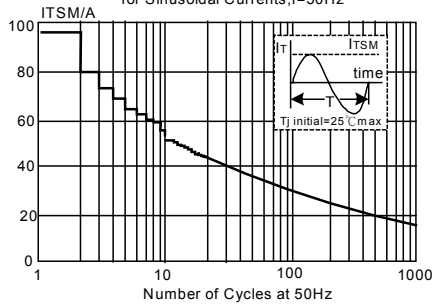
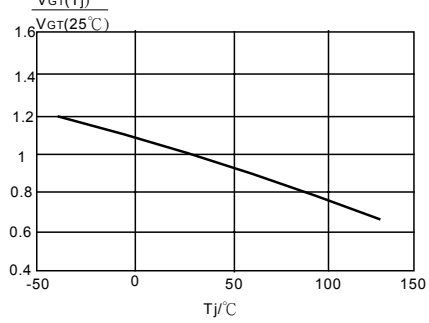
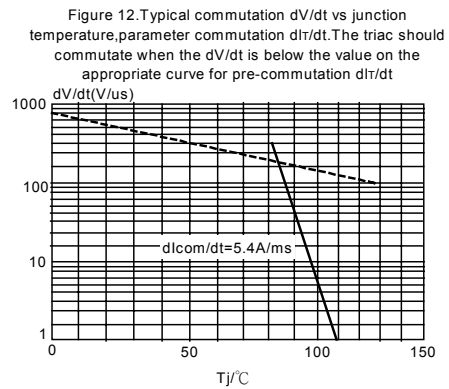
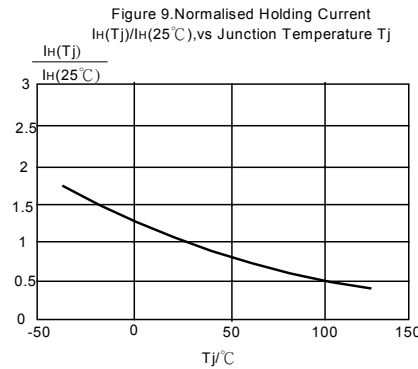
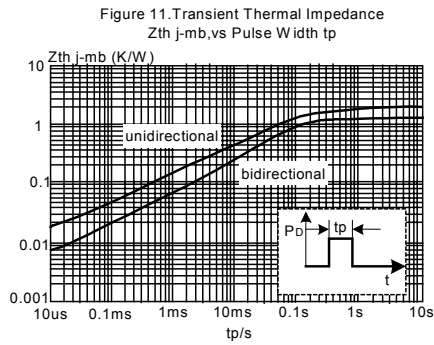
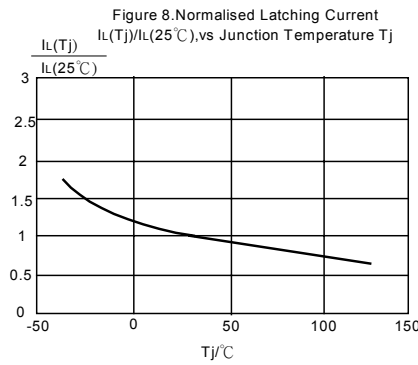
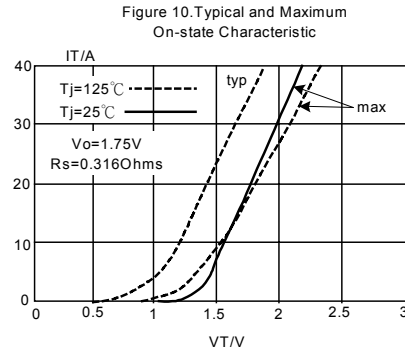
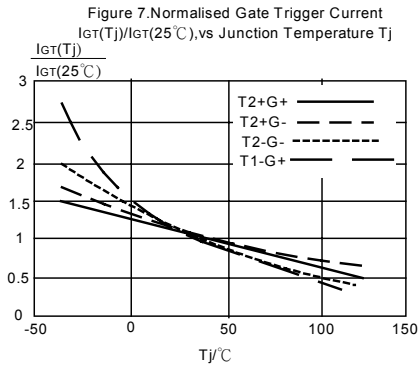

Figure 6. Normalised Gate Trigger Voltage $V_{GT}(T_j)/V_{GT}(25^{\circ}C)$, vs Junction Temperature T_j





UTC assumes no responsibility for equipment failures that result from using products at values that exceed, even momentarily, rated values (such as maximum ratings, operating condition ranges, or other parameters) listed in products specifications of any and all UTC products described or contained herein. UTC products are not designed for use in life support appliances, devices or systems where malfunction of these products can be reasonably expected to result in personal injury. Reproduction in whole or in part is prohibited without the prior written consent of the copyright owner. The information presented in this document does not form part of any quotation or contract, is believed to be accurate and reliable and may be changed without notice.