



BT169

SCR

SCRS

DESCRIPTION

Passivated, sensitive gate thyristors in a plastic envelope, intended for use in general purpose switching and phase control applications. These devices are intended to be interfaced directly to microcontrollers, logic integrated circuits and other low power gate trigger circuits.

SYMBOL

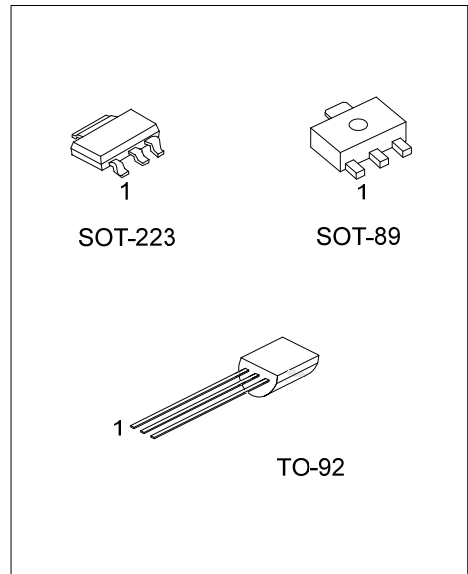
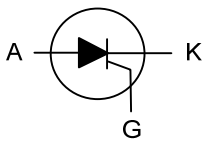

ORDERING INFORMATION

Ordering Number		Package	Pin Assignment			Packing
Lead Free	Halogen Free		1	2	3	
BT169BL-T92-B	BT169BG-T92-B	TO-92	K	G	A	Tape Box
BT169BL-T92-K	BT169BG-T92-K	TO-92	K	G	A	Bulk
BT169DL-AB3-R	BT169DG-AB3-R	SOT-89	G	A	K	Tape Reel
BT169DL-T92-B	BT169DG-T92-B	TO-92	K	G	A	Tape Box
BT169DL-T92-K	BT169DG-T92-K	TO-92	K	G	A	Bulk
BT169EL-T92-B	BT169EG-T92-B	TO-92	K	G	A	Tape Box
BT169EL-92-K	BT169EG-T92-K	TO-92	K	G	A	Bulk
BT169GL-T92-B	BT169GP-T92-B	TO-92	K	G	A	Tape Box
BT169GL-T92-K	BT169GP-T92-K	TO-92	K	G	A	Bulk
BT169HL-AA3-R	BT169HG-AA3-R	SOT-223	K	A	G	Tape Reel
BT169HL-T92-B	BT169HG-T92-B	TO-92	K	G	A	Tape Box
BT169HL-T92-K	BT169HG-T92-K	TO-92	K	G	A	Bulk

Note: Pin Assignment: K: Cathode G: Gate A: Anode

<p>BT169xG-T92-B</p> <ul style="list-style-type: none"> (1)Packing Type (2)Package Type (3)Green Package (4)Repetitive Peak Off-State Voltages 	<ul style="list-style-type: none"> (1) B: Tape Box, K: Bulk, R: Tape Reel (2) AA3: SOT-223, T92: TO-92 (3) G: Halogen Free and Lead Free, L: Lead Free P: Halogen Free(for BT169G) (4) x: refer to Quick Reference data
--	---

■ MARKING

Package	MARKING
SOT-223	
SOT-89	
TO-92	
TO-92 (For BT169G)	

■ QUICK REFERENCE DATA

PARAMETER	SYMBOL	BT169B	BT169D	BT169E	BT169G	BT169H	UNIT
		MAX	MAX	MAX	MAX	MAX	MAX
Repetitive Peak Off-State Voltages	V_{DRM}, V_{RRM}	200	400	500	600	800	V
Average On-State Current	$I_{T(AV)}$	0.5	0.5	0.5	0.5	0.5	A
RMS On-State Current	$I_{T(RMS)}$	0.8	0.8	0.8	0.8	0.8	A
Non-Repetitive Peak On-State Current	I_{TSM}	8	8	8	8	8	A

■ ABSOLUTE MAXIMUM RATINGS

PARAMETER		SYMBOL	RATINGS	UNIT
Repetitive Peak Off-State Voltages(Note 2)	BT169B	V_{DRM}, V_{RRM}	200	V
	BT169D		400	
	BT169E		500	
	BT169G		600	
	BT169H		800	
Peak Gate Voltage		V_{GM}	5	V
Peak Reverse Gate Voltage		V_{RGM}	5	V
Peak Gate Current		I_{GM}	1	A
Average On-State Current (Half Sine Wave, $T_{LEAD} \leq 83^{\circ}C$)		$I_{T(AV)}$	0.5	A
RMS On-State Current (All Conduction Angles)		$I_{T(RMS)}$	0.8	A
Non-Repetitive Peak On-State Current (Half Sine Wave, $T_J=25^{\circ}C$ Prior to Surge)	$t=10ms$	I_{TSM}	8	A
	$t=8.3ms$		9	A
I^2t For Fusing ($t=10ms$)		I^2t	0.32	A^2S
Repetitive Rate of Rise of On-State Current After Triggering ($I_{TM}=2A, I_G=10mA, dI_G/dt=100mA/\mu s$)		dI_T/dt	50	$A/\mu s$
Peak Gate Power		P_{GM}	2	W
Average Gate Power (Over any 20 ms period)		$P_{G(AV)}$	0.1	W
Junction Temperature		T_J	+125	$^{\circ}C$
Storage Temperature		T_{STG}	-40 ~ +150	$^{\circ}C$

Note: 1. Absolute maximum ratings are those values beyond which the device could be permanently damaged.

Absolute maximum ratings are stress ratings only and functional device operation is not implied.

2. 1 Although not recommended, off-state voltages up to 800V may be applied without damage, but the thyristor may switch to the on-state. The rate of rise of current should not exceed 15 A/ μs .

■ THERMAL DATA

PARAMETER		SYMBOL	RATINGS	UNIT
Thermal Resistance Junction to Ambient (typ.)	SOT-223	θ_{JA}	150	$^{\circ}C/W$
	SOT-89		200	$^{\circ}C/W$
	TO-92		180	$^{\circ}C/W$

Note: pcb mounted, lead length=4mm

■ ELECTRICAL CHARACTERISTICS ($T_J=25^\circ\text{C}$, unless otherwise specified)

PARAMETER	SYMBOL	TSET CONDITIONS	MIN	TYP	MAX	UNIT
STATIC CHARACTERISTICS						
Gate Trigger Current	I_{GT}	$V_D=12\text{V}$, $I_T=10\text{ mA}$, gate open circuit	25		200	μA
Latching Current	I_L	$V_D=12\text{V}$, $I_{GT}=0.5\text{mA}$, $R_{GK}=1\text{k}\Omega$		2	6	mA
Holding Current	I_H	$V_D=12\text{V}$, $I_{GT}=0.5\text{mA}$, $R_{GK}=1\text{k}\Omega$		2	5	mA
On-State Voltage	V_T	$I_T=1\text{A}$		1.2	1.35	V
Gate Trigger Voltage	V_{GT}	$V_D=12\text{V}$, $I_T=10\text{mA}$, gate open circuit $V_D=V_{DRM(\text{MAX})}$, $I_T=10\text{mA}$, $T_J=125^\circ\text{C}$, gate open circuit	0.2	0.5 0.3	0.8	V
Off-State Leakage Current	I_D, I_R	$V_D=V_{DRM(\text{MAX})}$, $V_R=V_{RRM(\text{MAX})}$, $T_J=125^\circ\text{C}$, $R_{GK}=1\text{k}\Omega$		0.05	0.1	mA
DYNAMIC CHARACTERISTICS						
Critical Rate of Rise of Off-State Voltage	dV_D/dt	$V_{DM}=67\% V_{DRM(\text{MAX})}$, $T_J=125^\circ\text{C}$, exponential waveform, $R_{GK}=1\text{k}\Omega$	500	800		$\text{V}/\mu\text{s}$
Gate Controlled Turn-On Time	t_{gt}	$I_{TM}=2\text{A}$, $V_D=V_{DRM(\text{MAX})}$, $I_G=10\text{mA}$, $dI_G/dt=0.1\text{A}/\mu\text{s}$		2		μs
Circuit Commutated Turn-Off Time	t_q	$V_D=67\% V_{DRM(\text{MAX})}$, $T_J=125^\circ\text{C}$, $I_{TM}=1.6\text{A}$, $V_R=35\text{V}$, $dI_{TM}/dt=30\text{A}/\mu\text{s}$, $V_D/dt=2\text{V}/\mu\text{s}$, $R_{GK}=1\text{k}\Omega$		100		μs

■ TYPICAL CHARACTERISTICS

Maximum On-State Dissipation vs. Average On-State Current

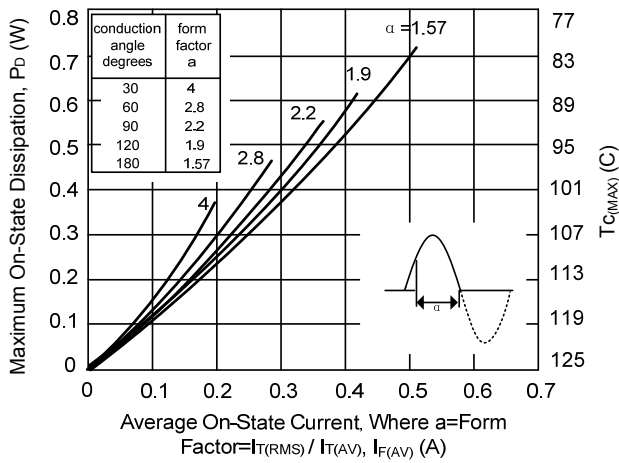

Maximum Permissible Non-Repetitive Peak On-State Current vs. Number Of Cycles

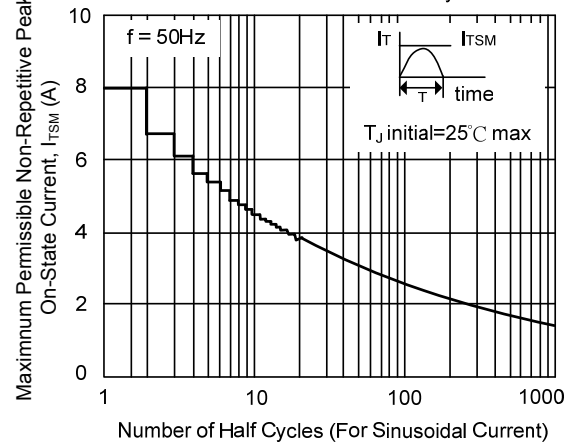

Maximum Permissible Non-Repetitive Peak On-State Current vs. Pulse Width tp, For Sinusoidal Current

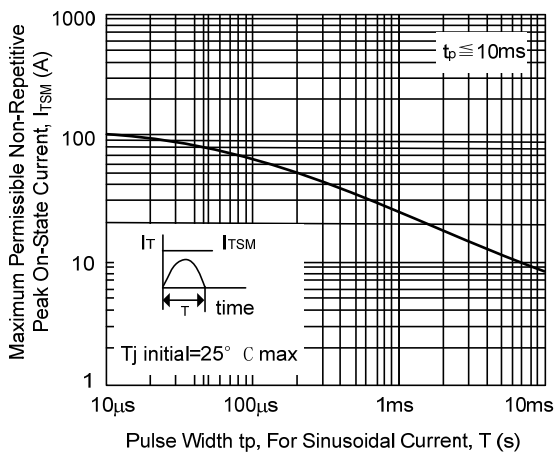

Maximum Permissible Repetitive RMS On-State Current vs. Surge Duration, For Sinusoidal Currents

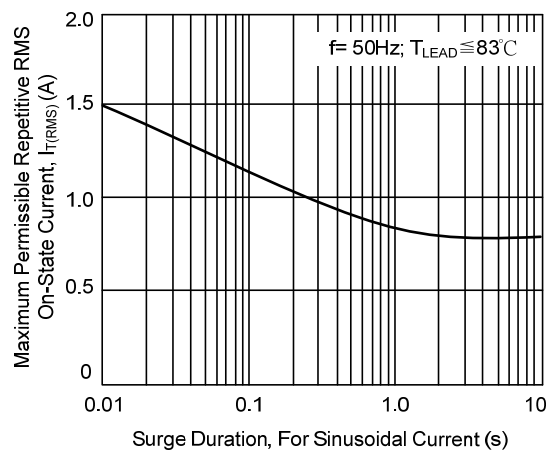

Maximum Permissible RMS Current vs. Lead Temperature

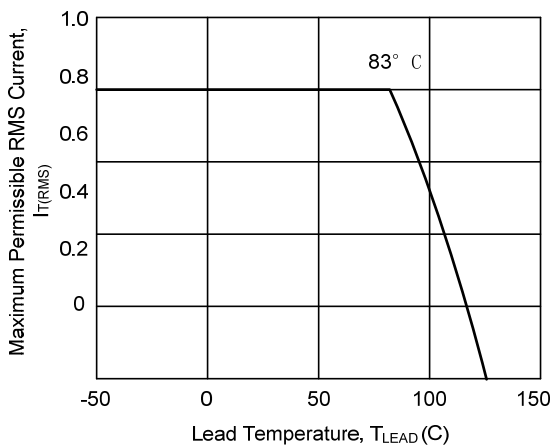

Normalised Gate Trigger Voltage vs. Junction Temperature

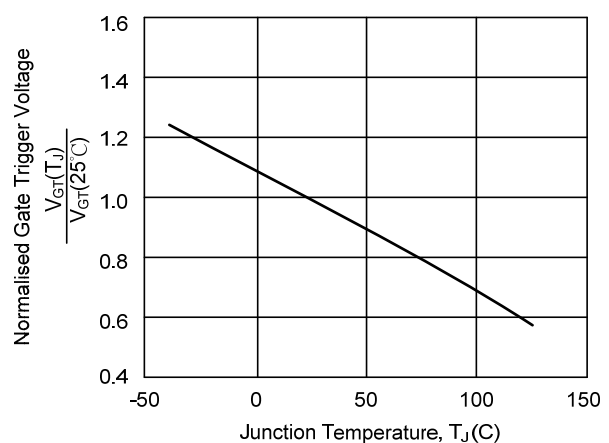

■ TYPICAL CHARACTERISTICS (Cont.)

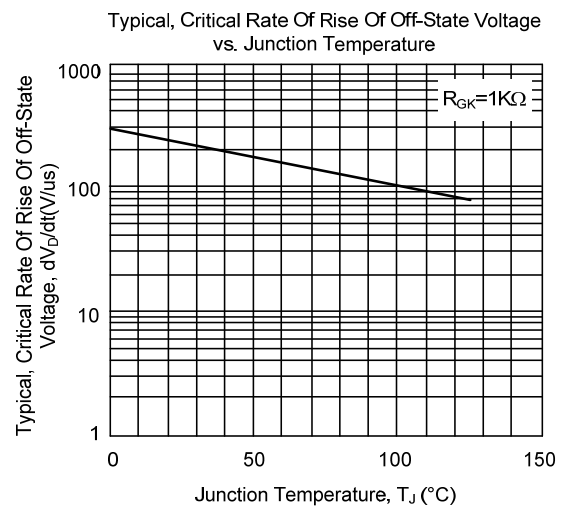
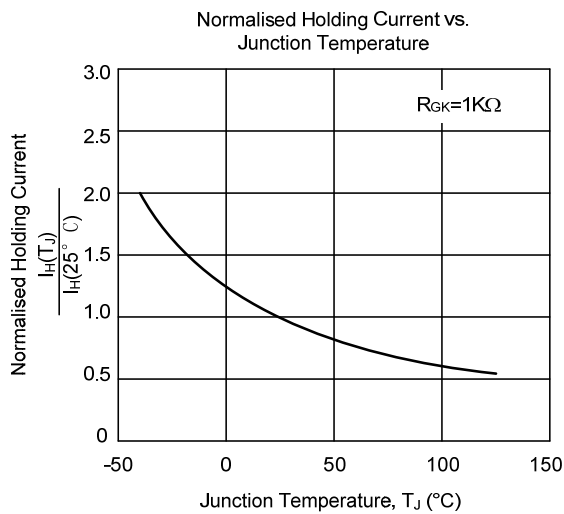
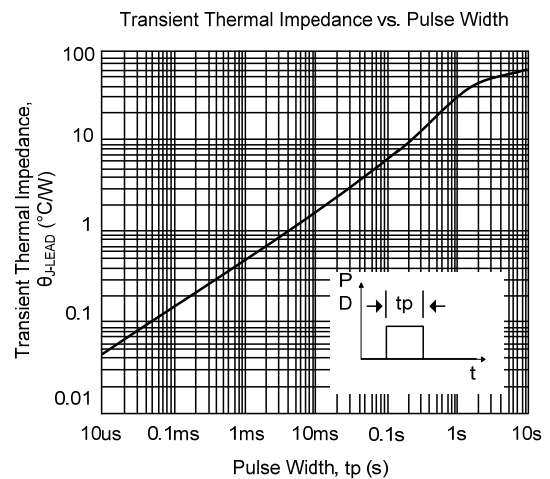
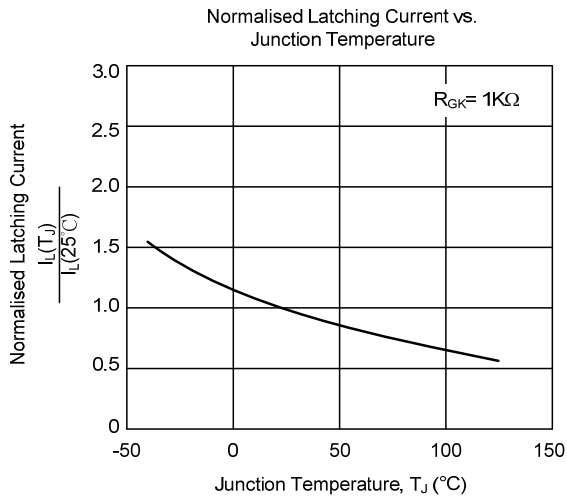
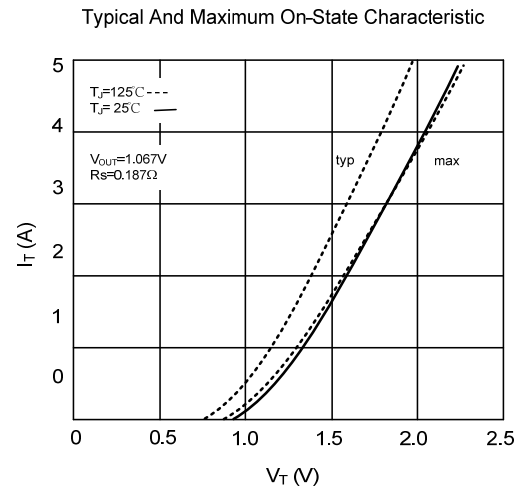
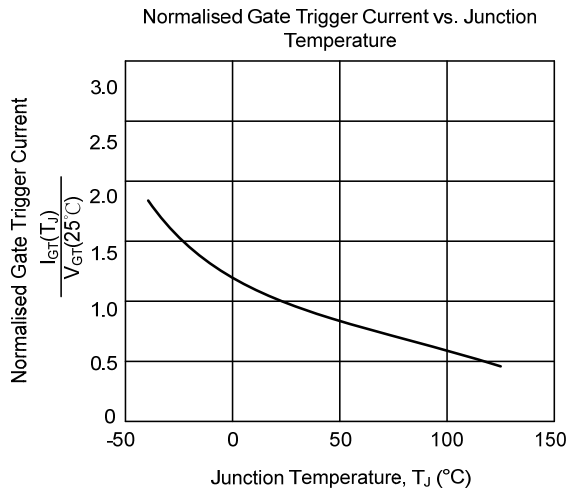

UTC assumes no responsibility for equipment failures that result from using products at values that exceed, even momentarily, rated values (such as maximum ratings, operating condition ranges, or other parameters) listed in products specifications of any and all UTC products described or contained herein. UTC products are not designed for use in life support appliances, devices or systems where malfunction of these products can be reasonably expected to result in personal injury. Reproduction in whole or in part is prohibited without the prior written consent of the copyright owner. UTC reserves the right to make changes to information published in this document, including without limitation specifications and product descriptions, at any time and without notice. This document supersedes and replaces all information supplied prior to the publication hereof.