

NPN Epitaxial Planar Transistor

BTC5103M3

Features

- High I_C , $I_{C(DC)}=5A$
- Low $V_{CE(sat)}$, 0.3V typically
- Good current gain linearity

Symbol

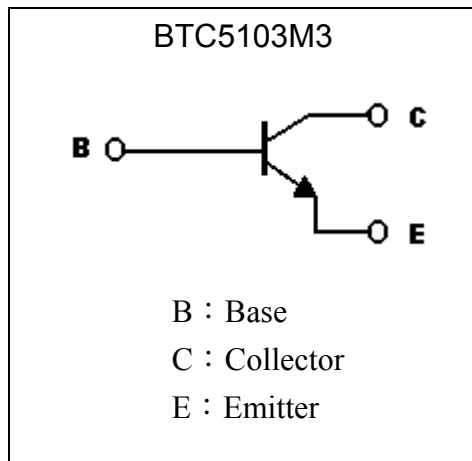

Outline

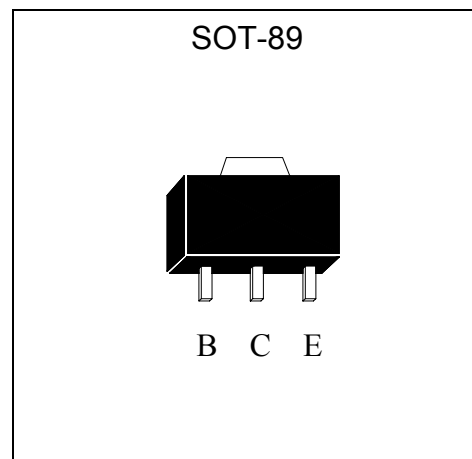

Absolute Maximum Ratings (Ta=25°C)

Parameter	Symbol	Limit	Unit
Collector-Base Voltage	V_{CBO}	80	V
Collector-Emitter Voltage	V_{CEO}	60	V
Emitter-Base Voltage	V_{EBO}	5	V
Collector Current (DC)	I_C	5	A
Collector Current (Pulse)	I_{CP}	10 (Note 1)	A
Power Dissipation	P_d	0.6	W
		1 (Note 2)	W
		2 (Note 3)	W
Thermal Resistance, Junction to Ambient	$R_{\theta JA}$	208	°C/W
		125 (Note 2)	°C/W
		62.5 (Note 3)	°C/W
Junction Temperature	T_j	150	°C
Storage Temperature	T_{stg}	-55~+150	°C

Note : 1. Single Pulse $P_w \leq 350\mu s$, Duty $\leq 2\%$.

2. When mounted on FR-4 PCB with area measuring $10 \times 10 \times 1$ mm

3. When mounted on ceramic with area measuring $40 \times 40 \times 1$ mm



Characteristics (Ta=25°C)

Symbol	Min.	Typ.	Max.	Unit	Test Conditions
BV _{CB0}	80	-	-	V	I _C =50μA, I _E =0
BV _{CE0}	60	-	-	V	I _C =1mA, I _B =0
BV _{EB0}	5	-	-	V	I _E =50μA, I _C =0
I _{CB0}	-	-	10	μA	V _{CB} =60V, I _E =0
I _{CE0}	-	-	5	mA	V _{CE} =60V, I _B =0
I _{EB0}	-	-	10	μA	V _{EB} =5V, I _C =0
*V _{CE(sat)}	-	0.3	1	V	I _C =2A, I _B =200mA
*V _{BE(sat)}	-	-	1.5	V	I _C =2A, I _B =200mA
*V _{BE(on)}	-	-	1.5	V	V _{CE} =2V, I _C =1A
*h _{FE 1}	82	-	390	-	V _{CE} =5V, I _C =500mA
*h _{FE 2}	80	-	-	-	V _{CE} =2V, I _C =1A
f _T	-	8	-	MHz	V _{CE} =5V, I _C =500mA, f=1MHz

*Pulse Test : Pulse Width ≤380μs, Duty Cycle≤2%

Classification Of hFE 1

Rank	P	Q	R
Range	82~180	120~270	180~390

Characteristic Curves

Current Gain vs Collector Current

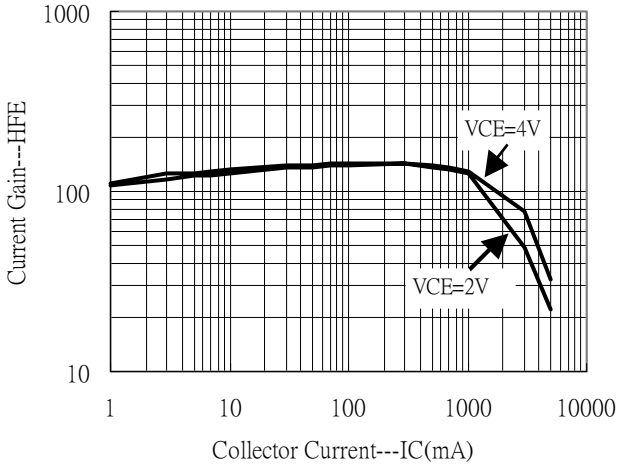

Saturation Voltage vs Collector Current

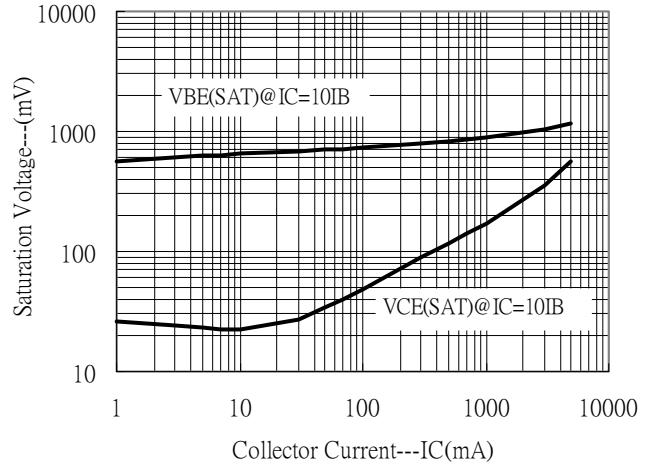

On Voltage vs Collector Current

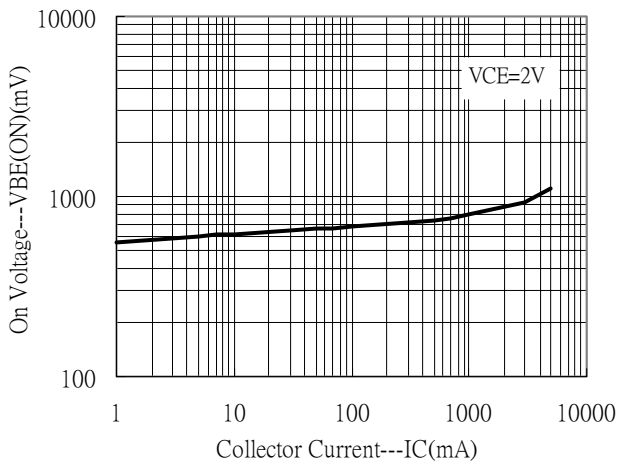

Power Derating Curves

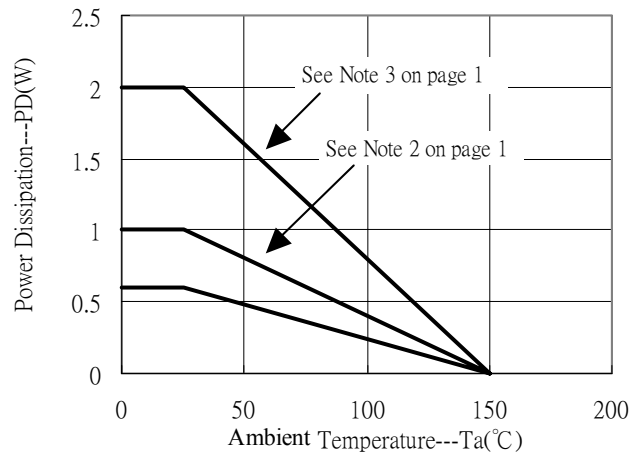

SOT-89 Dimension

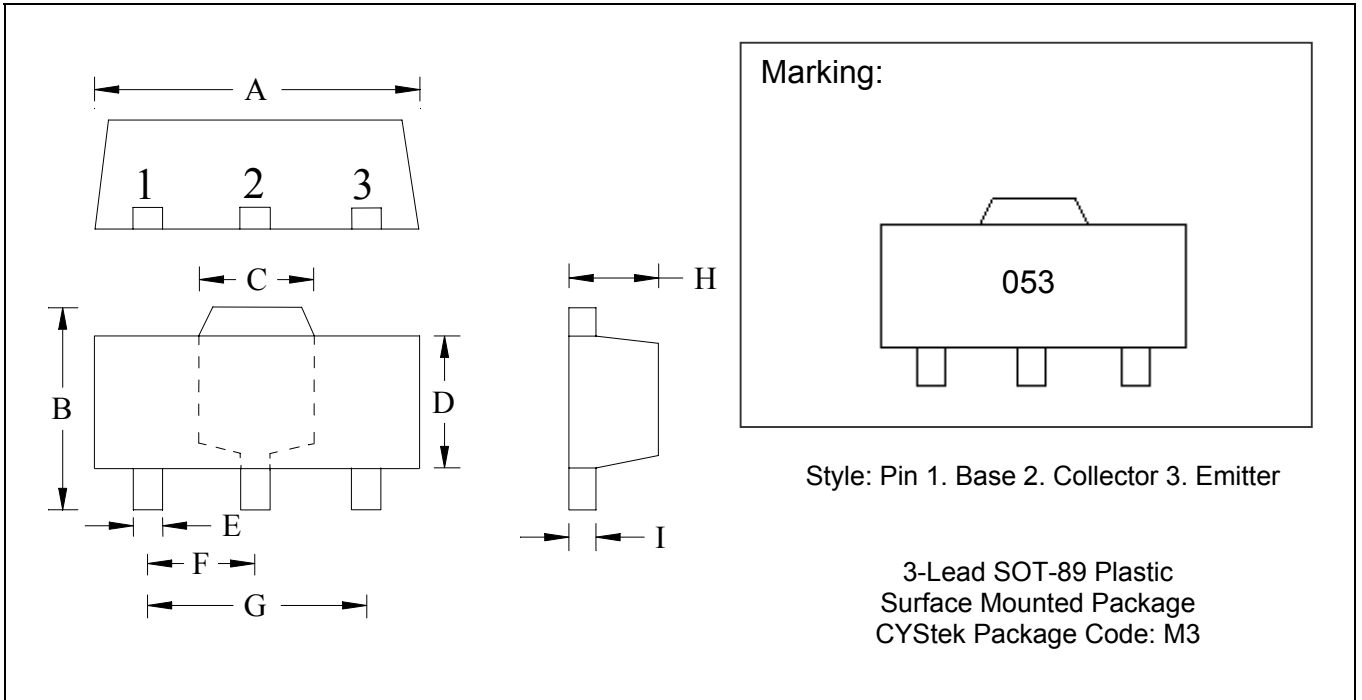

*: Typical

DIM	Inches		Millimeters		DIM	Inches		Millimeters	
	Min.	Max.	Min.	Max.		Min.	Max.	Min.	Max.
A	0.1732	0.1811	4.40	4.60	F	0.0583	0.0598	1.48	1.527
B	0.1594	0.1673	4.05	4.25	G	0.1165	0.1197	2.96	3.04
C	0.0591	0.0663	1.50	1.70	H	0.0551	0.0630	1.40	1.60
D	0.0945	0.1024	2.40	2.60	I	0.0138	0.0161	0.35	0.41
E	0.01417	0.0201	0.36	0.51					

Notes: 1.Controlling dimension: millimeters.
 2.Maximum lead thickness includes lead finish thickness, and minimum lead thickness is the minimum thickness of base material.
 3.If there is any question with packing specification or packing method, please contact your local CYStek sales office.

Material:

- Lead: 42 Alloy ; solder plating
- Mold Compound: Epoxy resin family, flammability solid burning class: UL94V-0

Important Notice:

- All rights are reserved. Reproduction in whole or in part is prohibited without the prior written approval of CYStek.
- CYStek reserves the right to make changes to its products without notice.
- CYStek **semiconductor products are not warranted to be suitable for use in Life-Support Applications, or systems.**
- CYStek assumes no liability for any consequence of customer product design, infringement of patents, or application assistance.